



Metasol

Meta Solution

Low voltage circuit breakers



Leader in Electrics & Automation

***Upgraded for the global
best worth!***

Metasol

Molded case circuit breaker / Earth leakage circuit breaker

Marking and configuration	16
External configuration	18
Quick selection table (Molded Case Circuit Breakers)	20
Quick selection table (Earth Leakage Circuit Breakers)	28
Ratings	32
Accessories	72
Type numbering system	86
Characteristics curves	87
Dimensions	92
Technical Information	109



Metasol

Meta solution



MCCB = ELCB

Metasol

Molded case circuit breaker / Earth leakage circuit breaker

Upgrade of Meta-MEC series

... **Metasol** Low voltage circuit breaker

- $I_{cs} = 100\% \times I_{cu}$
- $U_i = 750V$
- $U_{imp} = 8kV$



• *Compatible and differentiated design*

- Compatible with the Meta-MEC
- Outlook differentiated design

• *Same External dimension with MCCB and ELCB*

• *Upgrade the coordination*

- Upgrade the coordination with Susol / Meta-MEC mass capacity

• *Upgrade breaking capacity*

- N100AF : 10 \Rightarrow 18kA
- S125AF : 25 \Rightarrow 37kA
- S250AF : 25 \Rightarrow 37kA
- H250AF : 35 \Rightarrow 50kA
- N400AF : 25 \Rightarrow 37kA
- S400AF : 35 \Rightarrow 50kA
- S800AF : 50 \Rightarrow 65kA

• *$I_{cs} = 100\% I_{cu}$*

Metasol MCCB/ELCB



Ics = 100% Icu

Metasol MCCB

Upgrade breaking capacity

460V

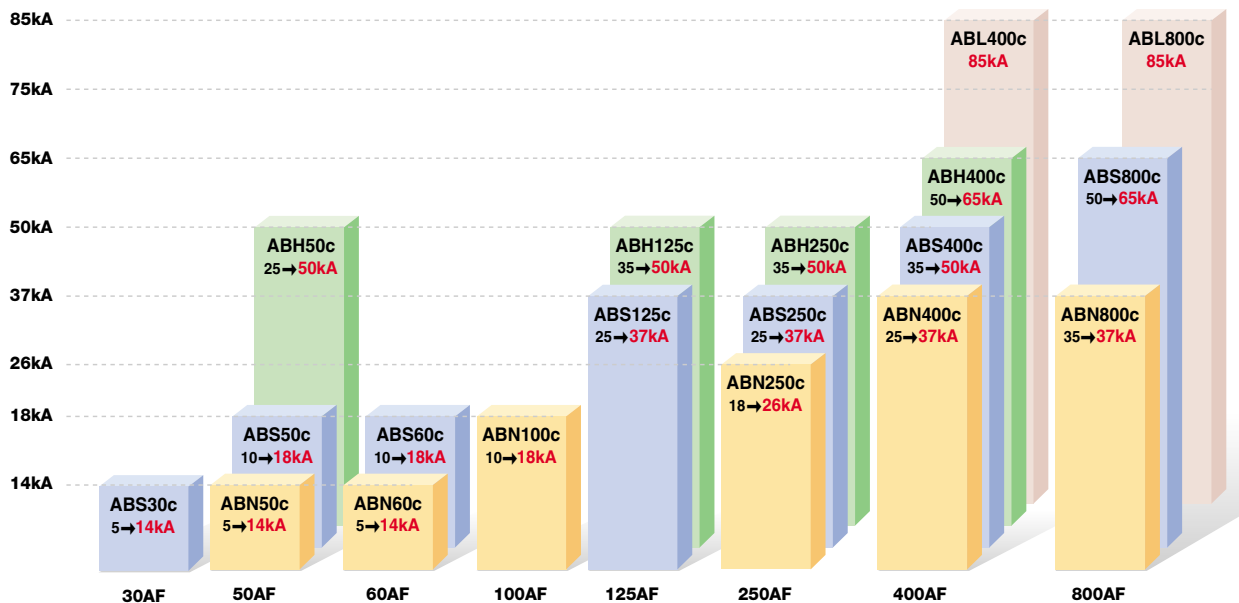

Short-circuit breaking capacity

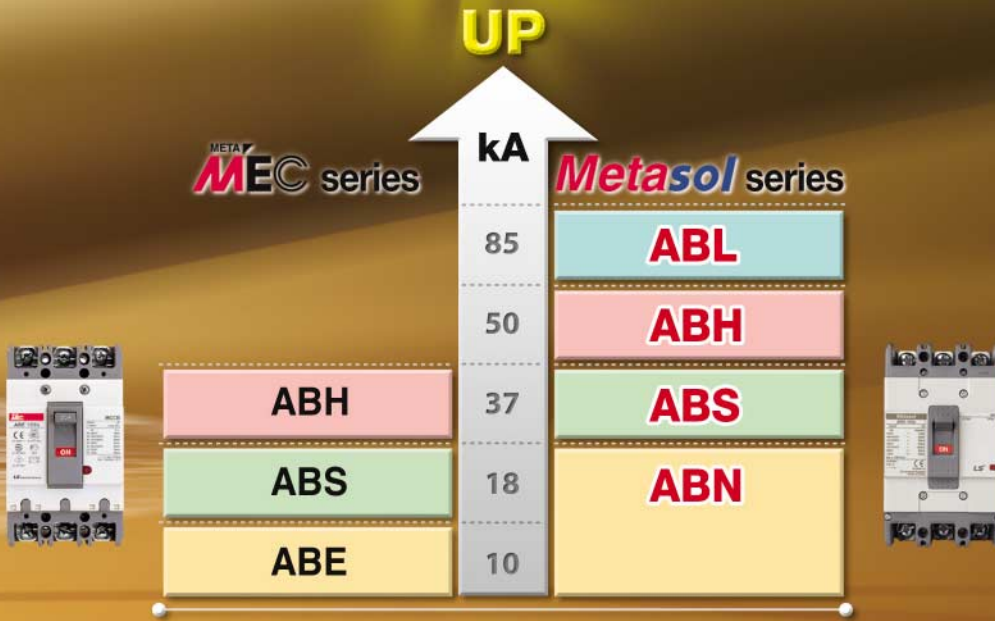

Upgrade breaking capacity

- N100AF :
10 → **18kA**
- S125AF :
25 → **37kA**
- S250AF :
25 → **37kA**
- H250AF :
35 → **50kA**
- N400AF :
25 → **37kA**
- S400AF :
35 → **50kA**
- S630AF :
50 → **65kA**
- S800AF :
50 → **65kA**

Metasol ELCB

Upgrade breaking capacity

460V

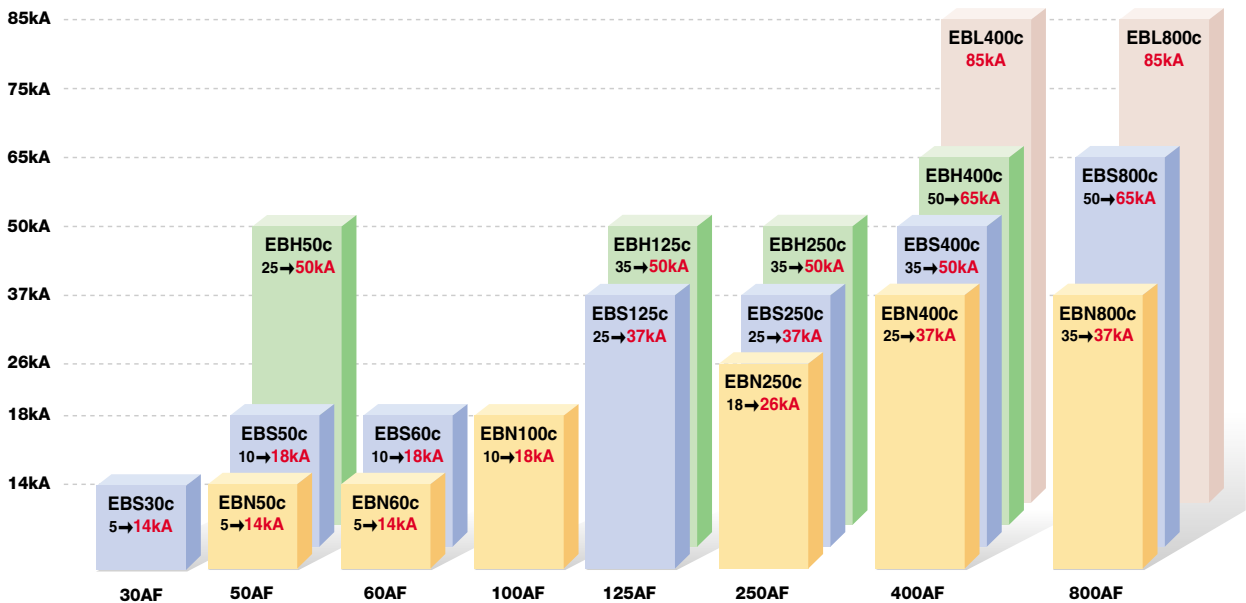

Metasol MCCB/ELCB Compatible and Standard

- 100% compatible with Meta-MEC Series.
- Standardized dimension (Depth, Cutout) when the panel is made.

MCCB (Molded Case Circuit Breaker)



105 × 165 × 60mm



90 × 155 × 60mm



75 × 130 × 60mm

Metasol MCCB

AF Type	30AF	50AF	60AF	100AF	125AF	250AF	400AF	800AF
ABN		ABN50c 14kA	ABN60c 14kA	ABN100c 18kA		ABN250c 26kA	ABN400c 37kA	ABN800c 37kA
ABS	ABS30c 14kA	ABS50c 18kA	ABS60c 18kA		ABS125c 37kA	ABS250c 37kA	ABS400c 50kA	ABS800c 65kA
ABH		ABH50c 50kA			ABH125c 50kA	ABH250c 50kA	ABH400c 65kA	
ABL							ABL400c 85kA	ABL800c 85kA

Note) Dimension is for 3 pole and breaking capacity is for AC460V.

- Same external dimension with MCCB and ELCB.

ELCB (Earth leakage circuit breaker)



Metasol ELCB

AF Type	30AF	50AF	60AF	100AF	125AF	250AF	400AF	800AF
EBN		EBN50c 14kA	EBN60c 14kA	EBN100c 18kA		EBN250c 26kA	EBN400c 37kA	EBN800c 37kA
EBS	EBS30c 14kA	EBS50c 18kA	EBS60c 18kA		EBS125c 37kA	EBS250c 37kA	EBS400c 50kA	EBS800c 65kA
EBH		EBH50c 50kA			EBH125c 50kA	EBH250c 50kA	EBH400c 65kA	
EBL							EBL400c 85kA	EBL800c 85kA

Note) Dimension is for 3 pole and breaking capacity is for AC460V.

Metasol MCCB/ELCB System overview

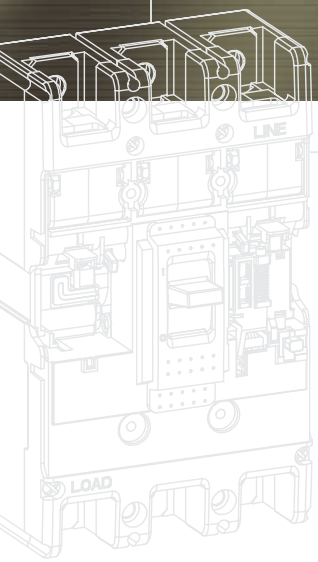

■ Various installable Accessories

- Wider range of installable accessories compared to Meta MEC series.
- Composed of User Friendly Method.

System overview

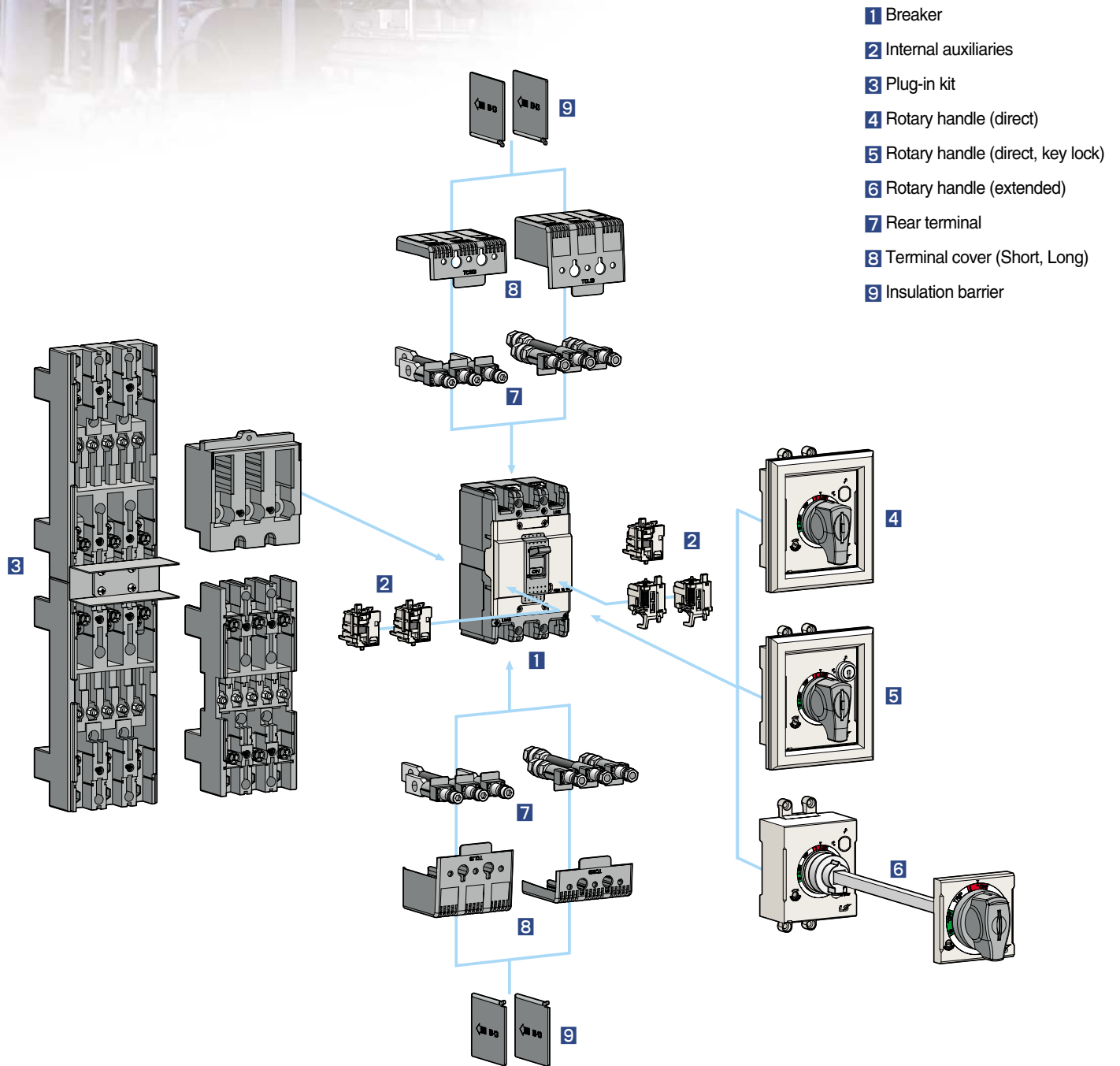

Metasol MCCB/ELCB Internal accessories

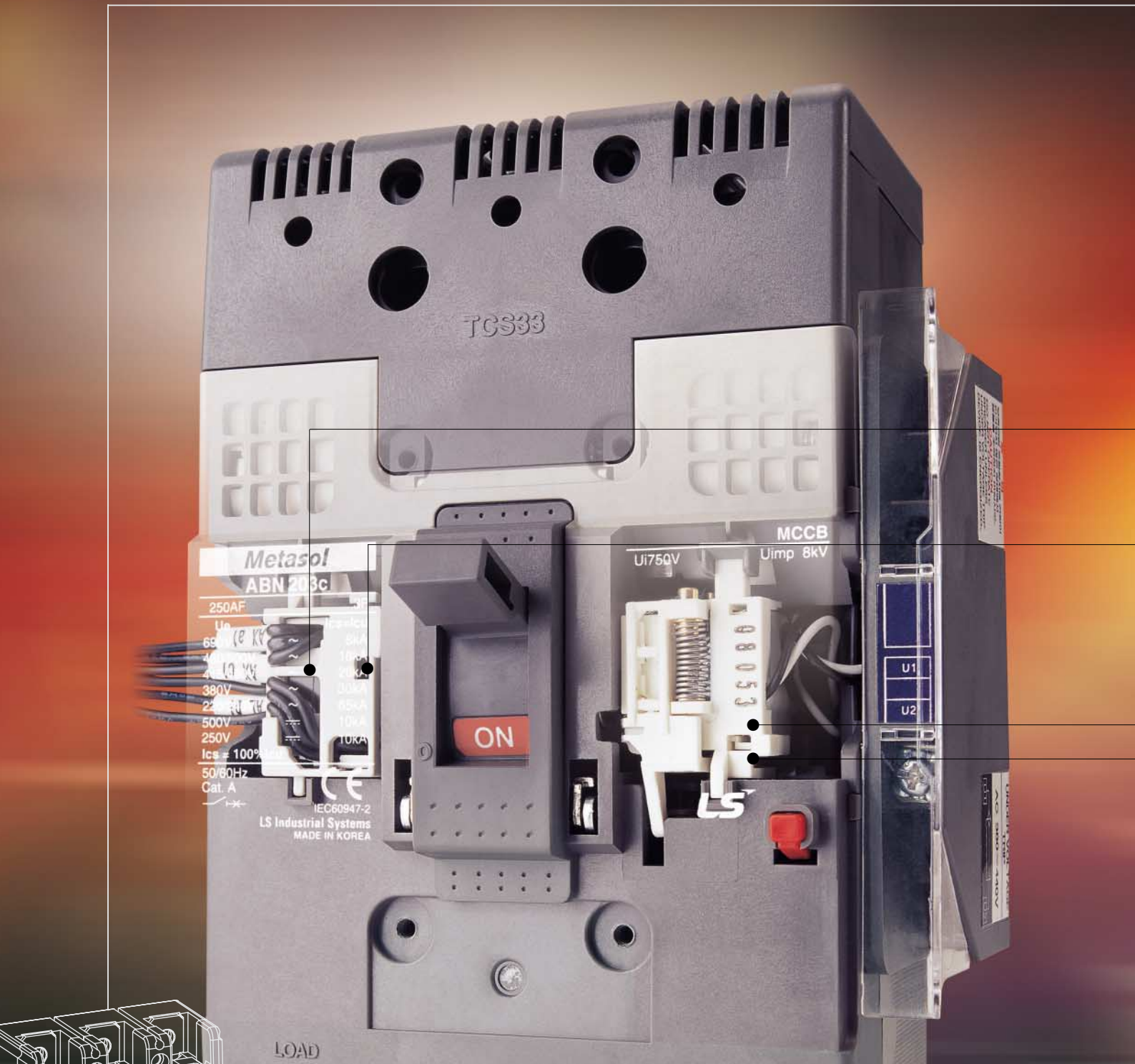

Internal Accessories

Internal Accessories can be commonly used in all Metasol MCCB and ELCB
(Notice: Exception of SHT, UVT in ELCB)

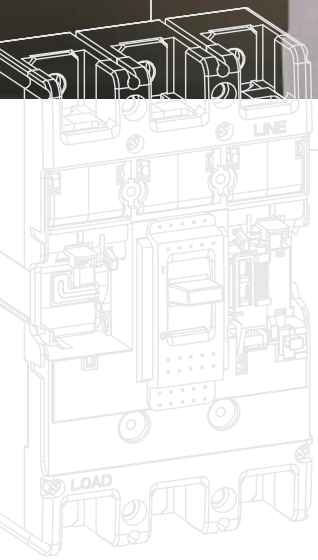

Common use to all Metasol MCCBs and ELCBs



Alarm Switch (AL)

Alarm switches offer provisions for immediate audio or visual indication of a tripped breaker due to overload, short-circuit, operation of shunt trip, or undervoltage trip conditions, operation of push button.

They are particularly useful in automated plants where operators must be signaled about changes in the electrical distribution system. This switch features a closed contact when the circuit breaker is tripped automatically. In other words, this switch does not function when the breaker is operated manually. Its contact is open when the circuit breaker is reset.



Auxiliary Switch (AX)

Auxiliary switch is for applications requiring remote “ON” and “OFF” indication. Each switch contains two contacts having a common connection. One is open and the other closed when the circuit breaker is open, and vice-versa.



Undervoltage trip (UVT)

The undervoltage trip automatically opens a circuit breaker when voltage drops to a value ranging between 35% to 70% of the line voltage. The operation is instantaneous, and the circuit breaker cannot be reclosed until the voltage returns to 85% of line voltage.

Continuously energized, the undervoltage trip must be operating before the circuit breaker can be closed.



Shunt Trip (SHT)

The shunt trip opens the mechanism in response to an externally applied voltage signal. LS shunt trips include coil clearing contacts that automatically clear the signal circuit when the mechanism has tripped. contact with live parts and thereby guarantee protection against direct contacts.

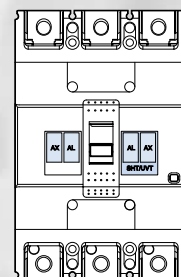
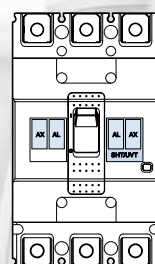
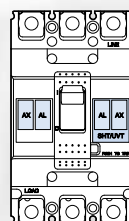

Metasol MCCB/ELCB External accessories

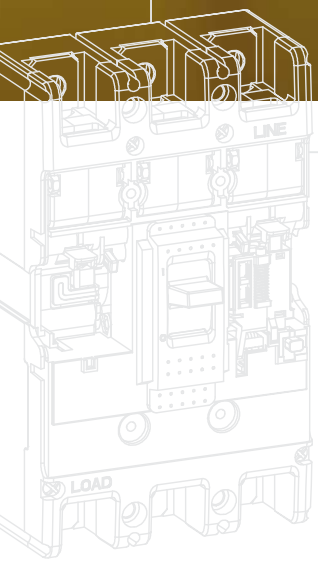

■ External Accessories

Designed for various mount and user safety.



Front and rear connection

Several kinds of terminals can be equipped with ELCBs as well as MCCBs.

- Terminals for front connection
- Rear connection terminals

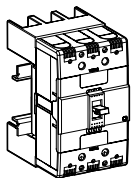

Plug-in base

It makes to extract and/or rapidly replace the circuit breaker without having to touch connections.(Easy replacement and maintenance)

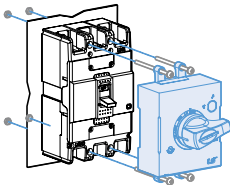

Direct & Extended Rotary Handle

There are two types of rotary handles.

- Direct rotary handle(with or w/o key lock device)
- Extended rotary handle

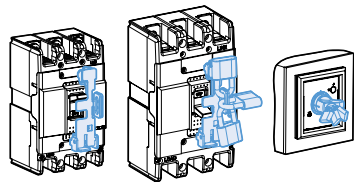

Locking device

- Fixed padlock
- Removable padlock
- Key lock device on direct handle



Insulation barrier

These allow the insulation characteristics between the phases at the connections to be increased.

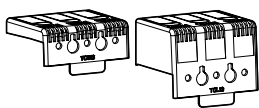

Insulation terminal cover

The terminal covers are applied to the circuit-breaker to prevent accidental contact with live parts and thereby guarantee protection against direct contacts.

Marking and configuration

MCCB

MCCB model

- ABN: Economic type
- ABS: Standard type
- ABH: High capacity type

Standardized characteristics

- Ui: Rated insulation voltage
- Uimp: Impulse withstand voltage
- Ue: Rated operational voltage
- Icu: Ultimate breaking capacity
- Ics: Service breaking capacity



Rated frequency

Utilization category

Manufacturer

Standard

Symbol indicating suitability for isolation as defined by IEC 947-2

MCCB

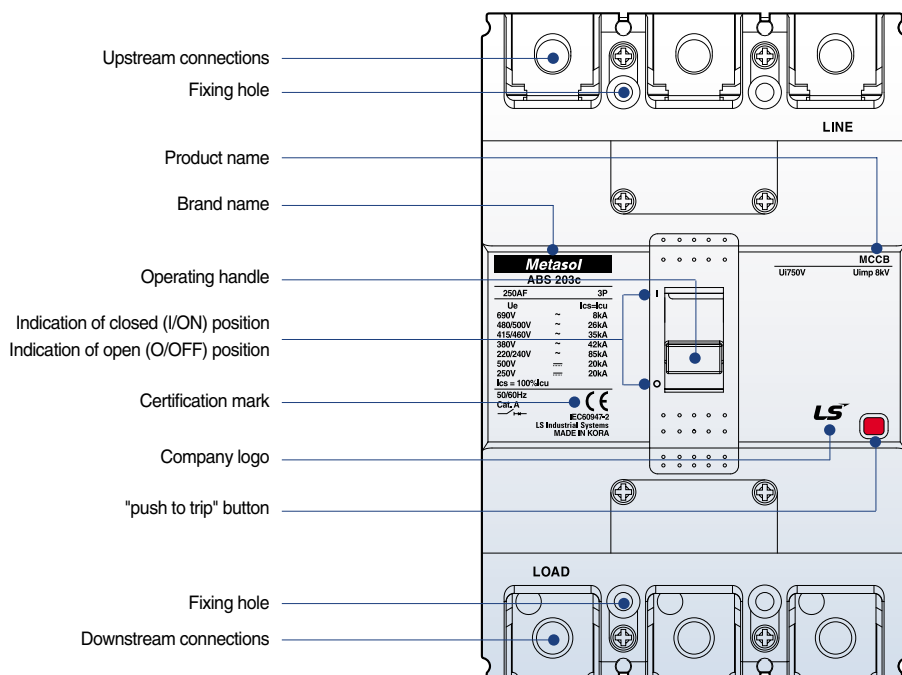

Upstream connections

Fixing hole

Product name

Brand name

Operating handle

Indication of closed (I/ON) position

Indication of open (O/OFF) position

Certification mark

Company logo

"push to trip" button

Fixing hole

Downstream connections

ELCB



- ELCB model**
- EBN: Economic type
 - EBS: Standard type
 - EBH: High capacity type

Rated frequency Standard Manufacturer Utilization category

Symbol indicating suitability for isolation as defined by IEC 947-2

ELCB

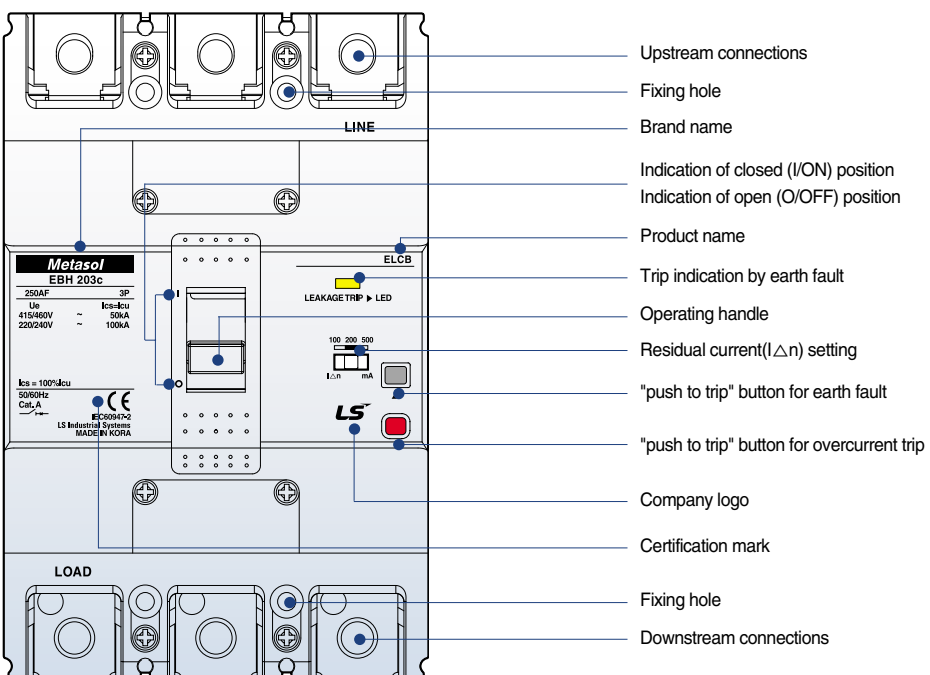

External configuration

MCCB

① Handle

- Function of indications
 - "ON" "OFF" "TRIP"
- Resetting

When the handle indicates "tripped" position it must first be reset by moving the handle to the "OFF" position and then closing is possible
- Trip-Free even if the handle is held at "ON", the breaker will trip if an over current flows
- Suitable for Verification of the main contact position under abnormal conditions because the handle doesn't indicate open position

② Arc-Extinguishing unit

- LS patent technique PASQ
Arc-Extinguishing unit
PASQ : Puffer Assisted Self-Quenching
- Reduction of arc voltage for a short time

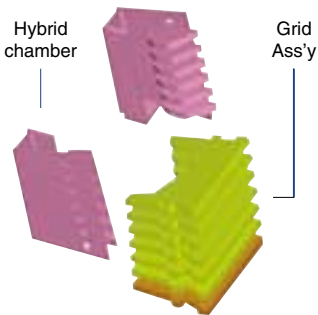

③ Trip button (push to trip)

- Enables tripping mechanically from outside, for confirming the operation of the accessory switches and the manual resetting function.

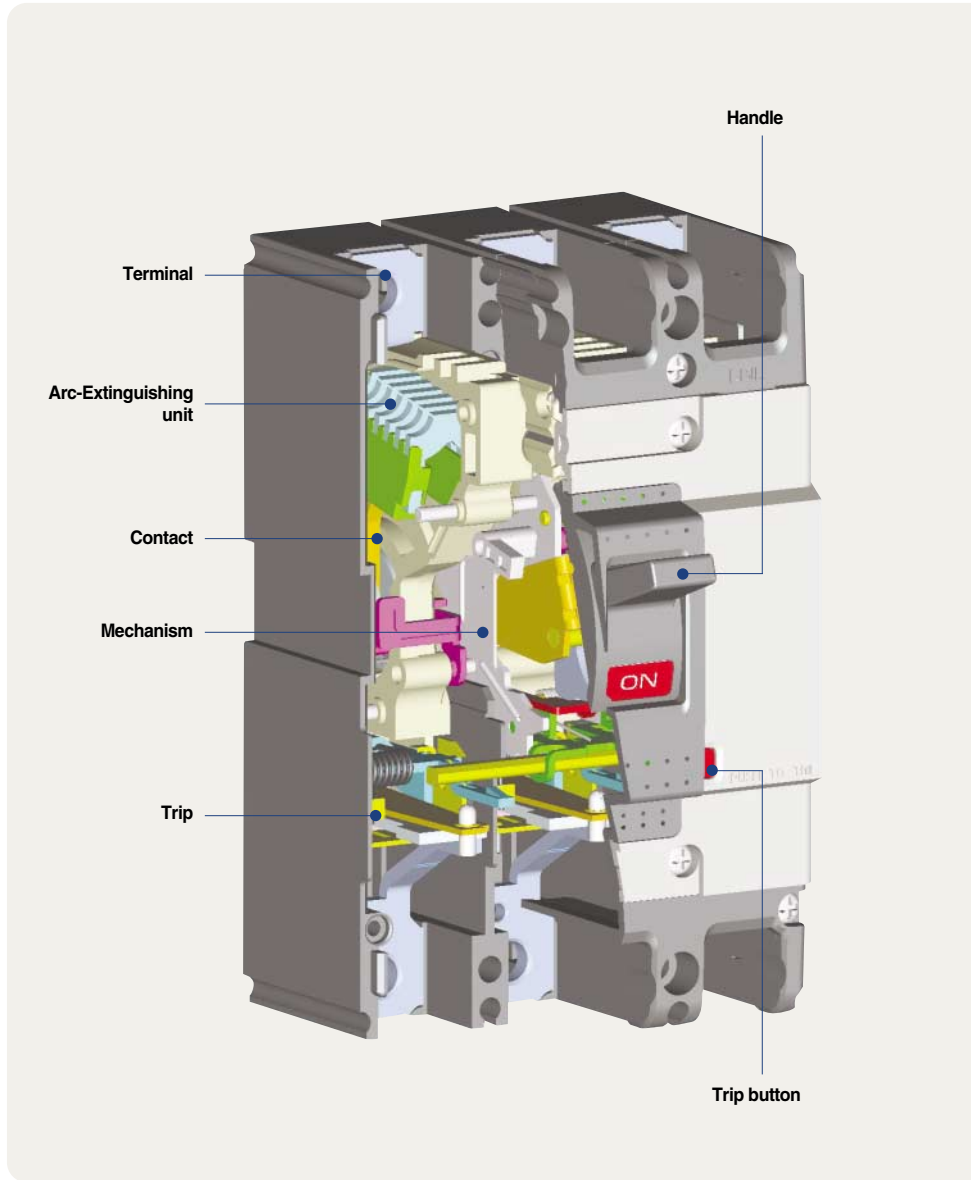

A Application of PASQ Arc Extinguishing

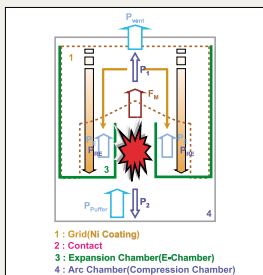

- The reduction of breaking time by applying PASQ arc extinguishing for inhibition of arc voltage for a short time.

A Application of Current limiting structure

- Current limiting repulsion structure (U fixed structure)
- Toggle structure
 - When the operating unit repulses by short circuit current, repulsion structure at bigger angle.



ELCB

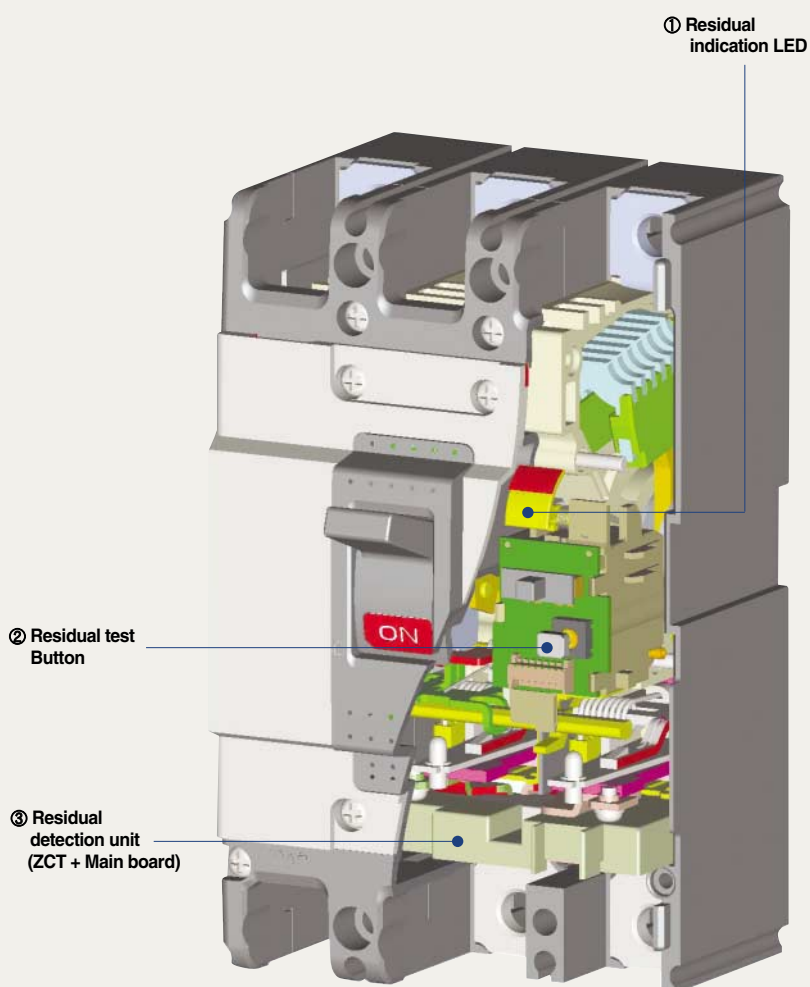

① Residual indication LED

- Normal situation is yellow , trio situation is red

② Residual test Button

- Special design for Upgrade to prohibit resistance accident

③ Residual detection unit (ZCT + Main board)

- For upgrade the design is selected the 3 phase input power method and in case of Voltage problem, it can break residual current safely.

Upgrade coil operation by special design



- Sliding structure application of Trip lever
- Trip special design by applying design Button method.
- Upgrade the testing unit

3 phase power supply method

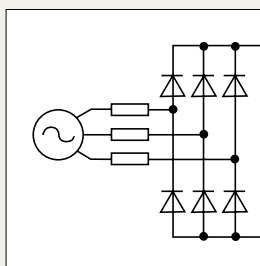

- In case of 1 phase loss residual operation upgrade
- New IEC standard

Quick selection table

Molded Case Circuit Breakers



MCCBs

AF		30AF		50AF			60AF	
Type		E-Type	S-Type	N-Type	S-Type	H-Type	N-Type	S-Type
Type and Pole	2-pole	ABE32b	ABS32c	ABN52c	ABS52c	ABH52c	ABN62c	ABS62c
	3-pole	ABE33b	ABS33c	ABN53c	ABS53c	ABH53c	ABN63c	ABS63c
	4-pole	-	ABS34c	ABN54c	ABS54c	ABH54c	ABN64c	ABS64c
Rated current, I _n	A	(3, 5, 10), 15, 20, 30		15, 20, 30, 40, 50		15, 20, 30, 40, 50	15, 20, 30, 40, 50, 60	
Rated operational voltage, U _e	AC(V)	460	690	690	690	690	690	690
	DC(V)	-	500	500	500	500	500	500
Rated insulation voltage, U _i	V	460	750	750	750	750	750	750
Rated impulse withstand voltage, U _{imp}	kV	6	8	8	8	8	8	8

Rated short-circuit breaking capacity(I_{cu}) kA (Sym), KSC8321, IEC 60947-2

AC	690V	-	2.5	2.5	5	10	2.5	5
	480/500V	-	7.5	7.5	10	35	7.5	10
	415/460V	2.5	14 (10)	14	18	50	14	18
	380V	2.5	18 (14)	18	22	50	18	22
	220/250V	5	30 (25)	30	35	100	30	35
DC	500V(3P)	-	5	5	10	30	5	10
	250V(2P)	-	5	5	10	30	5	10
I _{cs} =% × I _{cu}		50	100	100	100	100	100	100
Dimensions (mm)	W × H × D	75 × 96 × 60mm	75 × 130 × 60mm	75 × 130 × 60mm		90 × 155 × 60mm	75 × 130 × 60mm	
	(3-pole)		(Fig. 1)	(Fig. 1)		(Fig. 2)	(Fig. 1)	
More info.	Ratings	32 page	34 page	36 page		36 page	38 page	
	Curves	87 page	87 page	87 page		88 page	87 page	
	Drawings	92 page	93 page	93 page		94 page	93 page	

Note) The short-circuit breaking capacities in () are applied to the rated current in (3, 5, 10A)

AF Type	30AF	50AF	60AF	100AF	125AF	250AF
ABN		ABN50c 14kA	ABN60c 14kA	ABN100c 18kA		ABN250c 26kA
ABS	ABS30c 14kA	ABS50c 18kA	ABS60c 18kA		ABS125c 37kA	ABS250c 37kA
ABH		ABH50c 50kA			ABH125c 50kA	ABH250c 50kA

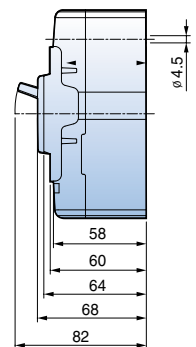
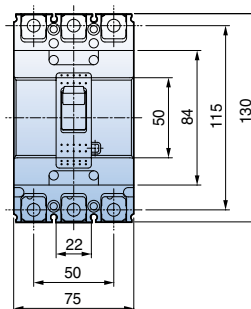

(Fig. 1)



100AF		125AF		250AF		
N-Type	S-Type	H-Type	N-Type	S-Type	H-Type	
ABN102c	ABS102c	ABH102c	ABN202c	ABS202c	ABH202c	
ABN103c	ABS103c	ABH103c	ABN203c	ABS203c	ABH203c	
ABN104c	ABS104c	ABH104c	ABN204c	ABS204c	ABH204c	
15, 20, 30, 40, 50, 60, 75, 100	15, 20, 30, 40, 50, 60, 75, 100, 125		100, 125, 150, 175, 200, 225, 250			
690	690	690	690	690	690	
500	500	500	500	500	500	
750	750	750	750	750	750	
8	8	8	8	8	8	
5	8	10	8	8	10	
10	26	35	18	26	35	
18	37	50	26	37	50	
22	42	50	30	42	50	
35	85	100	65	85	100	
10	20	30	10	20	30	
10	20	30	10	20	30	
100	100	100	100	100	100	
75 × 130 × 60mm (Fig. 1)	90 × 155 × 60mm (Fig. 2)		105 × 165 × 60mm (Fig. 3)			
40 page	42 page		44 page			
87 page	88 page		89 page			
93 page	94 page		95 page			

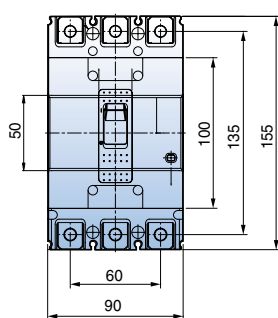

(Fig. 2)

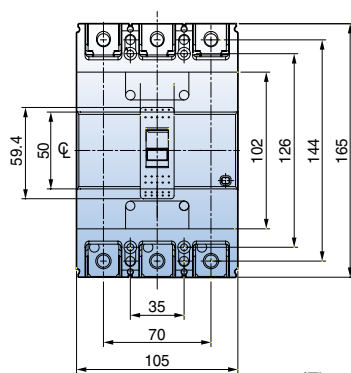
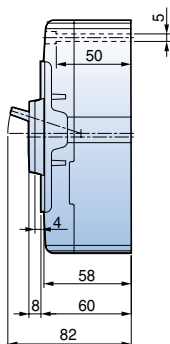

(Fig. 3)

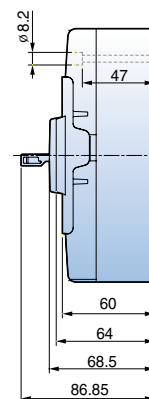

Quick selection table

Molded Case Circuit Breakers



MCCBs

AF		400AF			
Type		N-Type	S-Type	H-Type	L-Type
Type and Pole	2-pole	ABN402c	ABS402c	ABH402c	ABL402c
	3-pole	ABN403c	ABS403c	ABH403c	ABL403c
	4-pole	ABN404c	ABS404c	ABH404c	ABL404c
Rated current, I _n	A	250, 300, 350, 400			
Rated operational voltage, U _e	AC(V)	690	690	690	690
	DC(V)	500	500	500	500
Rated insulation voltage, U _i	V	750	750	750	750
Rated impulse withstand voltage, U _{imp}	kV	8	8	8	8
Rated short-circuit breaking capacity(I_{cu}) kA (Sym), KSC8321, IEC 60947-2					
AC	690V	5	8	10	14
	480/500V	18	35	50	65
	415/460V	37	50	65	85
	380V	42	65	70	100
	220/250V	50	75	85	125
DC	500V(3P)	10	20	40	40
	250V(2P)	10	20	40	40
I _{cs} =% × I _{cu}		100	100	100	75
Dimensions (mm)	W × H × D	140 × 257 × 109mm			
	(3-pole)	(Fig. 4)			
More info.	Ratings	46 page			
	Curves	90 page			
	Drawings	96 page			

Type	AF	400AF	800AF	1000AF	1200AF
ABN		ABN400c 37kA	ABN800c 37kA		
ABS		ABS400c 50kA	ABS800c 65kA	ABS1000b 65kA	ABS1200b 65kA
ABH		ABH400c 65kA			
ABL		ABL400c 85kA	ABL800c 85kA	ABL1000b 85kA	ABL1200b 85kA

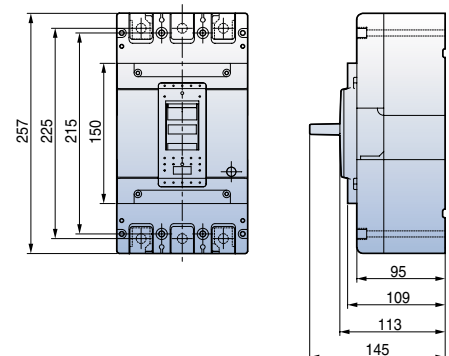

(Fig. 4)



	800 AF			1000 AF		1200 AF		
	N-Type	S-Type	L-Type	S-Type	L-Type	S-Type		L-Type
	ABN802c	ABS802c	ABL802c	-	-	-	-	-
	ABN803c	ABS803c	ABL803c	ABS1003b	ABL1003b	ABS1203b	ABS1203bE	ABL1203b
	ABN804c	ABS804c	ABL804c	ABS1004b	ABL1004b	ABS1204b	-	ABL1204b
	500, 630, 700, 800			1000		1200		
	690	690	690					
	500	500	500					
	750	750	750					
	8	8	8					
	8	10	14					
	25	45	65	50	75	50	50	75
	37	65	85	65	85	65	65	85
	45	75	100	65	85	65	65	85
	50	85	125	100	125	100	100	125
	10	20	40					
	10	20	40					
	100	100	75					
	210 × 280 × 109mm (Fig. 5)			220 × 400 × 105mm (Fig. 6)		220 × 400 × 105mm (Fig. 6)		
	48 page			50 page		50 page	51 page	50 page
	90 page			91 page		91 page	92 page	91 page
	97 page			98 page		98 page	99 page	98 page

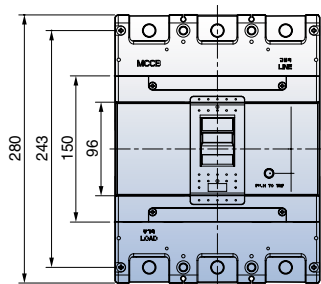

(Fig. 5)

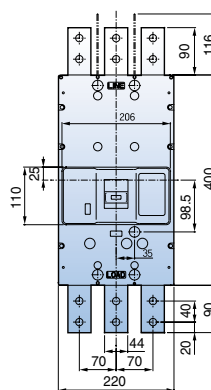
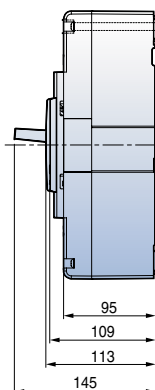

(Fig. 6)

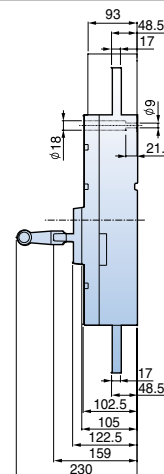

Quick selection table

ZCT Molded Case Circuit Breakers



MCCBs

AF		30AF	50AF			60AF		
Type		S-Type	N-Type	S-Type	H-Type	N-Type	S-Type	
Type and Pole	2-pole	-	-	-	ABH52cZ	-	-	
	3-pole	ABS33cZ	ABN53cZ	ABS53cZ	ABH53cZ	ABN63cZ	ABS63cZ	
	4-pole	ABS34cZ	ABN54cZ	ABS54cZ	ABH54cZ	ABN64cZ	ABS64cZ	
Rated current, I _n	A	15, 20, 30	15, 20, 30, 40, 50			15, 20, 30, 40, 50, 60		
Rated operational voltage, U _e	AC(V)	690	690	690	690	690	690	
Rated insulation voltage, U _i	V	750	750	750	750	750	750	
Rated impulse withstand voltage, U _{imp}	kV	8	8	8	8	8	8	
Rated short-circuit breaking capacity(I_{cu}) kA (Sym), KSC8321, IEC 60947-2								
AC	690V	2.5	2.5	5	10	2.5	5	
	480/500V	7.5	7.5	10	35	7.5	10	
	415/460V	14	14	18	50	14	18	
	380V	18	18	22	50	18	22	
	220/250V	30	30	35	100	30	35	
I _{cs} =% × I _{cu}		100	100	100	100	100	100	
Dimensions (mm)	W × H × D	75 × 130 × 60mm	75 × 130 × 60mm			90 × 155 × 60mm	75 × 130 × 60mm	
	(3-pole)	(Fig. 1)	(Fig. 1)			(Fig. 2)	(Fig. 1)	
More info.	Ratings	32 page	36 page			36 page	38 page	
	Curves	87 page	87 page			88 page	87 page	
	Drawings	92 page	92 page			94 page	92 page	

Note) 1. MCCB와 동일 사양임(Size 동일).
 2. ACCE : MCCB와 동일하게 취급 가능.

AF Type	30AF	50AF	60AF	100AF	125AF	250AF
ABN		ABN50c 14kA	ABN60c 14kA	ABN100c 18kA		ABN250c 26kA
ABS	ABS30c 14kA	ABS50c 18kA	ABS60c 18kA		ABS125c 37kA	ABS250c 37kA
ABH		ABH50c 50kA			ABH125c 50kA	ABH250c 50kA

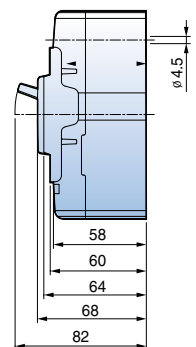
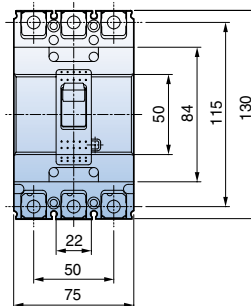

(Fig. 1)



	100AF			125AF			250AF		
	N-Type	S-Type	H-Type	N-Type	S-Type	H-Type	N-Type	S-Type	H-Type
	-	ABS102cZ	ABH102cZ	-	-	-	-	-	-
	ABN103cZ	ABS103cZ	ABH103cZ	ABN203cZ	ABS203cZ	ABH203cZ	ABN204cZ	ABS204cZ	ABH204cZ
	ABN104cZ	ABS104cZ	ABH104cZ	ABN204cZ	ABS204cZ	ABH204cZ			
	15, 20, 30, 40, 50 60, 75, 100, 125	15, 20, 30, 40, 50, 60, 75, 100, 125			100, 125, 150, 175, 200, 225, 250				
	690	690	690	690	690	690	690	690	690
	750	750	750	750	750	750	750	750	750
	8	8	8	8	8	8	8	8	8
	5	8	10	8	8	10	8	8	10
	10	26	35	18	26	35	18	26	35
	18	37	50	26	37	50	26	37	50
	22	42	50	30	42	50	30	42	50
	35	85	100	65	85	100	65	85	100
	100	100	100	100	100	100	100	100	100
	75 × 130 × 60mm (Fig. 1)	90 × 155 × 60mm (Fig. 2)			105 × 165 × 60mm (Fig. 3)				
	40 page	42 page			44 page				
	87 page	88 page			89 page				
	92 page	94 page			95 page				

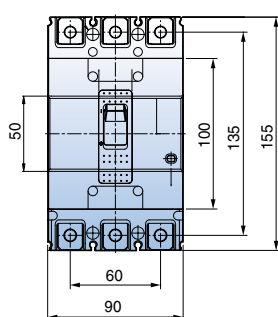

(Fig. 2)

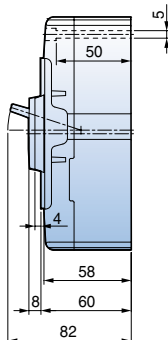

(Fig. 3)

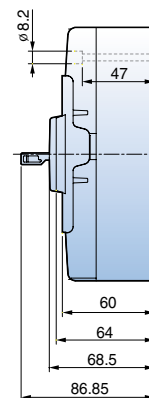
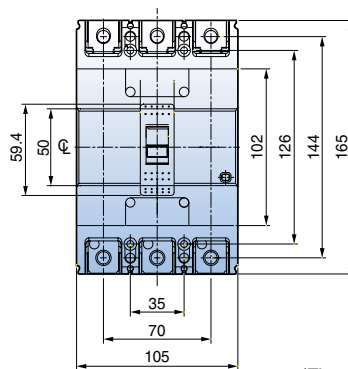

Quick selection table

ZCT Molded Case Circuit Breakers



MCCBs

AF		400AF			
Type		N-Type	S-Type	H-Type	L-Type
Type and Pole	2-pole	-	-		
	3-pole	ABN403cZ	ABS403cZ	ABH403cZ	ABL403cZ
	4-pole	ABN404cZ	ABS404cZ	ABH404cZ	ABL404cZ
Rated current, I _n	A	250, 300, 350, 400			
Rated operational voltage, U _e	AC(V)	690	690	690	690
Rated insulation voltage, U _i	V	750	750	750	750
Rated impulse withstand voltage, U _{imp}	kV	8	8	8	8
Rated short-circuit breaking capacity(I_{cu}) kA (Sym), KSC8321, IEC 60947-2					
AC	690V	5	8	10	14
	480/500V	18	35	50	65
	415/460V	37	50	65	85
	380V	42	65	70	100
	220/250V	50	75	85	125
I _{cs} =% × I _{cu}		100	100	100	75
Dimensions (mm)	W × H × D (3-pole)	140 × 257 × 109mm (Fig. 4)			
More info.	Ratings	46 page			
	Curves	90 page			
	Drawings	96 page			

Note) 1. MCCB와 동일 사양임(Size 동일).
2. ACCE : MCCB와 동일하게 취급 가능.

Type	AF	400AF	800AF
ABN		ABN400c 37kA	ABN800c 37kA
ABS		ABS400c 50kA	ABS800c 65kA
ABH		ABH400c 65kA	
ABL		ABL400c 85kA	ABL800c 85kA



800 AF		
N-Type	S-Type	L-Type
-	-	-
ABN803cZ	ABS803cZ	ABL803cZ
-	-	-
500, 630, 700, 800		
690	690	690
750	750	750
8	8	8
8	10	14
25	45	65
37	65	85
45	75	100
50	85	125
100	100	75
210 × 280 × 109mm		
(Fig. 5)		
48 page		
90 page		
97 page		

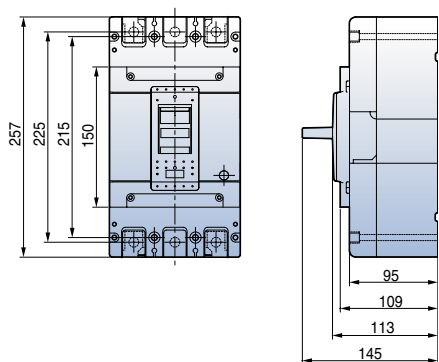

(Fig. 4)

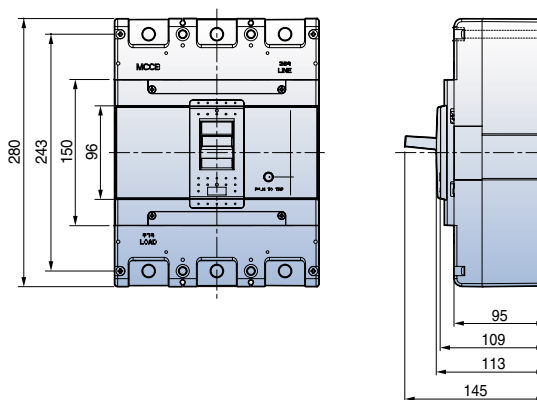

(Fig. 5)

Quick selection table

Earth Leakage Circuit Breakers



ELCBs

AF		30AF	50AF		60AF		
Type		S-Type	N-Type	S-Type	H-Type	N-Type	S-Type
Type and Pole	2-pole	-	EBN52c	-	-	-	-
	3-pole	EBS33c	EBN53c	EBS53c	EBH53c	EBN63c	EBS63c
	4-pole	EBS34c	-	EBS54c	EBH54c	-	EBS64c
Protective function		Overload, Short-circuit and Ground fault		Overload, Short-circuit and Ground fault	Overload, Short-circuit and Ground fault	Overload, Short-circuit and Ground fault	
Rated current, I _n	A	15, 20, 30	15, 20, 30, 40, 50	15, 20, 30, 40, 50	15, 20, 30, 40, 50	60	
Rated residual current, I _{Δn}	mA	30, 100/200/500mA	30, 100/200/500mA	30, 100/200/500mA	30, 100/200/500mA	30, 100/200/500mA	
Rated operational voltage, U _e	AC(V)	220/460		220/460	220/460	220/460	
Rated impulse withstand voltage, U _{imp}	kV	6		6	6	6	
Residual current off-time at I _{Δn}	sec	≤0.1 sec		≤0.1 sec	≤0.1 sec	≤0.1 sec	

Rated short-circuit breaking capacity (I_{cu}) kA (Sym), KSC8321, IEC 60947-2

AC	415/460V	14	14	18	50	14	18
	220/250V	30	30	35	100	30	35
Dimensions (mm)	W × H × D	75 × 130 × 60mm	75 × 130 × 60mm		90 × 155 × 60mm	75 × 130 × 60mm	
	(3-pole)	(Fig. 1)	(Fig. 1)		(Fig. 2)	(Fig. 1)	
More info.	Ratings	54 page	56 page		56 page	58 page	
	Curves	87 page	87 page		88 page	87 page	
	Drawings	100 page	100 page		101 page	100 page	

AF Type	30AF	50AF	60AF	100AF	125AF	250AF
EBN		EBN50c 14kA	EBN60c 14kA	EBN100c 18kA		EBN250c 26kA
EBS	EBS30c 14kA	EBS50c 18kA	EBS60c 18kA		EBS125c 37kA	EBS250c 37kA
EBH		EBH50c 50kA			EBH125c 50kA	EBH250c 50kA

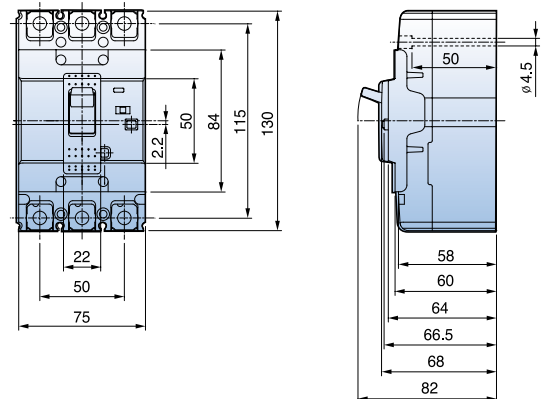

(Fig. 1)



100AF		125AF		250AF		
N-Type	S-Type	H-Type	N-Type	S-Type	H-Type	
EBN102c	-	-	EBN202c	-	-	
EBN103c	EBS103c	EBH103c	EBN203c	EBS203c	EBH203c	
EBN104c	EBS104c	EBH104c	-	EBS204c	EBH204c	
Overload, Short-circuit and Ground fault	Overload, Short-circuit and Ground fault		Overload, Short-circuit and Ground fault			
60, 75, 100	15, 20, 30, 40, 50, 60, 75, 100, 125		100, 125, 150, 175, 200, 225, 250			
30, 100/200/500mA	30, 100/200/500mA		30, 100/200/500mA			
220/460	220/460		220/460			
6	6		6			
≤0.1 sec	≤0.1 sec		≤0.1 sec			
18	37	50	26	37	50	
35	85	100	65	85	100	
75 × 130 × 60mm (Fig. 1)	90 × 155 × 60mm (Fig. 2)		105 × 165 × 60mm (Fig. 3)			
60 page	62 page		64 page			
87 page	88 page		89 page			
100 page	101 page		102 page			

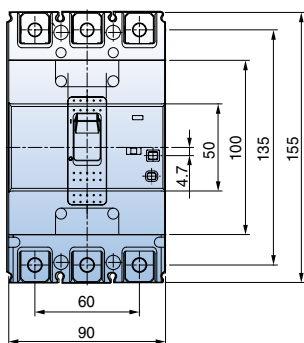

(Fig. 2)

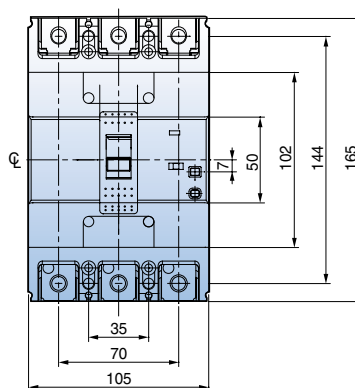
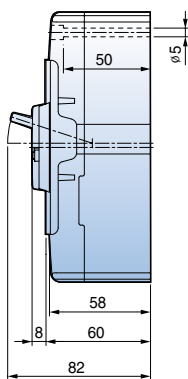

(Fig. 3)

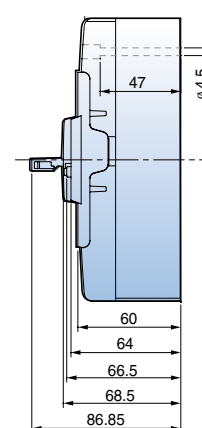

Quick selection table

Earth Leakage Circuit Breakers



ELCBs

AF		400AF			
Type		N-Type	S-Type	H-Type	L-Type
Type and Pole	3-pole	EBN403c	EBS403c	EBH403c	EBL403c
	4-pole	EBN404c	EBS404c	EBH404c	EBL404c
Protective function		Overload, Short-circuit and Ground fault			
Rated current, I _n	A	250, 300, 350, 400			
Rated residual current, I _{Δn}	mA	30, 100/200/500mA			
Rated operational voltage, U _e	AC(V)	220/460	220/460	220/460	220/460
Rated impulse withstand voltage, U _{imp}	kV	6	6	6	6
Residual current off-time at I _{Δn}	sec	0.1 sec	0.1 sec	0.1 sec	0.1 sec
Rated short-circuit breaking capacity (I_{cu}) kA (Sym), KSC8321, IEC 60947-2					
AC	415/460V	37	50	65	85
	220/250V	50	75	85	125
I _{cs} =% × I _{cu}		100	100	100	75
Dimensions (mm)	W × H × D	140 × 257 × 109mm			
	(3-pole)	(Fig. 4)			
More info.	Ratings	66 page			
	Curves	90 page			
	Drawings	103 page			

Type	AF	400AF	800AF	1000AF	1200AF
EBN		EBN400c 37kA	EBN800c 37kA		
EBS		EBS400c 50kA	EBS800c 65kA	EBS1000b 65kA	EBS1200b 65kA
EBH		EBH400c 65kA			
EBL		EBL400c 85kA	EBL800c 85kA		

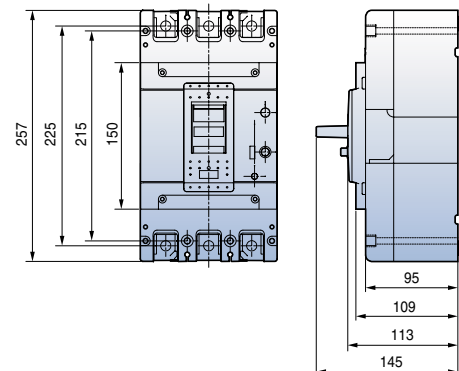

(Fig. 4)



	800 AF			1000 AF	1200 AF
	N-Type	S-Type	L-Type	S-Type	S-Type
	EBN803c	EBS803c	EBL803c	EBS1003b	EBS1203b
	-	-	-	-	-
	Overload, Short-circuit and Ground fault			Overload, Short-circuit and Ground fault	
	500, 630, 700, 800			1000	1200
	30, 100/200/500mA			100/200/500mA	100/200/500mA
	220/460	220/460	220/460	220/460	220/460
	6	6	6		
	0.1 sec	0.1 sec	0.1 sec	0.1 sec	0.1 sec
	37	65	85	85	85
	50	85	125	125	125
	100	100	75		
	210 × 280 × 109mm (Fig. 5)			220 × 565 × 105mm (Fig. 6)	
	68 page			70 page	
	90 page			91 page	
	104 page			105 page	

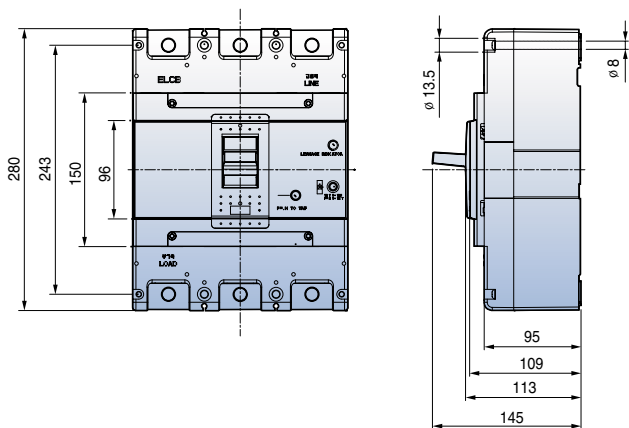

(Fig. 5)

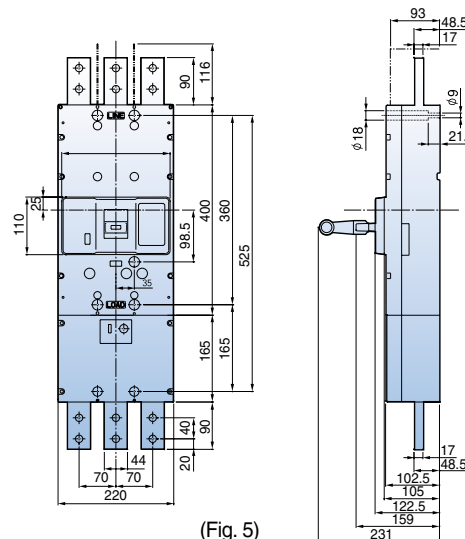

(Fig. 5)

30AF MCCB

ABE30b



ABE32b



ABE33b

Ratings

Frame size		30AF		
Type and Pole		E-Type		
	2-pole	ABE32b		
	3-pole	ABE33b		
	4-pole	-		
Rated current, I _n		3-5-10-15-20-30A		
Rated operational voltage, U _e		AC : 460V		
		-		
Rated insulation voltage, U _i		AC : 460V		
Rated impulse withstand voltage, U _{imp}		6kV		
Rated short-circuit breaking capacity, I_{cu}		E-Type		
	AC 690V	-		
IEC 60947-2 (I _{cu})	480/500V	-		
	460V	2.5kA		
	415V	2.5kA		
	380V	2.5kA		
	220/250V	5kA		
	DC 500V (3P)	-		
	250V (2P)	-		
Protective function		Overload, Short-circuit		
Type of trip unit		Hydraulic-Magnetic		
Magnetic trip range		12I _n		
Endurance	Mechanical	8500 operations		
	Electrical	1500 operations		
Connection	Standard	Front connection		
	Optional	-		
Mounting		Standard Screw fixing		
Dimensions (mm)		Pole	2p	3p
	a		50	75
	b		96	96
	c1 <small>Note)</small>		60	60
	c2 <small>Note)</small>		-	-
	d		80	80
Weight, kg	Standard	0.5	0.7	
Certification		Pole	2p	3p
CE marking			○	○

Note) Depth by door cut size : c1 for large cut, c2 for small cut

For more information

- Drawings ▶ 92 page
- Trip curves ▶ 87 page
- Accessories ▶ 72 page
- Connection and mounting ▶ 100 page

Ordering types

Breaker types

ABE type (2.5kA/460V)		
Rated current, I _n	2-pole	3-pole
3 A	ABE32b/3	ABE33b/3
5 A	ABE32b/5	ABE33b/5
10 A	ABE32b/10	ABE33b/10
15 A	ABE32b/15	ABE33b/15
20 A	ABE32b/20	ABE33b/20
30 A	ABE32b/30	ABE33b/30

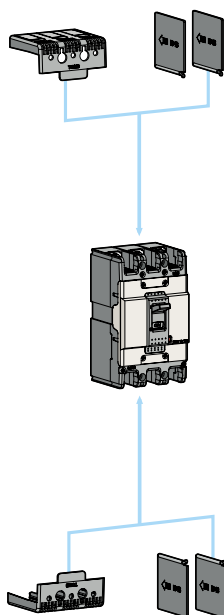

Accessories

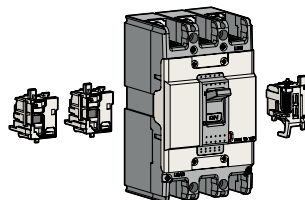

Electrical auxiliaries

AX	Auxiliary Switch
AL	Alarm Switch
SHT	Shunt Trip

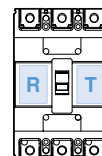

Maximum possibilities

T-position	One of above auxiliaries
R-position	Option of AX or AL

Note) For more detail see 72 page



External accessories

ABE30b	Name
IB13	Insulation barrier
TBS23	Short type

Note) For more detail see 80 page

30AF MCCB

ABS30c



ABS52c



ABS53c



ABS54c

Ratings

Frame size		30AF			
Type and Pole		S-Type			
2-pole		ABS32c			
3-pole		ABS33c			
4-pole		ABS34c			
Rated current, I _n		(3-5-10)-15-20-30A			
Rated operational voltage, U _e		AC: 690V			
		DC: 500V			
Rated insulation voltage, U _i		AC: 750V			
Rated impulse withstand voltage, U _{imp}		8kV			
Rated short-circuit breaking capacity, I_{cu}		S-Type			
AC 690V		2.5 kA			
480/500V		7.5 kA			
IEC 60947-2 (I _{cu}) 460V		14 (10)kA			
415V		14 (10)kA			
380V		18 (14)kA			
220/250V		30 (25)kA			
DC 500V(3P)		5 kA			
250V(2P)		5 kA			
Protective function		Overload, Short-circuit			
Type of trip unit		Thermal-Magnetic			
Magnetic trip range		400A			
Endurance		Mechanical		25000 operations	
		Electrical		10000 operations	
Connection		Standard		Front connection	
		Optional		Rear connection	
				Plug-in	
Mounting		Standard		Screw fixing	
Dimensions (mm)		Pole	2p	3p	4p
		a	50	75	100
		b	130	130	130
		c1 <i>Note)</i>	60	60	60
		c2 <i>Note)</i>	64	64	64
		d	82	82	82
		Weight, kg	Standard	0.5	0.7
Certification		Pole	2p	3p	4p
CE marking			○	○	○

Note) Depth by door cut size : c1 for large cut, c2 for small cut

For more information

- Drawings ▶ 93 page
- Trip curves ▶ 87 page
- Accessories ▶ 72 page
- Connection and mounting ▶ 110 page

Ordering types

Breaker types

ABS type (10kA/460V)			
Rated current, In	2-pole	3-pole	4-pole
3 A	ABS32c/3	ABS33c/3	ABS34c/3
5 A	ABS32c/5	ABS33c/5	ABS34c/5
10 A	ABS32c/10	ABS33c/10	ABS34c/10

ABS type (14kA/460V)			
Rated current, In	2-pole	3-pole	4-pole
15 A	ABS32c/15	ABS33c/15	ABS34c/15
20 A	ABS32c/20	ABS33c/20	ABS34c/20
30 A	ABS32c/30	ABS33c/30	ABS34c/30

Accessories

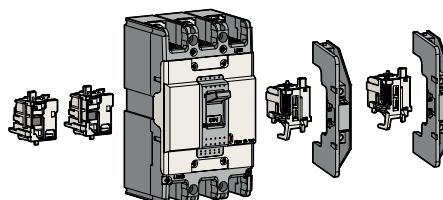

Electrical auxiliaries

AX	Auxiliary Switch	
AL	Alarm Switch	
AX+AL	Combination switch	
SHT	Shunt Trip	
UVT	Undervoltage trip	

Maximum possibilities

T-position	One of above auxiliaries
R-position	Option of AX or AL or AX+AL

Note) For more detail see 72 page

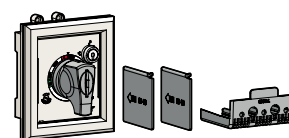
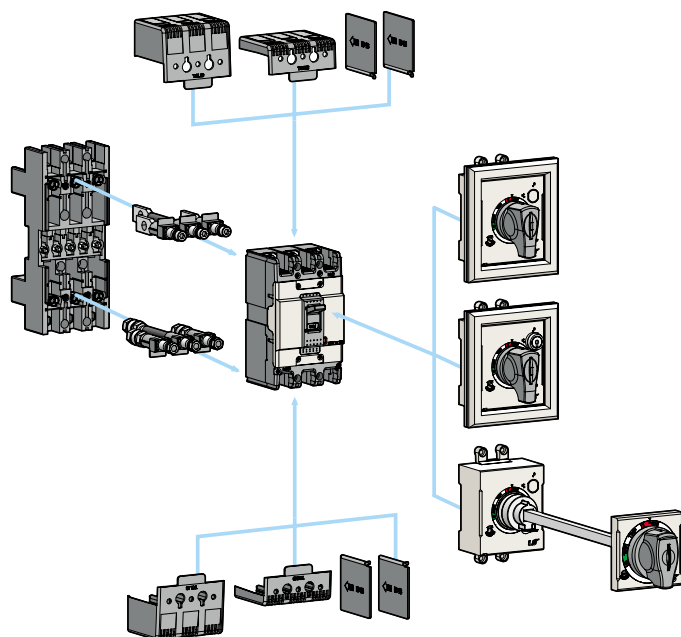

External accessories

ABS30c	Name
IB13	Insulation barrier
TCL13	Terminal cover (Long)
TCS13	Terminal cover (Short)
DH100	Rotary handle (Direct)
DHK100	Rotary handle (Direct, Key lock)
EH100	Rotary handle (Extended)
RTR1	Rear terminal (Round)
PB-A3	Plug-in kit
PHL100C	Pad handle lock

Note) For more detail see 80 page

50AF MCCB

ABN50c, ABS50c, ABH50c



ABS52c



ABS53c



For more information

- Drawings ▶ 93 page
- Trip curves ▶ 87, 88 page
- Accessories ▶ 72 page
- Connection and mounting ▶ 110 page

Ratings

Frame size		50AF													
Type and Pole		N-Type			S-Type			H-Type							
		2-pole		ABN52c			ABS52c			ABH52c					
		3-pole		ABN53c			ABS53c			ABH53c					
		4-pole		ABN54c			ABS54c			ABH54c					
Rated current, I _n		15-20-30-40-50A													
Rated operational voltage, U _e		AC: 690V													
		DC: 500V													
Rated insulation voltage, U _i		AC: 750V													
Rated impulse withstand voltage, U _{imp}		8kV													
Rated short-circuit breaking capacity, I_{cu}		N-Type			S-Type			H-Type							
AC 690V		480/500V		2.5kA			5kA			10kA					
				7.5kA			10kA			35kA					
IEC 60947-2 (I _{cu})				460V			14kA			18kA					
I _{cs} =100%I _{cu}		415V		14kA			18kA			50kA					
		380V		18kA			22kA			50kA					
		220/250V		30kA			35kA			100kA					
DC 500V(3P)				5kA			10kA			30kA					
		250V(2P)		5kA			10kA			30kA					
Protective function		Overload, Short-circuit													
Type of trip unit		Thermal-Magnetic													
Magnetic trip range		12 × I _n (30A and under: 400A)													
Endurance		Mechanical		25000 operations											
		Electrical		10000 operations											
Connection		Standard		Front connection											
		Optional		Rear connection											
		Plug-in													
Mounting		Standard		Screw fixing											
Dimensions (mm)		Pole		2p		3p		4p		2p		3p		4p	
		a		50		75		100		50		75		100	
		b				130				130				155	
		c1 <i>Note)</i>				60				60				60	
		c2 <i>Note)</i>				64				64				64	
		d				82				82				82	
		Weight, kg		Standard		0.5		0.7		0.9		0.5		0.7	
Certification		Pole		2p		3p		4p		2p		3p		4p	
CE marking		CE		○		○		○		○		○		○	

Note) Depth by door cut size : c1 for large cut, c2 for small cut

Ordering types

Breaker types

ABN type (14kA/460V)			
Rated current, In	2-pole	3-pole	4-pole
15 A	ABN52c/15	ABN53c/15	ABN54c/15
20 A	ABN52c/20	ABN53c/20	ABN54c/20
30 A	ABN52c/30	ABN53c/30	ABN54c/30
40 A	ABN52c/40	ABN53c/40	ABN54c/40
50 A	ABN52c/50	ABN53c/50	ABN54c/50

ABS type (18kA/460V)			
Rated current, In	2-pole	3-pole	4-pole
15 A	ABS52c/15	ABS53c/15	ABS54c/15
20 A	ABS52c/20	ABS53c/20	ABS54c/20
30 A	ABS52c/30	ABS53c/30	ABS54c/30
40 A	ABS52c/40	ABS53c/40	ABS54c/40
50 A	ABS52c/50	ABS53c/50	ABS54c/50

ABH type (50kA/460V)			
Rated current, In	2-pole	3-pole	4-pole
15 A	ABH52c/15	ABH53c/15	ABH54c/15
20 A	ABH52c/20	ABH53c/20	ABH54c/20
30 A	ABH52c/30	ABH53c/30	ABH54c/30
40 A	ABH52c/40	ABH53c/40	ABH54c/40
50 A	ABH52c/50	ABH53c/50	ABH54c/50

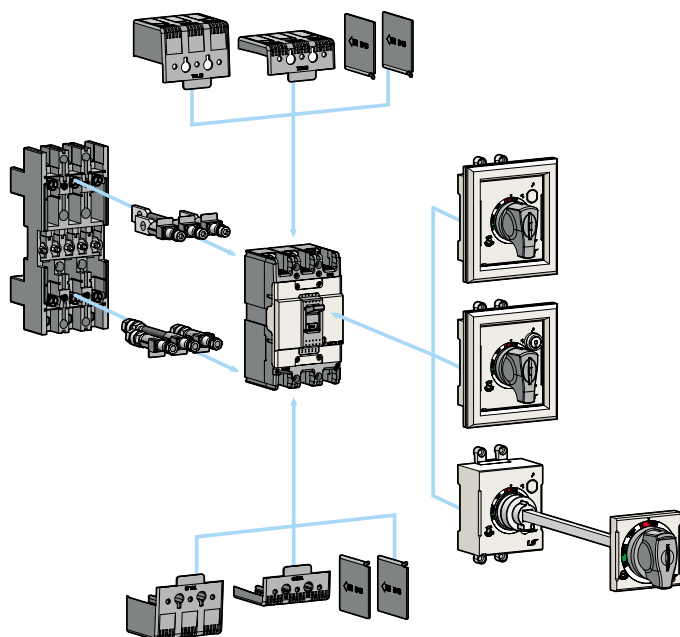

Accessories

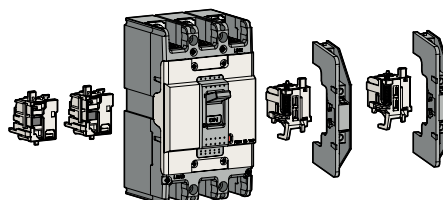

Electrical auxiliaries

AX	Auxiliary Switch	
AL	Alarm Switch	
AX+AL	Combination switch	
SHT	Shunt Trip	
UVT	Undervoltage trip	

Maximum possibilities

T-position	One of above auxiliaries
R-position	Option of AX or AL or AX+AL

Note) For more detail see 72 page

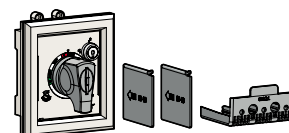

External accessories

ABN50c ABS50c	ABH50c	Name
IB13	IB23	Insulation barrier
TCL13	TCL23	Terminal cover (Long)
TCS13	TCS23	Terminal cover (Short)
DH100	DH125	Rotary handle (Direct)
DHK100	DHK125	Rotary handle (Direct, Key lock)
EH100	EH125	Rotary handle (Extended)
-	RTB2	Rear terminal (Bar)
RTR1	RTR2	Rear terminal (Round)
PB-A3	PB-C3	Plug-in kit
PHL100	PHL125	Pad handle lock

Note) For more detail see 80 page

60AF MCCB

ABN60c, ABS60c



ABS62c



ABS63c



ABS64c

Ratings

Frame size		60AF						
Type and Pole		N-Type			S-Type			
2-pole		ABN62c			ABS62c			
3-pole		ABN63c			ABS63c			
4-pole		ABN64c			ABS64c			
Rated current, I _n		15-20-30-40-50-60A						
Rated operational voltage, U _e		AC: 690V						
		DC: 500V						
Rated insulation voltage, U _i		AC: 750V						
Rated impulse withstand voltage, U _{imp}		8kV						
Rated short-circuit breaking capacity, I_{cu}		N-Type			S-Type			
AC 690V		2.5kA			5kA			
480/500V		7.5kA			10kA			
IEC 60947-2 (I _{cu})		460V			14kA			
I _{cs} =100%I _{cu}		415V			18kA			
		380V			22kA			
		220/250V			35kA			
DC 500V(3P)		5kA			10kA			
250V(2P)		5kA			10kA			
Protective function		Overload, Short-circuit						
Type of trip unit		Thermal-Magnetic						
Magnetic trip range		12 × I _n (30A and under: 400A)						
Endurance		Mechanical		25000 operations				
		Electrical		10000 operations				
Connection		Standard		Front connection				
		Optional		Rear connection				
				Plug-in				
Mounting		Standard		Screw fixing				
Dimensions (mm)		Pole	2p	3p	4p	2p	3p	4p
		a	50	75	100	50	75	100
		b	130			130		
		c1 <small>Note)</small>	60			60		
		c2 <small>Note)</small>	64			64		
		d	82			82		
		Weight, kg	Standard	0.5	0.7	0.9	0.5	0.7
Certification		Pole	2p	3p	4p	2p	3p	4p
CE marking		☑		○		○		

Note) Depth by door cut size : c1 for large cut, c2 for small cut

For more information

- Drawings ▶ 93 page
- Trip curves ▶ 87 page
- Accessories ▶ 72 page
- Connection and mounting ▶ 110 page

Ordering types

Breaker types

ABN type (14kA/460V)			
Rated current, In	2-pole	3-pole	4-pole
15 A	ABN62c/15	ABN63c/15	ABN64c/15
20 A	ABN62c/20	ABN63c/20	ABN64c/20
30 A	ABN62c/30	ABN63c/30	ABN64c/30
40 A	ABN62c/40	ABN63c/40	ABN64c/40
50 A	ABN62c/50	ABN63c/50	ABN64c/50
60 A	ABN62c/60	ABN63c/60	ABN64c/60

ABS type (18kA/460V)			
Rated current, In	2-pole	3-pole	4-pole
15 A	ABS62c/15	ABS63c/15	ABS64c/15
20 A	ABS62c/20	ABS63c/20	ABS64c/20
30 A	ABS62c/30	ABS63c/30	ABS64c/30
40 A	ABS62c/40	ABS63c/40	ABS64c/40
50 A	ABS62c/50	ABS63c/50	ABS64c/50
60 A	ABS62c/60	ABS63c/60	ABS64c/60

Accessories

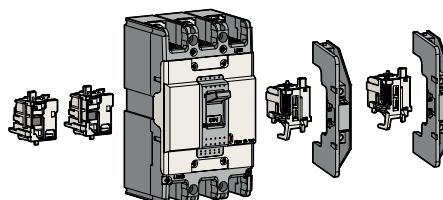

Electrical auxiliaries

AX	Auxiliary Switch	
AL	Alarm Switch	
AX+AL	Combination switch	
SHT	Shunt Trip	
UVT	Undervoltage trip	

Maximum possibilities

T-position	One of above auxiliaries
R-position	Option of AX or AL or AX+AL

Note) For more detail see 72 page

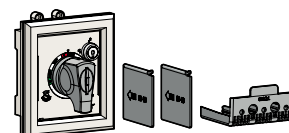
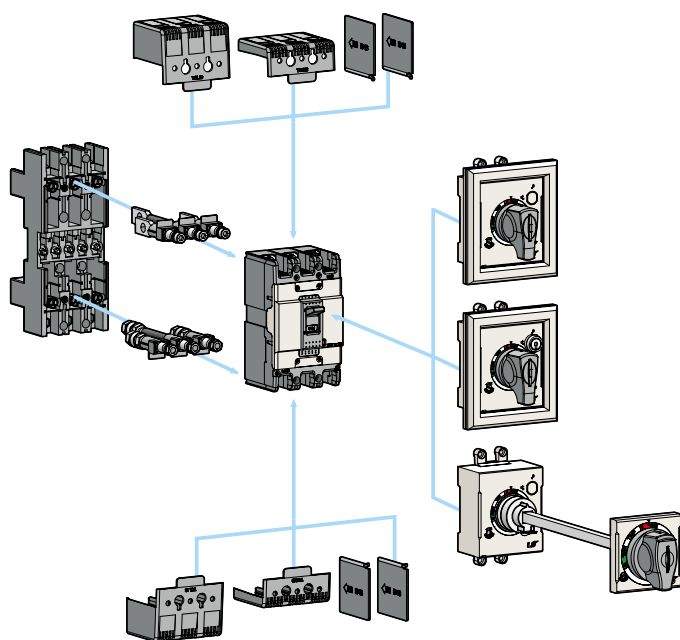

External accessories

ABS60c ABN60c	Name
IB13	Insulation barrier
TCL13	Terminal cover (Long)
TCS13	Terminal cover (Short)
DH100	Rotary handle (Direct)
DHK100	Rotary handle (Direct, Key lock)
EH100	Rotary handle (Extended)
RTB1	Rear terminal (Bar)
RTR1	Rear terminal (Round)
PB-A3	Plug-in kit
PHL100	Pad handle lock

Note) For more detail see 80 page

100AF MCCB

ABN100c

Metasol



ABN102c



ABN103c



ABN104c

For more information

- Drawings ▶ 93 page
- Trip curves ▶ 87 page
- Accessories ▶ 72 page
- Connection and mounting ▶ 110 page

Ratings

Frame size		100AF			
Type and Pole		N-Type			
2-pole		ABN102c			
3-pole		ABN103c			
4-pole		ABN104c			
Rated current, I _n		15-20-30-40-50-60-75-100A			
Rated operational voltage, U _e		AC: 690V			
		DC: 500V			
Rated insulation voltage, U _i		AC: 750V			
Rated impulse withstand voltage, U _{imp}		8kV			
Rated short-circuit breaking capacity, I_{cu}		N-Type			
AC 690V		5kA			
480/500V		10kA			
IEC 60947-2 (I _{cu})		460V		18kA	
I _{cs} =100%I _{cu}		415V		18kA	
		380V		22kA	
		220/250V		35kA	
DC 500V(3P)		10kA			
250V(2P)		10kA			
Protective function		Overload, Short-circuit			
Type of trip unit		Thermal-Magnetic			
Magnetic trip range		400A			
Endurance		Mechanical		25000 operations	
		Electrical		10000 operations	
Connection		Standard		Front connection	
		Optional		Rear connection	
				Plug-in	
Mounting		Standard		Screw fixing	
Dimensions (mm)		Pole	2p	3p	4p
		a	50	75	100
		b	130	130	130
		c1 <i>Note)</i>	60	60	60
		c2 <i>Note)</i>	64	64	64
		d	82	82	82
		Weight, kg	Standard	0.5	0.7
Certification		Pole	2p	3p	4p
CE marking			○	○	○

Note) Depth by door cut size : c1 for large cut, c2 for small cut

Ordering types

Breaker types

ABN type (14kA/460V)			
Rated current, I _n	2-pole	3-pole	4-pole
15 A	ABN102c/15	ABN103c/15	ABN104c/15
20 A	ABN102c/20	ABN103c/20	ABN104c/20
30 A	ABN102c/30	ABN103c/30	ABN104c/30
40 A	ABN102c/40	ABN103c/40	ABN104c/40
50 A	ABN102c/50	ABN103c/50	ABN104c/50
60 A	ABN102c/60	ABN103c/60	ABN104c/60
75 A	ABN102c/75	ABN103c/75	ABN104c/75
100 A	ABN102c/100	ABN103c/100	ABN104c/100

Accessories

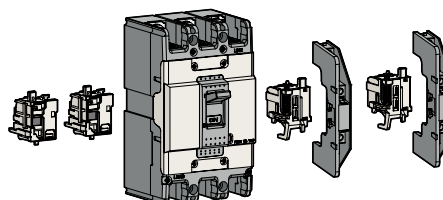

Electrical auxiliaries

AX	Auxiliary Switch	
AL	Alarm Switch	
AX+AL	Combination switch	
SHT	Shunt Trip	
UVT	Undervoltage trip	

Maximum possibilities

T-position	One of above auxiliaries
R-position	Option of AX or AL or AX+AL

Note) For more detail see 72 page

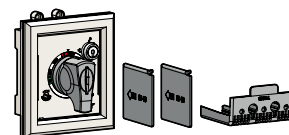
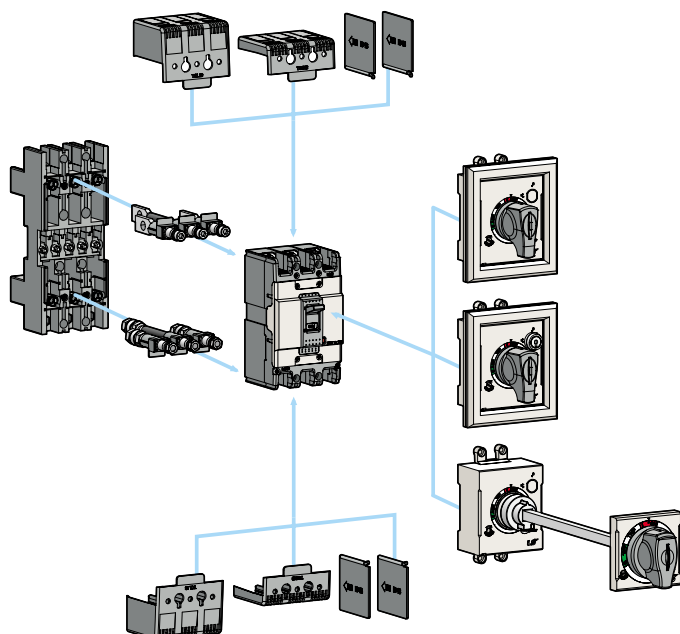

External accessories

ABN100c	Name
IB13	Insulation barrier
TCL13	Terminal cover (Long)
TCS13	Terminal cover (Short)
DH100	Rotary handle (Direct)
DHK100	Rotary handle (Direct, Key lock)
EH100	Rotary handle (Extended)
RTB1	Rear terminal (Bar)
RTR1	Rear terminal (Round)
PB-A3	Plug-in kit
PHL100	Pad handle lock

Note) For more detail see 80 page

125AF MCCB

ABS125c, ABH125c



ABS102c



ABS103c



ABS104c

For more information

- Drawings ▶ 94 page
- Trip curves ▶ 88 page
- Accessories ▶ 72 page
- Connection and mounting ▶ 110 page

Ratings

Frame size		125AF						
Type and Pole		S-Type			H-Type			
	2-pole	ABS102c			ABH102c			
	3-pole	ABS103c			ABH103c			
	4-pole	ABS104c			ABH104c			
Rated current, I _n		15-20-30-40-50-60-75-100-125A						
Rated operational voltage, U _e		AC: 690V						
		DC: 500V						
Rated insulation voltage, U _i		AC: 750V						
Rated impulse withstand voltage, U _{imp}		8kV						
Rated short-circuit breaking capacity, I_{cu}		S-Type			H-Type			
AC	690V	8kA			10kA			
	480/500V	26kA			35kA			
IEC 60947-2 (I _{cu})		460V			37kA			
I _{cs} =100%I _{cu}	415V	37kA			50kA			
	380V	42kA			50kA			
	220/250V	85kA			100kA			
DC	500V(3P)	20kA			30kA			
	250V(2P)	20kA			30kA			
Protective function		Overload, Short-circuit						
Type of trip unit		Thermal-Magnetic						
Magnetic trip range		12 × I _n (30A and under: 400A)						
Endurance	Mechanical	25000 operations						
	Electrical	10000 operations						
Connection	Standard	Front connection						
	Optional	Rear connection						
Mounting		Screw fixing						
Dimensions (mm)		Pole	2p	3p	4p	2p	3p	4p
		a	60	90	120	60	90	120
		b	155			155		
		c1 <i>Note)</i>	60			60		
		c2 <i>Note)</i>	64			64		
		d	82			82		
		Weight, kg	Standard	0.7	1	1.2	0.7	1
Certification		Pole	2p	3p	4p	2p	3p	4p
CE marking		CE	○			○		

Note) Depth by door cut size : c1 for large cut, c2 for small cut

Ordering types

Breaker types

ABS type (37kA/460V)			
Rated current, In	2-pole	3-pole	4-pole
15 A	ABS102c/15	ABS103c/15	ABS104c/15
20 A	ABS102c/20	ABS103c/20	ABS104c/20
30 A	ABS102c/30	ABS103c/30	ABS104c/30
40 A	ABS102c/40	ABS103c/40	ABS104c/40
50 A	ABS102c/50	ABS103c/50	ABS104c/50
60 A	ABS102c/60	ABS103c/60	ABS104c/60
75 A	ABS102c/75	ABS103c/75	ABS104c/75
100 A	ABS102c/100	ABS103c/100	ABS104c/100
125 A	ABS102c/125	ABS103c/125	ABS104c/125

ABH type (50kA/460V)			
Rated current, In	2-pole	3-pole	4-pole
15 A	ABH102c/15	ABH103c/15	ABH104c/15
20 A	ABH102c/20	ABH103c/20	ABH104c/20
30 A	ABH102c/30	ABH103c/30	ABH104c/30
40 A	ABH102c/40	ABH103c/40	ABH104c/40
50 A	ABH102c/50	ABH103c/50	ABH104c/50
60 A	ABH102c/60	ABH103c/60	ABH104c/60
75 A	ABH102c/75	ABH103c/75	ABH104c/75
100 A	ABH102c/100	ABH103c/100	ABH104c/100
125 A	ABH102c/125	ABH103c/125	ABH104c/125

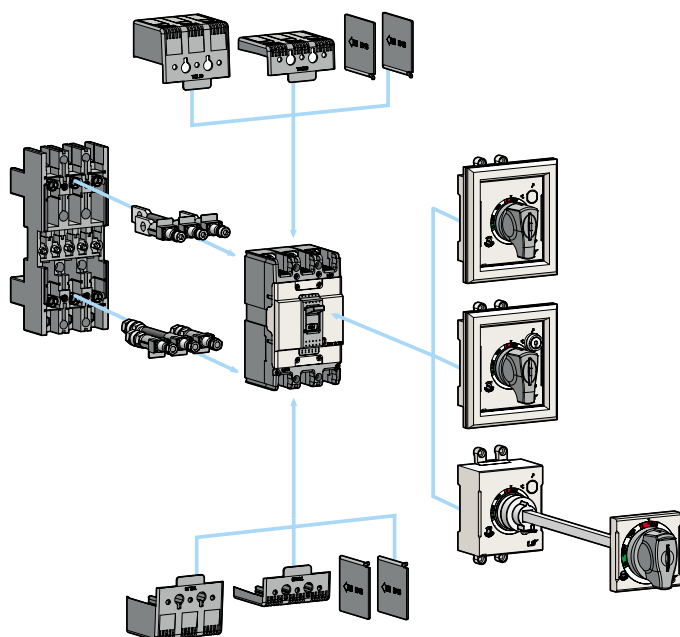

Accessories

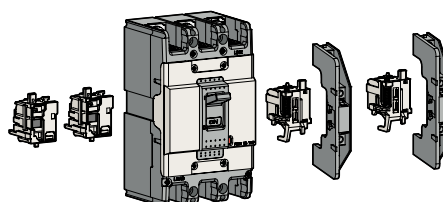

Electrical auxiliaries

AX	Auxiliary Switch	
AL	Alarm Switch	
AX+AL	Combination switch	
SHT	Shunt Trip	
UVT	Undervoltage trip	

Maximum possibilities

T-position	One of above auxiliaries
R-position	Option of AX or AL or AX+AL

Note) For more detail see 72 page

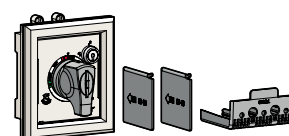

External accessories

ABS125c ABH125c	Name
IB23	Insulation barrier
TCL23	Terminal cover (Long)
TCS23	Terminal cover (Short)
DH125	Rotary handle (Direct)
DHK125	Rotary handle (Direct, Key lock)
EH125	Rotary handle (Extended)
RTB2	Rear terminal (Bar)
RTR2	Rear terminal (Round)
PB-C3	Plug-in kit
PHL125	Pad handle lock

Note) For more detail see 80 page

250AF MCCB

ABN250c, ABS250c, ABH250c



ABS202c



ABS203c



ABS204c

Ratings

Frame size		250AF										
Type and Pole		N-Type			S-Type			H-Type				
2-pole		ABN202c			ABS202c			ABH202c				
3-pole		ABN203c			ABS203c			ABH203c				
4-pole		ABN204c			ABS204c			ABH204c				
Rated current, In		100-125-150-175-200-225-250A										
Rated operational voltage, Ue		AC: 690V DC: 500V										
Rated insulation voltage, Ui		AC: 750V										
Rated impulse withstand voltage, Uimp		8kV										
Rated short-circuit breaking capacity, Icu		N-Type			S-Type			H-Type				
AC 690V		8kA			8kA			10kA				
480/500V		18kA			26kA			35kA				
IEC 60947-2 (Icu)		460V			26kA			37kA				
IEC 60947-2 (Icu)		460V			26kA			37kA				
IEC 60947-2 (Icu)		415V			26kA			37kA				
IEC 60947-2 (Icu)		380V			30kA			42kA				
IEC 60947-2 (Icu)		220/250V			65kA			85kA				
DC 500V(3P)		10kA			20kA			30kA				
DC 250V(2P)		10kA			20kA			30kA				
Protective function		Overload, Short-circuit										
Type of trip unit		Thermal-Magnetic										
Magnetic trip range		12 × In										
Endurance		Mechanical			25000 operations							
Endurance		Electrical			10000 operations							
Connection		Standard			Front connection							
Connection		Optional			Rear connection							
Connection					Plug-in							
Mounting		Standard			Screw fixing							
Dimensions (mm)		Pole		2p	3p	4p	2p	3p	4p	2p	3p	4p
a				105	105	140	105	105	140	105	105	140
b					165			165			165	
c1 <small>Note)</small>					60			60			60	
c2 <small>Note)</small>					64			64			64	
d					87			87			87	
Weight, kg		Standard		1.1	1.2	1.6	1.1	1.2	1.6	1.1	1.2	1.6
Certification		Pole		2p	3p	4p	2p	3p	4p	2p	3p	4p
CE marking		CE			○			○			○	

Note) Depth by door cut size : c1 for large cut, c2 for small cut

For more information

- Drawings ▶ 95 page
- Trip curves ▶ 89 page
- Accessories ▶ 72 page
- Connection and mounting ▶ 110 page

Ordering types

Breaker types

ABN type (25kA/460V)			
Rated current, In	2-pole	3-pole	4-pole
100 A	ABN202c/100	ABN203c/100	ABN204c/100
125 A	ABN202c/125	ABN203c/125	ABN204c/125
150 A	ABN202c/150	ABN203c/150	ABN204c/150
175 A	ABN202c/175	ABN203c/175	ABN204c/175
200 A	ABN202c/200	ABN203c/200	ABN204c/200
225 A	ABN202c/225	ABN203c/225	ABN204c/225
250 A	ABN202c/250	ABN203c/250	ABN204c/250

ABS type (37kA/460V)			
Rated current, In	2-pole	3-pole	4-pole
100 A	ABS202c/100	ABS203c/100	ABS204c/100
125 A	ABS202c/125	ABS203c/125	ABS204c/125
150 A	ABS202c/150	ABS203c/150	ABS204c/150
175 A	ABS202c/175	ABS203c/175	ABS204c/175
200 A	ABS202c/200	ABS203c/200	ABS204c/200
225 A	ABS202c/225	ABS203c/225	ABS204c/225
250 A	ABS202c/250	ABS203c/250	ABS204c/250

ABH type (50kA/460V)			
Rated current, In	2-pole	3-pole	4-pole
100 A	ABH202c/100	ABH203c/100	ABH204c/100
125 A	ABH202c/125	ABH203c/125	ABH204c/125
150 A	ABH202c/150	ABH203c/150	ABH204c/150
175 A	ABH202c/175	ABH203c/175	ABH204c/175
200 A	ABH202c/200	ABH203c/200	ABH204c/200
225 A	ABH202c/225	ABH203c/225	ABH204c/225
250 A	ABH202c/250	ABH203c/250	ABH204c/250

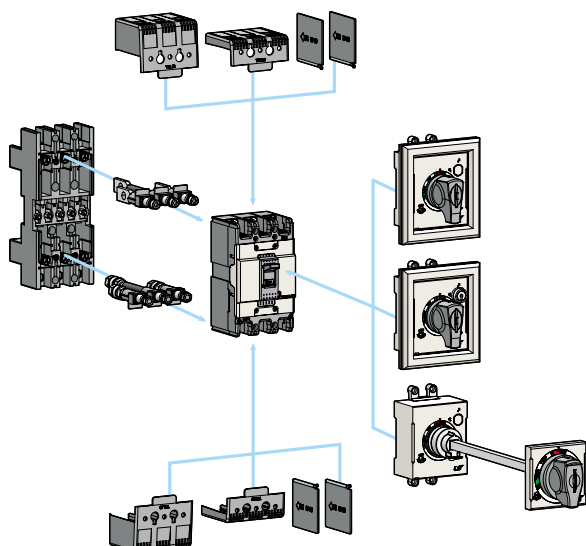

Accessories

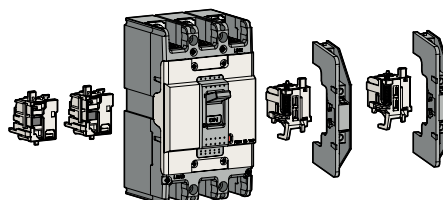

Electrical auxiliaries

AX	Auxiliary Switch	
AL	Alarm Switch	
AX+AL	Combination switch	
SHT	Shunt Trip	
UVT	Undervoltage trip	

Maximum possibilities

T-position	One of above auxiliaries
R-position	Option of AX or AL or AX+AL

Note) For more detail see 72 page

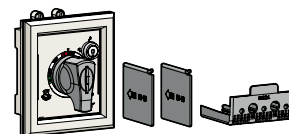

External accessories

ABH250c	Name
B33	Insulation barrier
TCL33	Terminal cover (Long)
TCS33	Terminal cover (Short)
DH250	Rotary handle (Direct)
DHK250	Rotary handle (Direct, Key lock)
EH250	Rotary handle (Extended)
RTB3	Rear terminal (Bar)
RTR3	Rear terminal (Round)
PBA250C	Plug-in kit
PHL250	Pad handle lock

Note) For more detail see 80 page

400AF MCCB

ABN400c, ABS400c, ABH400c, ABL400c



ABS403c



ABL404c

Ratings

Frame size		400AF												
Type and Pole		N-Type			S-Type			H-Type			L-Type			
	2-pole	ABN402c			ABS402c			ABH402c			ABL402c			
	3-pole	ABN403c			ABS403c			ABH403c			ABL403c			
	4-pole	ABN404c			ABS404c			ABH404c			ABL404c			
Rated current, I _n		250-300-350-400A												
Rated operational voltage, U _e		AC: 690V												
		DC: 500V												
Rated insulation voltage, U _i		AC: 750V												
Rated impulse withstand voltage, U _{imp}		8kV												
Rated short-circuit breaking capacity, I_{cu}		N-Type			S-Type			H-Type			L-Type			
AC	690V	5kA			8kA			10kA			14kA			
	480/500V	18kA			35kA			50kA			65kA			
IEC 60947-2 (I _{cu})	415/460V	37kA			50kA			65kA			85kA			
	380V	42kA			65kA			70kA			100kA			
DC	500V(3P)	10kA			20kA			40kA			40kA			
	250V(3P)	10kA			20kA			40kA			40kA			
I _{cs} =100%I _{cu}	125V	100%			100%			100%			75%			
Protective function		Overload, Short-circuit												
Type of trip unit		Thermal-Magnetic												
Magnetic trip range		8~12I _n												
Endurance	Mechanical	4000 operations												
	Electrical	1000 operations												
Connection	Standard	Front connection												
	Optional	Rear connection												
		Plug-in												
Mounting		Standard												
		Screw fixing												
Dimensions (mm)		Pole	2p	3p	4p	2p	3p	4p	2p	3p	4p	2p	3p	4p
		a	140	140	184	140	140	184	140	140	184	140	140	184
		b	257			257			257			257		
		c1 <i>Note)</i>	109			109			109			109		
		c2 <i>Note)</i>	113			113			113			113		
		d	145			145			145			145		
		Weight, kg	Standard	5.2	6.2	7.8	5.2	6.2	7.8	5.2	6.2	7.8	5.2	6.2
Certification		Pole	2p	3p	4p	2p	3p	4p	2p	3p	4p	2p	3p	4p
CE marking		CE	○			○			○			○		

Note) Depth by door cut size : c1 for large cut, c2 for small cut

For more information

- Drawings ▶ 96 page
- Trip curves ▶ 90 page
- Accessories ▶ 72 page
- Connection and mounting ▶ 111 page

Ordering types

Breaker types

ABN type (37kA/460V)			
Rated current, In	2-pole	3-pole	4-pole
250 A	ABN402c/250	ABN403c/250	ABN404c/250
300 A	ABN402c/300	ABN403c/300	ABN404c/300
350 A	ABN402c/350	ABN403c/350	ABN404c/350
400 A	ABN402c/400	ABN403c/400	ABN404c/400

ABS type (50kA/460V)			
Rated current, In	2-pole	3-pole	4-pole
250 A	ABS402c/250	ABS403c/250	ABS404c/250
300 A	ABS402c/300	ABS403c/300	ABS404c/300
350 A	ABS402c/350	ABS403c/350	ABS404c/350
400 A	ABS402c/400	ABS403c/400	ABS404c/400

ABH type(65kA/460V)			
Rated current, In	2-pole	3-pole	4-pole
250 A	ABH402c/250	ABH403c/250	ABH404c/250
300 A	ABH402c/300	ABH403c/300	ABH404c/300
350 A	ABH402c/350	ABH403c/350	ABH404c/350
400 A	ABH402c/400	ABH403c/400	ABH404c/400

ABL type(85kA/460V)			
Rated current, In	2-pole	3-pole	4-pole
250 A	ABL402c/250	ABL403c/250	ABL404c/250
300 A	ABL402c/300	ABL403c/300	ABL404c/300
350 A	ABL402c/350	ABL403c/350	ABL404c/350
400 A	ABL402c/400	ABL403c/400	ABL404c/400

Accessories

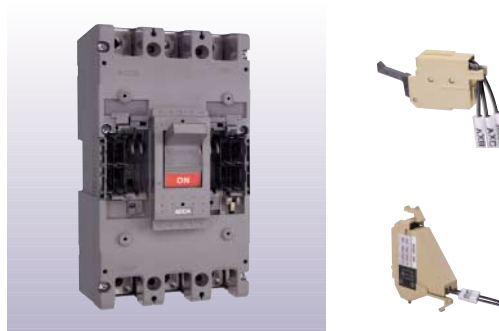

Electrical auxiliaries

AX	Auxiliary Switch	
AL	Alarm Switch	
SHT	Shunt Trip	
UVT	Undervoltage trip	

Maximum possibilities

T-position	Option of 2AX, 2AL and SHT or UVT
R-position	Option of 2AX, 2AL and SHT or UVT

Note) For more detail see 73 page

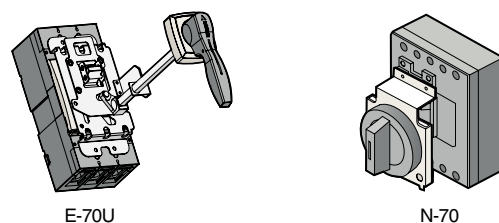

External accessories

IBL400	Insulation barrier
T1-43A	Terminal cover (Long) - 2, 3pole
T1-44A	Terminal cover (Long) - 4pole
N-70	Rotary handle (Direct)
E-70U	Rotary handle (Extended)
MI-43	Mechanical interlock - 2, 3pole
MI-44	Mechanical interlock - 4pole
X-402	Rear terminal - 2pole
X-403	Rear terminal - 3pole
X-404	Rear terminal - 4pole
PB-I3-FR	Plug-in kit

Note) For more detail see 80 page

800AF MCCB

ABN800c, ABS800c, ABL800c



ABS803c



ABL804c

Ratings

Frame size		800AF											
Type and Pole		N-Type			S-Type			L-Type					
2-pole		ABN802c			ABS802c			ABL802c					
3-pole		ABN803c			ABS803c			ABL803c					
4-pole		ABN804c			ABS804c			ABL804c					
Rated current, I _n		500-630-700-800A											
Rated operational voltage, U _e		AC: 690V											
		DC: 500V											
Rated insulation voltage, U _i		AC: 750V											
Rated impulse withstand voltage, U _{imp}		8kV											
Rated short-circuit breaking capacity, I_{cu}		N-Type			S-Type			L-Type					
AC 690V		8kA			10kA			14kA					
480/500V		25kA			45kA			65kA					
IEC 60947-2 (I _{cu})		415/460V			37kA			65kA					
380V		45kA			75kA			100kA					
220/250V		50kA			85kA			125kA					
DC 500V(3P)		10kA			20kA			40kA					
250V(3P)		10kA			20kA			40kA					
I _{cs} =100%I _{cu}		125V			100%			100%					
75%													
Protective function		Overload, Short-circuit											
Type of trip unit		Thermal-Magnetic											
Magnetic trip range		8~12I _n											
Endurance		Mechanical			2500 operations								
		Electrical			500 operations								
Connection		Standard			Front connection								
		Optional			Rear connection								
					Plug-in								
Mounting		Standard			Screw fixing								
Dimensions (mm)		Pole		2p	3p	4p	2p	3p	4p	2p	3p	4p	
		a		210	210	280	210	210	280	210	210	280	
		b			280		280		280		280		280
		c1 <i>Note)</i>			109		109		109		109		109
		c2 <i>Note)</i>			113		113		113		113		113
		d			145		145		145		145		145
		Weight, kg		Standard		11	11.5	18.2	11	11.5	18.2	11	11.5
Certification		Pole		2p	3p	4p	2p	3p	4p	2p	3p	4p	
CE marking		CE			o			o			o		

Note) Depth by door cut size : c1 for large cut, c2 for small cut

For more information

- Drawings ▶ 97 page
- Trip curves ▶ 90 page
- Accessories ▶ 72 page
- Connection and mounting ▶ 111 page

Ordering types

Breaker types

ABN type (37kA/460V)			
Rated current, In	2-pole	3-pole	4-pole
500 A	ABN802c/500	ABN803c/500	ABN804c/500
630 A	ABN802c/630	ABN803c/630	ABN804c/630
700 A	ABN802c/700	ABN803c/700	ABN804c/700
800 A	ABN802c/800	ABN803c/800	ABN804c/800

ABS type (65kA/460V)			
Rated current, In	2-pole	3-pole	4-pole
500 A	ABS802c/500	ABS803c/500	ABS804c/500
630 A	ABS802c/630	ABS803c/630	ABS804c/630
700 A	ABS802c/700	ABS803c/700	ABS804c/700
800 A	ABS802c/800	ABS803c/800	ABS804c/800

ABL type(85kA/460V)			
Rated current, In	2-pole	3-pole	4-pole
500 A	ABL802c/500	ABL803c/500	ABL804c/500
630 A	ABL802c/630	ABL803c/630	ABL804c/630
700 A	ABL802c/700	ABL803c/700	ABL804c/700
800 A	ABL802c/800	ABL803c/800	ABL804c/800

Accessories

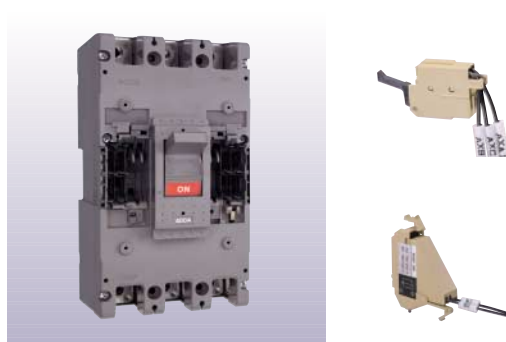

Electrical auxiliaries

AX	Auxiliary Switch
AL	Alarm Switch
SHT	Shunt Trip
UVT	Undervoltage trip

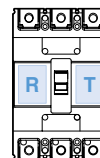

Maximum possibilities

T-position	Option of 2AX, 2AL and SHT or UVT
R-position	Option of 2AX, 2AL and SHT or UVT

Note) For more detail see 73 page

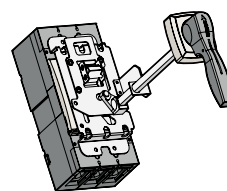

E-80U

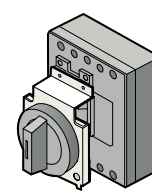

N-80

External accessories

IBL800	Insulation barrier
T1-63A	Terminal cover (Long) - 2, 3pole
T1-64A	Terminal cover (Long) - 4pole
N-80	Rotary handle (Direct)
E-80U	Rotary handle (Extended)
MI-83S	Mechanical interlock - 2, 3pole
MI-84S	Mechanical interlock - 4pole
X-802	Rear terminal - 2pole
X-803	Rear terminal - 3pole
X-804	Rear terminal - 4pole
PB-J3-FR	Plug-in kit

Note) For more detail see 80 page

1000/1200AF MCCB

ABS1000b/1200b, ABL1000b/1200b



Ratings

Frame size		1000AF		1200AF	
Type and Pole		S-Type	L-Type	S-Type	L-Type
	2-pole	-	-	-	-
	3-pole	ABS1003b	ABL1003b	ABS1203b	ABL1203b
	4-pole	ABS1004b	ABL1004b	ABS1204b	ABL1204b
Rated current, I _n		1000A		1200A	
Rated operational voltage, U _e		AC: 600V			
Rated insulation voltage, U _i		690V			
Rated impulse withstand voltage, U _{imp}		6kV			
Rated short-circuit breaking capacity, I_{cu}		S-Type		L-Type	
	AC 690V	45kA		65kA	
	480/500V	50kA		75kA	
	IEC 60947-2 (I _{cu})	65kA		85kA	
	380V	65kA		85kA	
	220/250V	100kA		125kA	
	I _{cs} =100%I _{cu}	50kA		50kA	
Protective function		Overload, Short-circuit			
Type of trip unit		Thermal-Magnetic			
Magnetic trip range		3-6 × I _n			
Endurance	Mechanical	2500 operations			
	Electrical	500 operations			
Connection		Standard			
Mounting		Standard			
Dimensions (mm)		Pole	3p	4p	
	a		220	290	
	b		400	400	
	c		105	105	
	d		159	159	
	Weight, kg	Standard		19.6	25.7
Certification		Pole	3p	4p	
CE marking					

For more information

- Drawings ▶ 98 page
- Trip curves ▶ 91 page

Ordering types

Breaker types

ABS type (65kA/460V)		
Rated current, In	3-pole	4-pole
1000 A	ABS1003b/1000	ABS1004b/1000
1200 A	ABS1203b/1200	ABS1204b/1200

ABL type (85kA/460V)		
Rated current, In	3-pole	4-pole
1000 A	ABL1003b/1000	ABL1004b/1000
1200 A	ABL1203b/1200	ABL1204b/1200

Option of below items for T-position

AX1	Auxiliary Switch (1c)
AX2	Auxiliary Switch (2c)
AL1	Alarm Switch (1c)
AL2	Alarm Switch (2c)
AX1+AL	Auxiliary (1c) + Alarm (1c) Switch
AX2+AL	Auxiliary (2c) + Alarm (1c) Switch

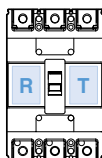

Option of below items for R-position

SHT	Shunt Trip
UVT	Undervoltage trip

Contact operation for Auxiliary and Alarm Switches

MCCB	ON	OFF	TRIP
AX			
AL			

Contact rating for Auxiliary and Alarm Switches

Voltage (V)	AC		DC		
	Current (A)		Voltage (V)	Current (A)	
	Resistive load	Inductive load		Resistive load	Inductive load
125	20	20	30	6	5
250	20	20	125	0.4	0.05
500	10	5	250	0.2	0.03

Rating for Shunt trip (SHT)

	Control voltage	Time rating	Operational voltage
AC	100~110V 200~220V 380~440V	Continuous	85~110% of control voltage
DC	48V 100~110V 200~220V		75~125% of control voltage

Rating for Undervoltage release (UVT)

	Control voltage	Time rating	Operational voltage	Trip voltage
AC	100~110V 200~220V 380~440V	Continuous	85~110% of control voltage	20~70% of control voltage
DC	100V 200V		85~125% of control voltage	20~70% of control voltage

1200AF 전자식 MCCB

ABS1203bE

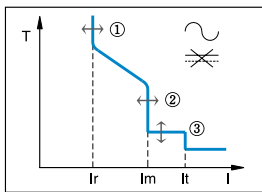
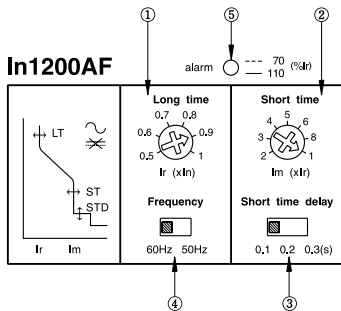

For more information

- Drawings ▶ 99 page
- Trip curves ▶ 92 page

Ratings

Frame size		1200AF	
Type and Pole		S-Type	
	2-pole	-	
	3-pole	ABS1203bE	
	4-pole	-	
Rated current, In		1200A	
Rated operational voltage, Ue		AC: 600V	
Rated insulation voltage, Ui		AC: 600V	
Rated impulse withstand voltage, Uimp		6kV	
Type	Long time	Current, IR	(0.5-0.6-0.7-0.8-0.9-1.0) × In, adjustable...①
	pick-up	time	5sec ± 20% at 6 × Ir, fixed
	Short time	Current, Im	(2-3-4-5-6-8-10) × In, adjustable...②
	pick-up	time	0.1-0.2-0.3 sec, adjustable...③
	Instantaneous	Current, It	11 × In, fixed
	pick-up	time	within 0.03 sec, fixed
⑤ LED	Pre-Alarm		between 70 to 110% of set current Ir: LED flickering over 110% of set current Ir: stays on
④ Rated frequency			50-60Hz selectable by the switch of the trip unit
Rated short-circuit breaking capacity, Icu		S-Type	
	AC 690V	45kA	
	480/500V	50kA	
	415/460V	65kA	
	380V	65kA	
	220/250V	100kA	
Ics=100%Icu		50%	
Protective function		Overload, Short-circuit	
Type of trip unit		Electronic type	
Endurance	Mechanical	2500 operations	
	Electrical	500 operations	
Connection	Standard	Front connection	
Mounting	Standard	Screw fixing	
Dimensions (mm)		Pole	3p
	a	220	
	b	400	
	c	105	
	d	159	
Weight, kg	Standard	21	

Ordering types

Breaker types

ABS type (65kA/460V)	
Rated current, In	3P
1200 A	ABS1203bE

Option of below items for T-position

AX1	Auxiliary Switch (1c)
AX2	Auxiliary Switch (2c)
AL1	Alarm Switch (1c)
AL2	Alarm Switch (2c)
AX1+AL	Auxiliary (1c) + Alarm (1c) Switch
AX2+AL	Auxiliary (2c) + Alarm (1c) Switch

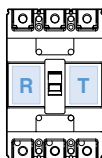

Option of below items for R-position

SHT	Shunt Trip
UVT	Undervoltage trip

Contact operation for Auxiliary and Alarm Switches

MCCB	ON	OFF	TRIP
AX			
AL			

Contact rating for Auxiliary and Alarm Switches

Voltage (V)	AC		DC		Inductive load
	Current (A)		Voltage (V)	Current (A)	
	Resistive load			Resistive load	
125	20	20	30	6	5
250	20	20	125	0.4	0.05
500	10	5	250	0.2	0.03

Rating for Shunt trip (SHT)

	Control voltage	Time rating	Operational voltage
AC	100~110V 200~220V 380~440V	Continuous	85~110% of control voltage
DC	48V 100~110V 200~220V		75~125% of control voltage

Rating for Undervoltage release (UVT)

	Control voltage	Time rating	Operational voltage	Trip voltage
AC	100~110V 200~220V 380~440V	Continuous	85~110% of control voltage	20~70% of control voltage
DC	100V 200V		85~125% of control voltage	20~70% of control voltage

30AF ELCB

EBS30c

Metasol



EBS33c

Ratings

Frame size		30AF	
Type and Pole		S-Type	
	2-pole(2-sensor)	-	
	3-pole(3-sensor)	EBS33c	
	4-pole(3-sensor)	EBS34c	
Rated current, I _n		15-20-30A	
Rated residual current, I _{Δn}		30, 100/200/500mA (Adjustable)	
Residual current off-time at I _{Δn}		≤0.1 sec	
Rated operational voltage, U _e		AC: 220/460V	
Rated impulse withstand voltage, U _{imp}		6kV	
Wiring system	2-pole(2-sensor)	-	
	3-pole(3-sensor)	1 ∅ 2W, 1 ∅ 3W, 3 ∅ 3W	
	4-pole(3-sensor)	1 ∅ 2W, 1 ∅ 3W, 3 ∅ 3W, 3 ∅ 4W	
Rated short-circuit breaking capacity, I_{cu}		S-Type	
AC	460V	14 kA	
IEC 60947-2 (I _{cu})	415V	14 kA	
I _{cs} =100%I _{cu}	220/250V	30 kA	
Protective function		Overload, Short-circuit and Ground fault	
Type of trip unit		Thermal-Magnetic	
Magnetic trip range		400A	
Endurance	Mechanical	25000 operations	
	Electrical	10000 operations	
Connection	Standard	Front connection	
	Optional	Rear connection	
Mounting		Plug-in	
Standard		Screw fixing	
Dimensions (mm)			
	Pole	3p	4p
	a	75	100
	b	130	130
	c1 <small>Note)</small>	60	60
	c2 <small>Note)</small>	64	64
	d	82	82
Weight, kg	Standard	0.7	0.9
Certification			
Pole		3p	4p
CE marking		○	○

Note) Depth by door cut size : c1 for large cut, c2 for small cut

For more information

- Drawings ▶ 100 page
- Trip curves ▶ 87 page
- Accessories ▶ 72 page
- Connection and mounting ▶ 110 page

Ordering types

Breaker types

EBS type (14kA/460V)		
Rated current, I _n	Rated residual current, I _{Δn} : 30mA	
	3-pole	4-pole
15 A	EBS33c/15/30	EBS34c/15/30
20 A	EBS33c/20/30	EBS34c/20/30
30 A	EBS33c/30/30	EBS34c/30/30

EBS type (14kA/460V)		
Rated current, I _n	Rated residual current, I _{Δn} : 100/200/500mA	
	3-pole	4-pole
15 A	EBS33c/15/100	EBS34c/15/100
20 A	EBS33c/20/100	EBS34c/20/100
30 A	EBS33c/30/100	EBS34c/30/100

Accessories

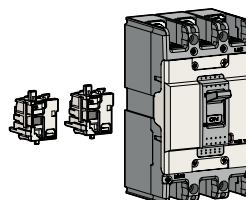

Electrical auxiliaries

AX	Auxiliary Switch
AL	Alarm Switch
AX+AL	Combination switch

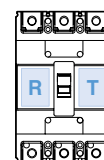

Maximum possibilities

T-position	Not available
R-position	Option of AX or AL or AX+AL

Note) For more detail see 72 page

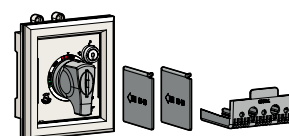
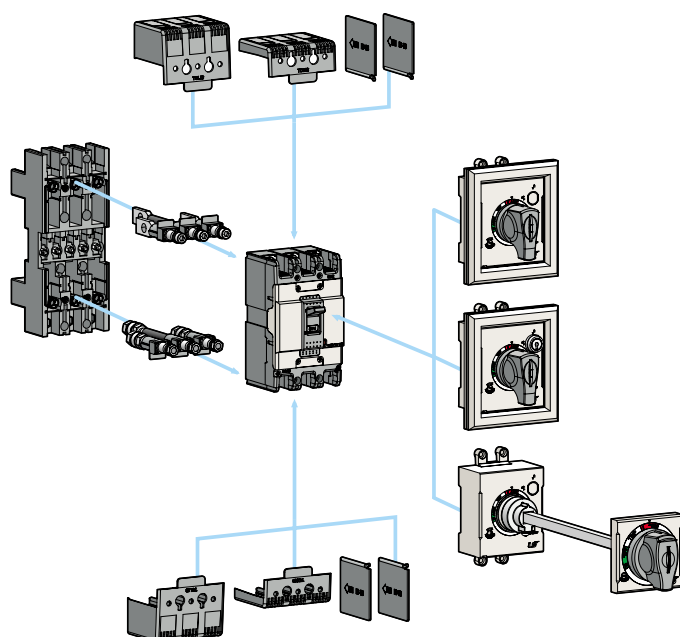

External accessories

EBS30c	Name
IB13	Insulation barrier
TCL13	Terminal cover (Long)
TCS13	Terminal cover (Short)
DH100	Rotary handle (Direct)
DHK100	Rotary handle (Direct, Key lock)
EH100	Rotary handle (Extended)
RTR1	Rear terminal (Round)
PB-A3	Plug-in kit
PHL100	Pad handle lock

Note) For more detail see 80 page

50AF ELCB

EBN50c, EBS50c, EBH50c



EBN53c



EBS53c

Ratings

Frame size		50AF													
Type and Pole		N-Type		S-Type		H-Type									
2-pole(2-sensor)		EBN52c		-		-									
3-pole(3-sensor)		EBN53c		EBS53c		EBH53c									
4-pole(3-sensor)		-		EBS54c		EBH54c									
Rated current, I _n		15-20-30-40-50A													
Rated residual current, I _{Δn}		30, 100/200/500mA (Adjustable)													
Residual current off-time at I _{Δn}		≤0.1 sec													
Rated operational voltage, U _e		AC: 220/460V													
Rated impulse withstand voltage, U _{imp}		6kV													
Wiring system		2-pole(2-sensor)		1 Ø 2W											
		3-pole(3-sensor)		1 Ø 2W, 1 Ø 3W, 3 Ø 3W											
		4-pole(3-sensor)		1 Ø 2W, 1 Ø 3W, 3 Ø 3W, 3 Ø 4W											
Rated short-circuit breaking capacity, I_{cu}		N-Type		S-Type		H-Type									
AC 460V		14kA		18kA		50kA									
IEC 60947-2 (I _{cu})		415V		18kA		50kA									
I _{cs} =100%I _{cu}		220/250V		35kA		100kA									
Protective function		Overload, Short-circuit and Ground fault													
Type of trip unit		Thermal-Magnetic													
Magnetic trip range		12 × I _n (30A and under: 400A)													
Endurance		Mechanical		25000 operations											
		Electrical		10000 operations											
Connection		Standard		Front connection											
		Optional		Rear connection											
				Plug-in											
Mounting		Standard		Screw fixing											
Dimensions (mm)		Pole		2p		3p		3p		4p		3p		4p	
		a		75		75		75		100		90		120	
		b		130		130		130		130		155		155	
		c1 <small>Note</small>		60		60		60		60		60		60	
		c2 <small>Note</small>		64		64		64		64		64		64	
		d		82		82		82		82		82		82	
Weight, kg		Standard		0.5		0.7		0.7		0.9		1		1.2	
Certification		Pole		2p		3p		3p		4p		3p		4p	
CE marking		CE		○		○		○		○		○		○	

Note) Depth by door cut size : C1 for large cut, C2 for small cut

For more information

- Drawings ▶ 100 page
- Trip curves ▶ 87, 88 page
- Accessories ▶ 72 page
- Connection and mounting ▶ 110 page

Ordering types

Breaker types

EBN type (14kA/460V)				
Rated current, In	Rated residual current, I Δ n: 30mA		Rated residual current, I Δ n: 100/200/500mA	
	2-pole	3-pole	2-pole	3-pole
15 A	EBN52c/15/30	EBN53c/15/30	EBN52c/15/100	EBN53c/15/100
20 A	EBN52c/20/30	EBN53c/20/30	EBN52c/20/100	EBN53c/20/100
30 A	EBN52c/30/30	EBN53c/30/30	EBN52c/30/100	EBN53c/30/100
40 A	EBN52c/40/30	EBN53c/40/30	EBN52c/40/100	EBN53c/40/100
50 A	EBN52c/50/30	EBN53c/50/30	EBN52c/50/100	EBN53c/50/100

EBS type (18kA/460V)				
Rated current, In	Rated residual current, I Δ n: 30mA		Rated residual current, I Δ n: 100/200/500mA	
	3-pole	4-pole	3-pole	4-pole
15 A	EBS53c/15/30	EBS54c/15/30	EBS53c/15/100	EBS54c/15/100
20 A	EBS53c/20/30	EBS54c/20/30	EBS53c/20/100	EBS54c/20/100
30 A	EBS53c/30/30	EBS54c/30/30	EBS53c/30/100	EBS54c/30/100
40 A	EBS53c/40/30	EBS54c/40/30	EBS53c/40/100	EBS54c/40/100
50 A	EBS53c/50/30	EBS54c/50/30	EBS53c/50/100	EBS54c/50/100

EBH type (37kA/460V)				
Rated current, In	Rated residual current, I Δ n: 30mA		Rated residual current, I Δ n: 100/200/500mA	
	3-pole	4-pole	3-pole	4-pole
15 A	EBH53c/15/30	EBH54c/15/30	EBH53c/15/100	EBH54c/15/100
20 A	EBH53c/20/30	EBH54c/20/30	EBH53c/20/100	EBH54c/20/100
30 A	EBH53c/30/30	EBH54c/30/30	EBH53c/30/100	EBH54c/30/100
40 A	EBH53c/40/30	EBH54c/40/30	EBH53c/40/100	EBH54c/40/100
50 A	EBH53c/50/30	EBH54c/50/30	EBH53c/50/100	EBH54c/50/100

Accessories

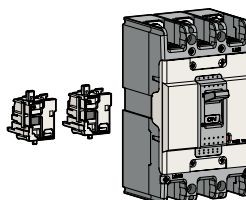

Electrical auxiliaries

AX	Auxiliary Switch
AL	Alarm Switch
AX+AL	Combination switch

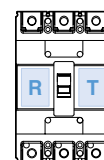

Maximum possibilities

T-position	Not available
R-position	Option of AX or AL or AX+AL

Note) For more detail see 72 page

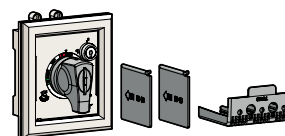

External accessories

EBN50c EBS50c	EBH50c	Name
IB13	IB23	Insulation barrier
TCL13	TCL23	Terminal cover (Long)
TCS13	TCS23	Terminal cover (Short)
DH100	DH125	Rotary handle (Direct)
DHK100	DHK125	Rotary handle (Direct, Key lock)
EH100	EH125	Rotary handle (Extended)
-	RTB2	Rear terminal (Bar)
RTR1	RTR2	Rear terminal (Round)
PB-A3	PB-C3	Plug-in kit
PHL100	PHL125	Pad handle lock

Note) For more detail see 80 page

60AF ELCB

EBN60c, EBS60c



EBN63c



EBS63c

Ratings

Frame size		60AF			
Type and Pole		N-Type		S-Type	
2-pole(2-sensor)		-		-	
3-pole(3-sensor)		EBN63c		EBS63c	
4-pole(3-sensor)		-		EBS64c	
Rated current, I _n		60A			
Rated residual current, I _{Δn}		30, 100/200/500mA (Adjustable)			
Residual current off-time at I _{Δn}		≤0.1 sec			
Rated operational voltage, U _e		AC: 220/460V			
Rated impulse withstand voltage, U _{imp}		6kV			
Wiring system	2-pole(2-sensor)	-			
	3-pole(3-sensor)	1 ∅ 2W, 1 ∅ 3W, 3 ∅ 3W			
	4-pole(3-sensor)	1 ∅ 2W, 1 ∅ 3W, 3 ∅ 3W, 3 ∅ 4W			
Rated short-circuit breaking capacity, I_{cu}		N-Type		S-Type	
AC	460V	14kA		18kA	
IEC 60947-2 (I _{cu})	415V	14kA		18kA	
I _{cs} =100%I _{cu}	220/250V	30kA		35kA	
Protective function		Overload, Short-circuit and Ground fault			
Type of trip unit		Thermal-Magnetic			
Magnetic trip range		12 × I _n			
Endurance	Mechanical	25000 operations			
	Electrical	10000 operations			
Connection	Standard	Front connection			
	Optional	Rear connection			
Mounting	Standard	Plug-in			
		Screw fixing			
Dimensions (mm)		Pole	3p	3p	4p
		a	75	75	100
		b	130	130	130
		c1 <small>Note</small>	60	60	60
		c2 <small>Note</small>	64	64	64
		d	82	82	82
		Weight, kg	Standard	0.7	0.7
Certification		Pole	3p	3p	4p
CE marking		CE	○	○	○

Note) Depth by door cut size : C1 for large cut, C2 for small cut

For more information

- Drawings ▶ 100 page
- Trip curves ▶ 87 page
- Accessories ▶ 72 page
- Connection and mounting ▶ 110 page

Ordering types

Breaker types

EBN type (14kA/460V)			
Rated current, I _n	Rated residual current, I _{Δn} : 30mA		Rated residual current, I _{Δn} : 100/200/500mA
	3-pole		3-pole
60 A	EBS63c/60/30		EBS63c/60/100

EBS type (18kA/460V)				
Rated current, I _n	Rated residual current, I _{Δn} : 30mA		Rated residual current, I _{Δn} : 100/200/500mA	
	3-pole	4-pole	3-pole	4-pole
60 A	EBS63c/60/30	EBS64c/60/30	EBS63c/60/100	EBS64c/60/100

Accessories

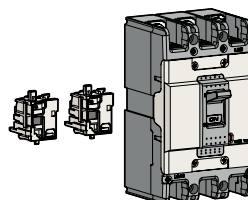

Electrical auxiliaries

AX	Auxiliary Switch
AL	Alarm Switch
AX+AL	Combination switch

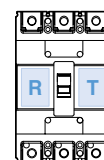

Maximum possibilities

T-position	Not available
R-position	Option of AX or AL or AX+AL

Note) For more detail see 72 page

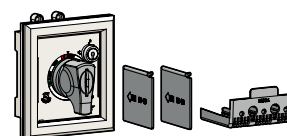
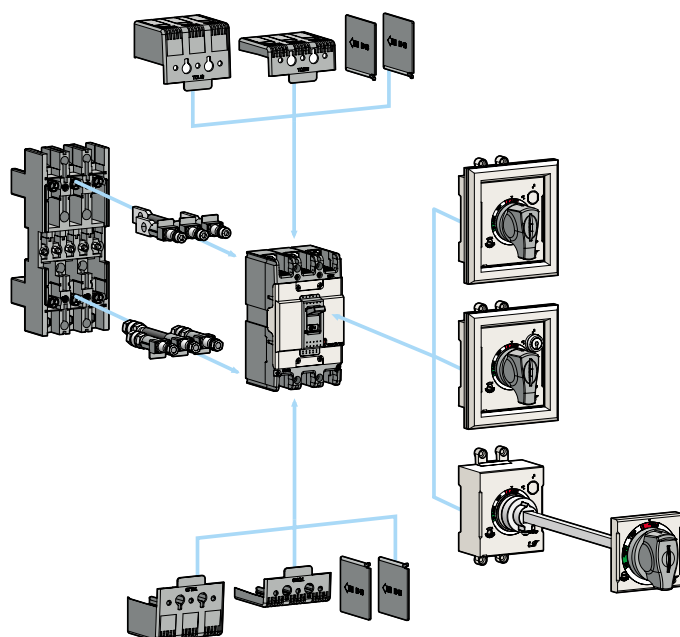

External accessories

EBS60c EBN60c	Name
IB13	Insulation barrier
TCL13	Terminal cover (Long)
TCS13	Terminal cover (Short)
DH100	Rotary handle (Direct)
DHK100	Rotary handle (Direct, Key lock)
EH100	Rotary handle (Extended)
RTB1	Rear terminal (Bar)
RTR1	Rear terminal (Round)
PB-A3	Plug-in kit
PHL100	Pad handle lock

Note) For more detail see 80 page

100AF ELCB

EBN100c

Metasol



EBN103c

Ratings

Frame size		100AF			
Type and Pole		N-Type			
	2-pole(2-sensor)				EBN102c
	3-pole(3-sensor)				EBN103c
	4-pole(3-sensor)				EBN104c
Rated current, I _n		60-75-100A			
Rated residual current, I _{Δn}		30, 100/200/500mA (Adjustable)			
Residual current off-time at I _{Δn}		≤ 0.1 sec			
Rated operational voltage, U _e		AC: 220/460V			
Rated impulse withstand voltage, U _{imp}		6kV			
Wiring system	2-pole(2-sensor)				1 ∅ 2W
	3-pole(3-sensor)				1 ∅ 2W, 1 ∅ 3W, 3 ∅ 3W
	4-pole(3-sensor)				1 ∅ 2W, 1 ∅ 3W, 3 ∅ 3W, 3 ∅ 4W
Rated short-circuit breaking capacity, I_{cu}		N-Type			
	AC 460V				18kA
	IEC 60947-2 (I _{cu})	415V			18kA
	I _{cs} =100%I _{cu}	220/250V			35kA
Protective function		Overload, Short-circuit and Ground fault			
Type of trip unit		Thermal-Magnetic			
Magnetic trip range		12 × I _n			
Endurance	Mechanical	25000 operations			
	Electrical	10000 operations			
Connection	Standard	Front connection			
	Optional	Rear connection			
Mounting		Plug-in			
	Standard	Screw fixing			
Dimensions (mm)		Pole	2p	3p	4p
	a		75	75	100
	b		130	130	130
	c1 <small>Note)</small>		60	60	60
	c2 <small>Note)</small>		64	64	64
	d		82	82	82
	Weight, kg	Standard	0.5	0.7	0.9
Certification		Pole	2p	3p	4p
CE marking		CE	○	○	○

Note) Depth by door cut size : c1 for large cut, c2 for small cut

For more information

- Drawings ▶ 100 page
- Trip curves ▶ 87 page
- Accessories ▶ 72 page
- Connection and mounting ▶ 110 page

Ordering types

Breaker types

EBN type (18kA/460V)			
Rated current, I _n	Rated residual current, I _{Δn} : 30mA		
	2-pole	3-pole	4-pole
60 A	EBN102c/60/30	EBN103c/60/30	EBN104c/60/30
75 A	EBN102c/75/30	EBN103c/75/30	EBN104c/75/30
100 A	EBN102c/100/30	EBN103c/100/30	EBN104c/100/30

Rated current, I _n	Rated residual current, I _{Δn} : 100/200/500mA		
	2-pole	3-pole	4-pole
60 A	EBN102c/60/100	EBN103c/60/100	EBN104c/60/100
75 A	EBN102c/75/100	EBN103c/75/100	EBN104c/75/100
100 A	EBN102c/100/100	EBN103c/100/100	EBN104c/100/100

Accessories

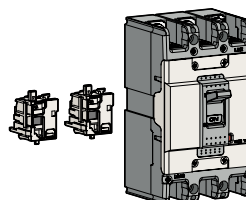

Electrical auxiliaries

AX	Auxiliary Switch
AL	Alarm Switch
AX+AL	Combination switch

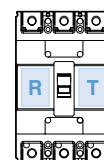

Maximum possibilities

T-position	Not available
R-position	Option of AX or AL or AX+AL

Note) For more detail see 72 page

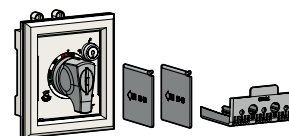
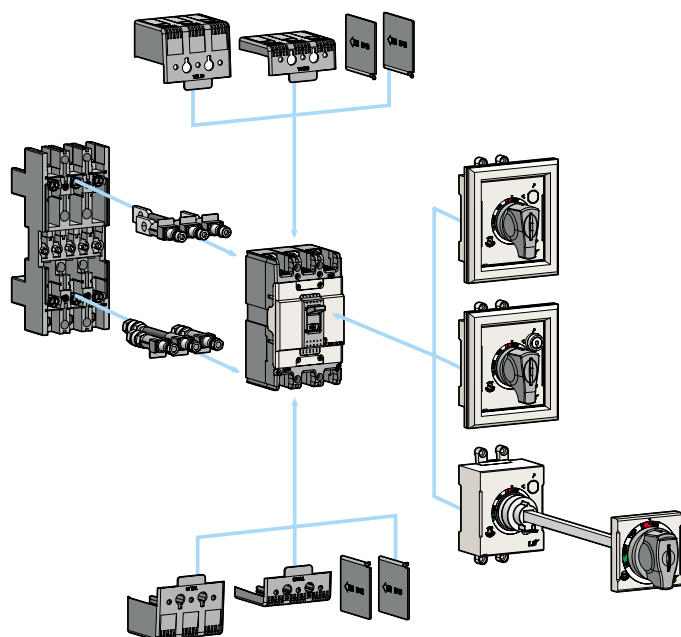

External accessories

EBN100c	Name
IB13	Insulation barrier
TCL13	Terminal cover (Long)
TCS13	Terminal cover (Short)
DH100	Rotary handle (Direct)
DHK100	Rotary handle (Direct, Key lock)
EH100	Rotary handle (Extended)
RTB1	Rear terminal (Bar)
RTR1	Rear terminal (Round)
PB-A3	Plug-in kit
PHL100	Pad handle lock

Note) For more detail see 80 page

125AF ELCB

EBS125c, EBH125c



EBS103c



EBH103c

Ratings

Frame size		125AF				
Type and Pole		S-Type		H-Type		
2-pole(2-sensor)		-		-		
3-pole(3-sensor)		EBS103c		EBH103c		
4-pole(3-sensor)		EBS104c		EBH104c		
Rated current, I _n		15-20-30-40-50-60-75-100-125A				
Rated residual current, I _{Δn}		30, 100/200/500mA (Adjustable)				
Residual current off-time at I _{Δn}		≤ 0.1 sec				
Rated operational voltage, U _e		AC: 220/460V				
Rated impulse withstand voltage, U _{imp}		6kV				
Wiring system		2-pole(2-sensor)		-		
		3-pole(3-sensor)		1 ∅ 2W, 1 ∅ 3W, 3 ∅ 3W		
		4-pole(3-sensor)		1 ∅ 2W, 1 ∅ 3W, 3 ∅ 3W, 3 ∅ 4W		
Rated short-circuit breaking capacity, I_{cu}		S-Type		H-Type		
AC 460V		37kA		50kA		
IEC 60947-2 (I _{cu})		415V		50kA		
I _{cs} =100%I _{cu}		220/250V		100kA		
Protective function		Overload, Short-circuit and Ground fault				
Type of trip unit		Thermal-Magnetic				
Magnetic trip range		12 × I _n (30A and under: 400A)				
Endurance		Mechanical		25000 operations		
		Electrical		10000 operations		
Connection		Standard		Front connection		
		Optional		Rear connection		
		Plug-in				
Mounting		Standard		Screw fixing		
Dimensions (mm)		Pole	3p	4p	3p	4p
		a	90	120	90	120
		b	155	155	155	155
		c1 <small>Note)</small>	60	60	60	60
		c2 <small>Note)</small>	64	64	64	64
		d	82	82	82	82
		Weight, kg	Standard	1	1.2	1
Certification		Pole	3p	4p	3p	4p
CE marking		CE	○	○	○	○

Note) Depth by door cut size : c1 for large cut, c2 for small cut

For more information

- Drawings ▶ 101 page
- Trip curves ▶ 88 page
- Accessories ▶ 72 page
- Connection and mounting ▶ 110 page

Ordering types

Breaker types

EBS type (37kA/460V)				
Rated current, I _n	Rated residual current, I _{Δn} : 30mA		Rated residual current, I _{Δn} : 100/200/500mA	
	3-pole	4-pole	3-pole	4-pole
15 A	EBS103c/15/30	EBS104c/15/30	EBS103c/15/100	EBS104c/15/100
20 A	EBS103c/20/30	EBS104c/20/30	EBS103c/20/100	EBS104c/20/100
30 A	EBS103c/30/30	EBS104c/30/30	EBS103c/30/100	EBS104c/30/100
40 A	EBS103c/40/30	EBS104c/40/30	EBS103c/40/100	EBS104c/40/100
50 A	EBS103c/50/30	EBS104c/50/30	EBS103c/50/100	EBS104c/50/100
60 A	EBS103c/60/30	EBS104c/60/30	EBS103c/60/100	EBS104c/60/100
75 A	EBS103c/75/30	EBS104c/75/30	EBS103c/75/100	EBS104c/75/100
100 A	EBS103c/100/30	EBS104c/100/30	EBS103c/100/100	EBS104c/100/100
125 A	EBS103c/125/30	EBS104c/125/30	EBS103c/125/100	EBS104c/125/100

EBH type (50kA/460V)				
Rated current, I _n	Rated residual current, I _{Δn} : 30mA		Rated residual current, I _{Δn} : 100/200/500mA	
	3-pole	4-pole	3-pole	4-pole
15 A	EBH103c/15/30	EBH104c/15/30	EBH103c/15/100	EBH104c/15/100
20 A	EBH103c/20/30	EBH104c/20/30	EBH103c/20/100	EBH104c/20/100
30 A	EBH103c/30/30	EBH104c/30/30	EBH103c/30/100	EBH104c/30/100
40 A	EBH103c/40/30	EBH104c/40/30	EBH103c/40/100	EBH104c/40/100
50 A	EBH103c/50/30	EBH104c/50/30	EBH103c/50/100	EBH104c/50/100
60 A	EBH103c/60/30	EBH104c/60/30	EBH103c/60/100	EBH104c/60/100
75 A	EBH103c/75/30	EBH104c/75/30	EBH103c/75/100	EBH104c/75/100
100 A	EBH103c/100/30	EBH104c/100/30	EBH103c/100/100	EBH104c/100/100
125 A	EBH103c/125/30	EBH104c/125/30	EBH103c/125/100	EBH104c/125/100

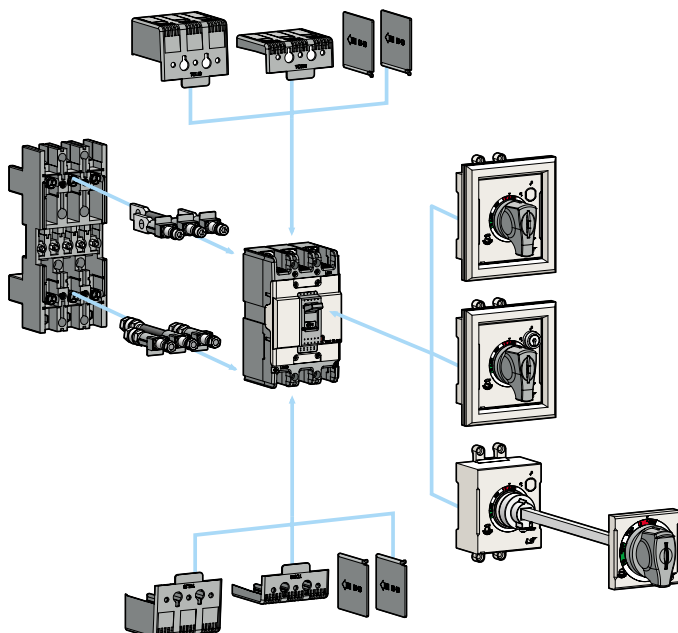

Accessories

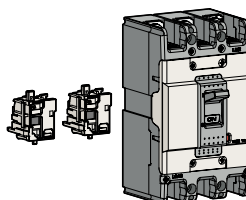

Electrical auxiliaries

AX	Auxiliary Switch
AL	Alarm Switch
AX+AL	Combination switch

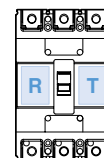

Maximum possibilities

T-position	Not available
R-position	Option of AX or AL or AX+AL

Note) For more detail see 72 page

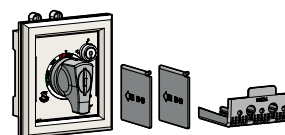

External accessories

EBS125c EBH125c	Name
IB23	Insulation barrier
TCL23	Terminal cover (Long)
TCS23	Terminal cover (Short)
DH125	Rotary handle (Direct)
DHK125	Rotary handle (Direct, Key lock)
EH125	Rotary handle (Extended)
RTB2	Rear terminal (Bar)
RTR2	Rear terminal (Round)
PB-C3	Plug-in kit
PHL125	Pad handle lock

Note) For more detail see 80 page

250AF ELCB

EBN250c, EBS250c, EBH250c



EBN203c



EBS203c

Ratings

Frame size		250AF						
Type and Pole		N-Type		S-Type		H-Type		
	2-pole(2-sensor)	EBN202c		-		-		
	3-pole(3-sensor)	EBN203c		EBS203c		EBH203c		
	4-pole(3-sensor)	-		EBS204c		EBH204c		
Rated current, I _n		100-125-150-175-200-225-250A						
Rated residual current, I _{Δn}		30, 100/200/500mA (Adjustable)						
Residual current off-time at I _{Δn}		≤ 0.1 sec						
Rated operational voltage, U _e		AC: 220/460V						
Rated impulse withstand voltage, U _{imp}		6kV						
Wiring system	2-pole(2-sensor)	1 ∅ 2W						
	3-pole(3-sensor)	1 ∅ 2W, 1 ∅ 3W, 3 ∅ 3W						
	4-pole(3-sensor)	1 ∅ 2W, 1 ∅ 3W, 3 ∅ 3W, 3 ∅ 4W						
Rated short-circuit breaking capacity, I_{cu}		N-Type		S-Type		H-Type		
	AC 460V	26kA		37kA		50kA		
	IEC 60947-2 (I _{cu})	415V		37kA		50kA		
	I _{cs} =100%I _{cu}	220/250V		85kA		100kA		
Protective function		Overload, Short-circuit and Ground fault						
Type of trip unit		Thermal-Magnetic						
Magnetic trip range		12 × I _n						
Endurance	Mechanical	20000 operations						
	Electrical	5000 operations						
Connection	Standard	Front connection						
	Optional	Rear connection						
		Plug-in						
Mounting	Standard	Screw fixing						
Dimensions (mm)		Pole	2p	3p	3p	4p	3p	4p
	a		105	105	105	140	105	140
	b		165		165		165	
	c1 <small>Note)</small>		60		60		60	
	c2 <small>Note)</small>		64		64		64	
	d		87		87		87	
	Weight, kg	Standard	1.1	1.2	1.2	1.5	1.2	1.5
Certification		Pole	2p	3p	3p	4p	3p	4p
CE marking			○		○		○	

Note) Depth by door cut size : c1 for large cut, c2 for small cut

For more information

- Drawings ▶ 102 page
- Trip curves ▶ 89 page
- Accessories ▶ 72 page
- Connection and mounting ▶ 110 page

Ordering types

Breaker types

EBN type (25kA/460V)				
Rated current, In	Rated residual current, I Δ n: 30mA		Rated residual current, I Δ n: 100/200/500mA	
	2-pole	3-pole	2-pole	3-pole
100 A	EBN202c/100/30	EBN203c/100/30	EBN202c/100/100	EBN203c/100/100
125 A	EBN202c/125/30	EBN203c/125/30	EBN202c/125/100	EBN203c/125/100
150 A	EBN202c/150/30	EBN203c/150/30	EBN202c/150/100	EBN203c/150/100
175 A	EBN202c/175/30	EBN203c/175/30	EBN202c/175/100	EBN203c/175/100
200 A	EBN202c/200/30	EBN203c/200/30	EBN202c/200/100	EBN203c/200/100
225 A	EBN202c/225/30	EBN203c/225/30	EBN202c/225/100	EBN203c/225/100
250 A	EBN202c/250/30	EBN203c/250/30	EBN202c/250/100	EBN203c/250/100

EBS type (37kA/460V)				
Rated current, In	Rated residual current, I Δ n: 30mA		Rated residual current, I Δ n: 100/200/500mA	
	3-pole	4-pole	3-pole	4-pole
100 A	EBS203c/100/30	EBS204c/100/30	EBS203c/100/100	EBS204c/100/100
125 A	EBS203c/125/30	EBS204c/125/30	EBS203c/125/100	EBS204c/125/100
150 A	EBS203c/150/30	EBS204c/150/30	EBS203c/150/100	EBS204c/150/100
175 A	EBS203c/175/30	EBS204c/175/30	EBS203c/175/100	EBS204c/175/100
200 A	EBS203c/200/30	EBS204c/200/30	EBS203c/200/100	EBS204c/200/100
225 A	EBS203c/225/30	EBS204c/225/30	EBS203c/225/100	EBS204c/225/100
250 A	EBS203c/250/30	EBS204c/250/30	EBS203c/250/100	EBS204c/250/100

EBH type (50kA/460V)				
Rated current, In	Rated residual current, I Δ n: 30mA		Rated residual current, I Δ n: 100/200/500mA	
	3-pole	4-pole	3-pole	4-pole
100 A	EBH203c/100/30	EBH204c/100/30	EBH203c/100/100	EBH204c/100/100
125 A	EBH203c/125/30	EBH204c/125/30	EBH203c/125/100	EBH204c/125/100
150 A	EBH203c/150/30	EBH204c/150/30	EBH203c/150/100	EBH204c/150/100
175 A	EBH203c/175/30	EBH204c/175/30	EBH203c/175/100	EBH204c/175/100
200 A	EBH203c/200/30	EBH204c/200/30	EBH203c/200/100	EBH204c/200/100
225 A	EBH203c/225/30	EBH204c/225/30	EBH203c/225/100	EBH204c/225/100
250 A	EBH203c/250/30	EBH204c/250/30	EBH203c/250/100	EBH204c/250/100

Accessories

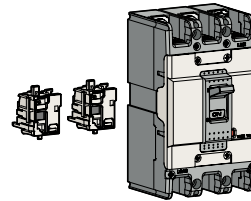

Electrical auxiliaries

AX	Auxiliary Switch
AL	Alarm Switch
AX+AL	Combination switch

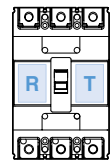

Maximum possibilities

T-position	Not available
R-position	Option of AX or AL or AX+AL

Note) For more detail see 72 page

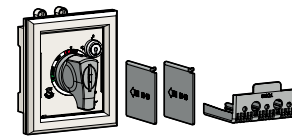

External accessories

EBN250c EBS250c EBH250c	Name
IB23	Insulation barrier
TCL33	Terminal cover (Long)
TCS33	Terminal cover (Short)
DH250	Rotary handle (Direct)
DHK250	Rotary handle (Direct, Key lock)
EH250	Rotary handle (Extended)
RTB3	Rear terminal (Bar)
RTR3	Rear terminal (Round)
PB-D3	Plug-in kit
PHL250	Pad handle lock

Note) For more detail see 80 page

400AF ELCB

EBN400c, EBS400c, EBH400c, EBL400c



EBS403c



EBL404c

Ratings

Frame size		400AF								
Type and Pole		N-Type		S-Type		H-Type		L-Type		
	3-pole(3-sensor)	EBN403c		EBS403c		EBH403c		EBL403c		
	4-pole(3-sensor)	EBN404c		EBS404c		EBH404c		EBL404c		
Rated current, I _n	250-300-350-400A									
Rated residual current, I _{Δn}	30, 100/200/500mA (Adjustable)									
Residual current off-time at I _{Δn}	≤0.1 sec									
Rated operational voltage, U _e	220/460V									
Rated impulse withstand voltage, U _{imp}	6kV									
Wiring system	3-pole(3-sensor)	1 ∅ 2W, 1 ∅ 3W, 3 ∅ 3W								
	4-pole(3-sensor)	1 ∅ 2W, 1 ∅ 3W, 3 ∅ 3W, 3 ∅ 4W								
Rated short-circuit breaking capacity, I_{cu}		N-Type		S-Type		H-Type		L-Type		
AC	415/460V	37kA		50kA		65kA		85kA		
IEC 60947-2 (I _{cu})	220/250V	50kA		75kA		85kA		125kA		
I _{cs} =%I _{cu}		100%		100%		100%		75%		
Protective function		Overload, Short-circuit and Ground fault								
Type of trip unit	Thermal-Magnetic									
Magnetic trip range	8~12I _n									
Endurance	Mechanical	4000 operations								
	Electrical	1000 operations								
Connection	Standard	Front connection								
	Optional	Rear connection								
		Plug-in								
Mounting	Standard	Screw fixing								
Dimensions (mm)		Pole	3p	4p	3p	4p	3p	4p	3p	4p
		a	140	184	140	184	140	184	140	184
		b	257		257		257		257	
		c1 <small>Note)</small>	109		109		109		109	
		c2 <small>Note)</small>	113		113		113		113	
		d	145		145		145		145	
		Weight, kg	Standard	7	8.4	7	8.4	7	8.4	7
Certification		Pole	3p	4p	3p	4p	3p	4p	3p	4p
CE marking		CE	-	-	-	-	-	-	-	-

Note) Depth by door cut size : c1 for large cut, c2 for small cut

For more information

- Drawings ▶ 103 page
- Trip curves ▶ 90 page
- Accessories ▶ 72 page
- Connection and mounting ▶ 110 page

Ordering types

Breaker types

EBN type (25kA/460V)				
Rated current, In	Rated residual current, I Δ n: 30mA		Rated residual current, I Δ n: 100/200/500mA	
	3-pole	4-pole	3-pole	4-pole
250 A	EBN403c/250/30	EBN404c/250/30	EBN403c/250/100	EBN404c/250/100
300 A	EBN403c/300/30	EBN404c/300/30	EBN403c/300/100	EBN404c/300/100
350 A	EBN403c/350/30	EBN404c/350/30	EBN403c/350/100	EBN404c/350/100
400 A	EBN403c/400/30	EBN404c/400/30	EBN403c/400/100	EBN404c/400/100

EBS type (50kA/460V)				
Rated current, In	Rated residual current, I Δ n: 30mA		Rated residual current, I Δ n: 100/200/500mA	
	3-pole	4-pole	3-pole	4-pole
250 A	EBS403c/250/30	EBS404c/250/30	EBS403c/250/100	EBS404c/250/100
300 A	EBS403c/300/30	EBS404c/300/30	EBS403c/300/100	EBS404c/300/100
350 A	EBS403c/350/30	EBS404c/350/30	EBS403c/350/100	EBS404c/350/100
400 A	EBS403c/400/30	EBS404c/400/30	EBS403c/400/100	EBS404c/400/100

EBH type(65kA/460V)				
Rated current, In	Rated residual current, I Δ n: 30mA		Rated residual current, I Δ n: 100/200/500mA	
	3-pole	4-pole	3-pole	4-pole
250 A	EBH403c/250/30	EBH404c/250/30	EBH403c/250/100	EBH404c/250/100
300 A	EBH403c/300/30	EBH404c/300/30	EBH403c/300/100	EBH404c/300/100
350 A	EBH403c/350/30	EBH404c/350/30	EBH403c/350/100	EBH404c/350/100
400 A	EBH403c/400/30	EBH404c/400/30	EBH403c/400/100	EBH404c/400/100

EBL type(85kA/460V)				
Rated current, In	Rated residual current, I Δ n: 30mA		Rated residual current, I Δ n: 100/200/500mA	
	3-pole	4-pole	3-pole	4-pole
250 A	EBL403c/250/30	EBL404c/250/30	EBL403c/250/100	EBL404c/250/100
300 A	EBL403c/300/30	EBL404c/300/30	EBL403c/300/100	EBL404c/300/100
350 A	EBL403c/350/30	EBL404c/350/30	EBL403c/350/100	EBL404c/350/100
400 A	EBL403c/400/30	EBL404c/400/30	EBL403c/400/100	EBL404c/400/100

Accessories

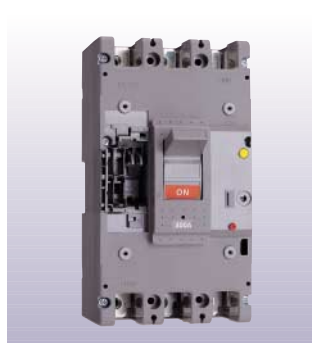

Electrical auxiliaries

AX	Auxiliary Switch
AL	Alarm Switch
SHT	Shunt Trip
UVT	Undervoltage trip

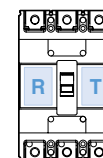

Maximum possibilities

T-position	Not available
R-position	Option of 2AX, 2AL and SHT or UVT

Note) For more detail see 73 page

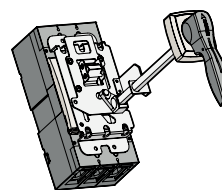

E-70U

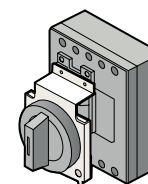

N-70

External accessories

IBL400	Insulation barrier
T1-43A	Terminal cover (Long) - 2, 3pole
T1-44A	Terminal cover (Long) - 4pole
N-70	Rotary handle (Direct)
E-70U	Rotary handle (Extended)
MI-43	Mechanical interlock - 2, 3pole
MI-44	Mechanical interlock - 4pole
X-402	Rear terminal - 2pole
X-403	Rear terminal - 3pole
X-404	Rear terminal - 4pole
PB-I3-FR	Plug-in kit

Note) For more detail see 80 page

800AF ELCB

EBN803c, EBS803c, EBL803c



EBS803c

Ratings

Frame size		800AF		
Type and Pole	3-pole(3-sensor)	N-Type	S-Type	L-Type
	4-pole(3-sensor)	EBN803c	EBS803c	EBL803c
		-	-	-
Rated current, I _n		500-630-700-800A		
Rated residual current, I _{Δn}		30, 100/200/500mA (Adjustable)		
Residual current off-time at I _{Δn}		≤0.1 sec		
Rated operational voltage, U _e		220/460V		
Rated impulse withstand voltage, U _{imp}		6 kV		
Wiring system	3-pole(3-sensor)	1 ∅ 2W, 1 ∅ 3W, 3 ∅ 3W		
	4-pole(3-sensor)	-		
Rated short-circuit breaking capacity, I_{cu}		N-Type	S-Type	L-Type
AC	415/460V	37kA	65kA	85kA
IEC 60947-2 (I _{cu})	220/250V	50kA	85kA	125kA
I _{cs} =%I _{cu}		100%	100%	75%
Protective function		Overload, Short-circuit and Ground fault		
Type of trip unit		Thermal-Magnetic		
Magnetic trip range		8~12I _n		
Endurance	Mechanical	2500 operations		
	Electrical	500 operations		
Connection	Standard	Front connection		
	Optional	Rear connection		
		Plug-in		
Mounting	Standard	Screw fixing		
Dimensions (mm)		Pole	3p	
	a		210	
	b		280	
	c1 <small>Note)</small>		109	
	c2 <small>Note)</small>		113	
	d		145	
	Weight, kg	Standard	11.5	
Certification		Pole	3p	
CE marking		-		

Note) Depth by door cut size : c1 for large cut, c2 for small cut

For more information

- Drawings ▶ 104 page
- Trip curves ▶ 90 page
- Accessories ▶ 72 page
- Connection and mounting ▶ 110 page

Ordering types

Breaker types

EBN type (37kA/460V)		
Rated current, In	Rated residual current, I Δ n: 30mA	Rated residual current, I Δ n: 100/200/500mA
	3p	3p
500 A	EBN803c/500/30	EBN803c/500/100
630 A	EBN803c/630/30	EBN803c/630/100
700 A	EBN803c/700/30	EBN803c/700/100
800 A	EBN803c/800/30	EBN803c/800/100

EBS type (65kA/460V)		
Rated current, In	Rated residual current, I Δ n: 30mA	Rated residual current, I Δ n: 100/200/500mA
	3p	3p
500 A	EBS803c/500/30	EBS803c/500/100
630 A	EBS803c/630/30	EBS803c/630/100
700 A	EBS803c/700/30	EBS803c/700/100
800 A	EBS803c/800/30	EBS803c/800/100

EBL type(85kA/460V)		
Rated current, In	Rated residual current, I Δ n: 30mA	Rated residual current, I Δ n: 100/200/500mA
	3p	3p
500 A	EBL803c/500/30	EBL803c/500/100
630 A	EBL803c/630/30	EBL803c/630/100
700 A	EBL803c/700/30	EBL803c/700/100
800 A	EBL803c/800/30	EBL803c/800/100

Accessories

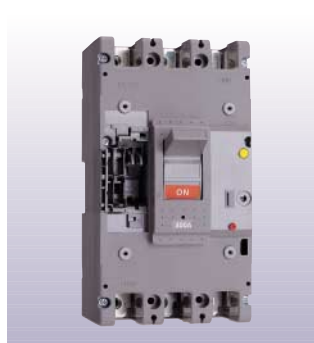

Electrical auxiliaries

AX	Auxiliary Switch
AL	Alarm Switch
SHT	Shunt Trip
UVT	Undervoltage trip

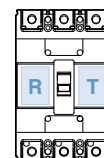

Maximum possibilities

T-position	Not available
R-position	Option of 2AX, 2AL and SHT or UVT

Note) For more detail see 73 page

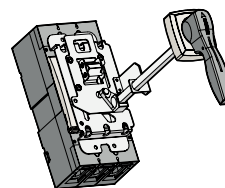

E-80U

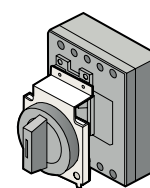

N-80

External accessories

IBL800	Insulation barrier
T1-63A	Terminal cover (Long) - 2, 3pole
T1-64A	Terminal cover (Long) - 4pole
N-80	Rotary handle (Direct)
E-80U	Rotary handle (Extended)
MI-83S	Mechanical interlock - 2, 3pole
MI-84S	Mechanical interlock - 4pole
X-802	Rear terminal - 2pole
X-803	Rear terminal - 3pole
X-804	Rear terminal - 4pole
PB-J3-FR	Plug-in kit

Note) For more detail see 80 page

1000/1200AF ELCB

EBS1003b, EBS1203b

Metasol



Ratings

Frame size	1000AF	1200AF		
Type and Pole	S-Type			
	3-pole(3-sensor)	EBS1003b	EBS1203b	
	4-pole(4-sensor)	-	-	
Rated current, I _n	1000A			
Rated residual current, I _{Δn}	100/200/500mA (Adjustable)			
Residual current off-time at I _{Δn}	≤0.1 sec			
Rated operational voltage, U _e	AC: 460V			
Wiring system	3-pole(3-sensor) 1Ø2W, 1Ø3W, 3Ø3W			
Rated short-circuit breaking				
		S-Type	S-Type	
capacity, I _{cu}	AC 415/460V	85kA		
IEC 60947-2 (I _{cu})	220/250V	125kA		
Protective function			Overload, Short-circuit and Ground fault	
Type of trip unit	Thermal-Magnetic			
Magnetic trip range	3-6 × I _n			
Endurance	Mechanical	2500operations		
	Electrical	500operations		
Connection	Standard	Front connection		
Mounting	Standard	Screw fixing		
Dimensions (mm)			Pole	
			3p	
			a	220
			b	565
			c	105
			d	159
Weight, kg	Standard	27.1		

For more information

- Drawings ▶ 105 page
- Trip curves ▶ 91 page

Ordering types

Breaker types

EBS type (85kA/460V)	
Rated current, In	3p
1000 A	EBS1003b/1000/100
1200 A	EBS1203b/1200/100

Option of below items for T-position

AX1	Auxiliary Switch (1c)
AL1	Alarm Switch (1c)
AX1+AL1	Auxiliary (1c) + Alarm (1c) Switch

Note) R-position is not available.

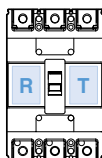

Contact operation for Auxiliary and Alarm Switches

MCCB	ON	OFF	TRIP
AX			
AL			

Contact rating for Auxiliary and Alarm Switches

Voltage (V)	AC		Voltage (V)	DC	
	Current (A)			Current (A)	
	Resistive load	Inductive load		Resistive load	Inductive load
125	20	20	30	6	5
250	20	20	125	0.4	0.05
500	10	5	250	0.2	0.03

Electrical auxiliaries of 30~250AF

Option of connecting AX or AL or AX+AL
This seat is not available for 2-pole breakers.

Option of connecting SHT or UVT or AX or AL or AX+AL
This seat is not available for ELCB.

Maximum possibilities

Position	Type	ABN100c		ABH125c		ABH250c	EBN100c	EBH125c	EBH250c
		2p	3/4p	2p	3/4p	2/3/4p	2/3/4p	3/4p	2/3/4p
Left-hand seat	AX	-	1	-	1	1	1	1	1
	AL	-	1	-	1	1	1	1	1
	AX+AL	-	1	-	1	1	1	1	1
Right-hand seat	AX	1	1	1	1	1	-	-	-
	AL	1	1	1	1	1	-	-	-
	AX+AL	1	1	1	1	1	-	-	-
	SHT/UVT	1	1	1	1	1	-	-	-

Electrical auxiliaries of 400~800AF

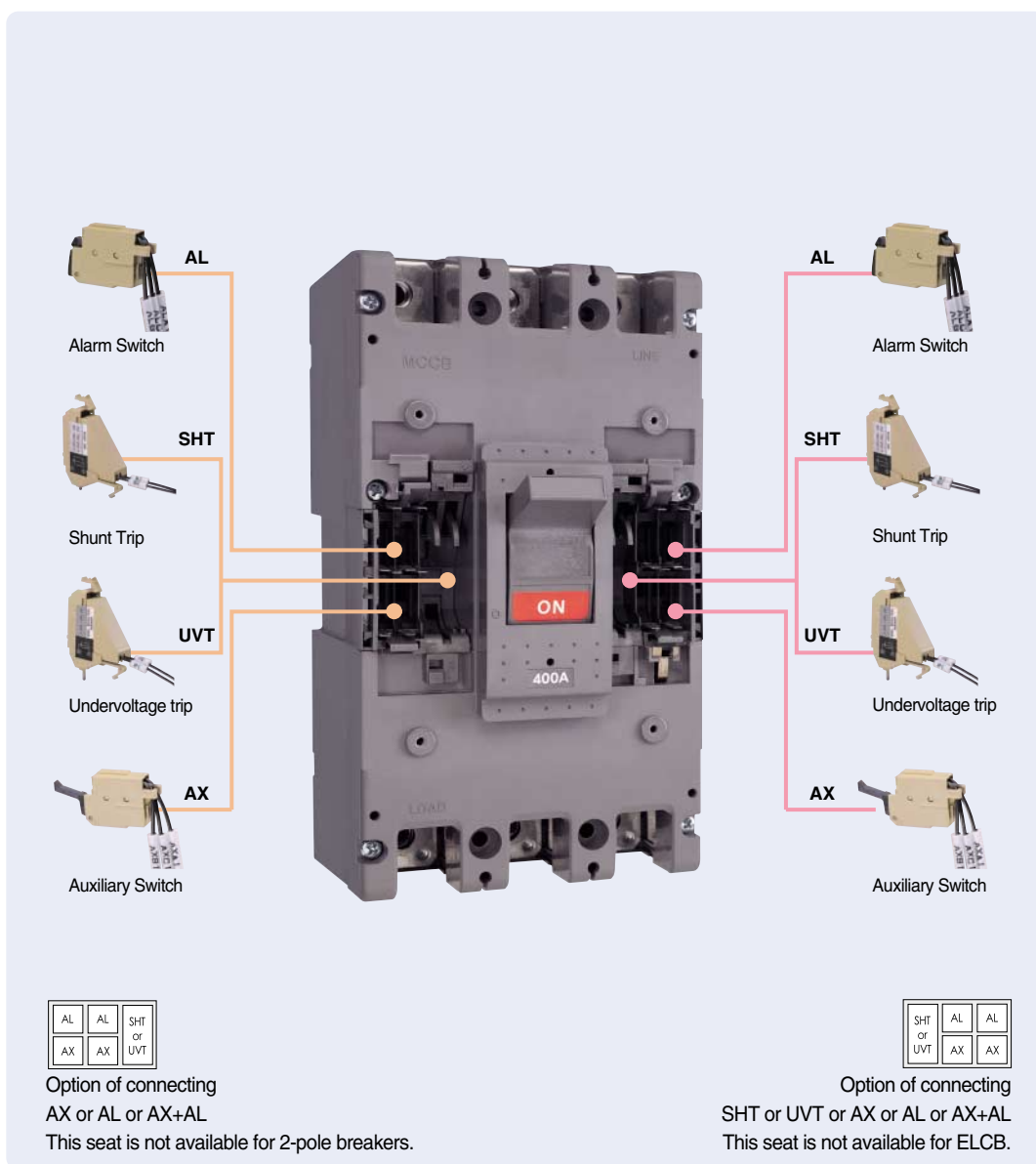

Maximum possibilities

Position	Type	MCCB (400~800AF)	ELCB (400~800AF)
Left-hand seat	AX	2	2
	AL	2	2
	SHT/UVT	1	1
Right-hand seat	AX	2	-
	AL	2	-
	SHT/UVT	1	-

Accessories

Combinations of accessories

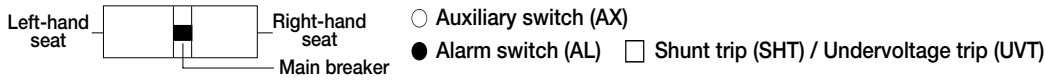

Series		MCCB (30-250AF)				MCCB (400-800AF)	MCCB (1000-1200AF)
Type	N-Type	ABE 32b	ABE 33b	ABN 52c ABN 62c ABN 102c/102d	ABN 53c/54c ABN 63c/64c ABN 103c/104c, ABN 103d/104d ABN 202c/203c/204c	ABN 402c/403c/404c ABN 602c/603c/604c ABN 802c/803c/804c	-
	S-Type	-	-	ABS 32c ABS 52c ABS 62c ABS 102c	ABS 33c/34c ABS 53c/54c ABS 63c/64c ABS 103c/104c ABS 202c/203c/204c	ABS 402c/403c/404c ABS 602c/603c/604c ABS 802c/803c/804c	ABS 1003b ABS 1004b ABS 1203b ABS 1204b ABS 1203bE
	H-Type	-	-	ABH 52c ABH 102c	ABH 53c/54c ABH 103c/104c ABH202c/203c/204c	ABH 402c/403c/404c	-
	L-Type	-	-	-	-	ABL 402c/403c/404c ABL 602c/603c/604c ABL 802c/803c/804c	ABL 1003b ABL 1004b ABL 1203b ABL 1204b
Pole	2 Pole	3 Pole	2 Pole	2, 3, 4 Pole		2, 3, 4 Pole	3, 4 Pole
AX							
AX2							
AX3 (4)							
AL							
AL2							
AL3(4)							
SHT(UVT)							
SHT(UVT)2							
AX+AL							
AX+AL2							
AX+AL3(4)							
AX2+AL							
AX2+AL2							
AX2+AL3(4)							
AX3(4)+AL							
AX3(4)+AL2							
AX3(4)+AL3(4)							
AX+SHT(UVT)							

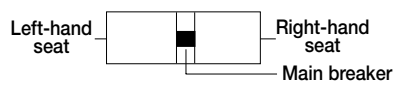

- Auxiliary switch (AX)
- Alarm switch (AL) □ Shunt trip (SHT) / Undervoltage trip (UVT)

Series	MCCB (30-250AF)				MCCB (400-800AF)	MCCB (1000-1200AF)	
Type	N-Type	ABE 32b	ABE 33b	ABN 52c ABN 62c ABN 102c	ABN 53c/54c ABN 63c/64c ABN 103c/104c ABN 202c/203c/204c	ABN 402c/403c/404c ABN 602c/603c/604c ABN 802c/803c/804c	-
	S-Type	-	-	ABS 32c ABS 52c ABS 62c ABS 102c	ABS 33c/34c ABS 53c/54c ABS 63c/64c ABS 103c/104c ABS 202c/203c/204c	ABS 402c/403c/404c ABS 602c/603c/604c ABS 802c/803c/804c	ABS 1003b ABS 1004b ABS 1203b ABS 1204b ABS 1203bE
	H-Type	-	-	ABH 52c ABH 102c	ABH 53c/54c ABH 103c/104c ABH202c/203c/204c	ABH 402c/403c/404c	-
	L-Type	-	-	-	-	ABL 402c/403c/404c ABL 602c/603c/604c ABL 802c/803c/804c	ABL 1003b ABL 1004b ABL 1203b ABL 1204b
Pole	2 Pole	3 Pole	2 Pole	2, 3, 4 Pole	2, 3, 4 Pole	3, 4 Pole	
AX+SHT(UVT)2							
AX2+SHT(UVT)							
AX2+SHT(UVT)2							
AX3(4)+SHT(UVT)							
AX3(4)+SHT(UVT)2							
AL+SHT(UVT)							
AL+SHT(UVT)2							
AL2+SHT(UVT)							
AL2+SHT(UVT)2							
AL3(4)+SHT(UVT)							
AL3(4)+SHT(UVT)2							
AX+AL+SHT(UVT)							
AX+AL+SHT(UVT)2							
AX2+AL2+SHT(UVT)							
AX2+AL2+SHT(UVT)2							
AX3(4)+AL3(4)+SHT(UVT)							
AX3(4)+AL3(4)+SHT(UVT)2							

Combinations of accessories

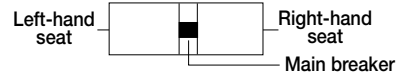

- Auxiliary switch (AX)
- Alarm switch (AL) □ Shunt trip (SHT) / Undervoltage trip (UVT)

Series		ELCB (30-250AF)	ELCB (400-800AF)	ELCB (1000-1200AF)
Type	N-Type	EBN 52c/53c/54c EBN 63c EBN 102c/103c/104c EBN 202c/203c	EBN 403c/404c EBN 603c EBN 803c	-
	S-Type	EBS 33c/34c EBS 53c/54c EBS 63c/64c EBS 103c/104c EBS 203c/204c	EBS 403c/404c EBS 603c ABS 803c	EBS 1003b EBS 1203b
	H-Type	EBH 53c/54c EBH 53c/54c EBH 103c/104c	EBH 403c/404c	-
	L-Type	-	EBL 403c/404c EBL 603c EBL 803c	-
Pole		3, 4 Pole	3 Pole	3 Pole
AX				
AX2				
AL				
AL2				
SHT(UVT)				
AX+AL				
AX+AL2				
AX2+AL				
AX2+AL2				
AX+SHT(UVT)				
AX2+SHT(UVT)				
AL+SHT(UVT)				
AL2+SHT(UVT)				
AX+AL+SHT(UVT)				
AX2+AL2+SHT(UVT)				

Terminal block type

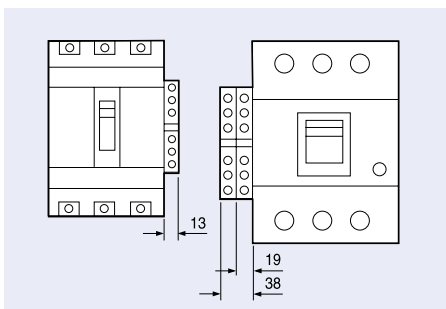

Auxiliary and Alarm switch

Auxiliary switch (AX)



Auxiliary switch is for applications requiring remote “ON” and “OFF” indication. Each switch contains two contacts having a common connection. One is open and the other closed when the circuit breaker is open, and viceversa.

Alarm switch (AL)



Alarm switches offer provisions for immediate audio or visual indication of a tripped breaker due to overload, short circuit, shunt trip, or undervoltage release conditions.

They are particularly useful in automated plants where operators must be signaled about changes in the electrical distribution system. This switch features a closed contact when the circuit breaker is tripped automatically. In other words, this switch does not function when the breaker is operated manually. Its contact is open when the circuit breaker is reset.

Combination switch (AX+AL)

It consists of one auxiliary switch (AX) and one alarm switch (AL) in a body to connect into the same position of the breaker.

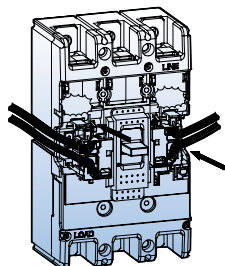

Contact (AX+AL)

MCCB	ON	OFF	TRIP
AX			
AL			

Rating (AX+AL)

Conventional thermal current, I _{th}	5A		
Rated operational current, I _e	Voltage, U _e	Current, I _e	
		Resistive load	Inductive load
AC 50/60Hz	125V	5	3
	250V	3	2
	500V	-	-
DC	30V	4	3
	125V	0.4	0.4
	250V	0.2	0.2

Shunt trip, SHT

The shunt trip opens the mechanism in response to an externally applied voltage signal. The releases include coil clearing contacts that automatically clear the signal circuit when the breaker has tripped. This is not available for ELCBs of 30~250AF .

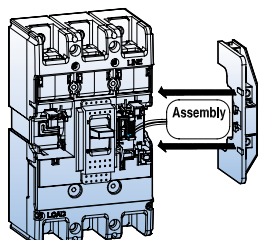

Rating for 30~250AF



Control voltage, Ue	Power consumption		
	AC (VA)	DC (W)	mA
AC/DC 12V	0.35	0.36	30
AC/DC 24V	0.64	0.65	27
AC/DC 48V	1.09	1.1	23
AC/DC 60V	1.2	1.22	20
AC/DC 100~130V	0.73	0.75	5.8
AC/DC 200~250V	1.21	1.35	5.4
AC 380~450V	1.67	-	3.8
AC 440~500V	1.68	-	3.5
Max. opening time	50ms (max.)		
Tightening torque of terminal screw	12 kgf · cm		

Note:
 - Range of operational voltage: 0.7 ~ 1.1Vn
 - Frequency (Only AC): 45Hz ~ 65Hz

Rating for 400~800AF



Control voltage, Ue	Power consumption		
	V	mA	W
AC/DC 24~48	AC 24	14	0.3
AC 100~125/DC 100~110	DC 24	15.4	0.4
AC 200~240/DC 200~220	AC 48	14	0.7
AC 380~460	DC 48	16	0.8
AC 480~550	AC 110	6	0.7
	DC 110	6.6	0.7
	AC 220	6.8	1.5
	DC 200	7.6	1.5
	AC 440	4.3	1.9
	AC 480	4.4	3.3
	AC 550	4.6	2.4

Note: Range of operational voltage
 AC: 0.85 ~ 1.1Vn
 DC: 0.75 ~ 1.25Vn

Undervoltage release, UVT

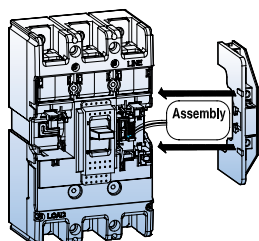

The undervoltage release automatically opens a circuit breaker when voltage drops to a value ranging between 20% to 70% of the line voltage. The operation is instantaneous, and after tripping, the circuit breaker cannot be re-closed again until the voltage returns to 85% of line voltage.

Continuously energized, the undervoltage release must be operating before the circuit breaker can be closed. This is not available for ELCBs of 30~250AF.

- Range of tripping voltage: 0.2 ~ 0.7Vn
- Reset and closing of a breaker is possible when the control voltage is over 0.85Vn
- Frequency (Only AC): 45Hz ~ 65Hz

Rating for 30~250AF



Control voltage, Ue	Power consumption		
	AC (VA)	DC (W)	mA
AC/DC 24V	0.64	0.65	27
AC/DC 48V	1.09	1.1	23
AC/DC 100~110V	0.73	0.75	5.8
AC/DC 200~220V	1.21	1.35	5.4
AC 380~440V	1.67	-	3.8
AC 440~480V	1.68	-	3.5
Max. opening time	50ms (max.)		
Tightening torque of terminal screw	12 kgf · cm		
Operating voltage range	Trip	20~70% Vn	
	Reset/Closing	≥ 0.85Vn	

Rating for 400~800AF



Control voltage, Ue	Trip voltage	Reset/closing voltage	Time rating
AC/DC 48	· AC: 85~1.1Vn · DC: 85~1.25Vn	· AC: 0.2~0.7Vn · DC: 0.2~0.7Vn	Continuous
AC/DC 100~125			
AC/DC 200~240			
AC 380~440			
AC 440~480			

Terminal numbering

Auxiliary Switch (AX)	Alarm Switch (AL)	Shunt Trip (SHT)	Undervoltage trip (UVT)

External accessories

Wide range of external accessories provides user-friendly solution for mounting, cable connection, insulation, safety lock and remote control.

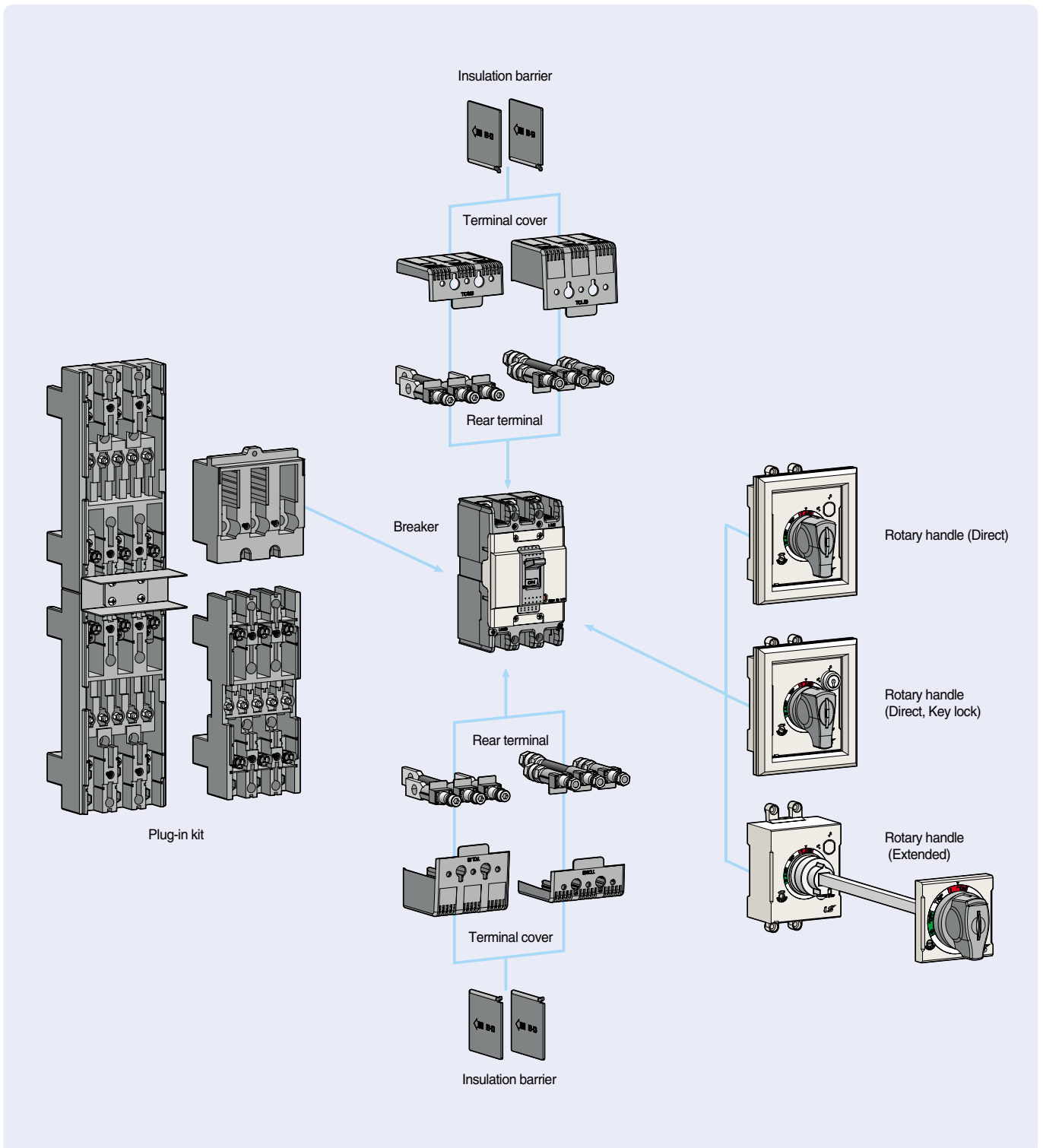

Rotary handles

Direct type



Direct type

The rotary handle operating mechanism is available in either the direct version or in the extended version on the compartment door. It is always fitted with a compartment door lock and on a request it can be supplied with a key lock in the open position.

Type

Direct type	Direct type (Key lock)	Extended type	Breaker type	
			MCCB	ELCB
DH100	DHK100	EH100	ABN50c/60c/100c ABS30c/50c/60c	EBN50c/60c/100c EBS30c/50c/60c
DH125	DHK125	EH125	ABS125c ABH50c/125c	EBS125c EBH50c/125c
DH250	DHK250	EH250	ABN250c, ABS250c ABH250c	EBN250c, EBS250c EBH250c
N-70	-	E-70U	ABN/S/H/L400c	EBN/S/H/L400c
N-80	-	E-80U	ABN/S/L800c	EBN/S/L800c



Key lock
(30~250AF)

Degree of protections

Type	Degree of protection	IP degree
Circuit breaker with cover frame and rotary direct handle	The access probe of 1.0mm diameter shall not penetrate.	IP40
Circuit breaker with cover frame and rotary extended handle	Totally protected against ingress of dust and water jets from any direction	IP65

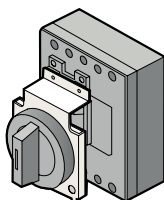

(400~800AF)

Extended type



Extended type
(30~250AF)

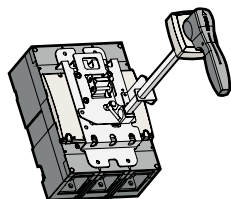

(400~800AF)

Type suffix according to the mounting position

S-Type

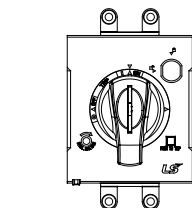
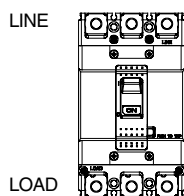

L-Type

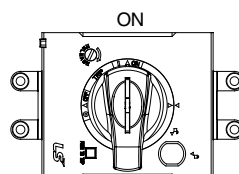
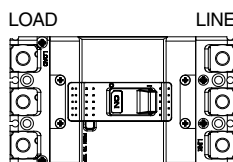

R-Type

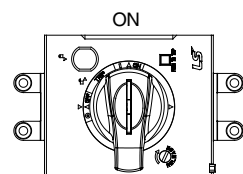
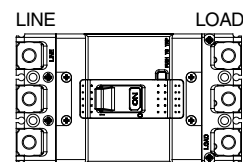

Terminal covers

The terminal covers are applied to the circuit-breaker to prevent accidental contact with live parts and thereby guarantee protection against direct contacts.

Two types by length are available and provide IP40 degree of protection.



TCS (Short type)

- **Short type covers, TCS:**

For fixed circuit-breakers with rear terminals and for moving parts of plug-in.

- **Long type covers, TCL:**

For fixed circuit-breakers with front, front extended, front for cables terminals.



TCL (Long type)

Type		Pole	Breaker	
Short Type	Long Type		MCCB	ELCB
TBS22	-	2P	ABE30b	-
TBS23	-	3P		
TCS12	TCL12	2P	ABN50c/60c/100c	EBN50c/60c/100c
TCS13	TCL13	3P		
TCS14L	TCL14L	4P Line	ABS30c/50c/60c	EBS30c/50c/60c
TCS14R	TCL14R	4P Load		
TCS22	TCL22	2P	ABS125c	EBS125c
TCS23	TCL23	3P		
TCS24L	TCL24L	4P Line	ABH50c/125c	EBH50c/125c
TCS24R	TCL24R	4P Load		
TCS33	TCL33	2/3P	ABN250c, ABS250c	EBN250c, EBS250c
TCS34L	TCL34L	4P Line		
TCS34R	TCL34R	4P Load	ABH250c	EBH250c
-	T1-43A	2, 3P		
-	T1-44A	4P	ABN/S/H/L400c	EBN/S/H/L400c
-	T1-63A	2, 3P		
-	T1-64A	4P	ABN/S/L800c	EBN/S/L800c

Note: Terminal covers for 400AF and 800AF MCCBs are in acrylic.



Short type construction



Long type construction

Insulation barriers



Insulation barrier allows the insulation characteristics between the phases at the connections to be increased. They are mounted from the front, even with the circuit-breaker already installed, inserting them into the corresponding slots.

They are incompatible with both the insulating terminal covers.

It is possible to mount the phase separating partitions between two circuit-breakers side by side.

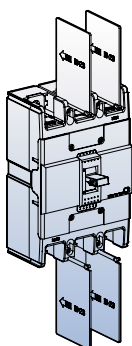

Type	Breaker	
	MCCB	ELCB
IB-13	ABN50c/60c/100c	EBN50c/60c/100c
	ABS30c/50c/60c	EBS30c/50c/60c
IB-23	ABS125c	EBS125c
	ABH50c/125c	EBH50c/125c
	ABN250c, ABS250c	EBN250c, EBS250c
	ABH250c	EBH250c
IBL400	ABN/S/H/L400c	EBN/S/H/L400c
IBL800	ABN/S/L800c	EBN/S/L800c



Insulation barriers for line side are provided as standard.

Rear connection terminals

Rear connection terminals are used to adapt the circuit breakers to switchboards or other applications that require rear connection.

There are two kinds of rear connection terminals.

- Flat type
- Round type

Round type terminals



Breaker	For 2-pole	For 3-pole	For 4-pole
ABN100c 50AF	RTR1-52	RTR1-53	-
ABN100c 100AF	RTR1-102	RTR1-103	RTR1-104
ABH125c	RTR2-102	RTR2-103	RTR2-104
ABH250c	RTR3-202	RTR3-203	RTR3-204

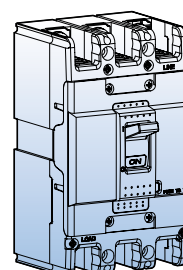
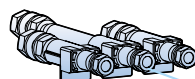
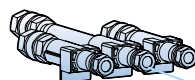
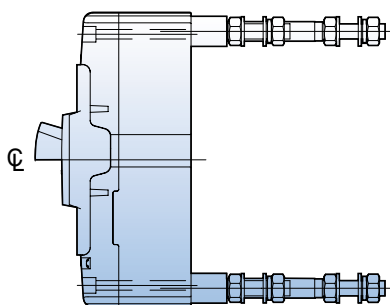

Flat type terminals



Breaker	For 2-pole	For 3-pole	For 4-pole
ABN100c	RTB1-102	RTB1-103	RTB1-104
ABH125c	RTB2-102	RTB2-103	RTB2-104
ABH250c	RTB3-202	RTB3-203	RTB3-204
AB□400c	X-402	X-403	X-404
AB□800c	X-802	X-803	X-804

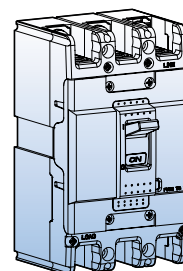
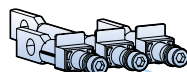
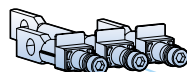
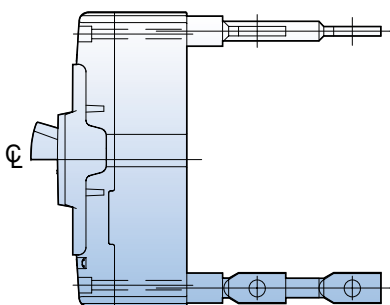

Plug-in devices



Plug-in base

Plug-in device makes it possible to extract and/or rapidly replace the circuit breaker without having to touch connections for ship and important installations.

The plug-in base is the fixed part of the plug-in version of the circuit-breaker.

It will be installed directly on the back plate of panel.

The circuit-breaker is racked out by unscrewing the top and bottom fixing screws.

Normal type Plug-in MCCB

- MCCB current rating upto 250A
- generally used in switchgears

Double-row type Plug-in MCCB

- For 125AF MCCB
- generally used in branch circuits

Type names of blocks

Breaker	Arrangement	P lug-in block	Remark
ABN100c	Normal	PB-A3-FR	
	Single-row	PB-A3-1DB	
	Double-row	PB-A3-2DB	
	Line-only	PB-A3-FRL	
ABH125c	Normal	PB-C3-FR	
	Single-row	PB-C3-1DB	
	Double-row	PB-C3-2DB	
	Line-only	PB-C3-FRL	
ABH250c	Normal	PB-D3-FR	
400AF	Normal/Line-only	PB-I3-FR/PB-I3-FRL	
800AF	Normal	PB-J3-FR	

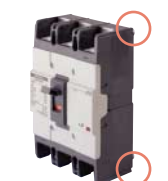

Plug-in type MCCB (plug-in terminal built)



ABH103c plug-in type



ABH203c plug-in type

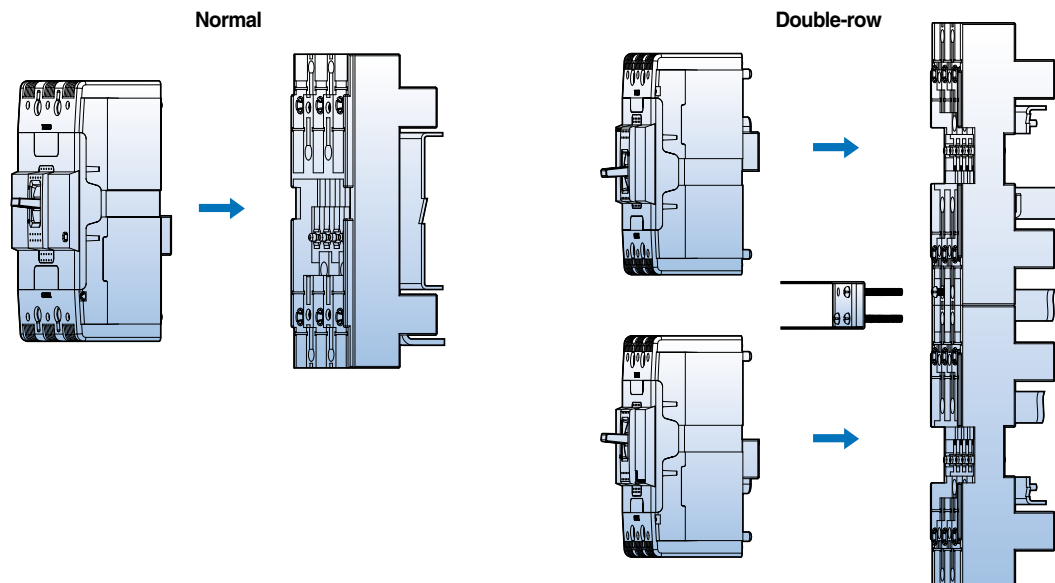

Characteristics curves

Breaker types

MCCB
ABE30b

Compensation curves

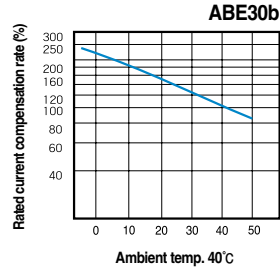

Rated current: 3~30A (ABE)

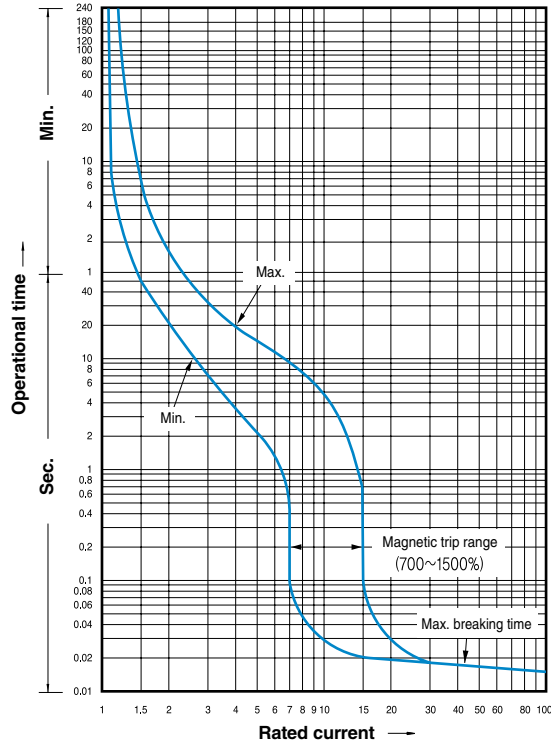

Breaker types

MCCB
ABN50c/60c/100c/100d
ABS30c/50c/60c
ELCB
EBN50c/60c/100c
EBS30c/50c/60c

Compensation curves

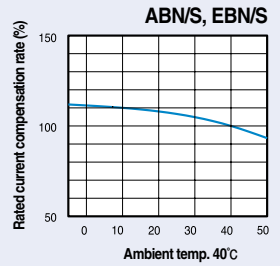

Rated current: 3~30A (ABN/S,EBN/S)

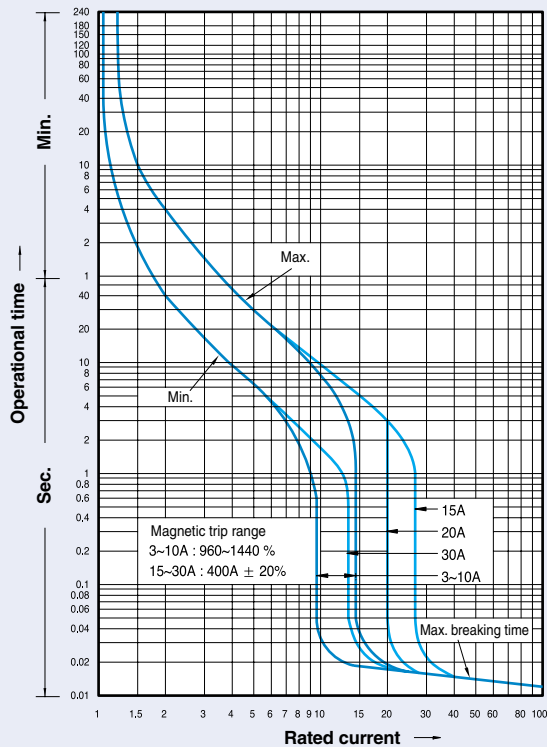

Rated current: 40~100A (ABN/S,EBN/S)

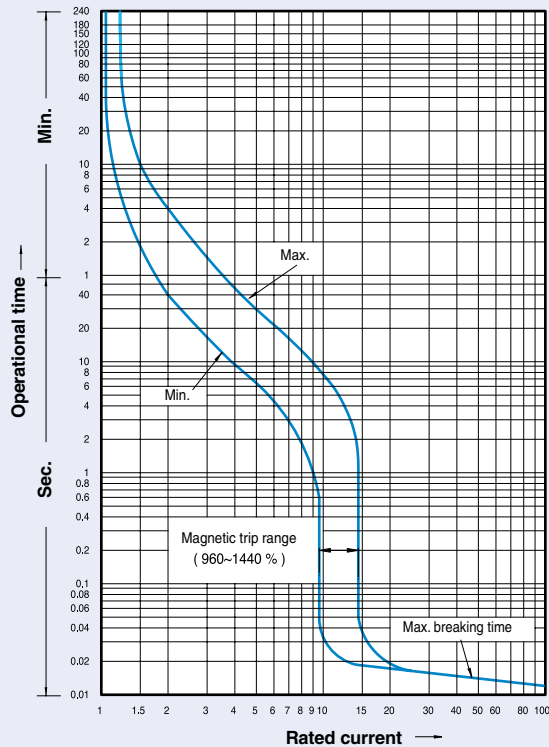

Characteristics curves

Breaker types

MCCB
ABS125c
ABH50c/125c
ELCB
EBS125c
EBH50c/125c

Rated current: 15~30A, 40~100A

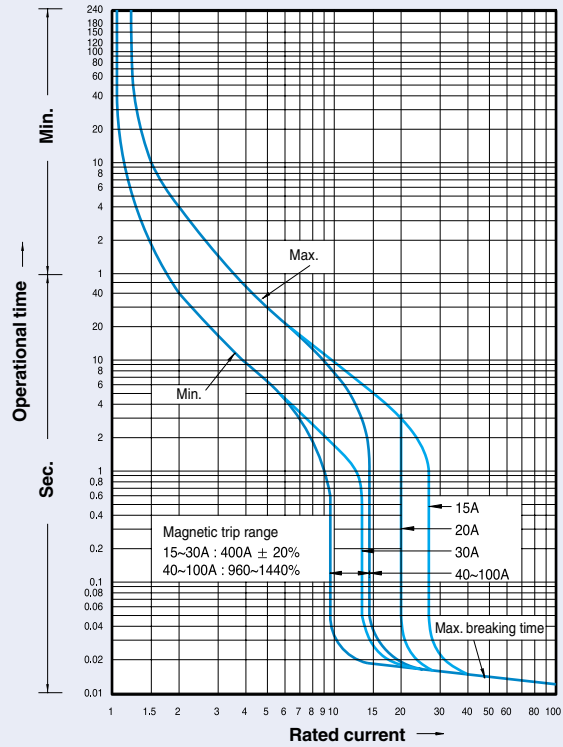

Compensation curves

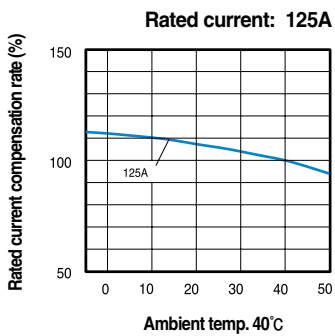
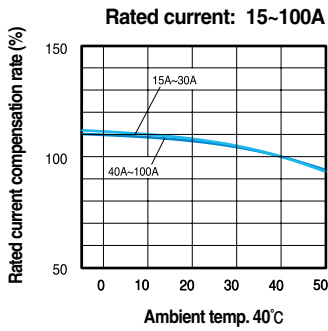

Rated current: 125A

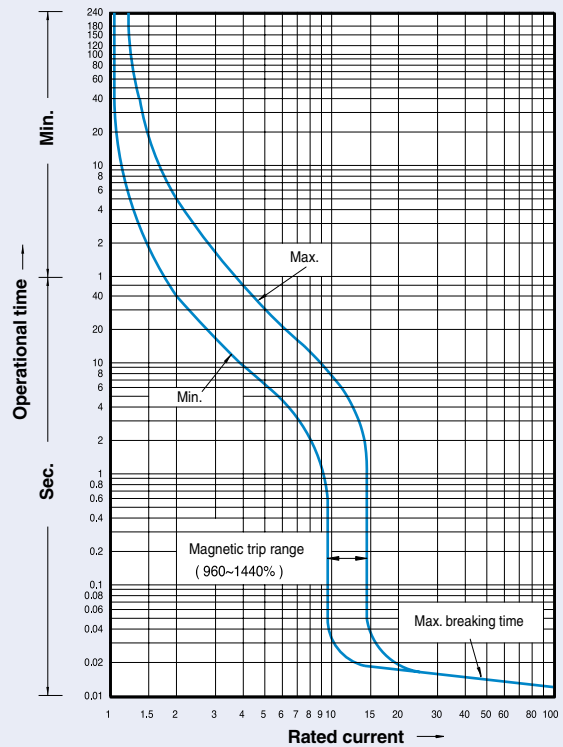

Breaker types

MCCB
ABN250c, ABS250c
ABH250c
ELCB
EBN250c, EBS250c
EBH250c

Rated current: 100~225A

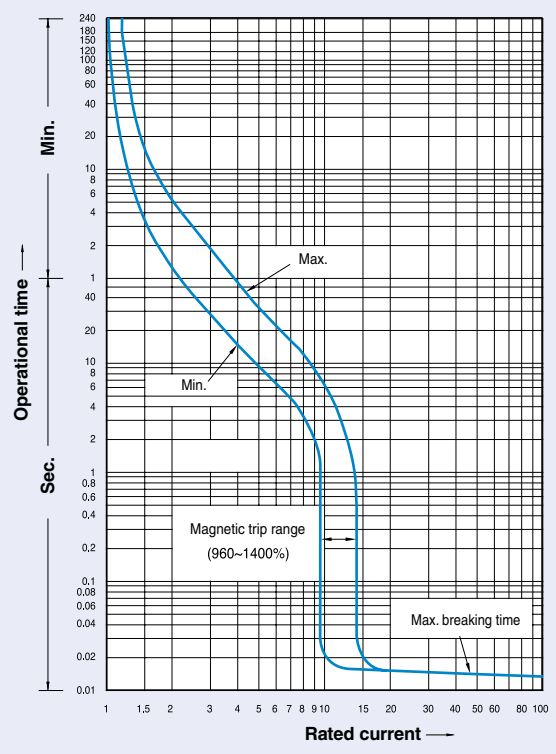

Compensation curves

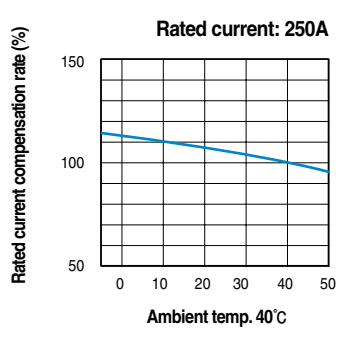
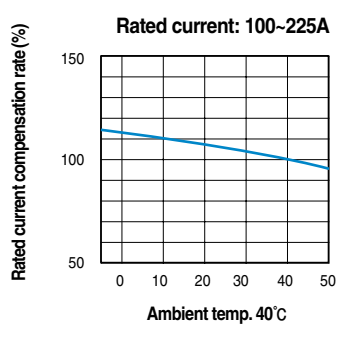

Rated current: 250A

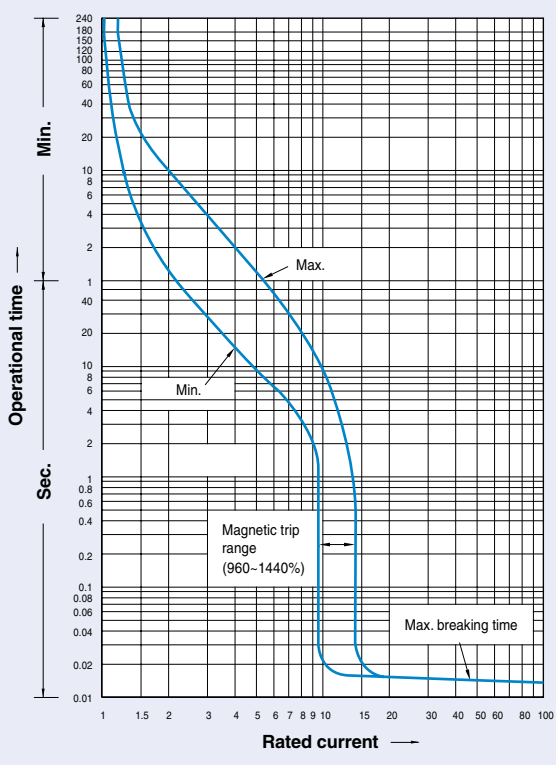

Characteristics curves

Breaker types

MCCB
ABN400c, ABS400c, ABH400c, ABL400c
ABN800c, ABS800c, ABL800c
ELCB
EBN400c, EBS400c, EBH400c, EBL400c
EBN800c, EBS800c, EBL800c

Rated current: 250~400A

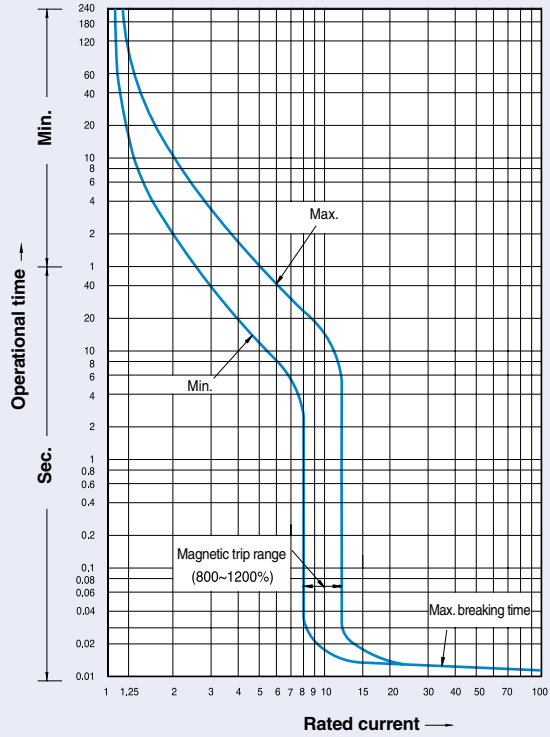

Compensation curves

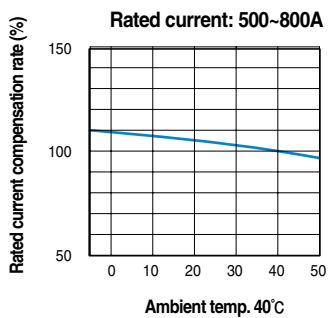
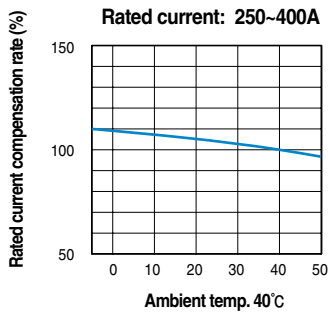

Rated current: 500~800A

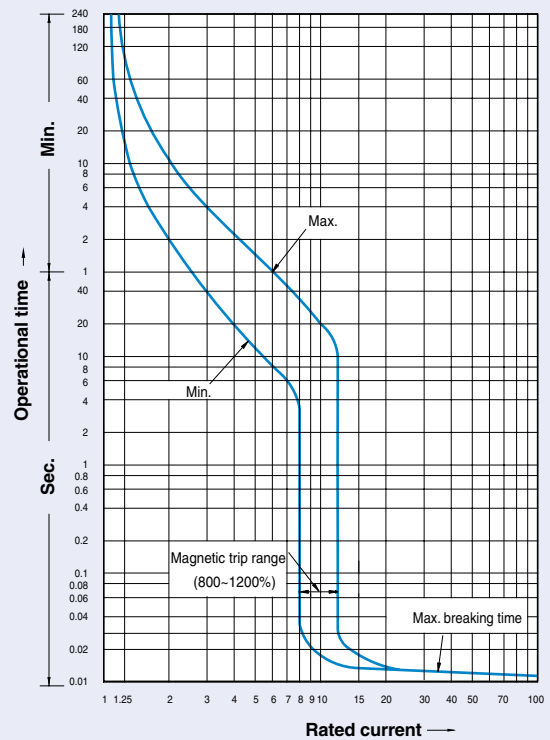

Breaker types

MCCB
ABS1000b, ABL1000b
ABS1200b, ABL1200b
ELCB
EBS1003b, EBS1203b

Compensation curves

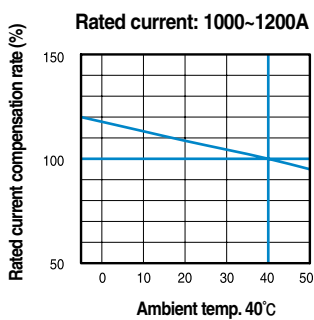

Breaker types

MCCB
ABS1200bE

Rated current: 1000~1200A

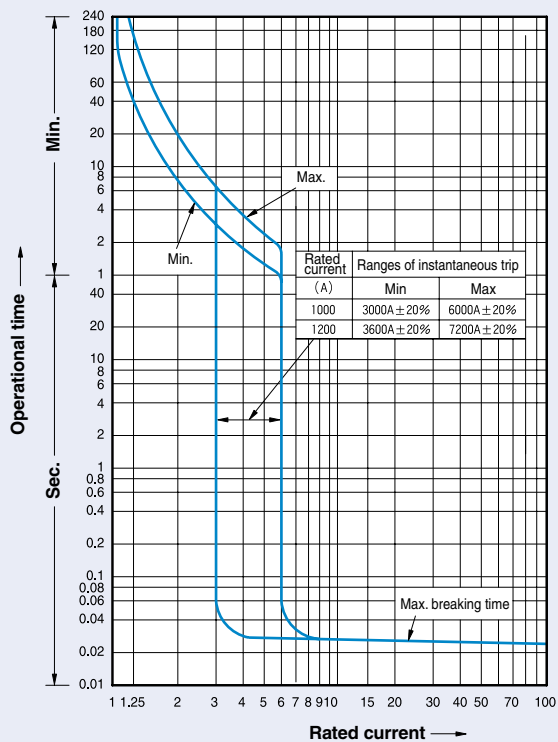

Rated current: 1200A

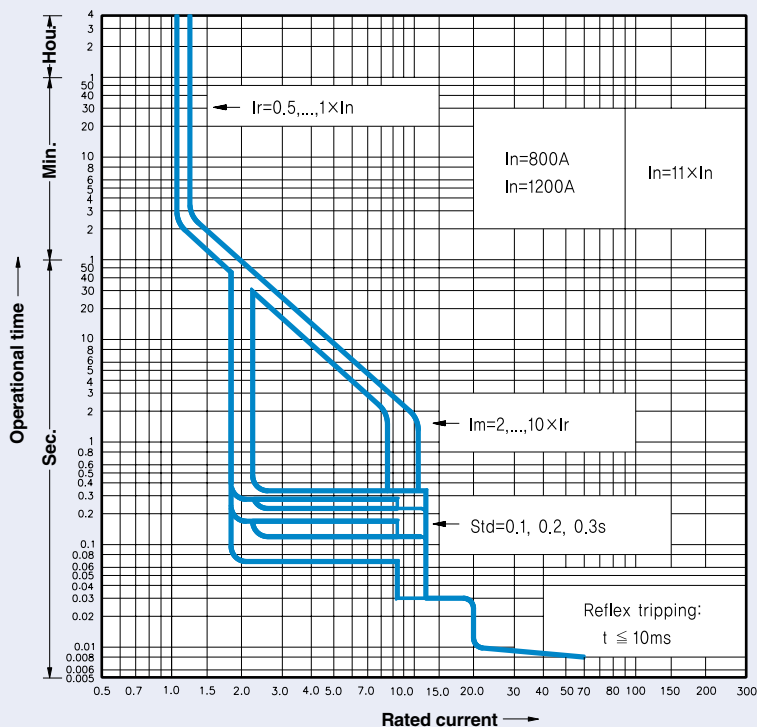

Dimensions

MCCB

ABE30b

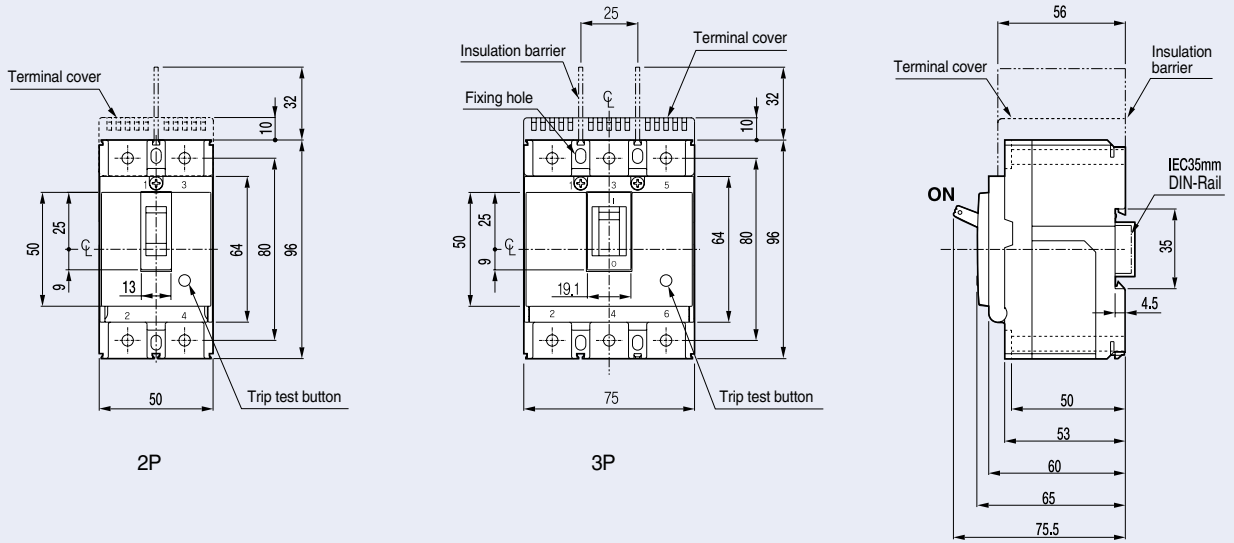

Terminal details

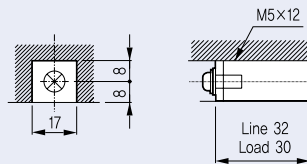

Panel drilling

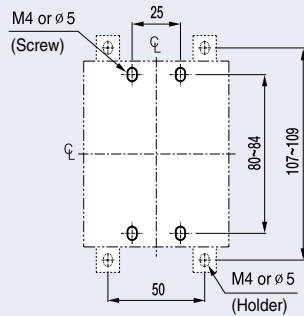
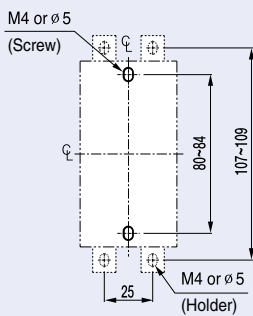

Front panel cutting

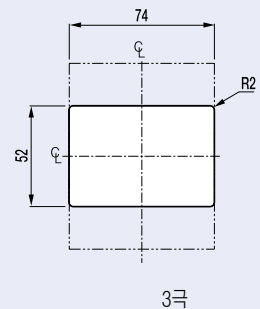
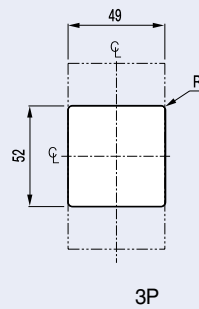

MCCB

ABN50c	ABS30c
ABN60c	ABS50c
ABN100c	ABS60c

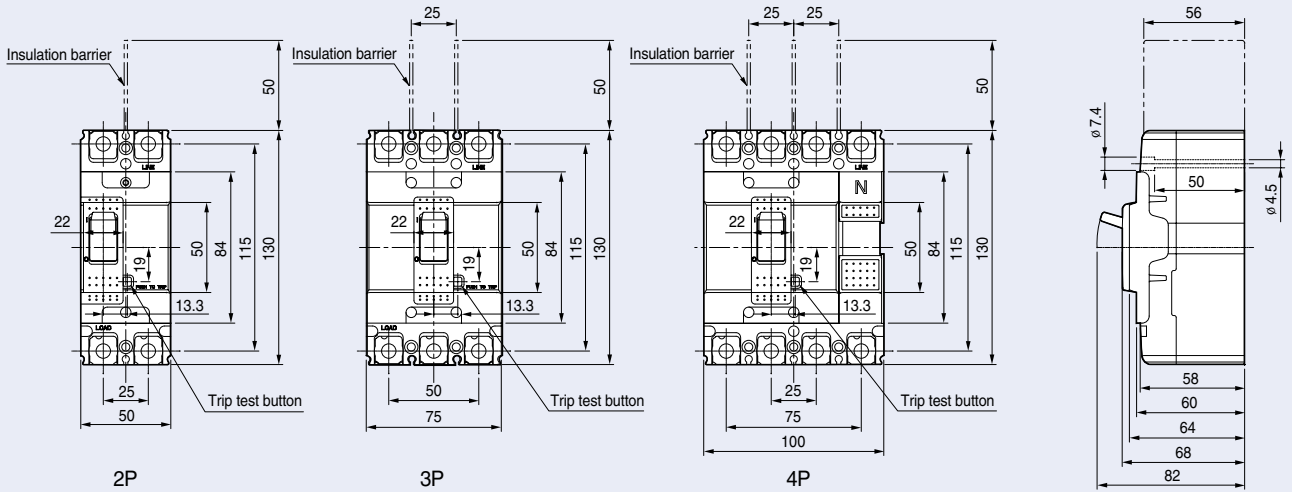

Terminal details

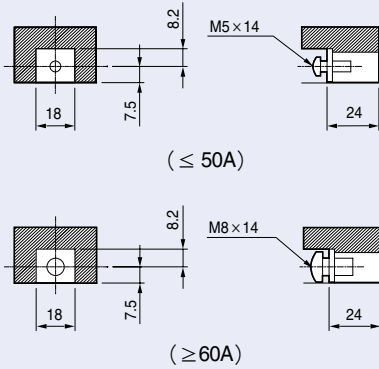

Connecting

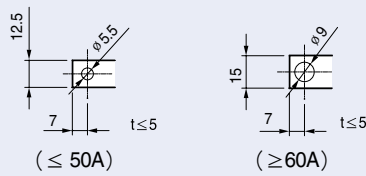

Panel drilling

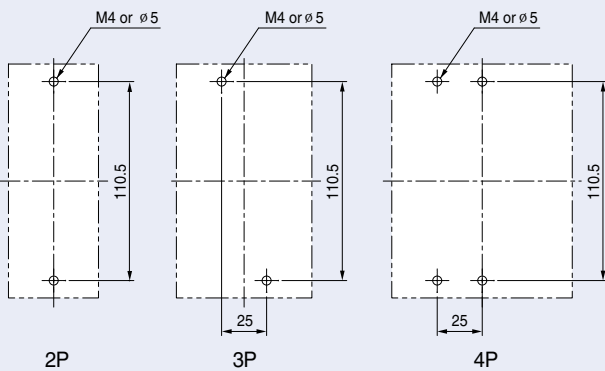

Front panel cutting

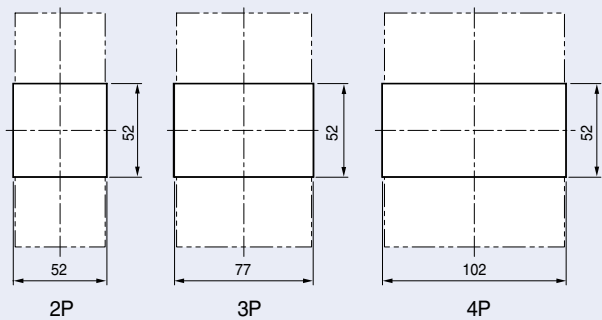

Dimensions

MCCB

ABS125c

ABH50c

ABH125c

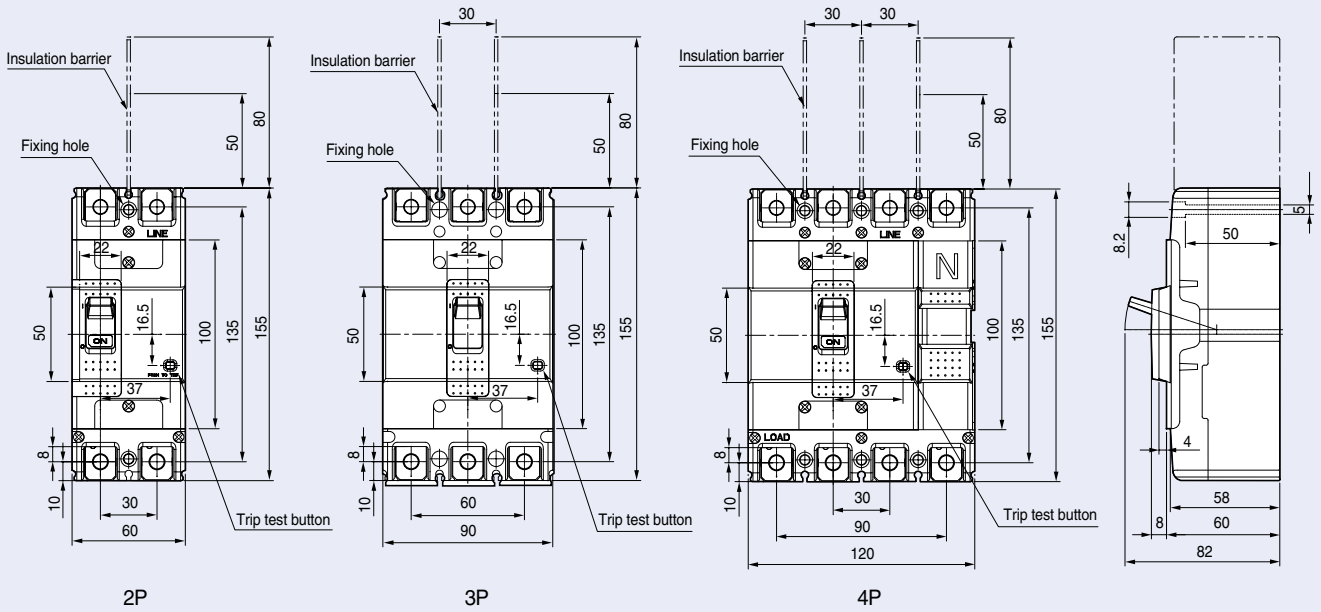

Terminal details

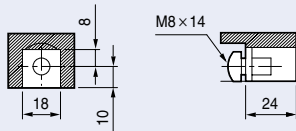

Connecting

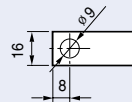

Panel drilling

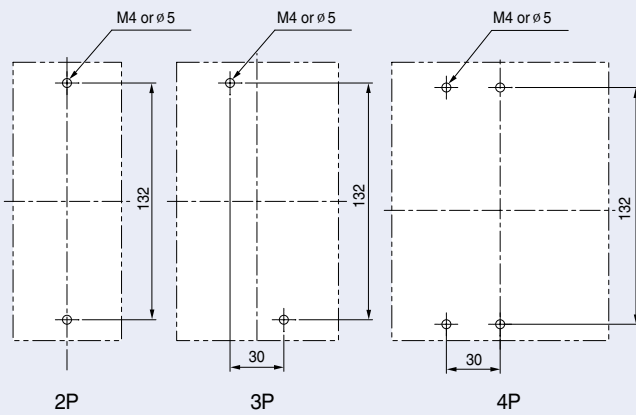

Front panel cutting

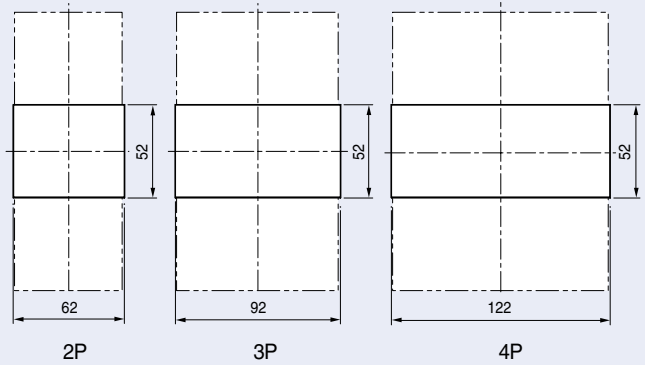

MCCB

ABN250c

ABS250c

ABH250c

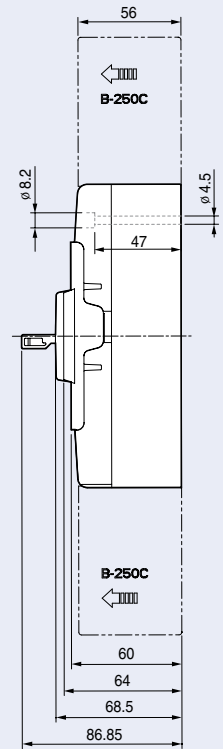
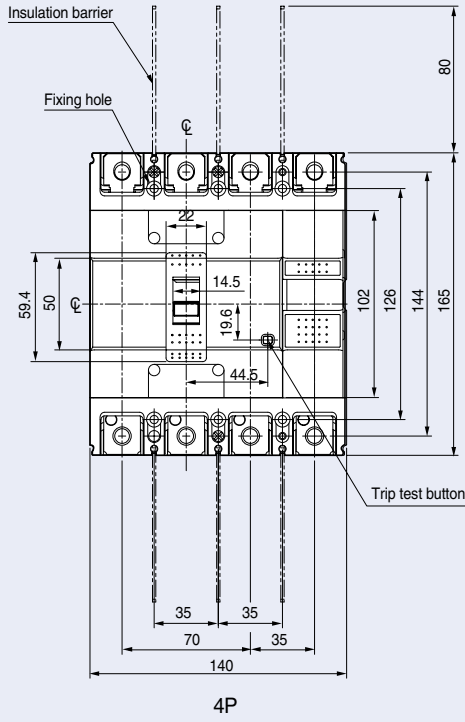
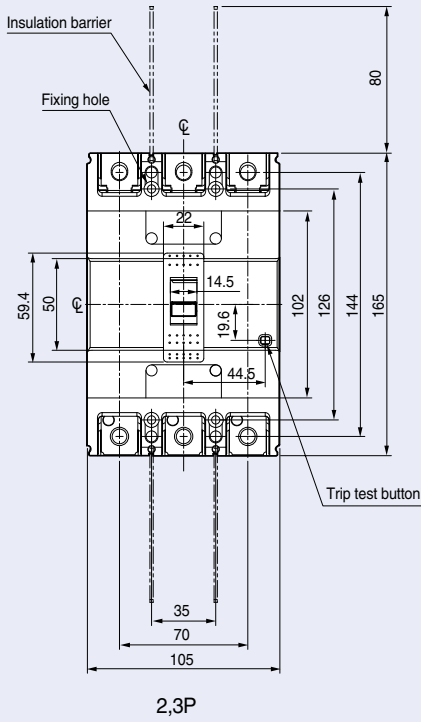

Terminal details

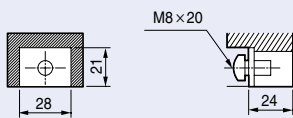

Connecting

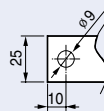

Panel drilling

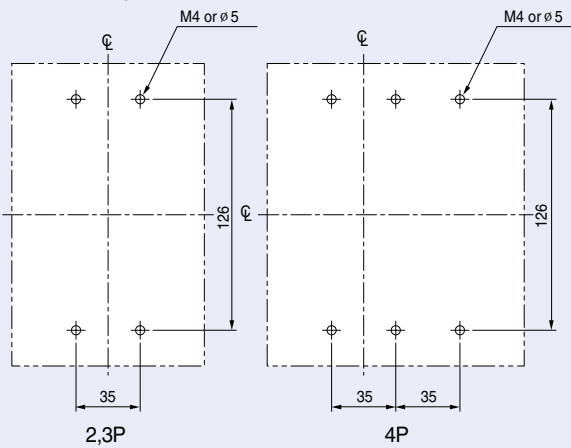

Front panel cutting

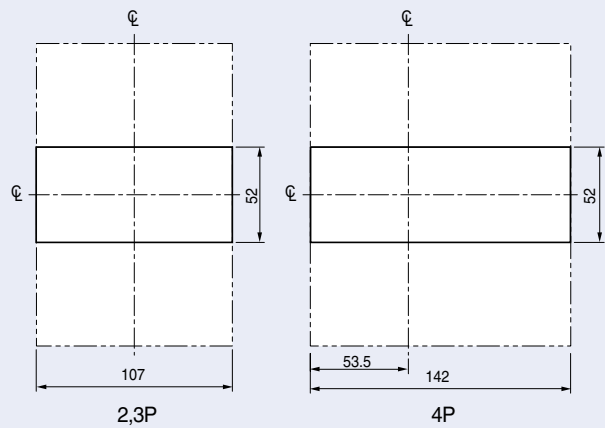

Dimensions

MCCB

- ABN400c
- ABS400c
- ABH400c
- ABL400c

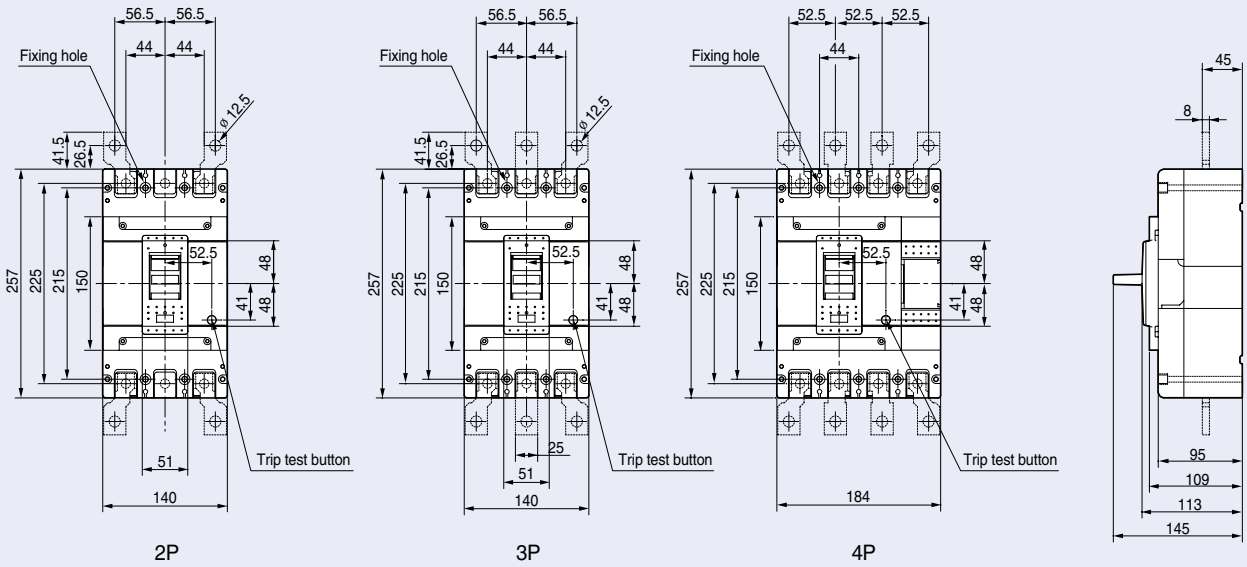

Terminal details

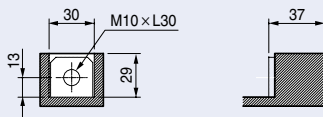

Connecting

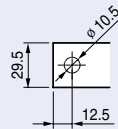

Panel drilling

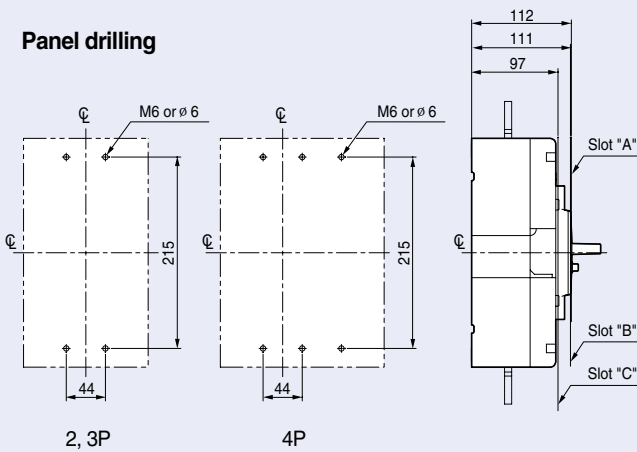

Front panel cutting

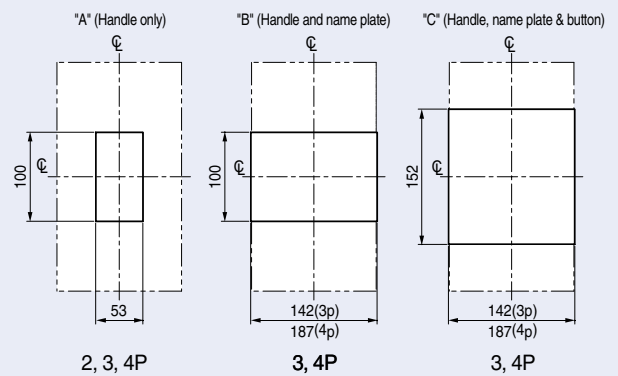

MCCB

ABN800c ABS800c ABL800c

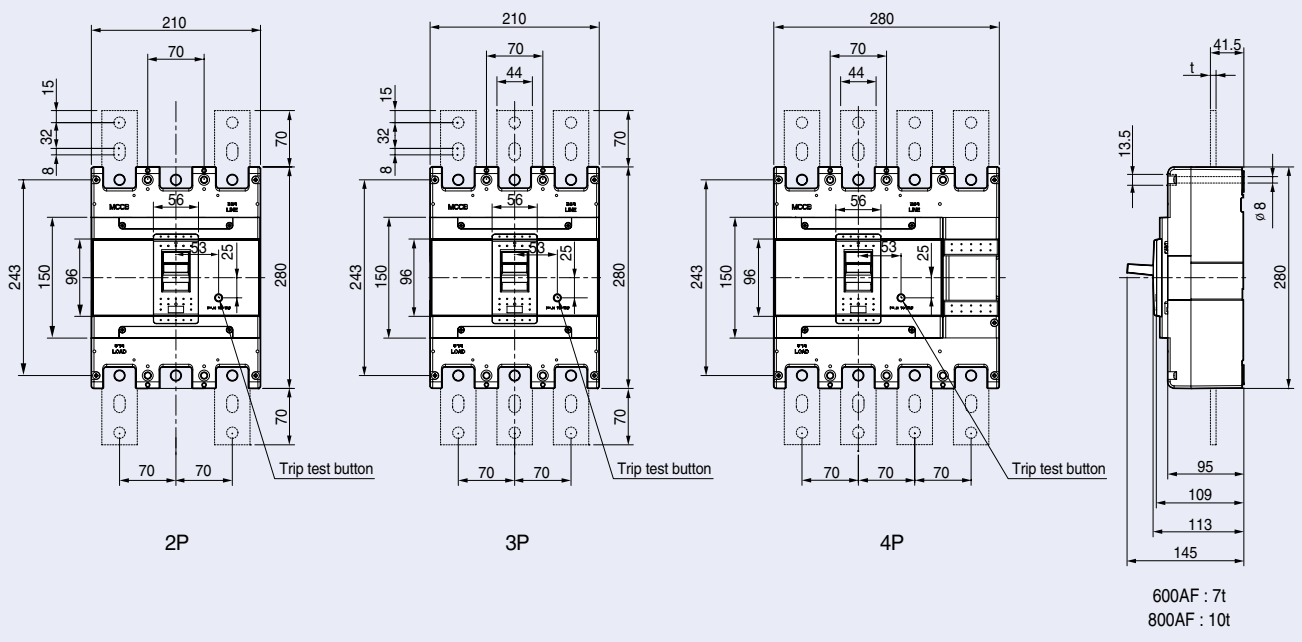

Terminal details

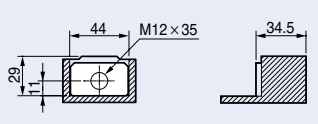

Connecting

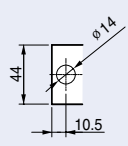

Panel drilling

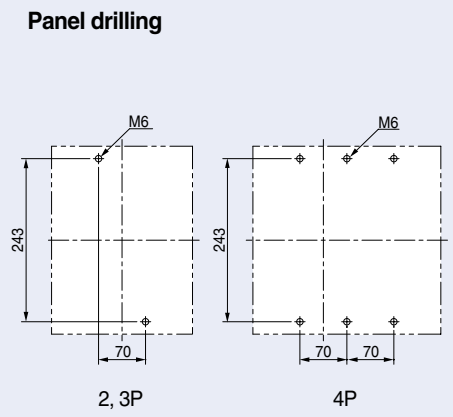

Front panel cutting

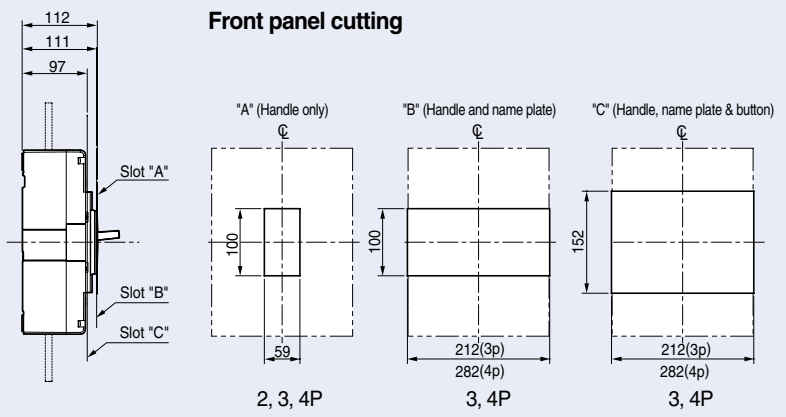

Dimensions

MCCB

ABS1000b	ABL1000b
ABS1200b	ABL1200b

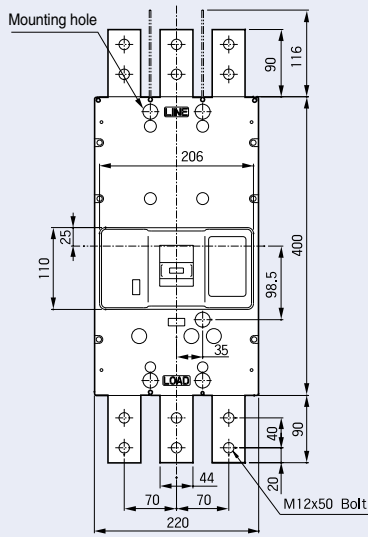

3P

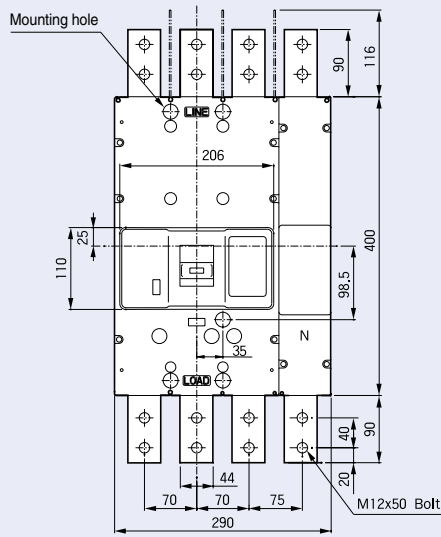

4P

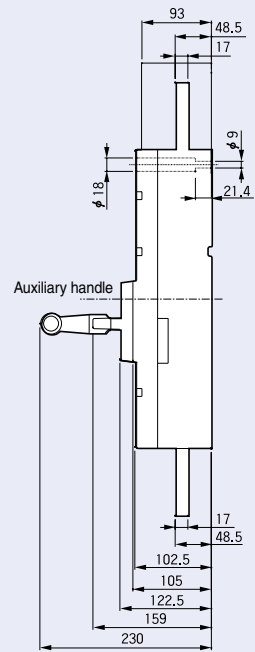

Panel drilling

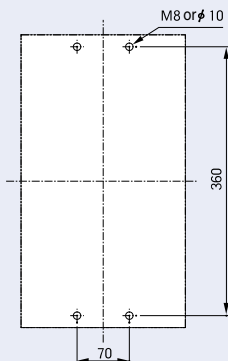

3P

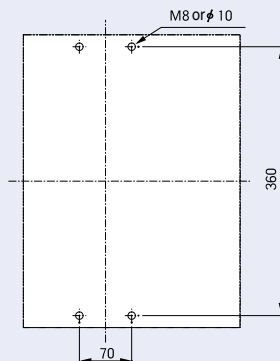

4P

Front panel cutting

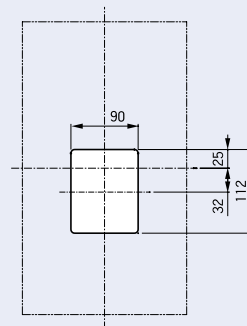

3P

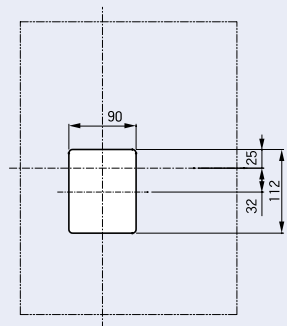

4P

ELCB

ABS1203bE

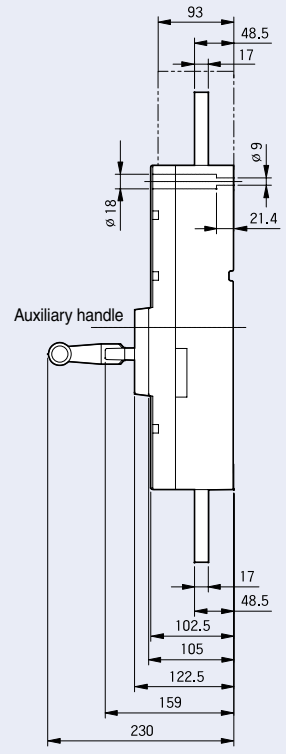
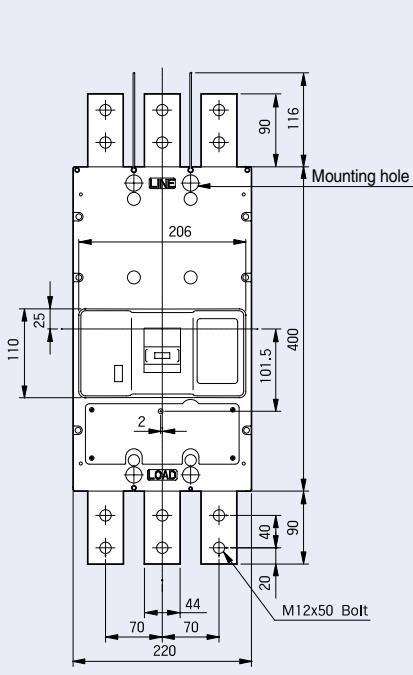

Panel drilling

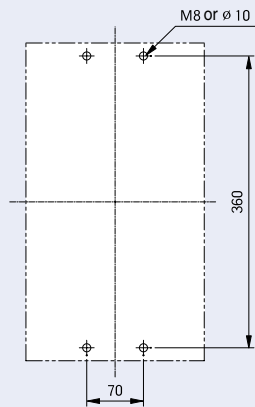

Front panel cutting

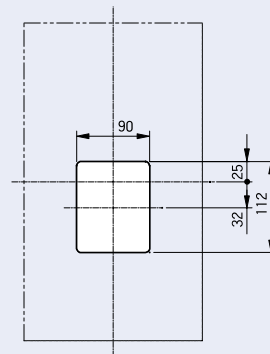

Dimensions

ELCB

EBN50c	EBS30c
EBN60c	EBS50c
EBN100c	EBS60c

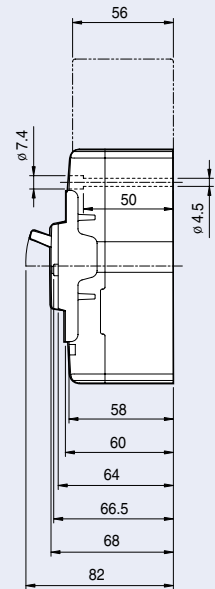
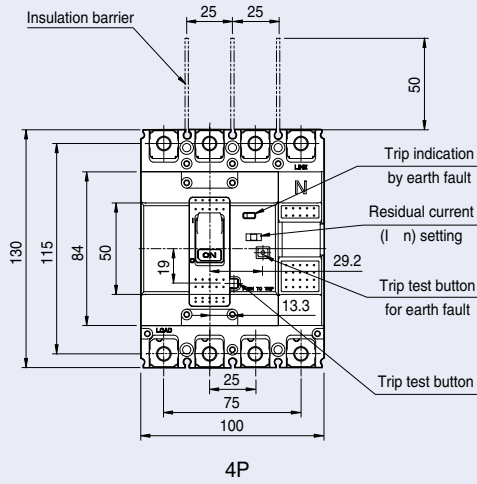
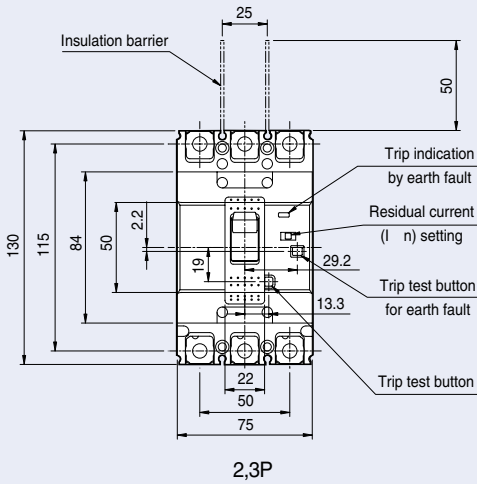

Terminal details

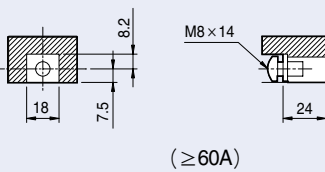
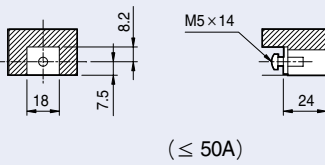

Connecting

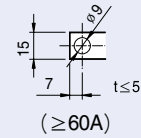
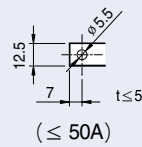

Panel drilling

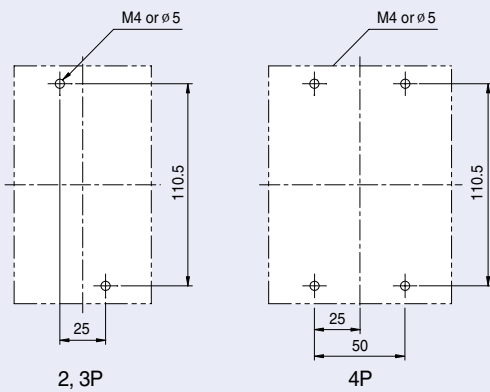

Front panel cutting

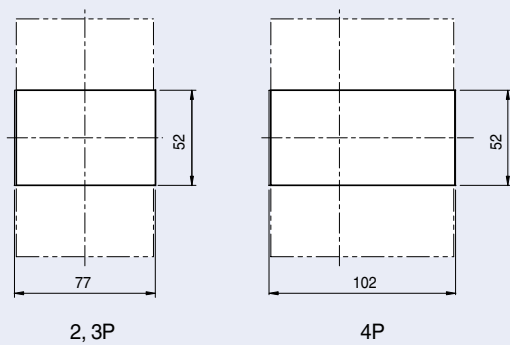

ELCB

EBS125c

EBH50c

EBH125c

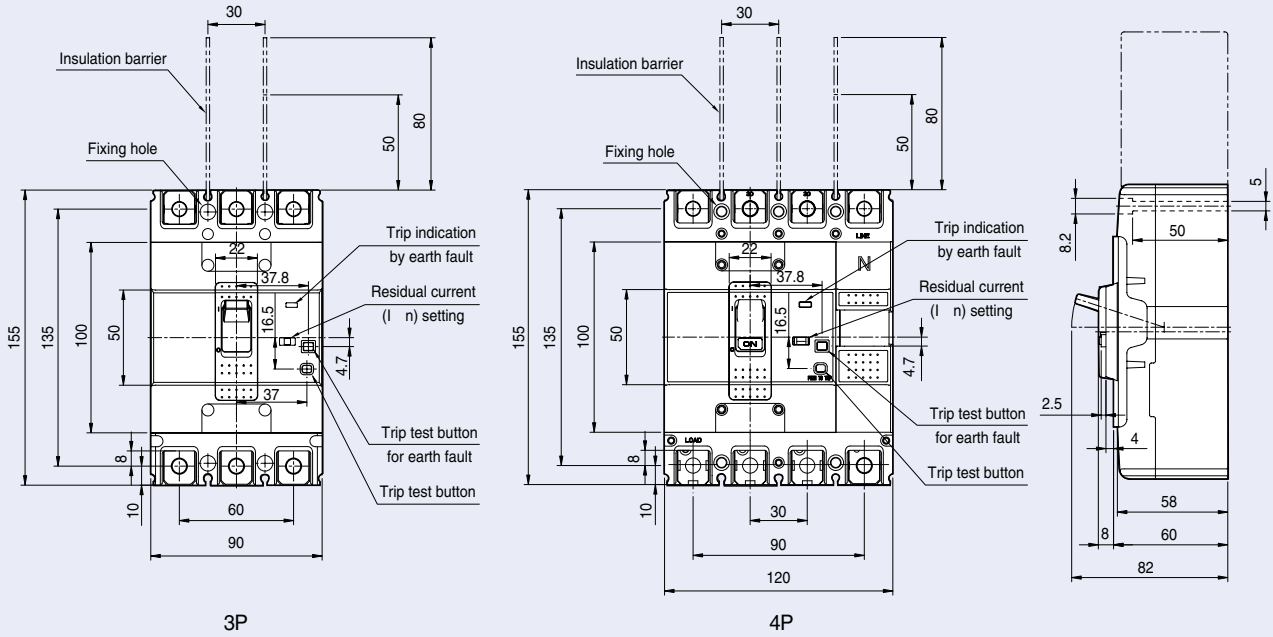

Terminal details

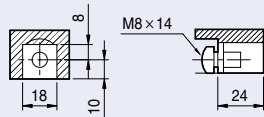

Connecting

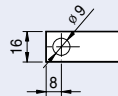

Panel drilling

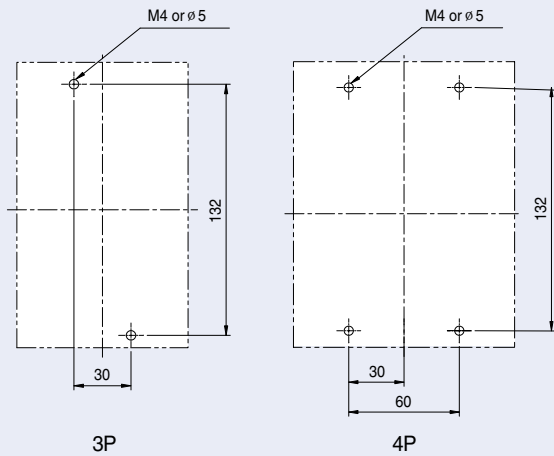

Front panel cutting

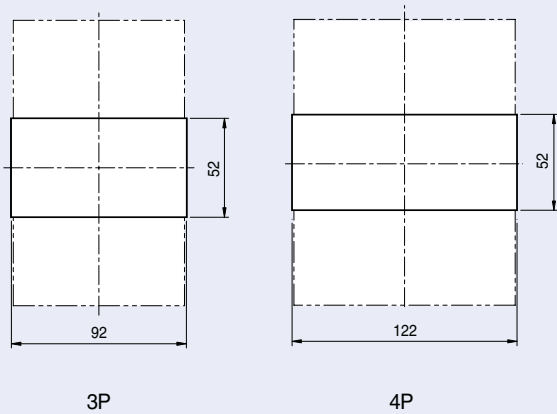

Dimensions

ELCB

EBN250c

EBS250c

EBH250c

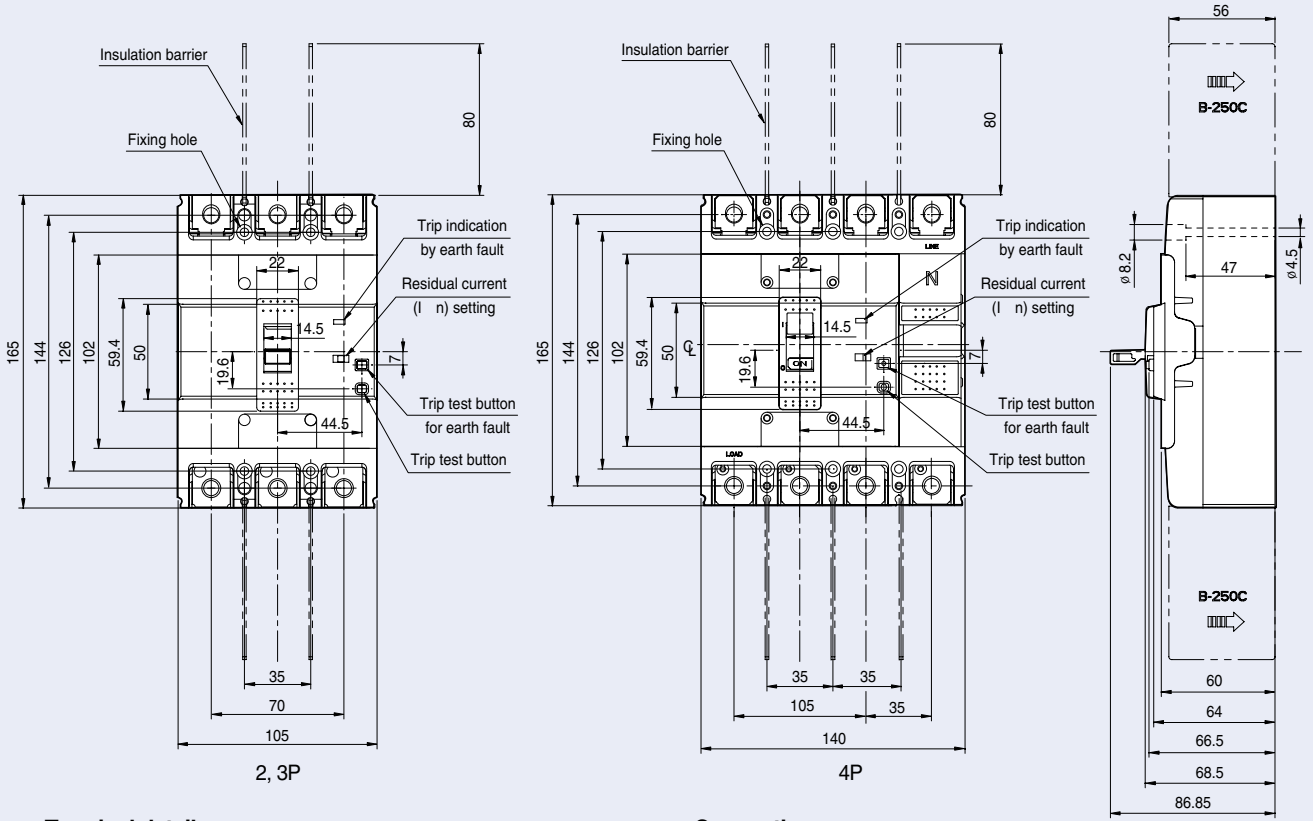

Terminal details

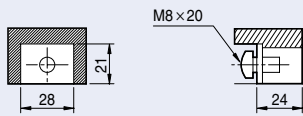

Connecting

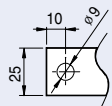

Panel drilling

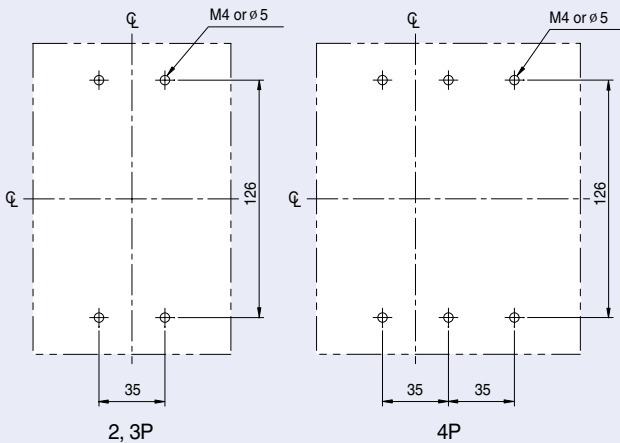

Front panel cutting

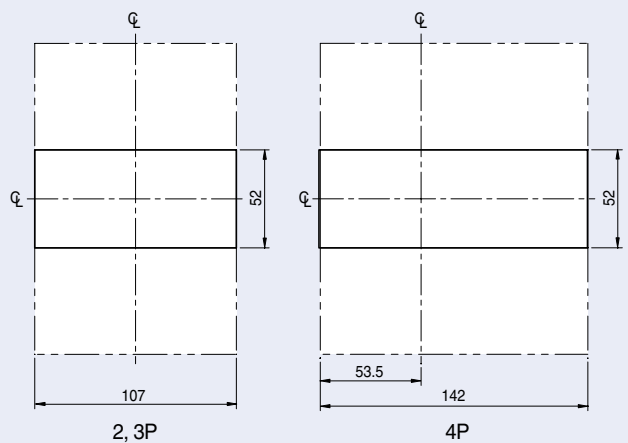

ELCB

- EBN400c
- EBS400c
- EBH400c
- EBL400c

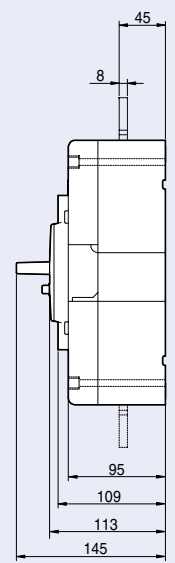
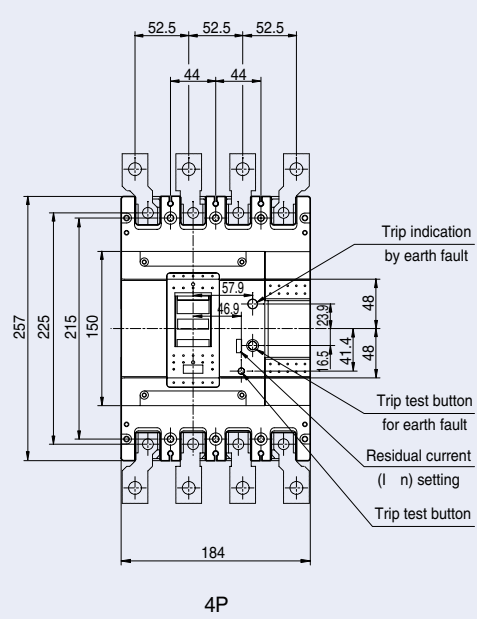
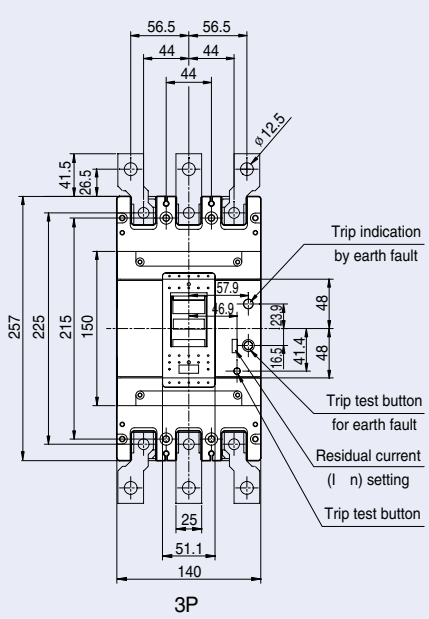

Terminal details

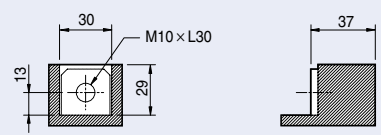

Connecting

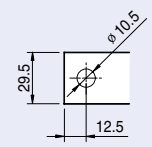

Panel drilling

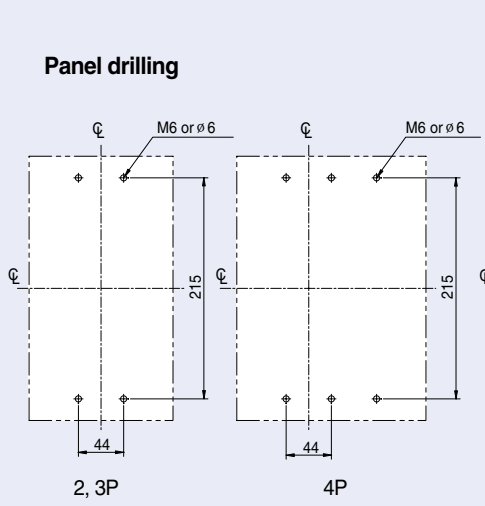

Front panel cutting

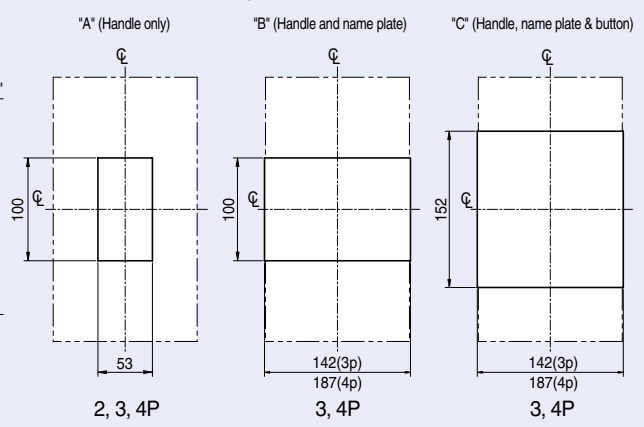

Dimensions

ELCB

EBN800c

EBS800c

EBL800c

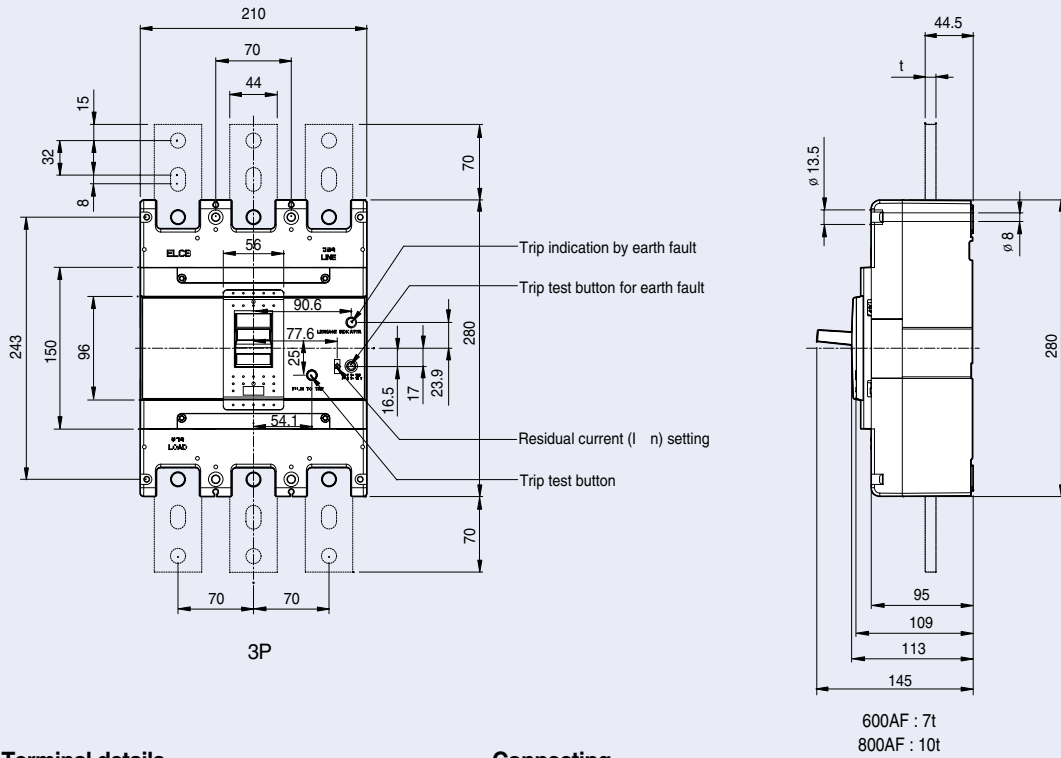

Terminal details

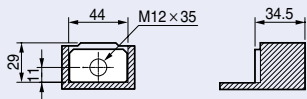

Connecting

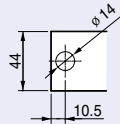

Panel drilling

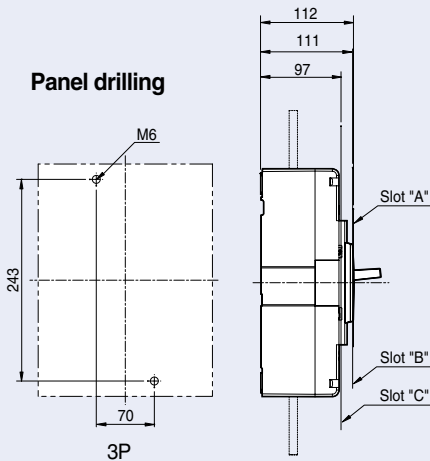

Front panel cutting

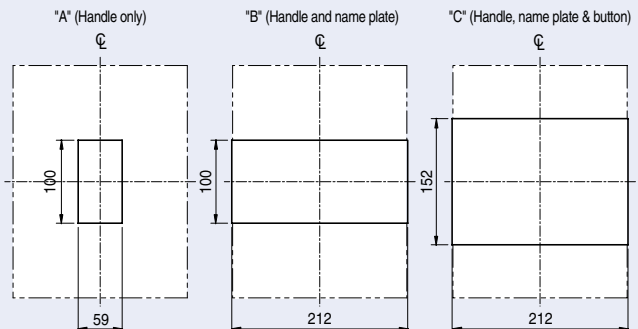

ELCB

EBS1000b

EBS1200b

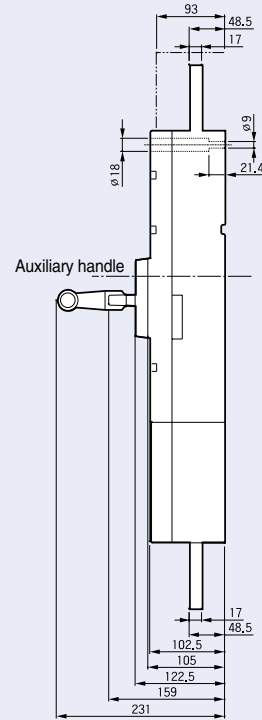
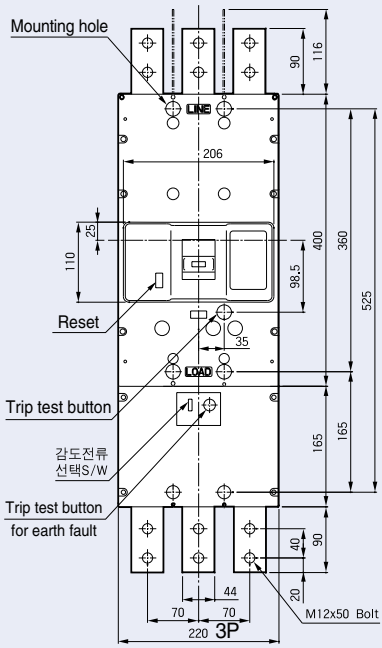

Panel drilling

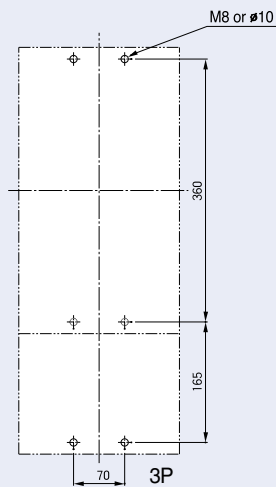

Front panel cutting

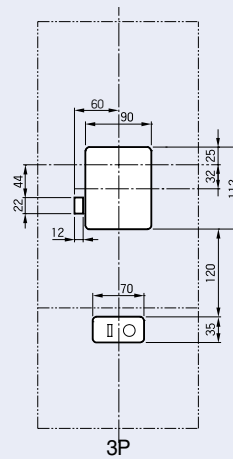

Rear connection terminals

Bar type

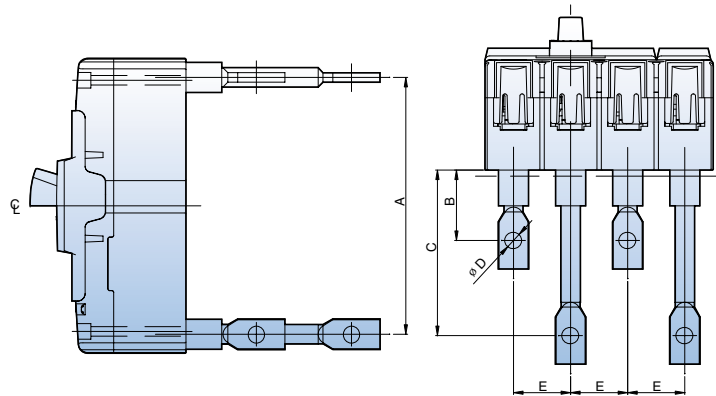

MCCB	A	B	C	D	E
ABN100c	115	37	87	ø 8.5	25
ABH125c	135	37	87	ø 8.5	30
ABH250c	144	57.5	93.5	ø 8.5	35
ABS400c	225	72	-	ø 14	44
ABS800c	243	108.7	-	ø 14	70

Round type

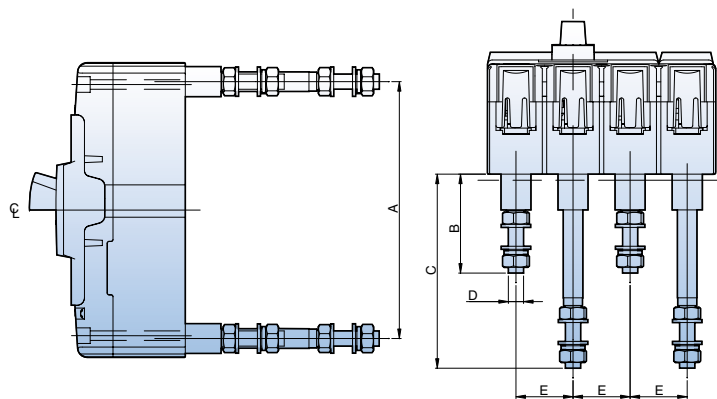

MCCB	A	B	C	D	E
ABN100c 50AF	115	42	92	M6	25
ABN100c 100AF	115	52	102	M8	25
ABH125c	135	52	102	M8	30
ABH250c	144	70	106	M8	35

Rotary handles

Direct mounting type (D-Handle, 30~250AF)

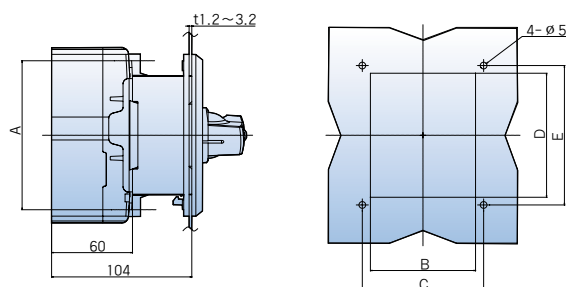

Type	A (mm)	B (mm)	C (mm)	D (mm)	E (mm)	Remarks
DH100	110.5	78	90	92	103.4	100AF
DH125	132	94	105	108	120	125AF
DH250	126	108	121	110	122	250AF

Direct mounting type (N-Handle, 400~800AF)

E-70, N-80

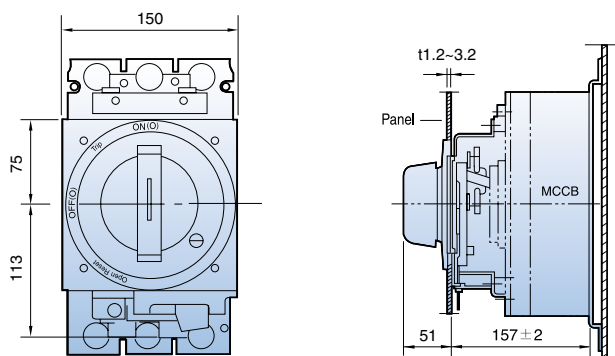

Rotary handles

Extended mounting type (E-Handle) (30~250AF)

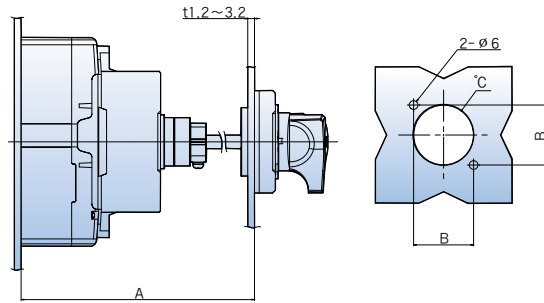

Type	A (mm)	B (mm)	C (mm)	Remarks
EH100	min 150, max 573.5 (SHAFT469mm)	47	ø 53	100AF
EH125	min 150, max 573.5 (SHAFT469mm)	47	ø 53	125AF
EH250	min 150, max 571.5 (SHAFT469mm)	47	ø 53	250AF

Extended mounting type (N-Handle, 400~800AF)

E-70U (400AF)

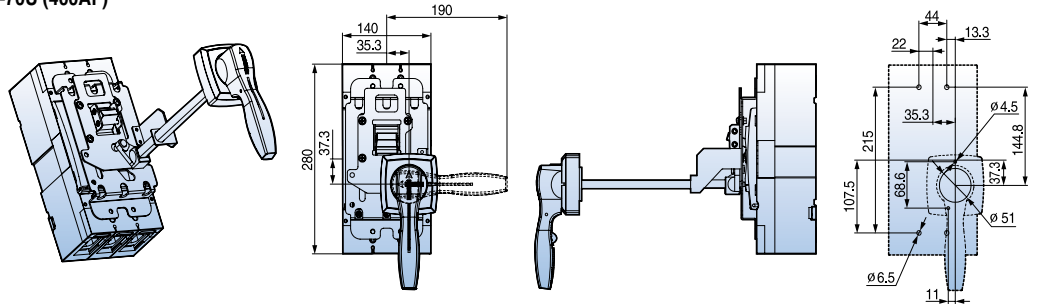



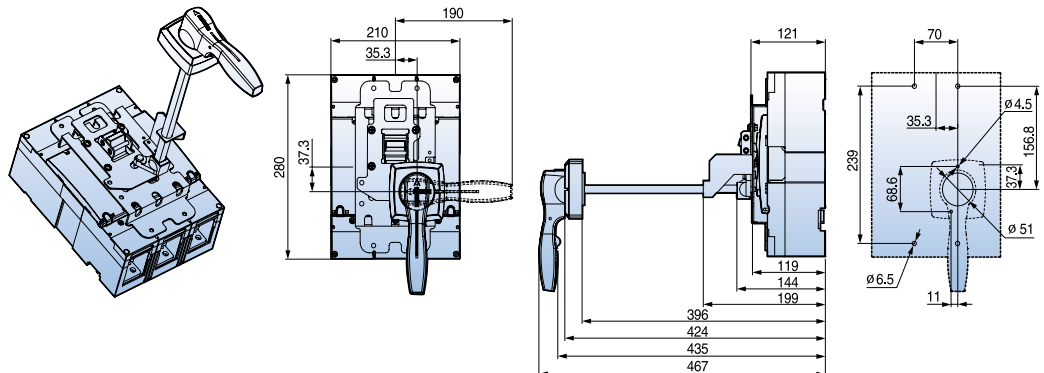









E-80U (800AF)

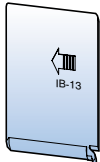
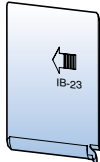

Standard accessories

The following accessories for mounting, connection and insulation are standard items and are packed with Metasol series circuit breakers.

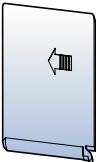
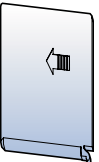
Item	ABN100c	ABH125c	ABH250c	400AF	800AF
Fixing screw					
	2P: 2EA (M4 × 60) 3P: 2EA (M4 × 60) 4P: 4EA (M4 × 60)	2P: 2EA (M4 × 60) 3P: 2EA (M4 × 60) 4P: 4EA (M4 × 60)	2P: 2EA (M4 × 55) 3P: 4EA (M4 × 55) 4P: 4EA (M4 × 55)	2P: 2EA (M6 × 100) 3P: 4EA (M6 × 100) 4P: 4EA (M6 × 100)	2P: 2EA (M6 × 100) 3P: 4EA (M6 × 100) 4P: 4EA (M6 × 100)
Terminal bolt					
	15~30A 2P: 4EA (M5 × 14) 3P: 6EA (M5 × 14) 4P: 8EA (M5 × 14) 40~100A 2P: 4EA (M8 × 14) 3P: 6EA (M8 × 14) 4P: 8EA (M8 × 14)	2P: 4EA (M8 × 14) 3P: 6EA (M8 × 14) 4P: 8EA (M8 × 14)	2P: 4EA (M8 × 20) 3P: 6EA (M8 × 20) 4P: 8EA (M8 × 20)	2P: 4EA (M10 × 30) 3P: 6EA (M10 × 30) 4P: 8EA (M10 × 30)	2P: 2EA (M12 × 35) 3P: 6EA (M12 × 35) 4P: 8EA (M12 × 35)
Insulation barrier					
	2P: 1EA 3P: 2EA 4P: 3EA	2P: 1EA 3P: 2EA 4P: 3EA	2P: 1EA 3P: 2EA 4P: 3EA	2P: 1EA 3P: 2EA 4P: 3EA	2P: 1EA 3P: 2EA 4P: 3EA

Connection

MCCB	Terminal (mm)	Tightening torque (kgf · cm)	Conductor (mm)
ABN100c	<p>[3~30A]</p>	<p>M5 : 23 ~ 28 M8 : 55 ~ 75</p>	<p>[15~30A]</p>
	<p>[40~100A]</p>		<p>[40~100A]</p>
ABH125c		<p>M8 : 55 ~ 75</p>	
ABH250c		<p>M8 : 80 ~ 130</p>	

Connection

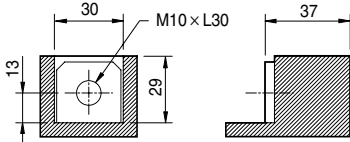
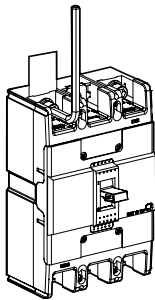
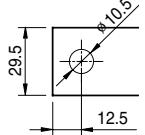
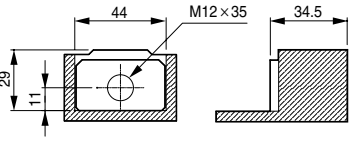
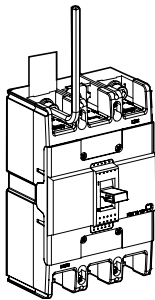
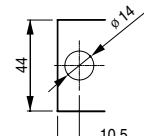
MCCB	Terminal (mm)	Tightening torque (kgf · cm)	Conductor (mm)
400AF		<p>M10 : 240~300 (Terminal) M10 : 240~300 (Busbar)</p> 	
800AF		<p>M12 : 400~500 (Terminal, Busbar)</p> 	

Safety clearance

When installing a circuit breaker, safety clearances must be kept between the breaker and panels, bars and other protection devices installed nearby. These safety clearances are depend on the ultimate breaking capacity and are defined by tests carried out in accordance with standard IEC 60947-2.

When a short circuit interruption occur, high temperatures pressures are present in and above the arc chambers of the circuit-breaker. In order to allow the pressure to be distributed and to prevent fire and arcing or short-circuit currents, safety clearances are required.

A: Minimum distance to metallic top panels

Frame size	Description	A(mm)	
		460V	250V
100AF	ABN50c	40	25
	ABN60c	40	25
	ABN100c	50	30
	ABS30c	30	25
	ABS50c	40	30
	ABS60c	40	30
125AF	ABS125c	50	40
	ABH50c	50	40
	ABH125c	100	80
250AF	ABN250c	100	80
	ABS250c	100	80
	ABH250c	100	80
400AF	ABN400c	100	80
	ABS400c	100	80
	ABH400c	100	80
	ABL400c	100	80
800AF	ABN800c	100	80
	ABS800c	100	80
	ABL800c	100	80

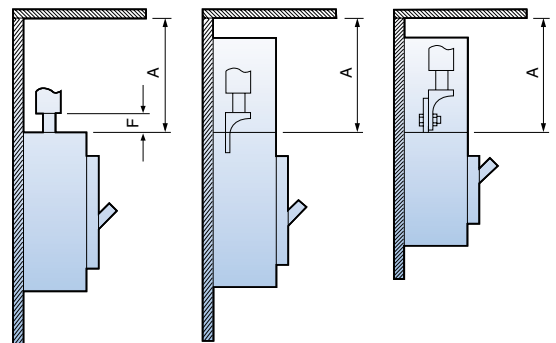

B: Minimum distance between the lower and the upper breakers

- C1: Minimum distance between the lower breaker and the bare terminal of the upper breaker
- C: C1+ the dimension of bare part of conductor

Frame size	Description	C1 (mm)		C (mm)
		460V	250V	
100AF	ABN50c	40	25	
	ABN60c	40	25	
	ABN100c	50	30	
	ABS30c	30	25	
	ABS50c	40	30	
	ABS60c	40	30	
125AF	ABS125c	50	40	
	ABH50c	50	40	
	ABH125c	100	80	
250AF	ABN250c	100	80	
	ABS250c	100	80	
	ABH250c	100	80	
400AF	ABN400c	100	80	
	ABS400c	100	80	
	ABH400c	100	80	
	ABL400c	100	80	
800AF	ABN800c	100	80	
	ABS800c	100	80	
	ABL800c	100	80	

The dimension of bare conduct + C1

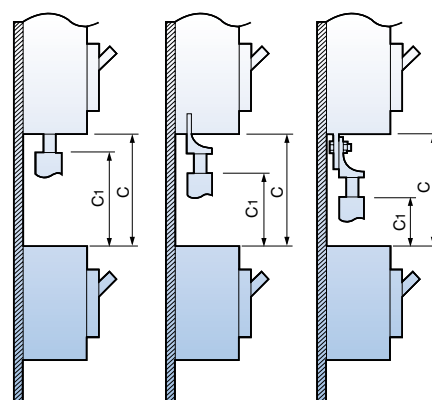

Direct connection of cable

Connection by using a crimp-type terminal lug

Connection by using a crimp-type terminal lug to the extended terminal

Safety clearance

Insulated length of main terminal of circuit breaker

- D1: Connection by solderless terminal with taping
- D2: Connection by busbar with taping
- D3: Connection by solderless terminal and using insulation barrier
- D4: Connection by busbar and using insulation barrier

Frame size	Description	D1 (mm)	D2 (mm)	D3 (mm)	D4 (mm)
100AF	ABN50c	The dimension of bare conduct + 20	40	The dimension of bare conduct + 20	40
	ABN60c		40		40
	ABN100c		50		50
	ABS30c		30		30
	ABS50c		40		40
	ABS60c		40		40
125AF	ABS125c		50		50
	ABH50c		50		50
	ABH125c		50		50
250AF	ABN250c		50		50
	ABS250c		50		50
	ABH250c		50		50
400AF	ABN400c	100	100		
	ABS400c	100	100		
	ABH400c	100	100		
	ABL400c	100	100		
800AF	ABN800c	150	150		
	ABS800c	150	150		
	ABL800c	150	150		

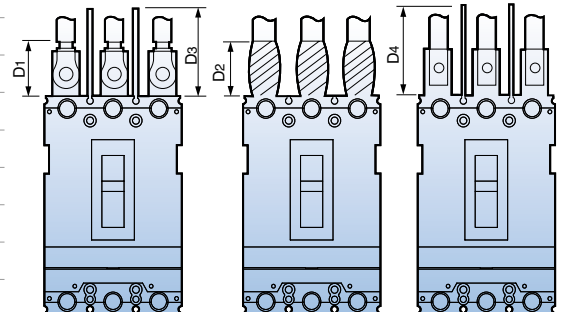

Minimum distance to metallic side panels

Frame size	Description	E(mm)	
		460V	250V
100AF	ABN50c	25	15
	ABN60c	25	15
	ABN100c	25	15
	ABS30c	20	15
	ABS50c	25	15
	ABS60c	25	15
125AF	ABS125c	25	15
	ABH50c	25	15
	ABH125c	50	20
250AF	ABN250c	50	15
	ABS250c	50	15
	ABH250c	50	15
400AF	ABN400c	80	40
	ABS400c	80	40
	ABH400c	80	40
	ABL400c	80	40
800AF	ABN800c	80	40
	ABS800c	80	40
	ABL800c	80	40

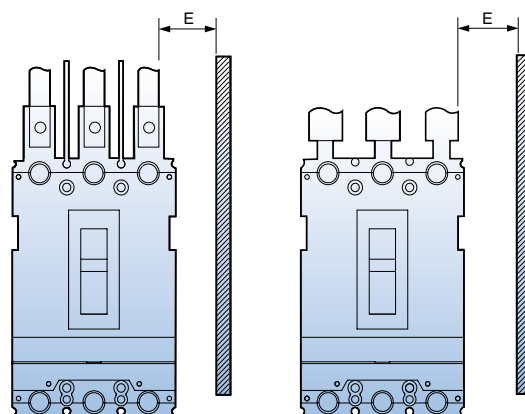

Safety clearance

Distance of bare cables or busbars

Frame size	Description	F(mm)
100AF	ABN50c	10
	ABN60c	10
	ABN100c	-
	ABS30c	5
	ABS50c	10
	ABS60c	10
125AF	ABS125c	-
	ABH50c	10
	ABH125c	20
250AF	ABN250c	-
	ABS250c	-
	ABH250c	-
400AF	ABN400c	10
	ABS400c	10
	ABH400c	10
	ABL400c	10
800AF	ABN800c	10
	ABS800c	10
	ABL800c	10

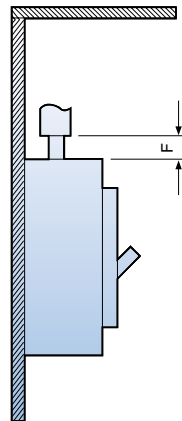

Minimal distance between two adjacent breakers (With terminal covers)

Frame size	Description	G(mm)
100AF	ABN50c	0
	ABN60c	0
	ABN100c	0
	ABS30c	0
	ABS50c	0
	ABS60c	0
125AF	ABS125c	0
	ABH50c	0
	ABH125c	0
250AF	ABN250c	0
	ABS250c	0
	ABH250c	0
400AF	ABN400c	0
	ABS400c	0
	ABH400c	0
	ABL400c	0
800AF	ABN800c	0
	ABS800c	0
	ABL800c	0

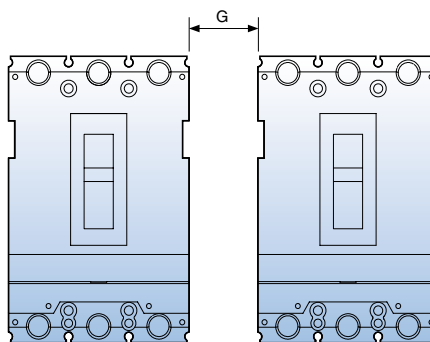

Standards & Approval

Metasol series circuit breakers and auxiliaries comply with the following international standard:

- IEC 60947-1
Low-voltage switchgear and controlgear - Part 1: General rules
- IEC 60947-2
Low-voltage switchgear and controlgear - Part 2: Circuit-breakers

The following certificates are available on a request.

- CE Declaration of conformity
- Certificate of conformance test (CB) - IEC 60947
- Full type test report issued by KEMA

CE conformity marking

The CE conformity marking shall indicate conformity to all the obligations imposed on the manufacturer, as regards his products, by virtue of the European Community directives providing for the affixing of the CE marking.

When the CE marking is affixed on a product, it represents a declaration of the manufacturer or of his authorized representative that the product in question conforms to all the applicable provisions including the conformity assessment procedures.

IEC CB TEST CERTIFICATE		Ref. Certificate No.
		NL-14196/A1
IEC SYSTEM FOR MUTUAL RECOGNITION OF TEST CERTIFICATES FOR ELECTRICAL EQUIPMENT (IECEE) CB SCHEME		
Issued by:	KEMA Quality B.V.	
Product:	Moulded case circuit-breaker	
Applicant:	LS Industrial Systems Co., Ltd.	1026-6, Hagye-dong, Dong-an-gu Anyang-si, Gyeonggi-do, Korea, Republic of
Manufacturer:	LS Industrial Systems Co., Ltd.	1026-6, Hagye-dong, Dong-an-gu Anyang-si, Gyeonggi-do, Korea, Republic of
Factory:	LS Industrial Systems Co., Ltd. Cheongju Plant	1, Songjeong-dong, Heungdeok-gu Cheongju-si, Chungcheongbuk-do, Korea, Republic of
Rating and principal characteristics:	3 poles MCCB (thermal/magnetic) In = 15, 20, 30, 40, 50, 60, 75, 100, 125 A Ue = 220, 240, 250, 415, 440, 460 Vac Ui = 750 Vac Uimp = 6 kV Ics = 100 kA at 220, 240, 250 V and 50 kA at 415, 440, 460 V, Ics = 100%Icu Rated frequency = 50/60 Hz Cat A.	
Trade mark (if any):	LS	
Model/Type reference:	ABH53c, ABS103c, ABH103c	
Additional information:	WMT procedure	
Sample of product tested to be in conformity with IEC:	60947-2(ed.4)	
Test Report Ref. No.:	2109959.51 (156 pages)	
This CB Test Certificate is issued by the National Certification Body:		
KEMA Quality B.V. Utrechtseweg 310 P.O. Box 5185 6802 ED Arnhem The Netherlands		
Signed by: H.L. Schendstok		
Date of issue: 2008-05-21		

IEC CB TEST CERTIFICATE		Ref. Certificate No.
		NL-14216/A2
IEC SYSTEM FOR MUTUAL RECOGNITION OF TEST CERTIFICATES FOR ELECTRICAL EQUIPMENT (IECEE) CB SCHEME		
Issued by:	KEMA Quality B.V.	
Product:	Moulded case circuit-breaker (earth leakage circuit-breaker)	
Applicant:	LS Industrial Systems Co., Ltd.	1026-6, Hagye-dong, Dong-an-gu Anyang-si, Gyeonggi-do, Korea, Republic of
Manufacturer:	LS Industrial Systems Co., Ltd.	1026-6, Hagye-dong, Dong-an-gu Anyang-si, Gyeonggi-do, Korea, Republic of
Factory:	LS Industrial Systems Co., Ltd. Cheongju Plant	1, Songjeong-dong, Heungdeok-gu Cheongju-si, Chungcheongbuk-do, Korea, Republic of
Rating and principal characteristics:	3 pole Earth leakage circuit-breaker (thermal/magnetic with electronic ground fault detection: 30 mA, 100/200/500 mA) In = 15, 20, 30, 40, 50, 60, 75, 100 and 125A Ue = 220, 240, 250 and 415, 440, 460 Vac Ui = 460 Vac Uimp = 6 kV Icu = 100 kA at 220, 240, 250 V and Ics = 50 kA at 415, 440, 460 V Ics = 100%Icu Rated frequency = 50/60 Hz Cat A.	
Trade mark (if any):	LS	
Model/Type reference:	EBS 103c, EBH 53c, EBH103c	
Additional information:	WMT procedure	
Sample of product tested to be in conformity with IEC:	60947-2(ed.4)	
Test Report Ref. No.:	2109959.54	
This CB Test Certificate is issued by the National Certification Body:		
KEMA Quality B.V. Utrechtseweg 310 P.O. Box 5185 6802 ED Arnhem The Netherlands		
Signed by: H.L. Schendstok		
Date of issue: 2008-06-05		

Standard Use Environment

Standard Use Environment for Molded Case Circuit Breaker

The operation characteristic of Molded Case Circuit Breaker including short-circuit, overload, endurance and insulation is often influenced largely by external environment and thus should be applied appropriately with conditions of the place where it is used taken into consideration. In particular, the operation characteristic of the circuit breaker with a thermal magnetic trip element (FTU, FMU, ATU) applied changes a bit with the ambient temperature so you have to adjust the value of power rating accordingly when it is actually in use.

- 1) Ambient Temperature: Within the range of -5°C ~ $+40^{\circ}\text{C}$ (However, the average for the duration of 24 hours must not exceed 35°C .)
- 2) Relative Humidity: Within the range of 45~85%
- 3) Altitude: 2,000m or less (However, if it exceeds 1,000m, atmosphere correction through humidity test and withstand voltage test can be considered.)
- 4) Atmosphere where excessive steam, oil steam, smoke, dust, salt and other corrosive materials do not exist



- If a standard circuit breaker is used in high temperature exceeding 40°C , you are advised to use it according to the current corrected for each level of ambient temperature in catalog.
- If used in conditions of highly humidity, the dielectric strength or electric performance may be degraded.



- There is no problem in conduction switch, trip or short circuit isolation in the temperature of -20°C .
- Passing or storage in stone-cold area is allowed in the temperature of 40°C .
- The operating characteristic of the breaker with a thermal magnetic trip element changes as the base ambient temperature is adjusted to 40°C .



- It is highly recommended to use a dust cover or anti-humid agent if it is used in dusty and humid conditions.
- Excessive vibration may cause a trip break such as connection fault or flaw on mechanical parts.



- If it is left ON or OFF for a long time, it is recommended to switch load current on a regular basis.
- It is recommend to put it in the sealed protection if corrosive gas is prevalent.

Special Use Environment

Environment where Ambient Temperature Exceeds 40°C

The temperature of each module of a Molded Case Circuit Breaker is the sum of temperature increase by conduction and ambient temperature and if the ambient temperature exceeds 40°C the passing current needs to be reduced so that the temperature of such element as internal insulator of MCCB exceed the maximum allowable temperature.

The base ambient temperature of Metasol breaker is set as 40°C so if it has to be used in conditions with higher temperature than this, the rated current is required to be reduced a little as described in the table below.

Table of Rated Current for Metasol MCCB Corrected according to Ambient Temperature

Ampere Frame	Rated current	Model Name of Breaker	Rated current	Table of Rated Current Corrected according to Ambient Temperature (A)							
				10°C	20°C	30°C	40°C	45°C	50°C	55°C	
30	3	ABS30c	3	3	3	3	3	3	3	3	
	5		5	5	5	5	5	5	4		
	10		10	10	10	10	10	10	9	9	
	15		15	15	15	15	15	15	14	13	
	20		20	20	20	20	20	19	19	18	
	30	30	30	30	30	30	29	28	27		
	50	40	ABN50c, ABS50c	40	40	40	40	40	39	38	36
		50		50	50	50	50	49	47	45	
	60	60	ABN60c, ABS60c	60	60	60	60	60	58	56	55
	100	75	ABN100c	75	75	75	75	75	73	71	68
100		100		100	100	100	97	94	91		
125	125	ABH50c, ABS125c, ABH125c	125	125	125	125	125	121	116	107	
250	150	ABN200c, ABS200c, ABH250c	150	150	150	150	150	145	140	128	
	175		175	175	175	175	169	163	150		
	200		200	200	200	200	193	186	171		
	225		225	225	225	225	217	209	193		
400	250	ABN400c, ABS400c ABH400c, ABL400c	250	250	250	250	250	246	242	238	
	300		300	300	300	300	295	291	287		
	350		350	350	350	350	345	339	332		
	400		400	400	400	400	394	388	381		
800	500	ABN800c, ABS800c ABL800c	500	500	500	500	500	492	485	477	
	630		630	630	630	630	621	611	602		
	700		700	700	700	700	689	679	668		
	800		800	800	800	800	788	776	764		

Table of Rated Current for Metasol ELCB Corrected according to Ambient Temperature

Ampere Frame	Rated current	Model Name of Breaker	Rated current	Table of Rated Current Corrected according to Ambient Temperature (A)							
				10°C	20°C	30°C	40°C	45°C	50°C	55°C	
30	15	EBS30c	15	15	15	15	15	15	15	15	
	20		20	20	20	20	19	19	18		
	30		30	30	30	30	29	28	27		
	50	40	EBN50c, EBS50c	40	40	40	40	40	39	38	36
		50		50	50	50	50	49	47	45	
	60	60	EBN60c, EBS60c	60	60	60	60	60	58	56	55
	100	75	EBN100c	75	75	75	75	75	73	71	68
		100		100	100	100	100	97	94	91	
125	125	EBH50c, EBS125c, EBH125c	125	125	125	125	125	121	116	107	
250	150	EBN200c, EBS200c, EBH250c	150	150	150	150	150	145	140	128	
	175		175	175	175	175	169	163	150		
	200		200	200	200	200	193	186	171		
	225		225	225	225	225	217	209	193		
	250		250	250	250	250	241	233	214		
400	250	EBN400c, EBS400c EBH400c, EBL400c	250	250	250	250	250	246	242	238	
	300		300	300	300	300	295	291	287		
	350		350	350	350	350	345	339	332		
	400		400	400	400	400	394	388	381		
800	500	EBN800c, EBS800c EBL800c	500	500	500	500	500	492	485	477	
	630		630	630	630	630	621	611	602		
	700		700	700	700	700	689	679	668		
	800		800	800	800	800	788	776	764		

Special Use Environment

Environment where Ambient Temperature is -5°C or less

Molded Case Circuit Breaker is subject to the effect of low temperature brittle of metal part inside and insulator, or changes in viscosity of lubricating oil in device, extra care should be taken not to have the temperature drop extremely with the use of such device as space heater. In addition, in case of using a thermal magnetic trip element (FTU, FMU, ATU), the operating characteristic changes toward the difficult direction, so you should identify the relationship of protection and correct accordingly.

Although MCCB is not affected by conduction switch, trip, or short circuit isolation in the temperature of -20°C, it is highly recommended to use a temperature maintaining device such as space heater. In addition, transportation and passing in stone-cold area in the temperature as low as -40°C is allowed but it is recommend to leave the status of MCCB off or tripped in order to minimize the effect of brittle due to a low temperature.

High Humidity Condition (Relative Humidity 85% or more)

Using Molded Case Circuit Breaker in a place of high humidity requires a rigorous maintenance including installation of anti-humidity agent within the structure in order to prevent the insulation sag of insulator or corrosion of mechanical parts as a result of high humidity. Also, in case of installing MCCB within the enclosed equipment, a space heater needs to be installed as well to prevent dew condensation that might occur due to a drastic temperature change.

Environment where Petrochemical Gas Exists

The contact material of Molded Case Circuit Breaker is silver or silver alloy which develops creation of petrochemical coat that might cause a poor connection if it gets in contact with petrochemical gas.

However, it is easy for petrochemical coat to be mechanically taken off so it is no problem if make-and break operation occurs frequently but it needs to be switched back and forth between make and break if the operation rarely occurs.

The lead wire of moving contact of Molded Case Circuit Breaker can be disconnected as it is corroded or hardened by petrochemical gas. The silver coating is effective to prevent this from occurring and there is a need to increase durability of MCCB with the use of silver coated lead wire if it is used in environment with thick petrochemical gas.

Environment where Potentially Explosive Gas Exists

It is advised, in principle, not to install a Molded Case Circuit Breaker that switches and inhibits current in a dangerous place such as this one.

Impact of Altitude

If an MCCB is used in an elevated area higher than 2000m sea level, its operating performance is subject to dramatic drop in atmospheric pressure and temperature. For example, the air pressure is reduced to 80% of ordinary pressure at 2,200m and further 50% at 5,500m although the short-circuit performance is not affected. If it is used in areas of high sea level, you can do correction based on the correction parameter table in high altitude environment, as described below.

* Refer to the correction parameter table in high altitude environment (ANSI C37. 29-1970)

1) How to Correct Voltage:

- If the rated voltage is AC 600V at 4,000m above sea level,
 $600V \text{ (rated voltage)} \times 0.82 \text{ (correction parameter)} = 492V.$

2) How to Correct Current:

- If the rated current is AC 800A at above 4,000m sea level,
 $800A \text{ (rated current)} \times 0.96 \text{ (correction parameter)} = 768A.$

[Correction Parameter Table for Altitude]

Altitude	Voltage Correction Parameter	Current Correction Parameter
2,000m	1.00	1.00
3,000m	0.91	0.98
4,000m	0.82	0.96
5,000m	0.73	0.94
6,000m	0.65	0.92

Environment with Vibration and Impulse Exercised

Impact of Vibration and Impulse

An excessive vibration and impulse may cause damage on breaker or other security problems including dynamic strength. An appropriate consideration is required to select a right MCCB for an adverse environmental stress such as this one. Moreover, this stress may incur from vibration during transportation, magnetic impulse while manipulating a switch or may be affected by equipment in surrounding area.

There is a standard call [Vibration Testing Method for Small Electric Appliances] for vibration and impulse test for electric equipment and the seismic and endurance tests of Molded Case Circuit Breaker are conducted in accordance with this standard, considering the circumstance mentioned above.

Vibration

The magnitude of vibration is measured by double amplitude and frequency with the following equation with accelerator.

$$\alpha g = 0.002 \times \text{frequency (Hz)} \times \text{double amplitude (mm)}$$

* αg : multiple of gravitational acceleration ($g=9.8\text{m/sec}^2$)

There are three types of vibration tests including resonance test, vibration endurance test, and malfunction test as described below.

1) Resonant Test

Alter the frequency of sinusoidal wave within the range of 0~55Hz gradually with 0.5~1mm of double amplitude applied to see if there is any occurrence of vibration on a specific part of MCCB.

2) Vibration Endurance Test

A sinusoidal wave with double amplitude of 0.5~1mm and frequency of 55Hz(resonant frequency obtained in previous clause if there is a resonant point) is manually created to check the operational status.

3) Malfunction Test

Apply vibration for 10 minutes for each condition of altering double amplitude and frequency to check if there is any malfunction in MCCB.

Impulse

The magnitude of impulse is denoted by the multiple of gravitational acceleration imposed on the equipment and part. The test is conducted through a drop impulse test.

Impact of High Frequency

In case of high frequency current, you are required to reduce the rated current of the breaker with a thermal magnetic trip element embedded due to heat incurred by the skin effect of conductor and/or core loss of structure. The reduction rate varies according to the Frame Size and rated current and decreases down to 70~80% at 400Hz. In addition, the core loss decreases attractive force, which leads to increase of instantaneous trip current.

* Core loss: It refers to the electrical loss in a transformer caused by magnetization of the core that changes over time and is categorized into hysteresis loss and eddy current loss.

* Hysteresis loss: It takes up the majority portion of no-load loss of electric equipment and is calculated like this.

$$P_h = \sigma f B_m n$$

B_m : maximum value of magnetic flux density, n : constant(1.6~2.0), f : frequency, σ : hysteresis constant

* Eddy current: It refers to an induced electric current formed within the body of a conductor when it moves through a non-uniform or changing magnetic field. The eddy current that incurs at winding of transformer or core is considered as one of the transformer losses as a part of exciting current. It is also called 'eddy current loss'.

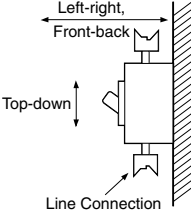
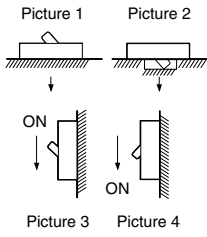

Use Environment with Vibration and Impulse Applied

[Table of Seismic Performance and Internal Impulse Performance]



		Test	Internal Impulse
Test Condition	Mounting	<ul style="list-style-type: none"> Vertical mounting Top-down, Left-right, Front-back 	<ul style="list-style-type: none"> Picture 1, 2, 3, 4 (→ represents the direction of drop) 
	Status of MCCB	(1) Non-conduction (ON or OFF status) (2) Status where rated current is conducted until the temperature of MCCB becomes constant and keeps being conducted	Non-conduction (ON or OFF status)
Test Result	Judgment Condition	<ul style="list-style-type: none"> If it is ON, it should not be OFF If it is OFF, it should not be ON No abnormal status such as damage, transformation, or annealing of nut part Characteristics of switch and trip after the test must be normal 	



Certifications

MCCB

Type	Approvals		Certificates
	Safet certi	IEC	KEMA
Mark and name			
Type	Korea	Europe	Netherlands
ABS32c	●	●	●
ABS33c	●	●	●
ABS34c	●	●	●
ABN52c	●	●	●
ABN53c	●	●	●
ABN54c	●	●	●
ABS52c	●	●	●
ABS53c	●	●	●
ABS54c	●	●	●
ABN62c	●	●	●
ABN63c	●	●	●
ABN64c	●	●	●
ABS62c	●	●	●
ABS63c	●	●	●
ABS64c	●	●	●
ABN102c	●	●	●
ABN103c	●	●	●
ABN104c	●	●	●
ABS32d	●	●	●
ABS33d	●	●	●
ABS34d	●	●	●
ABN52d	●	●	●
ABN53d	●	●	●
ABN54d	●	●	●
ABS52d	●	●	●
ABS53d	●	●	●
ABS54d	●	●	●
ABN62d	●	●	●
ABN63d	●	●	●
ABN64d	●	●	●
ABS62d	●	●	●
ABS63d	●	●	●
ABS64d	●	●	●
ABN102d	●	●	●
ABN103d	●	●	●
ABN104d	●	●	●
ABP52c	●	●	●
ABP53c	●	●	●
ABP54c	●	●	●
ABH52c	●	●	●
ABH53c	●	●	●
ABH54c	●	●	●
ABS102c	●	●	●
ABS103c	●	●	●
ABS104c	●	●	●
ABP102c	●	●	●
ABP103c	●	●	●

ELCB

Type	Approvals		Certificates
	Safet certi	IEC	KEMA
Mark and name			
Type	Korea	Europe	Netherlands
ABP104c	●	●	●
ABH102c	●	●	●
ABH103c	●	●	●
ABH104c	●	●	●
ABN202c	●	●	●
ABN203c	●	●	●
ABN204c	●	●	●
ABS202c	●	●	●
ABS203c	●	●	●
ABS204c	●	●	●
ABP202c	●	●	●
ABP203c	●	●	●
ABP204c	●	●	●
ABH202c	●	●	●
ABH203c	●	●	●
ABH204c	●	●	●
ABN402c	●	●	●
ABN403c	●	●	●
ABN404c	●	●	●
ABS402c	●	●	●
ABS403c	●	●	●
ABS404c	●	●	●
ABH402c	●	●	●
ABH403c	●	●	●
ABH404c	●	●	●
ABL402c	●	●	●
ABL403c	●	●	●
ABL404c	●	●	●
ABN602c	●	●	●
ABN603c	●	●	●
ABN604c	●	●	●
ABS602c	●	●	●
ABS603c	●	●	●
ABS604c	●	●	●
ABL602c	●	●	●
ABL603c	●	●	●
ABL604c	●	●	●
ABN802c	●	●	●
ABN803c	●	●	●
ABN804c	●	●	●
ABS802c	●	●	●
ABS803c	●	●	●
ABS804c	●	●	●
ABL802c	●	●	●
ABL803c	●	●	●
ABL804c	●	●	●

Type	Approvals		Certificates
	Safet certi	IEC	KEMA
Mark and name			
Type	Korea	Europe	Netherlands
EBS33c	●	●	●
EBS34c	●	●	●
EBN52c	●	●	●
EBN53c	●	●	●
EBS53c	●	●	●
EBS54c	●	●	●
EBN63c	●	●	●
EBS63c	●	●	●
EBS64c	●	●	●
EBN102c	●	●	●
EBN103c	●	●	●
EBN104c	●	●	●
EBS33d	●	●	●
EBS34d	●	●	●
EBN52d	●	●	●
EBN53d	●	●	●
EBS53d	●	●	●
EBS54d	●	●	●
EBN63d	●	●	●
EBS63d	●	●	●
EBS64d	●	●	●
EBN102d	●	●	●
EBN103d	●	●	●
EBN104d	●	●	●
EBP53c	●	●	●
EBP54c	●	●	●
EBH53c	●	●	●
EBH54c	●	●	●
EBS103c	●	●	●
EBS104c	●	●	●
EBP103c	●	●	●
EBP104c	●	●	●
EBH103c	●	●	●
EBH104c	●	●	●
EBN202c	●	●	●
EBN203c	●	●	●
EBS203c	●	●	●
EBS204c	●	●	●
EBP203c	●	●	●
EBP204c	●	●	●
EBH203c	●	●	●
EBH204c	●	●	●

Note: ● (Completion)

Memo

Metasol

Green Innovators of Innovation



Safety Instructions

- For your safety, please read user's manual thoroughly before operating.
- Contact the nearest authorized service facility for examination, repair, or adjustment.
- Please contact a qualified service technician when you need maintenance. Do not disassemble or repair by yourself!
- Any maintenance and inspection shall be performed by the personnel having expertise concerned.

LS Industrial Systems Co., Ltd.

© 2009.10 LS Industrial Systems Co.,Ltd. All rights reserved.

eng.lsis.biz

■ HEAD OFFICE

LS Tower 1026-6, Hogue-dong, Dongan-gu,
Anyang-si, Gyeonggi-do 431-848, Korea

Tel. (82-2)2034-4887, 4873, 4148

Fax. (82-2)2034-4648

■ CHEONG-JU PLANT

Cheong-Ju Plant #1, Song Jung Dong, Hung Duk Ku,
Cheong Ju, 361-720, Korea

■ Global Network

• LS Industrial Systems (Middle East) FZE >> Dubai, U.A.E.

Address: LOB 19 JAFZA VIEW TOWER Room 205, Jebel Ali Freezone P.O. Box 114216, Dubai, United Arab Emirates
Tel: 971-4-886 5360 Fax: 971-4-886-5361 e-mail: jungyongl@lsis.biz

• Dalian LS Industrial Systems Co., Ltd. >> Dalian, China

Address: No.15, Liaohexi 3-Road, Economic and Technical Development zone, Dalian 116600, China
Tel: 86-411-8273-7777 Fax: 86-411-8730-7560 e-mail: lixk@lsis.com.cn

• LS Industrial Systems (Wuxi) Co., Ltd. >> Wuxi, China

Address: 102-A, National High & New Tech Industrial Development Area, Wuxi, Jiangsu, 214028, P.R.China
Tel: 86-510-8534-6666 Fax: 86-510-522-4078 e-mail: xuhg@lsis.com.cn

• LS-VINA Industrial Systems Co., Ltd. >> Hanoi, Vietnam

Address: Nguyen Khe - Dong Anh - Ha Noi - Viet Nam
Tel: 84-4-882-0222 Fax: 84-4-882-0220 e-mail: srjo@lsisvina.com

• LS-VINA Industrial Systems Co., Ltd. >> Hochiminh, Vietnam

Address: 41 Nguyen Thi Minh Khai Str. Yoco Bldg 4th Floor, Hochiminh City, Vietnam
Tel: 84-8-3822-7941 Fax: 84-8-3822-7942 e-mail: sbpark@lsisvina.com

• LS Industrial Systems Tokyo Office >> Tokyo, Japan

Address: 16FL, Higashi-Kan, Akasaka Twin Tower 17-22, 2-chome, Akasaka, Minato-ku Tokyo 107-8470, Japan
Tel: 81-3-3582-9128 Fax: 81-3-3582-2667 e-mail: jschuna@lsis.biz

• LS Industrial Systems Shanghai Office >> Shanghai, China

Address: Room E-G, 12th Floor Huamin Empire Plaza, No.726, West Yan'an Road Shanghai 200050, P.R. China
Tel: 86-21-5237-9977 (609) Fax: 89-21-5237-7191 e-mail: jinhk@lsis.com.cn

• LS Industrial Systems Beijing Office >> Beijing, China

Address: B-Tower 17FL, Beijing Global Trade Center B/D. No.36, BeiSanHuanDong-Lu, DongCheng-District, Beijing 100013, P.R. China
Tel: 86-10-5825-6025,7 Fax: 86-10-5825-6026 e-mail: cuixiaorong@lsis.com.cn

• LS Industrial Systems Guangzhou Office >> Guangzhou, China

Address: Room 1403,14F,New Poly Tower,2 Zhongshan Liu Road,Guangzhou, P.R. China
Tel: 86-20-8326-6764 Fax: 86-20-8326-6287 e-mail: linsz@lsis.biz

• LS Industrial Systems Chengdu Office >> Chengdu, China

Address: Room 1701 17Floor, huanminhanjun international Building, No1 Fuxing Road Chengdu, 610041, P.R. China
Tel: 86-28-8670-3101 Fax: 86-28-8670-3203 e-mail: yangcf@lsis.com.cn

• LS Industrial Systems Qingdao Office >> Qingdao, China

Address: 7B40,Haixin Guangchang Shenye Building B, No.9, Shandong Road Qingdao 26600, P.R. China
Tel: 86-532-8501-6568 Fax: 86-532-583-3793 e-mail: lirj@lsis.com.cn

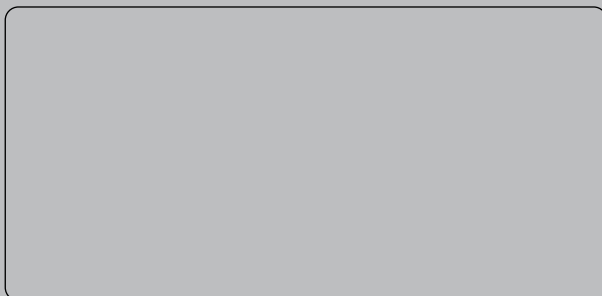

Specifications in this catalog are subject to change without notice due to continuous product development and improvement.