

Instruction Manual

LAMINAR ION BAR AMB-L Series

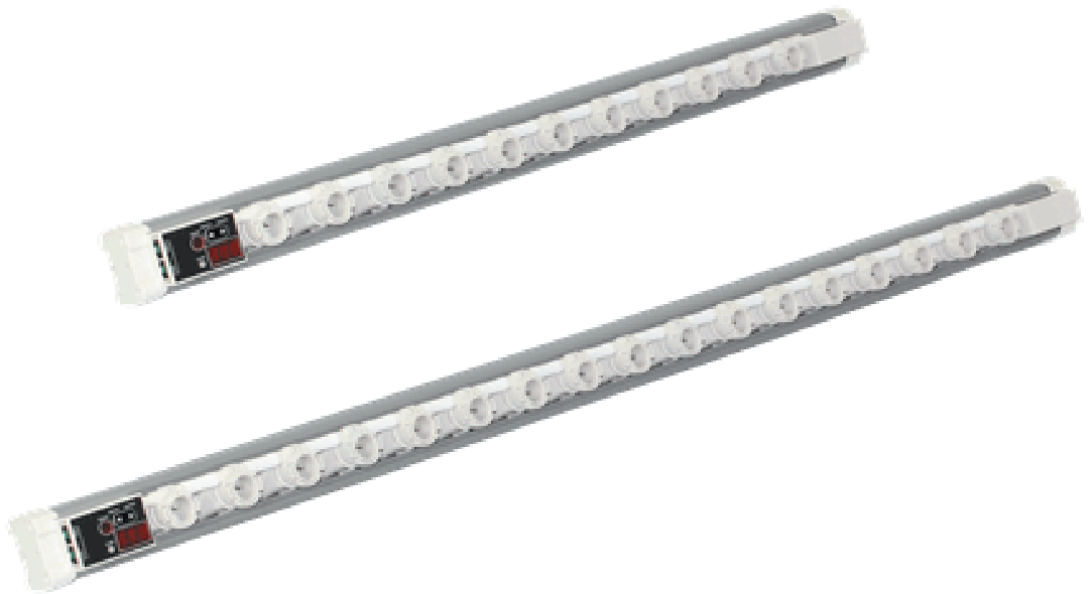

Read this instruction manual before using the product in order to achieve maximum performance.
Keep this instruction manual within your reach after reading so that it can be used at any time.

CONTENTS

1. Product Introduction

1.1 Features		03Page
1.3 Dimensions	1.2 Specification	
1.5 Package contents	1.4 Performance	
1.7 Cautions and warranty	1.6 Part names	

2. Installation & Connection

2.1 Installation location		08Page
2.3 Wiring diagram	2.2 Purging and moving into CR	
2.5 Connecting multi bars	2.4 Installing and connecting main body	
	2.6 Check list after installation	

3. Settings

3.1 Setting values		14Page
--------------------	--	--------

4. Maintenance

4.1 Necessity of the maintenance		16Page
	4.2 How to clean and replace an emitter	

APPENDIX		18Page
-----------------	--	--------

1.1 Trouble shooting		
----------------------	--	--

Before installation, be sure to read carefully at least

1.7 Cautions and Warranty (P.7)

2. Installation & Connection (P.8 ~ P.13)

1.1 Features

Welcome to become a customer of DIT!

AMB-L series is a bar ionizer which spreads ion using not clean dry air(CDA) but laminar flow of clean rooms. This product uses a process known as corona discharge to generate positive(+) and negative(-) air ions and neutralizes any static electric charge.

AMB-L Series is,

- More suitable for **room ionization**. For rapid static elimination in small space, we recommend our products using CDA.
- Safe from fire by using own piezo-ceramic for HVPS(High Voltage Power Supply).
- Able to keep stable Ion Balance due to its patented **Auto-Balancing function**.

1.2 Specifications

Series name	MB-L	Power consumption	MAX. 20W
Length	Min 250mm ~ max 1500 mm (increasing by 50mm)	Ozone generation	Under 0.005ppm
Ion generating method	Corona discharge	Material	Main body : ABS / Emitter pin
Voltage application method	Pulsed AC	Ambient temperature	0℃ ~ +50℃(32~122℉)
Input Voltage	DC24V±10%	Relative humidity	35~85%RH(No dewing)
Input Current	MAX. 300mA	Display	Alarm LED(Green/Red), 3-Digit(Error and Status display)
Output Voltage	6.5kV		
Output Frequency	0.5Hz ~10Hz (adjustable)	Controllable factors	Frequency, Ion on/off, Duty, Address, Communication speed, Password, Resetting,
Ion Balance	Under average ±30V		

※ Specification can be changed without notice for performance improvement.

1. 3 Dimensions

<AMB-L030>

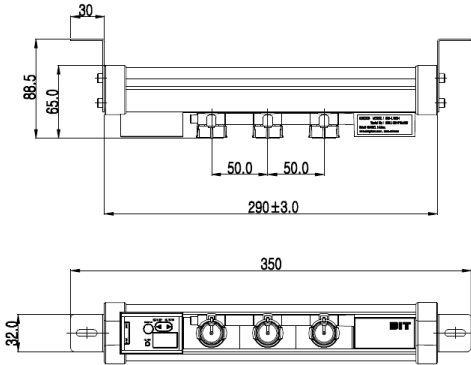

<Bracket>

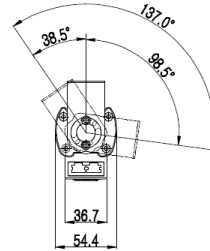

<AMB-L050>

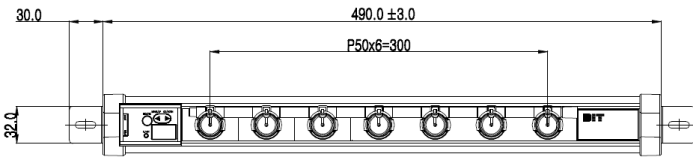

<AMB-L100>

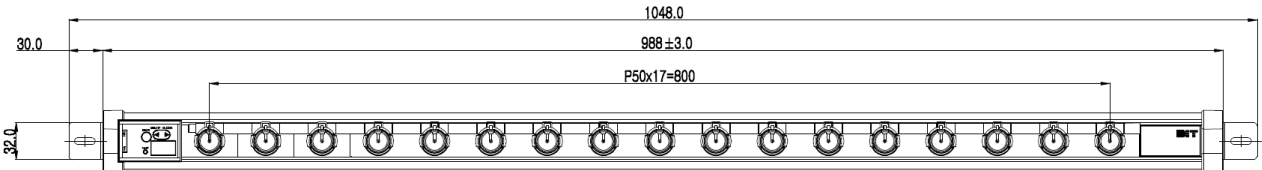

Model	Number of emitters(EA)	Length(mm)	Model	Number of emitters(EA)	Length(mm)
AMB-L025	2	240	AMB-L090	15	888
AMB-L030	3	290	AMB-L100	17	988
AMB-L040	5	390	AMB-L110	19	1087
AMB-L050	7	490	AMB-L120	21	1187
AMB-L060	9	589	AMB-L130	23	1286
AMB-L070	11	689	AMB-L140	25	1386
AMB-L080	13	788	AMB-L150	27	1486

1.4 Performance

- ※ Decay time(discharge time) : the time necessary for static elimination
- Relation between discharge time and distance(Distance-mm/discharge Time-sec) shows discharge time according to the distance measured in product's side and front perspective. (Place : DIT Test-Room)

Relation between Depth Direction and Decay Time

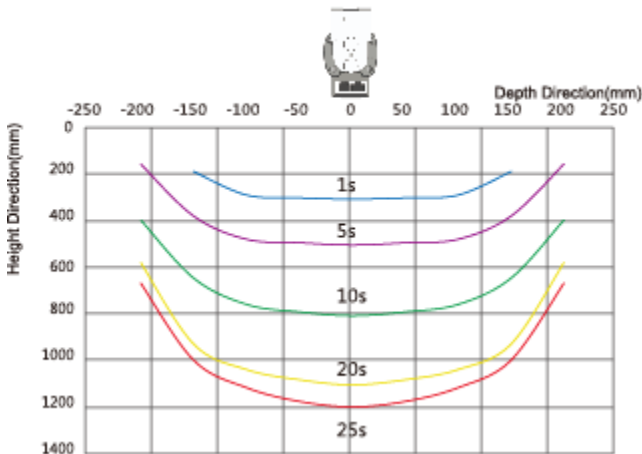

Down flow : 0.3m/s
 Capacity : 20pF
 Measurement condition : 1kV → 0.1kV
 Charged plate dimensions : 150mm x 150mm
 Frequency : 5Hz

Relation between Width Direction and Decay Time

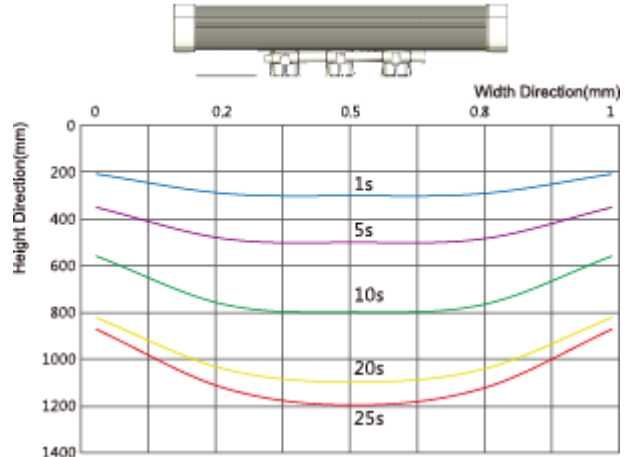

Down flow : 0.3M/s
 Capacity : 20pF
 Measurement condition : 1kV → 0.1kV
 Charged plate dimensions : 150mm x 150mm
 Frequency : 30Hz

- Relation between discharge time and frequency settings
 Discharge time is faster as the frequency is lower because more ion can reach to the mid-long distance. However, offset voltage is getting higher as the frequency is lower.

Relation between discharge time and frequency settings

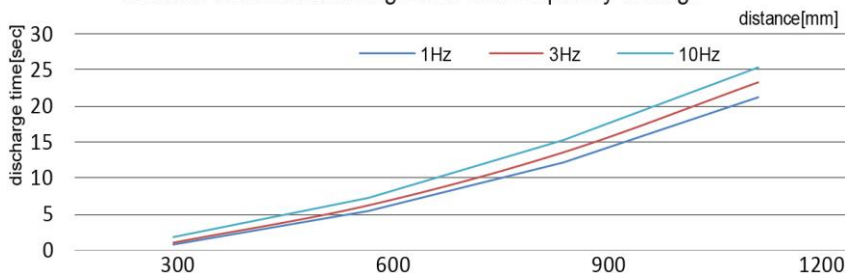

Down flow: 0.3m/s
 Charged plate dimensions:
 150 x 150 mm
 Measure condition: 1kV -> 0.1kV
 Capacitance: 20pF

1.5 Package Contents

< Package >

① Main body(controller & power supply embedded)

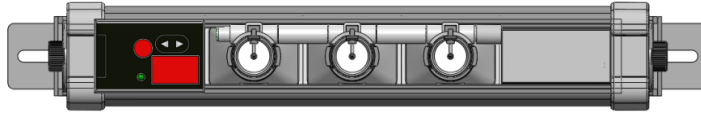

② Support brackets and screws



③ Power cable A (RJ-45[8PIN])



※ Contact to the seller for customizing

※ Length: 3M

< Options >

① Ion emitter Kit
For replacement
(10ea/set)



② Additional cable A/B
For daisy-chain



③ Remote Controlle



1.6 Part names

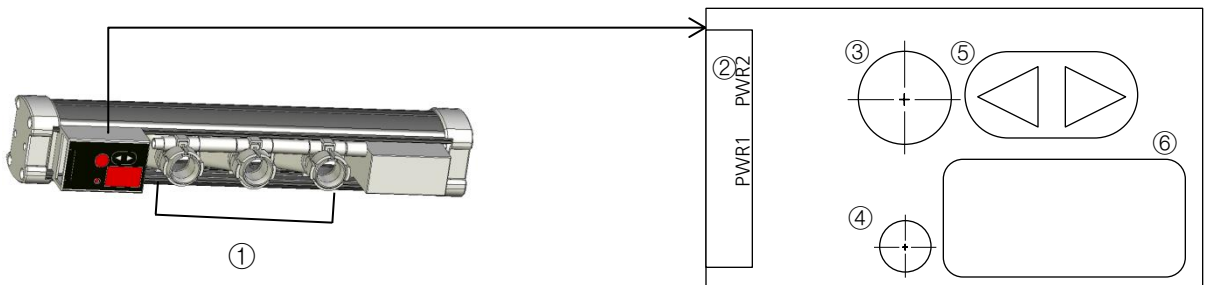

- ① Ion emitters
- ② RJ-45 Power cable connector [2Port / PWR1, PWR2]
- ③ Remote control receiver
- ④ Status Display LED
- ⑤ Menu Buttons (MENU/UP OK/DOWN)
- ⑥ DISPLAY

1.7 Cautions and warranty

Please be well informed of the cautions below before installation.

1) Safety

- To avoid the risk of electric shock or product malfunction, keep fingers and metallic objects away from the unit during operation.
- Make sure that there is adequate ventilation when using the Unit in an enclosed space because static elimination using Corona Discharge method generally generate a small quantity of ozone.
- To avoid the risk of electric shock, be sure to turn the power off during the maintenance.
- To avoid the risk of injury, do not touch the emitter pin directly with your hands.
- Disconnect from power supply and remove all the air in the unit before installing or moving.
- To avoid explosion, do not install the Unit in a place surrounded with volatile material or a lot of particles.

2) Power supply

- Use a DC power supply at voltage of 24V+-10%
- Be sure to use a stabilized DC power supply.

3) Installation

- Don't use any other parts not enclosed in the package.
- Do not install in regions affected by strong electric magnetic fields.
- Keep appropriate distance between two units to avoid mutual interference.
(Refer to 8page)

4) Air

- AMB-L Series does not need AIR(CDA) supply.
- Down-Flow in work places seriously affects on the performance of AMB-L Series. So, it should be installed at places with sufficient down-flow. If there are changes of air flow, the products may not keep stable performance.

Non-observance of the above and **Warning!!** in this manual may lead to injury or product malfunction. DIT doesn't take any responsibility for the damage if the Unit is used in a manner that differs from the specification in this manual or if the Unit is modified by yourself.

2.1 Installation Location

- Provide enough space between the static elimination bar and surrounding walls as shown in the figures below.

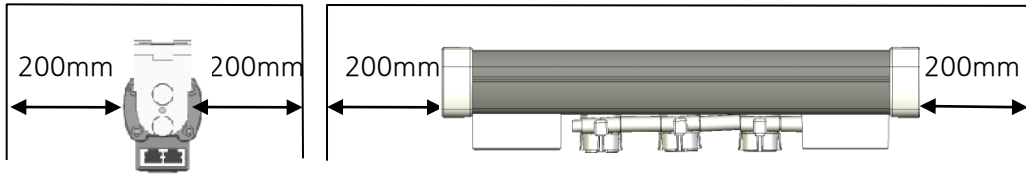

- If two AMB-L units are used, refer to the following illustration and separate the static elimination bars properly.

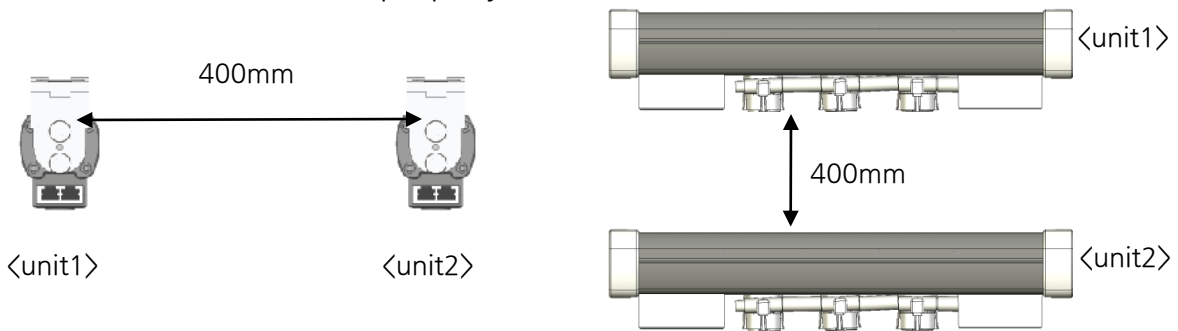

- Keep at least 20cm distance between the unit and the static charged object.

2.1 Installation Location

< Moving the Unit into CR(Clean Room) >











We recommend doing the below process before moving the Unit into a clean room.

- 1) Remove the wrapping paper outside the clean room.
 - 2) Clean the outside of the plastic wrap with cleansing solution.
 - 3) Moving the Unit into clean room using a pass box.
 - 4) Remove the plastic wrap before installation.
- ※ If you have your own process for Clean Class, you can apply it.

2.3 Wiring diagram

<Wiring Diagram>



PIN No.	Color	Connection & Usage	
①	Gray 	Communication TX(+)/RX(+) Signal	RS485 Communication
②	Black 	Power Supply Ground, Field Ground	For power supply
③	Brown 	Power Supply Ground, Field Ground	
④	Red 	+24 DC Power Supply	
⑤	Orange 	+24 DC Power Supply	
⑥	Yellow 	PLC Circuit +24DC Power Supply	PLC On/Off
⑦	Green 	PLC Circuit Ion Alarm Signal	
⑧	Blue 	PLC Circuit ON/OFF Signal	
⑨	Violet 	PLC Circuit Ground	
⑩	White 	Communication TX(-)/RX(-) Signal	RS485 Communication

※ AMB-L Series needs a RJ45 cable [10Pin]. When wiring, please be careful not to change the colors of the cable.

2.3 Wiring diagram

〈AMB-L Series PLC Circuit Diagram〉

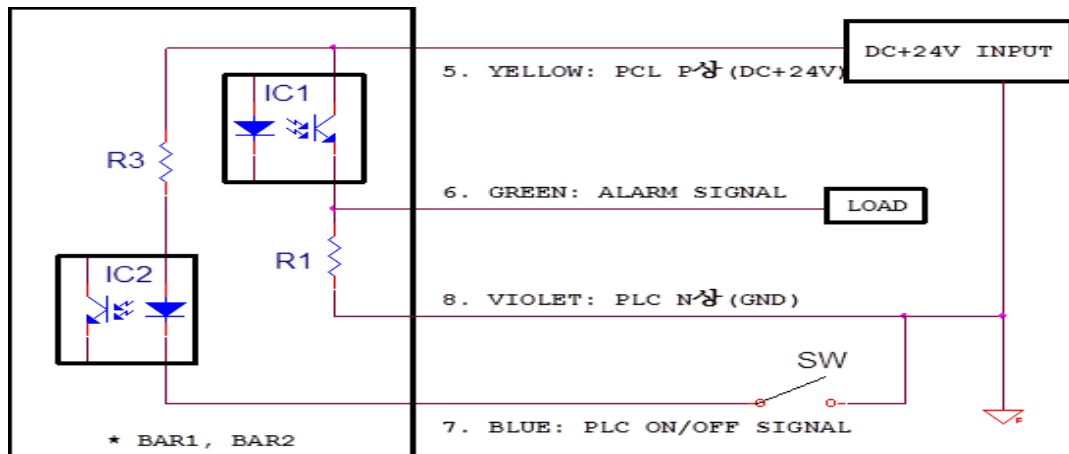

- Connection when not using PLC and RS-485
 - 1) Connect the black and brown cables to a power and field ground.
 - 2) Connect the red and orange cables to DC 24V.
 - 3) To avoid a short, cut the other cables shortly and tap them with deliberation.

- Connection when using PLC
 - 1) Connect the black, brown and violet cables to a power and field ground.
 - 2) Connect the red, orange and yellow cables to DC 24V.
 - 3) Connect the blue cable to the ground, the same point of black, brown and violet cables, which makes PLC work. If you open it, PLC doesn't work.
(Please refer to the AMB-L Series PLC Circuit Diagram below)
 - 4) The green cable is for an alarm signal
 - Normal condition: 0V output
 - Abnormal condition: 24V(20mA) output
 - Setting Load: Set the output current under 100mA

- Connection when using an adaptor
 - 1) Connect the black and brown cables to the adaptor (-). Make sure that either one of the cables should be connected to an earthed part of the machine.
 - 2) Connect the red and orange cables to the adaptor (+).
 - 3) To avoid a short, cut the other cables shortly and tap them with deliberation.

2.4 Installing and connecting main body

< Installation order >

- ① Assemble the brackets firmly into a main body.
 - ※ Upon the operating environment and the product's length, additional brackets can be needed.

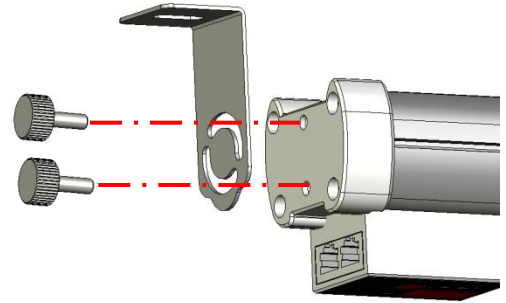

- ② Fix the main body with M6 screws.

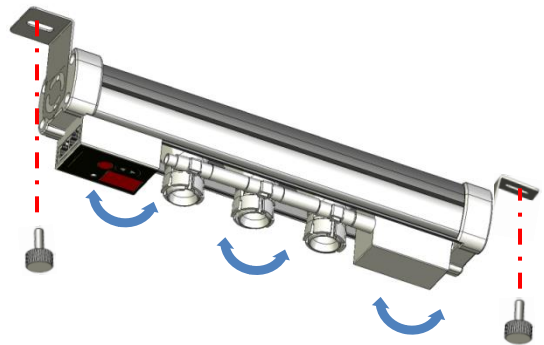

- ③ You can set the main body's angle according to the operating environment.

- ④ Connect power cable Connect RJ-45 power cable (A or B types) to PWR1 or PWR2 by pushing the cable until you hear "tic" sound.

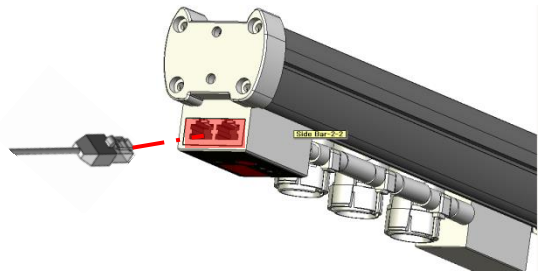

Warning!!

Make sure that you understand the Wiring Diagram(P.9) and make connections accordingly.

For guaranteed performance, make sure that GND cable of the power cable should be earthed.

2.5 Connecting multi bars (Daisy-Chain)

- Daisy-Chaining Method (Power/Communication)
 - What is “Daisy-Chain”?
 - . Power : Transfer electric power from one unit to an another unit.
 - ※ Up to four electric power units can be serially connected.
 - . Communication : Information from each unit can be integrated and controlled by assigning different addresses to each unit.
 - How to have multi bars daisy-chained?

As demonstrated below, power and communication are connected to <unit1> using RJ45-A type cable. Power and communication can be supplied to <unit2> from <unit1> by connecting them using RJ45-B type cable. Use PWR1 or PWR 2 to connect each units.

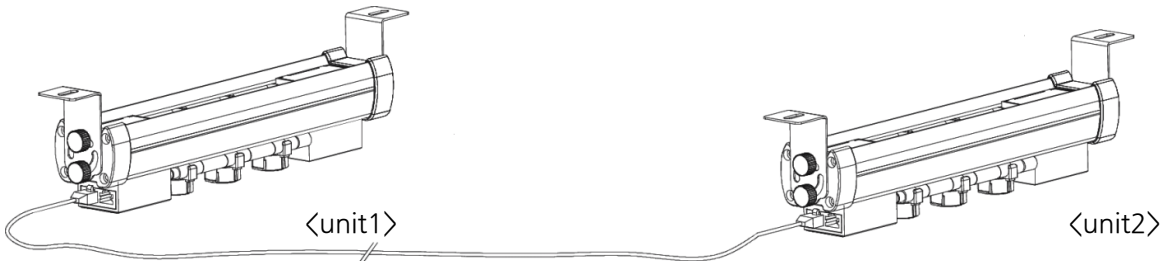

Warning!!

- . If you are using cables other than ones provided by us, please consult us or our agency.
- . If multiple bars are connected, make sure that sufficient power is supplied.









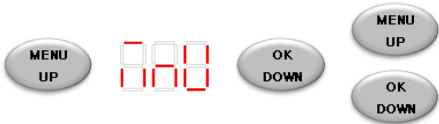
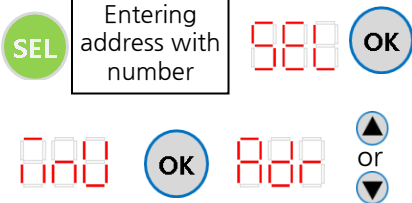

2. 6 Check list after installation

Recheck the below list before operating the unit.

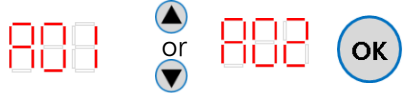
- (1) Make sure that power is properly connected. Check if proper amount of power is supplied to the unit. Excessive or deficient amount of power may cause damages to the device.
- (2) Check operation environment that may cause malfunction, failure or shorting the life of the device, such as strong magnetic or heat sources.
- (3) Check if there are any metallic objects in the vicinity of the device(within 5 cm) or within the operating distance. Metallic objects nearby hinder ion generation;
metallic objects within the operating distance block ion moving toward targets for static control.
- (4) Check if emitter is installed correctly. Operation without the emitter may seriously damage the device or cause malfunction of the device.
- (5) Check if the device is loaded with excessive weight or subject to shock. Excessive load or shock to the device may cause serious damage such as malfunction.

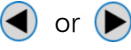
Our AMB-L Series is an ionization device using Corona Discharge method. Ion emission and ion balance are subject to operation environment, please make yourself familiar to the device, instruction, and cautions before using the device.

3. 1 How to set values

Operation	When using Key Panel	When using remote controller
<p>Entering Menu mode and finding an option</p>	 <p>Press "Menu" key: "MnU" is displayed on the panel. Press OK to enter the main Menu. Use "UP", "DOWN" keys to find a specific menu option that you need.</p>	 <p>Entering address with number</p> <p>After entering the right address, "SEL" is displayed on the panel. Press "OK" key, then, "MnU" is displayed on the panel. Press "OK" one more time to enter the main Menu. Use "▲" or "▼" to find a specific menu option that you need.</p>
<p>Entering a specific menu option (Ex: Address setting)</p>	 <p>2 seconds</p> <p>Hold "OK" for 2 seconds when the panel displays 3 characters of each menu(ex:"Adr"). You can see the previous setting value on display.</p>	 <p>Hold "OK" when the panel displays 3 characters of each menu(ex:"Adr"). You can see the previous setting value on display.</p>
<p>Setting and saving a value</p>	 <p>2 seconds</p> <p>Use "UP", "DOWN" keys to change the value and press "OK" for 2 seconds to save the changed value.</p>	 <p>Use "▲" or "▼" to change the value and press "OK" to save the changed value.</p>
<p>Switching digits</p>	 <p>and</p>  <p>Press "UP" and "DOWN" keys together, and move to next digit. After the panel light blinks, use "UP" or "DOWN" keys to make changes.</p>	 <p>or</p>  <p>Press "◀" or "▶" to move to next digit. After the panel light blinks, use "▲" or "▼" to make changes.</p>
<p>Returning to initial Menu mode</p>	 <p>2 seconds</p> <p>Press "MENU" for more than 2 seconds to return to initial Menu mode. Press "MENU" one more time to return to a standby mode.</p>	 <p>Press "ESC" to return to initial Menu mode. Press "ESC" one more time to return to a standby mode</p>

3. 2 Explanation on menu options

Menu	Explanation	Notes
Adr	Setting Address	Assigning "A01" - "A63" is allowed (up to 63 units). If there are duplicated addresses, controlling the system with a remote controller may result in false operation by controlling a wrong unit.
Ion	Ion On/Off	When ion output sets "oFF", alarm LED changes to red and "Er1" is displayed on the panel.
FrE:	Setting Frequency	Frequency output may range from 0.5 to 10.0.(Hz) "0.5 ~ 1.0" : adjustment possible by 0.1 (increase/decrease) "1.0 ~ 10.0" : adjustment possible by 1.0 (increase/decrease)
bAL	Setting Ion Balance	Ion balance may range from 35.0 to 65.0.(% of positive ions)
tIP	Setting Emitter Pin Cleaning Period	If "Yes" is chosen to start cleaning cycle, "Er3" is displayed when the end of cleaning cycle is reached. Once the pins are cleaned, reset the cleaning cycle. Cleaning cycle can be increase by week (one week as a unit); t01w~t52w.
PAS	Setting Password	When the password is on, you need to enter the right password to enter the main "Menu" for a new password setup. Password can be a three digit number, any number between 000 and 999.
SPd	Setting Communication Speed	Communication Speed is measured in BPS(bit per second) Selection can be made among seven speeds shown below. 2.4k / 4.8k / 9.6k / 19.2k / 38.4k / 57.6k / 115k
Int:	Restoring initial factory settings	Factory setup is as follows. Adr : "A01" Ion : " on" FrE : "3.0" voL : "L-4" bAL : "50.0" PAS : "oFF" SPd : " 9.6" tIP : "no"

4. 1 Necessity of maintenance

- Necessity of emitter pin cleaning and emitter replacement

In general, when ionizers are continuously in operation for a long period, dust and dirt are accumulated around the emitter pin, called “fuzzy-ball”.

Depending on operating environment, ‘fuzzy-ball’ grows to block normal operation and results in deterioration in performance of ionizers.

An emitter pin (inside a emitter) is a sharp, pin-shaped object, made from tungsten. AMB-L Series produces ions using Corona Discharge method. Thus, during an operation, high voltage is applied on its emitter pin, which rounds the sharp pin away as the time goes on. A rounded emitter pin cannot produce ion as well as the sharp one.

For these reasons, emitter and emitter pin should be cleaned and replaced periodically.

If not cleaned, and replaced properly, worn-out emitter pin with fuzzy-balls, may deteriorate the quality and performance of your production. Make sure that emitter (and emitter pin) should be cleaned and replaced on a regular basis.

- Recommended cleaning cycle under the circumstance below : **Every 2 months**

. Temperature : 22 °C[a higher temperature may lengthen the cycle]

. Humidity : 50%[a higher humidity may lengthen the cycle]

. Clean Class : 10,000 Class [a lower Class index may lengthen the cycle]

※ The conditions listed above are for general environment, Actual result may slightly vary depending on the user’s working environment.

2 months cleaning cycle is based on test conditions used by DIT. Please compare DIT’s conditions and your working environment and adjust it and set up cleaning cycle accordingly.

4. 2 How to clean and replace emitters

- How to clean an emitter

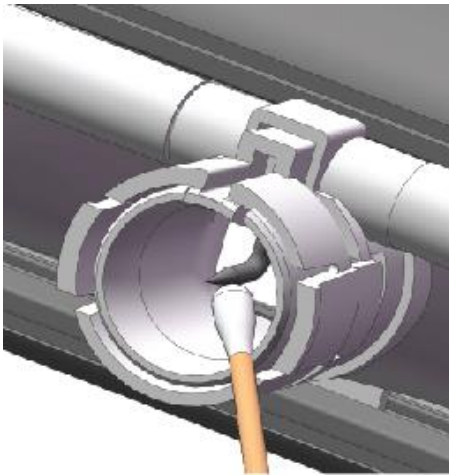

- ① Prepare soft brush or cotton swab with alcohol. (No acetone)
- ② Power off the device.
- ③ Wipe out the white 'Fuzzy ball' on the end of the emitter pin softly enough not to damage or scratch it.
- ④ Power on the device.
- ⑤ After 5 ~ 10 minutes, check the device performance with and measuring instrument.

- How to replace an emitter

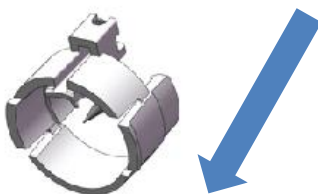
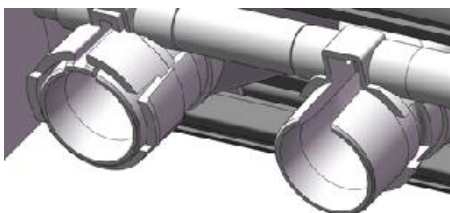
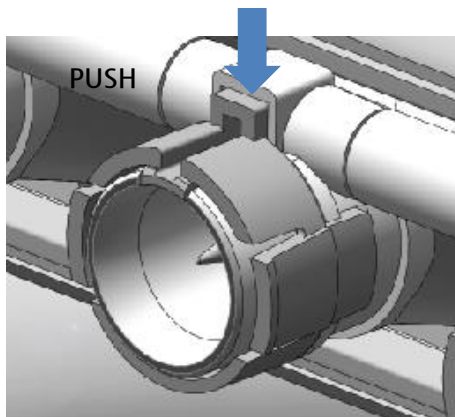

- ① Prepare a new emitter for replacement.
- ② Power off the device.
- ③ Push the emitter assembled in the unit. (Refer to the left side image)
- ④ Pull out the emitter to separate it from the unit.
- ⑤ Insert a new emitter and assemble to fix it firmly. (press into bottom of the hole)
- ⑥ Power on the device.
- ⑦ After 5 ~ 10 minutes, check the device performance with and measuring instrument.

Trouble Shooting

Problems	Check Points
FND is not displayed	<ol style="list-style-type: none"> 1) Check that the power cable is connected correctly. 2) When it dose not work even though the cable connection is correct, contact to our sales agent.
Alarm LED is blinking in red	<ol style="list-style-type: none"> 1) Enter the MENU using keys or a remote controller. 2) Enter "Ion" menu and check that Ion is ON. 3) When using PLC, check that PLC is ON. 4) When it dose not work even though all settings are on, contact to our sales agent.
Ion balance is swing between + and -	<ol style="list-style-type: none"> 1) Some swing is natural because of Auto Balancing function. 2) Clean the emitter pin or replace the emitter. 3) If it is the same even after cleaning or replacing the emitters, contact to our sales agent.
Slight unknown smell during operation	Normal state caused by high voltage discharge.
Smell of burning during operation	<ol style="list-style-type: none"> 1) Turn off the power immediately. 2) Contact to our sales agent.
Remote controller doesn't work	<ol style="list-style-type: none"> 1) Check and change the battery. 2) Check the distance between the unit and the remote controller (Max 2.5M). 3) Check the unit address.
Error message is displayed on FND	<ol style="list-style-type: none"> 1) Er1 : Ion off error. Turn Ion on at Ion menu. 2) Er2 : HVPS/Circuit error. Contact to sales agent or manufacturer. 3) Er3 : Emitter pin cleaning alarm message. Reset the pin cleaning period after cleaning.

※ If you cannot solve the problem with the direction above or have other problems not described above, please call the manufacturer or leave a message on our website(www.dongiltech.co.kr).

Quality assurance team : 82.31.299.5466

Warranty

We, Dong Il Technology Ltd. Manufactured this product under a strict quality control system and warrants it for 1 year of period from the shipment date.

However, we don't have any responsibility for

- 1) Any damage if the product is used in a way different from that is explained in this manual or remade by users arbitrarily.
- 2) Any damage led by improper usage. We recommend the installation circumstances in this manual, but that is just a recommendation and users are responsible for understanding the product's specification and judgment of suitability of usage.
- 3) Direct or indirect damage led by the product malfunction.