

Rectangular Inductive Long-Distance Proximity Sensors



AS Series (DC 4-wire)

For your safety, read and follow the considerations written in the instruction manual, other manuals and Autonics website.

The specifications, dimensions, etc. are subject to change without notice for product improvement. Some models may be discontinued without notice.

Major Features

- Excellent noise immunity with specialized sensor IC
- Built-in surge protection circuit, output short over current protection circuit, reverse polarity protection
- Power supply : 12-48 VDC \equiv (operating voltage : 10-65 VDC \equiv)
- Simultaneous output (Normally Open + Normally Closed)
- Power indicator (green LED) and operation indicator (red LED)
- IP67 protection structure (IEC standard)

Safety Considerations

- Observe all 'Safety Considerations' for safe and proper operation to avoid hazards.
- \triangle symbol indicates caution due to special circumstances in which hazards may occur.

\triangle Warning Failure to follow instructions may result in serious injury or death.

- 01. Fail-safe device must be installed when using the unit with machinery that may cause serious injury or substantial economic loss. (e.g. nuclear power control, medical equipment, ships, vehicles, railways, aircraft, combustion apparatus, safety equipment, crime/disaster prevention devices, etc.)**
Failure to follow this instruction may result in personal injury, economic loss or fire.
- 02. Do not use the unit in the place where flammable/explosive/corrosive gas, high humidity, direct sunlight, radiant heat, vibration, impact, or salinity may be present.**
Failure to follow this instruction may result in explosion or fire.
- 03. Do not disassemble or modify the unit.**
Failure to follow this instruction may result in fire.
- 04. Do not connect, repair, or inspect the unit while connected to a power source.**
Failure to follow this instruction may result in fire.
- 05. Check 'Connections' before wiring.**
Failure to follow this instruction may result in fire.

\triangle Caution Failure to follow instructions may result in injury or product damage.

- 01. Use the unit within the rated specifications.**
Failure to follow this instruction may result in fire or product damage.
- 02. Use a dry cloth to clean the unit, and do not use water or organic solvent.**
Failure to follow this instruction may result in fire.

Cautions during Use

- Follow instructions in 'Cautions during Use'. Otherwise, it may cause unexpected accidents.
- 12-48 VDC \equiv power supply should be insulated and limited voltage/current or Class 2, SELV power supply device.
- Use the product, after 0.8 sec of supplying power.
- Wire as short as possible and keep away from high voltage lines or power lines, to prevent surge and inductive noise. Do not use near the equipment which generates strong magnetic force or high frequency noise (transceiver, etc.).
In case installing the product near the equipment which generates strong surge (motor, welding machine, etc.), use diode or varistor to remove surge.
- This unit may be used in the following environments.
 - Indoors (in the environment condition rated in 'Specifications')
 - Altitude max. 2,000 m
 - Pollution degree 2
 - Installation category II

Cautions for Installation

- Install the unit correctly with the usage environment, location, and the designated specifications.
- Do NOT impacts with a hard object or excessive bending of the wire lead-out. It may cause damage the water resistance.
- Do NOT pull the \varnothing 2.5 mm cable with a tensile strength of 20 N, the \varnothing 4 mm cable with a tensile strength of 30 N or over and the \varnothing 5 mm cable with a tensile strength of 50 N or over. It may result in fire due to the broken wire.
- When extending wire, use AWG 22 cable or over within 200 m.
- Tighten the installing screws with under 1.47 N m torque.

Ordering Information

This is only for reference.

For selecting the specific model, follow the Autonics web site.

AS 80 - 50 D ①

① Control output

N3: NPN Normally Open + Normally Closed

P3: PNP Normally Open + Normally Closed

Product Components

- Bracket × 1
- M5 Bolt × 4

Connections

■ Cable type

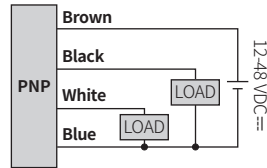
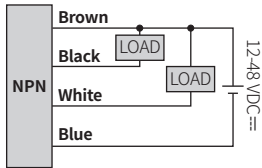

■ Inner circuit (NPN output)

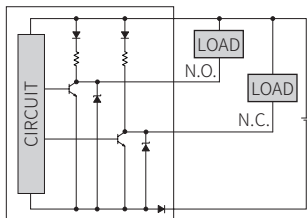

■ Inner circuit (PNP output)

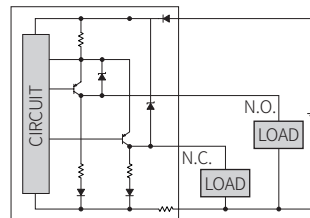

Specifications

Installation	Upper side type
Model	AS80-50D □
Sensing side length	80 mm
Sensing distance	50 mm
Setting distance	0 to 35 mm
Hysteresis	≤ 15 % of sensing distance
Standard sensing target: iron	150 × 150 × 1 mm
Response frequency⁰¹⁾	30 Hz
Affection by temperature	± 10 % for sensing distance at ambient temperature 20 °C
Indicator	Power indicator (green), operation indicator (yellow)
Approval	CE ENEC
Unit weight	≈ 470 g

01) The response frequency is the average value. The standard sensing target is used and the width is set as 2 times of the standard sensing target, 1/2 of the sensing distance for the distance.

Power supply	12-48 VDC≒ (ripple P-P: ≤ 10 %), operating voltage: 10-65 VDC≒
Current consumption	≤ 20 mA
Control output	≤ 200 mA
Residual voltage	≤ 2 V
Protection circuit	Surge protection circuit, output short over current protection circuit, reverse polarity protection
Insulation type	≥ 50 MΩ (500 VDC≒ megger)
Dielectric strength	1,500 VAC~ 50/60 Hz for 1 minute
Vibration	1 mm amplitude at frequency 10 to 55 Hz (for 1 min) in each X, Y, Z direction for 2 hours
Shock	500 m/s ² (≈ 50 G) X, Y, Z directions for 3 times
Ambient temperature	-25 to 70 °C, storage: -30 to 80 °C (non-freezing or non-condensation)
Ambient humidity	35 to 95 %RH, storage: 35 to 95 %RH (non-freezing or non-condensation)
Protection structure	IP67 (IEC standards)
Connection	Cable type model
Wire spec.	Ø 5 mm, 4-wire, 2 m
Connector spec.	AWG 22 (0.08 mm, 60-wire), insulator diameter: Ø 1.25 mm
Material	Case: PC+ABS, standard type cable (black): polyvinyl chloride (PVC)

Operation Timing Chart

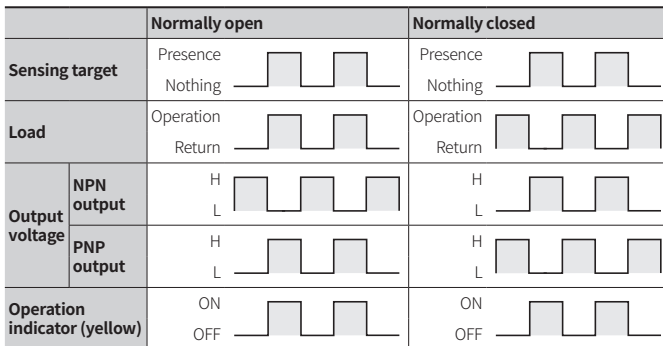

Dimensions

• Unit: mm, For the detailed dimensions of the product, follow the Autonics web site.

A Tap hole

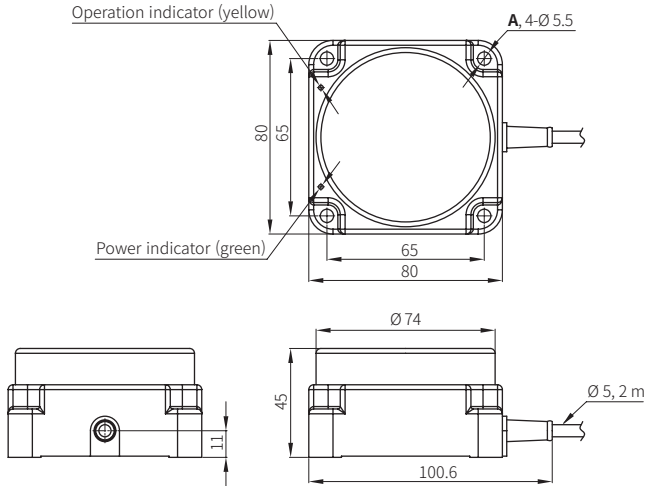

Sensing Distance Feature Data by Target Material and Size

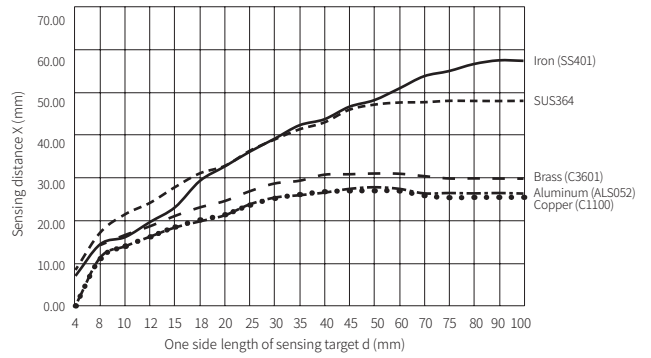
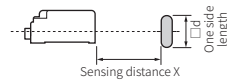

Setting Distance Formula

Detecting distance can be changed by the shape, size or material of the target.

For stable sensing, install the unit within the 70% of sensing distance.

Setting distance (Sa)

= Sensing distance (Sn) × 70%

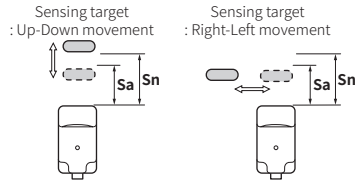

Sensing Distance Feature Data by Parallel (Left/Right) Movement

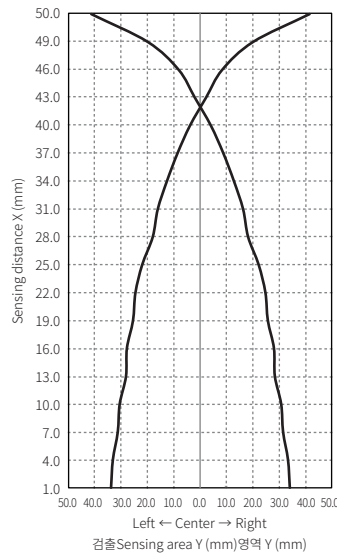
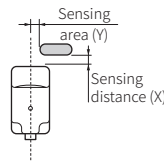

Mutual-interference & Influence by Surrounding Metals

■ Mutual-interference

When plural proximity sensors are mounted in a close row, malfunction of sensor may be caused due to mutual interference.

Therefore, be sure to provide a minimum distance between the two sensors, as below table.

A	320 mm	B	320 mm
----------	--------	----------	--------

[Face to Face]



[Parallel]

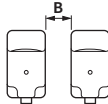

■ Differential frequency

When sensors are mounted on metallic panel, it must be prevented sensors from being affected by any metallic object except target. Therefore, be sure to provide a minimum distance as below chart.

d	150 mm	m	80 mm
----------	--------	----------	-------

