

Autonics

Melody Buzzer B6MA SERIES

INSTRUCTION MANUAL



Thank you for choosing our Autonics product.
Please read the following safety considerations before use.

■ Safety Considerations

※Please observe all safety considerations for safe and proper product operation to avoid hazards.

※⚠ symbol represents caution due to special circumstances in which hazards may occur.

⚠ Warning Failure to follow these instructions may result in serious injury or death.

⚠ Caution Failure to follow these instructions may result in personal injury or product damage.

⚠ Warning

1. **Fail-safe device must be installed when using the unit with machinery that may cause serious injury or substantial economic loss.** (e.g. nuclear power control, medical equipment, ships, vehicles, railways, aircraft, combustion apparatus, safety equipment, crime/disaster prevention devices, etc.)
Failure to follow this instruction may result in fire, personal injury, or economic loss.

2. **Do not disassemble or modify the unit.**
Failure to follow this instruction may result in fire.

3. **Do not use the unit close to the ear.**
Failure to follow this instruction may result in personal injury.

⚠ Caution

1. **Do not use the unit outdoors.**
Failure to follow this instruction may result in shorten the life cycle of the unit

2. **Use the unit within the rated specifications.**
Failure to follow this instruction may result in fire or product damage.

3. **When connecting the power input, use AWG 26-16 (0.30 to 1.25mm²) cable and tighten the terminal screw with a tightening torque of 0.4 to 0.6N·m.**
Failure to follow this instruction may result in fire or malfunction due to contact failure.

4. **Use dry cloth to clean the unit, and do not use water or organic solvent.**
Failure to follow this instruction may result in electric shock or fire.

5. **Do not use the unit in the place where flammable/explosive/corrosive gas, high humidity, direct sunlight, radiant heat, vibration, impact, or salinity may be present.**
Failure to follow this instruction may result in fire or explosion.

■ Ordering Information

B 6 MA - 4 G D N

Input	N	NPN open collector input
	P	PNP open collector input
Power supply	D	12-24VDC
	L	110-220VAC 50/60Hz
Case color	G	Gray
No. of channels	4	4 channels
Product name	MA	Melody alarm
Mounting hole	6	∅66
Item	B	Buzzer

※The above specifications are subject to change and some models may be discontinued without notice.

※Be sure to follow cautions written in the instruction manual and the technical descriptions (catalog, homepage).

■ Specifications

Model	B6MA-4GD	B6MA-4GL
Power supply	12-24VDC	110-220VAC
Allowable voltage range	90 to 110% of rated voltage	
Power consumption	Max. 3W	Max. 5VA
Input type	NPN open collector, PNP open collector	
Sound pressure	Max. 105±10%dB (0.1m), Max. 95dB±10% (1m)	
No. of channels	4 channels	
Melody type	Terminal input: 4 types (ambulance, police, ringtone, for elise)	
Insulation resistance	Min. 1,000MΩ (at 500VDC megger between all terminals and case)	
Dielectric strength	500VAC 50/60Hz for 1 min. (between all terminals and case)	2000VAC 50/60Hz for 1 min. (between all terminals and case)
Vibration	0.75mm amplitude at frequency of 10 to 55Hz (for 1 min.) in each of X, Y, Z directions for 2 hours	
Shock	500m/s ² (approx. 50G) in each X, Y, Z direction for 3 times	
Environ	Ambient temperature -10 to 55°C, storage: -20 to 65°C	
ment	Ambient humidity 35 to 85%RH, storage: 35 to 85%RH	
Protection	IP65 (front, IEC standards)	
Material	PC	
Screw tightening torque for power input terminals	0.4 to 0.6N·m	
Nut tightening torque for panel mounting	0.7 to 0.8N·m	
Accessory	Flat washers: 4, Spring washers: 4, Hex nuts: 4	
Approval	CE	
Weight ^{※1}	Approx. 170g (approx. 130g)	

※1: The weight includes packaging. The weight in parentheses is for unit only.
※Environment resistance is rated at no freezing or condensation.

■ Dimensions

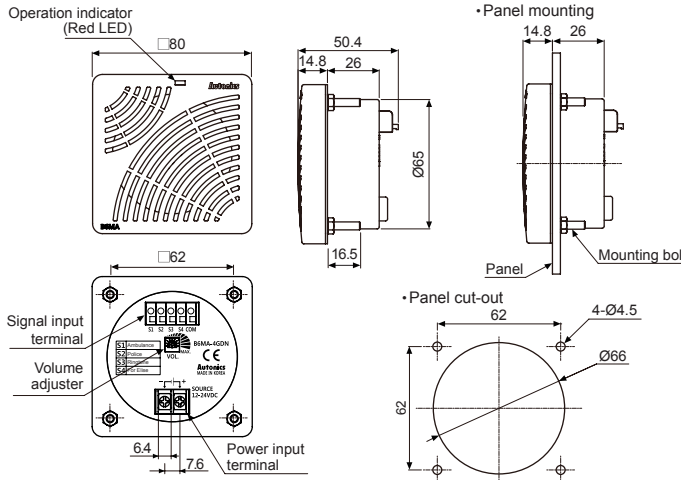

■ Connections

• Power input terminal

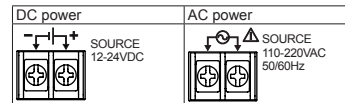

• Signal input terminal

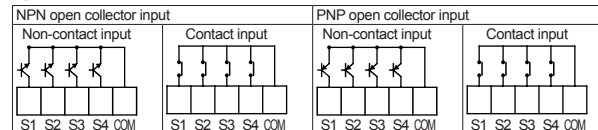

※Do not supply the power to the signal input terminals. Failure to follow this instruction may result in input circuit damage or malfunction of the unit.

■ How To Select Melody Type

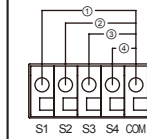

No.	Terminals	Melody type
①	COM-S1	Ambulance
②	COM-S2	Police
③	COM-S3	Ringtone
④	COM-S4	For Elise

Connect the COM terminal and the desired melody type terminal using the crimp terminals.

※You may sample the melodies at www.autonics.com.

■ Applicable Crimp Terminals

• Power input crimp terminals

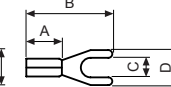
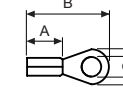

• Signal input crimp terminals

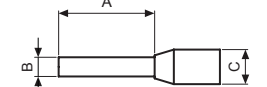

		A	B	C	D	Applicable wires
Power input crimp terminal	Forked	Min. 4.1	Max. 16.0	Min. 3.0	Max. 5.9	AWG 22-16 (0.30 to 1.25mm ²)
	Round	Min. 4.1	Max. 16.0	Min. 3.0	Max. 5.9	
Signal input crimp terminal	End Sleeve (Ferrule Terminal) crimp terminal	8.0 to 10.0	Max. 2.0	Max. 4.1	—	

■ Installation

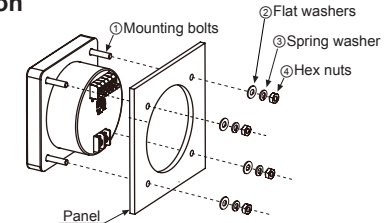

• Assembly sequence

1. Insert the mounting bolts (1) of the unit to the panel mounting holes.
2. Assemble the flat washers (2), the spring washers (3), and tighten the hex nuts (4) to fix the unit on the panel.

■ Caution During Use

1. Follow instructions in Cautions during Use. Otherwise, it may cause unexpected accidents.
2. 12-24VDC power supply should be insulated and limited voltage/current or Class 2, SELV power supply device.
3. Keep away from high voltage lines or power lines to prevent inductive noise. In case installing power line and input signal line closely, use line filter or varistor at power line and shielded wire at input signal line. Do not use near the equipment which generates strong magnetic force or high frequency noise.
4. This unit may be used in the following environments.
 - ① Indoor (in the environment conditions in specifications)
 - ② Altitude max. 2,000m
 - ③ Pollution degree 2
 - ④ Installation category II

■ Major Products

- Photoelectric Sensors
- Fiber Optic Sensors
- Door Sensors
- Door Side Sensors
- Area Sensors
- Proximity Sensors
- Pressure Sensors
- Rotary Encoders
- Connector/Sockets
- Switching Mode Power Supplies
- Control Switches/Lamps/Buzzers
- I/O Terminal Blocks & Cables
- Stepper Motors/Drivers/Motion Controllers
- Graphic/Logic Panels
- Field Network Devices
- Laser Marking System (Fiber Co., Nd:Yag)
- Laser Welding/Soldering System
- Temperature Controllers
- Temperature/Humidity Transducers
- SSR/Power Controllers
- Counters
- Timers
- Panel Meters
- Tachometer/Pulse (Rate)Meters
- Display Units
- Sensor Controllers

Autonics Corporation
<http://www.autonics.com>

■ HEAD QUARTERS:
18, Bansong-ro 513beon-gil, Haeundae-gu, Busan, South Korea, 48002
TEL: 82-51-519-3232
E-mail: sales@autonics.com