

Photoelectric Sensors with Built-in Timer



BYD Series PRODUCT MANUAL

For your safety, read and follow the considerations written in the instruction manual, other manuals and Autonics website.

The specifications, dimensions, etc. are subject to change without notice for product improvement. Some models may be discontinued without notice.

Features

- Easy installation by compact size
- Superior detection not affected by color of target (convergent reflective type)
- Operation indicator is located on the top (BYD30-DDT-U, BYD50-DDT-U)
- Easy to adjust the response time via timer function (OFF Delay Time: 0.1 to 2 sec)
- Reverse power protection circuit, output short overcurrent protection circuit

Safety Considerations

- Observe all 'Safety Considerations' for safe and proper operation to avoid hazards.
- ⚠ symbol indicates caution due to special circumstances in which hazards may occur.

⚠ Warning Failure to follow instructions may result in serious injury or death.

- 01. Fail-safe device must be installed when using the unit with machinery that may cause serious injury or substantial economic loss. (e.g., nuclear power control, medical equipment, ships, vehicles, railways, aircraft, combustion apparatus, safety equipment, crime/disaster prevention devices, etc.)**
Failure to follow this instruction may result in personal injury, economic loss or fire.
- 02. Do not use the unit in the place where flammable/explosive/corrosive gas, high humidity, direct sunlight, radiant heat, vibration, impact or salinity may be present.**
Failure to follow this instruction may result in explosion or fire.
- 03. Do not disassemble or modify the unit.**
Failure to follow this instruction may result in fire.
- 04. Do not connect, repair, or inspect the unit while connected to a power source.**
Failure to follow this instruction may result in fire.
- 05. Check 'Connections' before wiring.**
Failure to follow this instruction may result in fire.

⚠ Caution Failure to follow instructions may result in injury or product damage.

- 01. Use the unit within the rated specifications.**
Failure to follow this instruction may result in fire or product damage.
- 02. Use a dry cloth to clean the unit, and do not use water or organic solvent.**
Failure to follow this instruction may result in fire.

Cautions during Use

- Follow instructions in 'Cautions during Use'. Otherwise, It may cause unexpected accidents.
- When connecting an inductive load such as DC relay or solenoid valve to the output, remove surge by using diodes or varistors.
- Use the product after 0.5 sec of the power input.
When using a separate power supply for the sensor and load, supply power to the sensor first.
- 12-24 VDC= power supply should be insulated and limited voltage/current or Class 2, SELV power supply device.
- Wire as short as possible and keep it away from high voltage lines or power lines to prevent surge and inductive noise.
- When using switching mode power supply (SMPS), ground F.G. terminal and connect a condenser between 0V and F.G. terminal to remove noise.
- When using a sensor with a noise-generating equipment (e.g., switching regulator, inverter, and servo motor), ground F.G. terminal of the equipment.
- This unit may be used in the following environments.
 - Indoors (in the environment condition rated in 'Specifications')
 - Altitude max. 2,000 m
 - Pollution degree 3
 - Installation category II

Product Components

Sensing type	Through-beam	Diffuse reflective	Convergent reflective
Product components	Product, instruction manual		
Adjustment screwdriver	-	× 1	× 1
Bracket A	× 2	× 1	× 1
M3 bolt / nut	× 4	× 2	× 2

Ordering Information

This is only for reference, the actual product does not support all combinations. For selecting the specified model, follow the Autonics website.

BYD ① - ② **D T** - ③ - ④

① Sensing distance

Number: Sensing distance (unit: mm)
Number+M: Sensing distance (unit: m)

② Sensing type

T: Through-beam
D: Diffuse reflective
D: Convergent reflective

③ Control output

No mark: NPN open collector output
P: PNP open collector output
(Through-beam type)

④ Feature of convergent reflective type

No mark: Front operation indicator
U: Upper operation indicator
T: Built-in timer (OFF delay mode)

Sold Separately

- Bracket B
- Slit for through-beam type: BYD3M-ST (sticker)

Cautions during Installation

- Be sure to install this product by following the usage environment, location, and specified ratings. Consider the listed conditions below.
 - Installation environment and background (reflected light)
 - Sensing distance and sensing target
 - Direction of target's movement
 - Feature data
- When installing multiple sensors closely, it may result in malfunction due to mutual interference.
- For installation, tighten the screw with a torque of 0.5 N m. Mount the brackets correctly to prevent the twisting of the sensor's optical axis.
- Do not impact with a hard object or bend the cable excessively. That could decrease the product's water resistance.
- Use this product after the test. Check whether the indicator works appropriately for the positions of the detectable object.

Through-beam	Reflective
Emitter - Receiver: Install to face each other	Sensor - Sensing target: Install to face each other (parallel with the sensing side of the unit)

Timer Setting

- In case of the built-in timer model, you can set the OFF Delay timer. (adjustable time: 0.1 to 2 sec)
- Use the offered adjustment screwdriver. Do NOT turn with excessive force to prevent product damage.



Operation Timing Chart

Standard type

Operation mode	Light ON	Dark ON
Received light	Received	Received
	Interrupted	Interrupted
Operation indicator (red)	ON	ON
	OFF	OFF
Transistor output	ON	ON
	OFF	OFF

- In case of the through-beam type, to prevent malfunction, output of units keeps the state of OFF for 0.5 sec after power ON.

Built-in timer type

Operation mode	Light ON
Received light	Received
	Interrupted
Operation indicator (red)	ON
	OFF
Transistor output	ON
	OFF

- T: Setting time by the adjuster (setting time: 0.1 to 2 sec)
- t: ≤ 3 ms (When the adjuster is set to Min (0.1 sec))
- If the interrupted time (Ta) after receiving the light is shorter than the setting time (T), the transistor output maintains the ON state.

Connections

Emitter

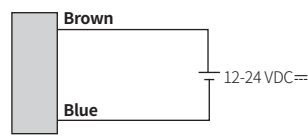

Receiver, Diffuse reflective, Convergent reflective type

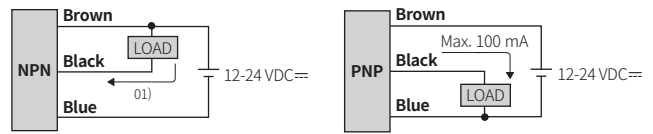

01) Through-beam type: max. 100 mA, diffuse reflective or convergent reflective type: max. 50 mA

Circuit

NPN open collector output

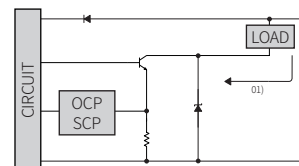

PNP open collector output

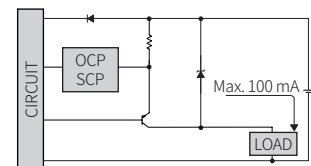

01) Through-beam type: max. 100mA, diffuse reflective or convergent reflective type: max. 50 mA

- OC (over current protection), SCP (short circuit protection)
- If short-circuit the control output terminal or supply current over the rated specification, normal control signal is not output due to the protection circuit.

Sensitivity Adjustment

- Set the adjuster for stable Light ON area, minimizing the effect of the installation environment.
- Use the offered adjustment screwdriver. Do NOT turn with excessive force to prevent product damage.
- The steps below are based on Light ON mode.

STEP	Status	Description
01	Received	Turn the adjuster from MIN to MAX sensitivity and check the position (A) where the operation indicator activates under the light ON area.
02	Interrupted	Turn the adjuster from (A) to MAX and check the position (B) where the operation indicator activates under the light OFF area. If the operation indicator does NOT activate at the MAX (maximum sensitivity): MAX = (B).
03	-	Set the adjuster at the mid position between (A) and (B) for optimal sensitivity.

Dimensions

- Unit: mm, For the detailed drawings, follow the Autonics website.

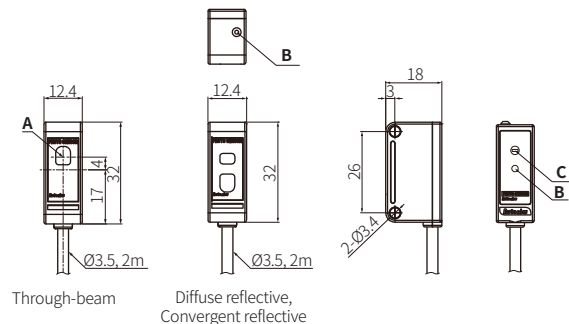

A	Optical axis
B	Upper operation indicator of convergent reflective type (red)
C	Sensitivity adjustment adjuster or timer adjuster of built-in timer model

Bracket A

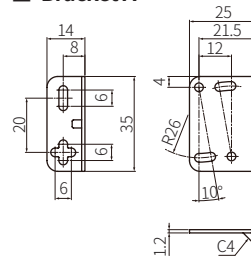

Specifications

Model	BYD3M-TDT-□	BYD100-DDT	BYD□-DDT-□
Sensing type	Through-beam	Diffuse reflective	Convergent reflective
Sensing distance	3 m	100 mm ⁰¹⁾	10 to 30 mm ±10% ⁰¹⁾ 10 to 50 mm ±10% ⁰¹⁾
Sensing target	Opaque materials	Opaque materials, translucent materials	Opaque materials, translucent materials
Min. sensing target	≥ Ø 6 mm	-	-
Hysteresis	-	≤ 25 % of sensing distance	≤ 10 % of sensing distance
Response time	≤ 1 ms	Operation: ≤ 3 ms Return: ≤ 100 ms	Operation: ≤ 3 ms Return: ≤ 100 ms ⁰²⁾
Light source	Infrared	Infrared	Infrared
Sensitivity adjustment	-	YES (Adjuster)	-
Timer function	-	-	OFF delay mode: 0.1 to 2 sec (Adjuster)
Operation mode	Dark ON mode	Light ON mode	Light ON mode
Indicator	Front	Front	Front / Upper operation indicator model
	Operation indicator (red)		
Approval	CE ENEC	CE ENEC	CE ENEC
Unit weight (packaged)	≈ 80 g (≈ 105 g)	≈ 38 g (≈ 75 g)	≈ 38 g (≈ 75 g)

01) Non-glossy white paper 50 × 50 mm

02) When the timer adjuster is set to min (0.1 sec).

Power supply	12-24 VDC± ±10% (ripple P-P: ≤ 10%)
Current consumption	It depends on the sensing type
Through-beam	Emitter: ≤ 30 mA, receiver: ≤ 30 mA
Reflective	≤ 35 mA
Control output	Through-beam type : NPN open collector output / PNP open collector output model Diffuse reflective, convergent reflective type : NPN open collector output
Load voltage	≤ 30VDC±
Load current	Through-beam type : ≤ 100 mA Diffuse reflective, convergent reflective type : ≤ 50 mA
Residual voltage	NPN: ≤ 1 VDC±, PNP: ≤ 2.5 VDC±
Protection circuit	Reverse power protection circuit, output short overcurrent protection circuit
Insulation resistance	≥ 20 MΩ (500 VDC± megger)
Noise immunity	±240 VDC± the square wave noise (pulse width: 1 μs) by the noise simulator
Dielectric strength	1,000 VAC~ 50/60 Hz for 1 min
Vibration	1.5 mm double amplitude at frequency of 10 to 55 Hz (for 1 min) in each X, Y, Z direction for 2 hours
Shock	500 m/s ² (≈ 50 G) in each X, Y, Z direction for 3 times
Ambient illuminance (receiver)	Sunlight: ≤ 11,000 lx, incandescent lamp: ≤ 3,000 lx
Ambient temperature	-20 to 65 °C, storage: -25 to 70 °C (no freezing or condensation)
Ambient humidity	35 to 85 %RH, storage: 35 to 85 %RH (no freezing or condensation)
Protection rating	Through-beam, convergent reflective type (front operation indicator model) : IP64 (IEC standard), Others: IP50 (IEC standard)
Connection	Cable type
Cable spec.	Ø 3.5 mm, 3-wire (Emitter: 2-wire), 2 m
Wire spec.	AWG24 (0.08 mm, 40-core), insulator outer diameter: Ø 1 mm
Material	Case: ABS, sensing part: Acrylic, bracket: SPCC, bolt: SCM, nut: SCM, sleeve: Brass, Ni-plate

Sold Separately: Bracket B

- Unit: mm, For the detailed drawings, follow the Autonics website.

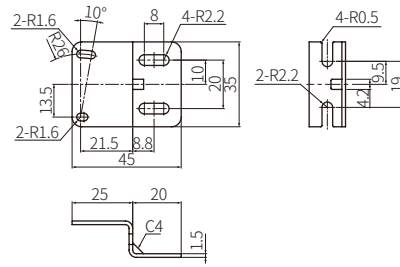

Sold Separately: Slit for Through-beam Type

■ BYD3M-ST (sticker)

- Unit: mm

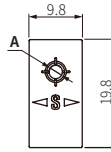

- Attach this slit at both an emitter and a receiver. (packaged unit: 2 pieces of each different Ø, total 8 pieces)
- Gently wipe the dirt on the lens of the sensor before using it.
- After attaching the slit, remove the front protection film.

A	Applied condition		Min. sensing target	Max. sensing distance
	Emitter	Receiver		
Ø 1.0 mm	○	○	≥ Ø 0.8 mm Opaque materials	500 mm
Ø 1.5 mm			≥ Ø 1.5 mm Opaque materials	700 mm
Ø 2.0 mm			≥ Ø 2.0 mm Opaque materials	1,200 mm
Ø 2.5 mm			≥ Ø 2.5 mm Opaque materials	2,300 mm

Feature Data: Through-beam Type

Sensing area

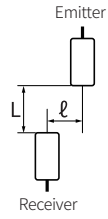

BYD3M-TDT

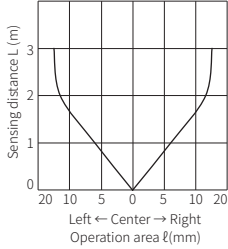

BYD3M-TDT + Slit

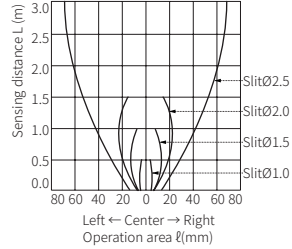

Emitter angle

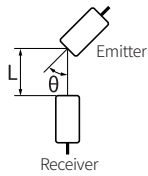

BYD3M-TDT

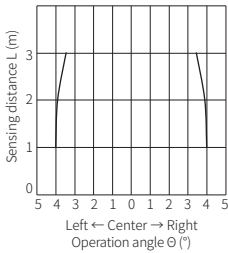

BYD3M-TDT + Slit

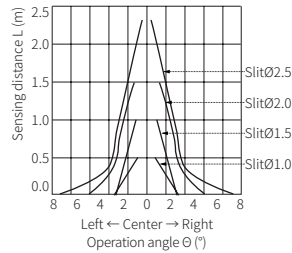

Feature Data: Diffuse Reflective Type

Sensing area

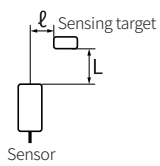

BYD100-DDT

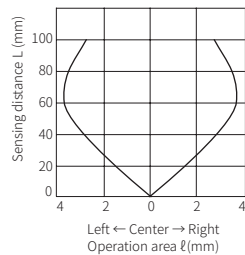

Feature Data: Convergent Reflective Type

Sensing area

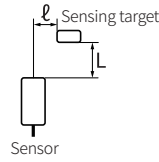

BYD30-DDT

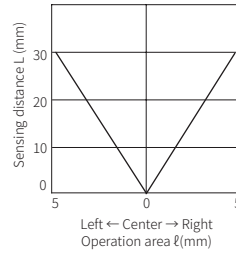

BYD50-DDT

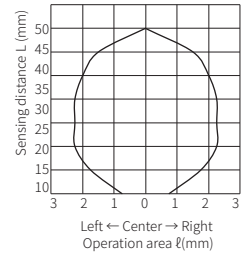

Sensing distance by color

The blind zone may exist about $\pm 10\%$ (3 mm / 5 mm) of the minimum/maximum sensing distance.

BYD30-DDT

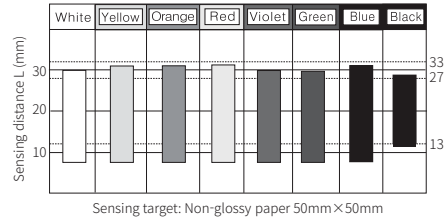

BYD50-DDT

