

30-Channel Counters

CM6M Series

INSTRUCTION MANUAL

TCD230041AB

Autonics

Thank you for choosing our Autonics product.

Read and understand the instruction manual and manual thoroughly before using the product.

For your safety, read and follow the below safety considerations before using.

For your safety, read and follow the considerations written in the instruction manual, other manuals and Autonics website.

Keep this instruction manual in a place where you can find easily.

The specifications, dimensions, etc. are subject to change without notice for product improvement. Some models may be discontinued without notice.

Follow Autonics website for the latest information.

Safety Considerations

- Observe all 'Safety Considerations' for safe and proper operation to avoid hazards.
- ⚠ symbol indicates caution due to special circumstances in which hazards may occur.

Warning Failure to follow instructions may result in serious injury or death.

- Fail-safe device must be installed when using the unit with machinery that may cause serious injury or substantial economic loss.** (e.g. nuclear power control, medical equipment, ships, vehicles, railways, aircraft, combustion apparatus, safety equipment, crime / disaster prevention devices, etc.)
Failure to follow this instruction may result in personal injury, economic loss or fire.

- Do not use the unit in the place where flammable / explosive / corrosive gas, humidity, direct sunlight, radiant heat, vibration, impact, or salinity may be present.**
Failure to follow this instruction may result in explosion or fire.

- Install on a device panel to use.**
Failure to follow this instruction may result in fire or electric shock.

- Do not connect, repair, or inspect the unit while connected to a power source.**
Failure to follow this instruction may result in fire.

- Check 'Connections' before wiring.**
Failure to follow this instruction may result in fire.

- Do not disassemble or modify the unit.**
Failure to follow this instruction may result in fire.

Caution Failure to follow instructions may result in injury or product damage.

- When connecting the power / sensor input and relay output, use AWG 20 (0.50 mm²) cable or over, and tighten the terminal screw with a tightening torque of 0.74 to 0.90 N m.**
Failure to follow this instruction may result in fire or malfunction due to contact failure.

- Use the unit within the rated specifications.**
Failure to follow this instruction may result in fire or product damage.

- Use a dry cloth to clean the unit, and do not use water or organic solvent.**
Failure to follow this instruction may result in fire or electric shock.

- Keep the product away from metal chip, dust, and wire residue which flow into the unit.**
Failure to follow this instruction may result in fire or product damage.

Cautions during Use

- Follow instructions in 'Cautions during Use'. Otherwise, it may cause unexpected accidents.
- Power supply should be insulated and limited voltage / current or Class 2, SELV power supply device.
- Use the product, 0.1 sec after supplying power.
- When supplying or turning off the power, use a switch or etc. to avoid chattering.
- Install a power switch or circuit breaker in the easily accessible place for supplying or disconnecting the power.
- Keep away from high voltage lines or power lines to prevent inductive noise. In case installing power line and input signal line closely, use line filter or varistor at power line and shielded wire at input signal line. Do not use near the equipment which generates strong magnetic force or high frequency noise.
- This unit may be used in the following environments.
 - Indoors (in the environment condition rated in 'Specifications')
 - Altitude max. 2,000 m
 - Pollution degree 2
 - Installation category I

Ordering Information

This is only for reference, the actual product does not support all combinations. For selecting the specified model, follow the Autonics website.

CM **1** **2** - **3** **4** **5**

- | | | |
|--|------------------------------------|-------------------------------------|
| 1 Display digits
6: 6-digit | 3 Channels
30: 30 | 5 Power supply
2: 24 VDC≐ |
| 2 Size
M: DIN W 72 × H 72 mm | 4 Input code
B: BCD code | |

Product Components

- Product (+ bracket)
- Instruction manual

Unit Descriptions

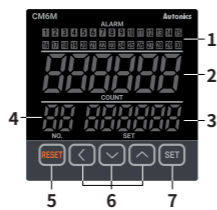

- Alarm output indicator (green)**
 - Turns ON when the counting value of the channel is arrived at the SV.
 - Turns OFF when the counting value of the channel is reset.
- Counting value display (red)**
 - RUN mode: displays counting value by channels.
 - No. of CHs setting mode: displays [SET-CH].
 - Resetting counting value by CH mode: flashes.
- Setting value display (green)**
 - RUN mode: displays the SV by the CH.
 - No. of CHs setting mode: displays the number of the channels.

- CH display (red)**
 - Displays the channel which value is displayed at the counting value display and the setting value display.
 - Resetting counting value by CH mode: flashes.

No.	Part name	Name plate	Function
5	RESET key	[RESET]	
6	Setting key	[◀], [▼], [▲]	Refer to 'Operation and Settings'
7	SET key	[SET]	

Dimensions

- Unit: mm, For the detailed drawings, follow the Autonics website.

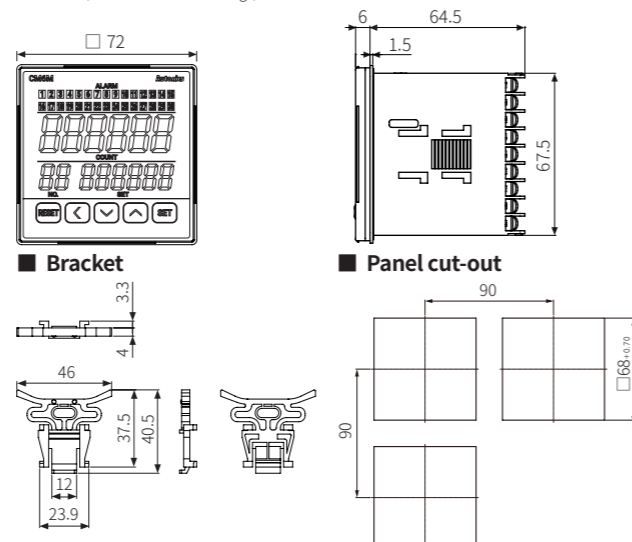

Bracket

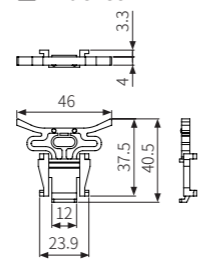

Panel cut-out

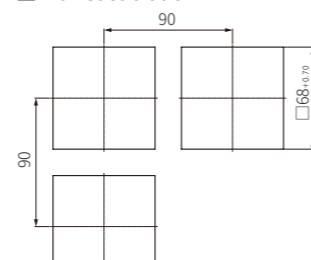

Connections

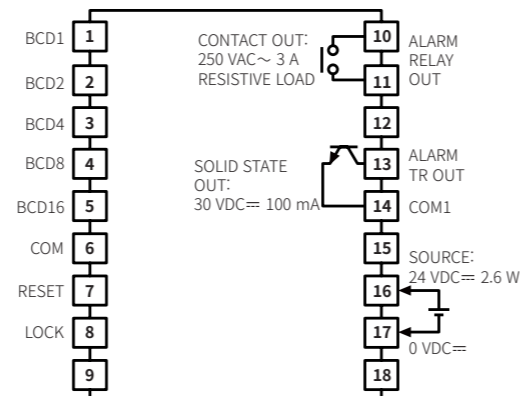

Operation and Settings

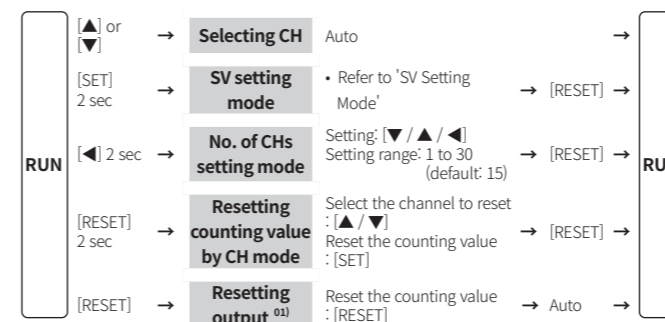

- Press the [RESET] key once to reset the counting value of the lowest channel which alarm output indicator turns ON in RUN mode. When more than one alarm output indicators turn ON, alarm output becomes ON. To turn off the alarm output, the all channels which alarm output became ON should be reset.

SV Setting Mode

- Hold the [SET] key over 2 sec to enter SV setting mode in RUN mode. The CH display flashes.
- In the CH display, press the [▲ / ▼] keys to set the channel you want to change.
- Press the [SET] key to save the set channel value.
- In the setting value display, press the input keys to change the SV from fifth digit.
 - [▲ / ▼] key = Change SV
 - [◀] key = Move to higher digit
 - [SET] key = Move to lower digit
 After setting the first digit, save the SV.
 - Setting range: 0 (default) to 999999
 - When the SV is 0 at SV setting mode, that channel does not count even if the counting value signal is inputted.
- Repeat the 2 to 4 orders for SV of each channel.
- Press the [RESET] key in the flashing state of the CH display to return RUN mode.

Example of Output Operation

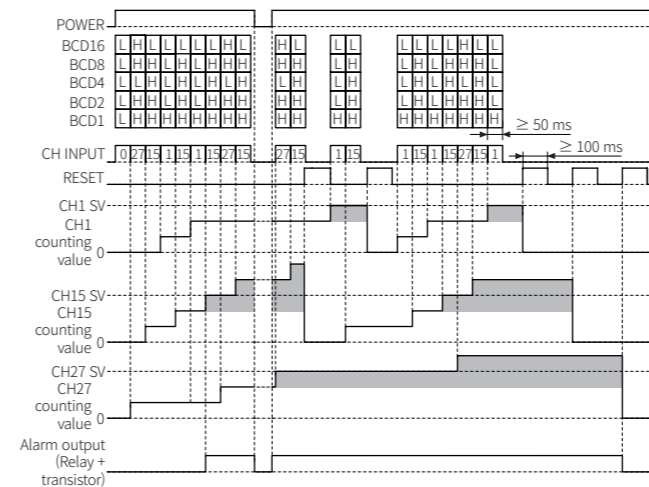

- When the counting value of the channel is arrived at the SV, the alarm output indicator of the channel turns ON. The shaded parts mean flashing the counting value display. Even though the counting value is arrived at the SV, the counting value increases continuously.
- Press the [RESET] key to reset the counting value and alarm output indicator of the lowest channel (e.g.: the order of CH 1 → CH 15 → CH 27) which counting value is arrived at SV.

Input Operation Mode

Counting value signal input

- Set the number of channels at No. of CHs setting mode. In case of not setting channel, that channel does not count even if the counting value signal is inputted.

Terminal No.	Terminal input	Channels	Counting
5	BCD16	16	Counting value of the channel increases as 1 which number is combination of terminal input number.
4	BCD8	8	
3	BCD4	4	
2	BCD2	2	
1	BCD1	1	

BCD16	BCD8	BCD4	BCD2	BCD1	Channel	Operation
L	H	L	L	H	9	Counting value of the channel increases as 1
L	L	H	H	L	6	
H	H	L	L	H	25	
H	L	L	L	H	17	

Reset signal input

The function of the [RESET] key and no. 7 terminal is the same. Refer to 'Operation and Settings'.

Key lock signal input

All front keys are not available while the signal is inputted at no. 8 terminal.

Input connections

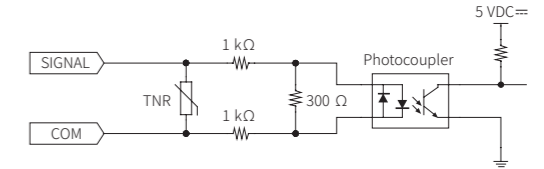

Specifications

Model	CM6M-30B2
Display digits	Counting / Setting value display: 6-digit CH display: 2-digit
Display method	7-segment LED method - Counting value / CH display: red - Alarm output indicator / Setting value display: green
Alarm output indicator (W×H)	2.7 × 3.3 mm
Character size (W × H)	Setting value display: 5.5 × 11 mm Counting value display: 8 × 16 mm
Number of channels	Max. 30CH
Max. counting speed	20 cps
Counting range	0 to 999999
Min. signal width	RESET signal: ≥ 100 ms Counting value signal: ≥ 50 ms
Input method	BCD code (positive logic)
Input level	[H]: 16 - 30 VDC≐, [L]: 0 - 3 VDC≐
Alarm output	Contact Soild state
Type	SPST (1a) × 1 NPN open collector output × 1
Capacity	250 VAC~ 3 A resistive load ≤ 30 VDC≐ 100 mA
Certification	CE
Unit weight (packaged)	≈ 145 g (≈ 215 g)

Power supply	24 VDC≐
Permissible voltage range	90 to 110 % of rated voltage
Power consumption	2.6 W
Memory retention	≈ 10 years (non-volatile semiconductor memory type)
Insulation resistance	≥ 100 MΩ (500 VDC≐ megger)
Dielectric strength	Between the charging part and the case : 2,000 VAC~ 50 / 60 Hz for 1 minute
Noise immunity	± 500 V square wave noise (pulse width: 1 μs) by the noise simulator
Vibration	0.75 mm double amplitude at frequency of 10 to 55 Hz in each X, Y, Z direction for 1 hour
Vibration (malfunction)	0.5 mm double amplitude at frequency of 10 to 55 Hz in each X, Y, Z direction for 10 min
Shock	300 m/s ² (≈ 30 G) in each X, Y, Z direction for 3 times
Shock (malfunction)	100 m/s ² (≈ 10 G) in each X, Y, Z direction for 3 times
Relay life cycle	Mechanical: ≥ 10,000,000 operations Electrical: ≥ 100,000 operations
Ambient temperature	-15 to 55 °C, storage: -25 to 65 °C (no freezing or condensation)
Ambient humidity	35 to 85 %RH, storage: 35 to 85 %RH (no freezing or condensation)
Protection structure	IP54 (front part, IEC standard)