

# ROTARY ENCODER GUIDE

---

Thank you for purchasing Autonics product.

Before use, be sure to read the safety considerations and use them correctly.

**Autonics**

# CONTENTS

<b>Selecting Rotary Encoders</b>	3
<b>What is a Rotary Encoder?</b>	4
<b>Operating Principles</b>	4
<b>Output Types and Connection Example</b>	5
<b>Glossary</b>	7
<b>Misalignment</b>	8
<b>Proper Usage</b>	8
<b>APPENDIX</b>	

## Selecting Rotary Encoders

It is an element to select a rotary encoder. Select the right product for each element for the most optimal detection. You can check the details by referring to the contents.

**1 Encoder type** Rotary encoder type is selected according to the intended use.

**Incremental rotary encoder, absolute rotary encoder**

**2 Principle of operation** Select the principle of operation of the Rotary encoder

**Optical, magnetic**

**3 Rotation method** Select the rotation method of the Rotary encoder (absolute rotary encoder only)

**Single-turn, multi-turn**

**4 Size** Select the size of the Rotary encoder

**Ultra-small, small, middle**

**5 Shaft appearance** Select the shaft appearance of the Rotary encoder

**Shaft type, hollow shaft type, built-in hollow shaft type etc.**

**6 Output code** Select the output code of the Rotary encoder

**Binary code, BCD code, Gray code**

**7 Power type** Select the power type of the Rotary encoder

**5 VDC=, 12 VDC=, 12-24 VDC=, 15 VDC=**

**8 Control output** Select the control output of the Rotary encoder

**Totem pole output, NPN open collector output, PNP open collector output, Line driver output etc.**

**9 Connection method** Select the connection method of the Rotary encoder

**Cable type, connector type, cable connector type**

# What is a Rotary Encoder?

Rotary encoder is a device that converts shaft's rotation angle into electrical signals (pulse) and provides an output. In case of incremental type, rotation direction is detected by A, B phase output timing. In case of absolute type, rotation direction is detected by increment / decrement of output code. The absolute type does not need zero point return due to the code for rotation angle output.

## Operating Principles

### Optical rotary encoder

#### 01. Incremental rotary encoder

Incremental rotary encoder consists of a rotating slit which is painted black pattern and a fixed slit between light emitting elements and light receiving elements. By rotating encoder's shaft, light from the light emitting elements passes through these slits, or is blocked. The passing light is converted as current signal by light receiving element. This current signal outputs square wave pulse through a wave shaping circuit and an output circuit. Incremental output phases are A phase, B phase which have phase difference at 90°, and Z phase, zero-reference phase.

#### Functional block diagram

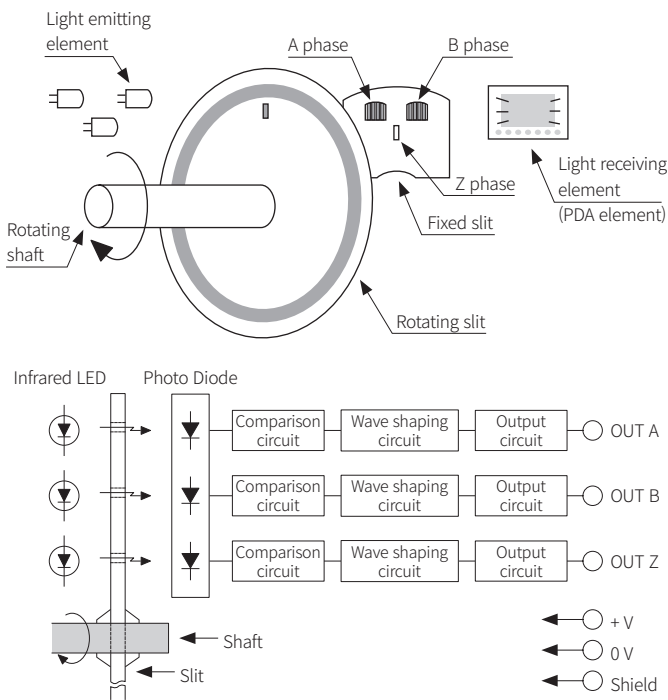

#### 02. Absolute rotary encoder

The absolute rotary encoder divides from 0° to 360° as certain rate and specifies electrical digital code (BCD, Binary, Gray code) to the each divided angle position. The absolute rotary encoder as the absolute angle sensor outputs the specified digital code according to the rotational shaft position. Due to no impact on the electric characteristics, this encoder does not need memory retention circuit against power failure and has high noise immunity.

#### Functional block diagram

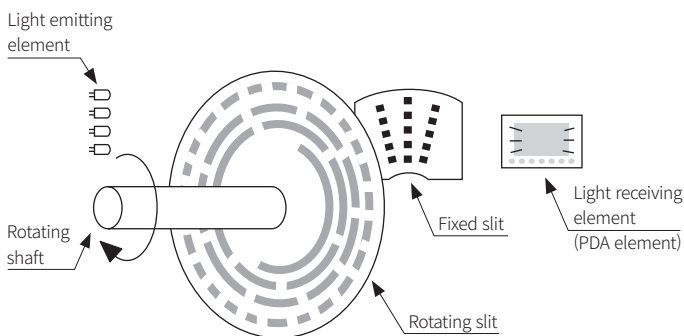

### Magnetic rotary encoder

Magnetic rotary encoder is operated by processing signal of magnetic field change from rotated magnet. (Autonics magnetic rotary encoder is absolute type.) The absolute rotary encoder divides from 0° to 360° as certain rate and specifies electrical digital code (BCD, Binary, Gray code) to the each divided angle position. The absolute rotary encoder as the absolute angle sensor outputs the specified digital code according to the rotational shaft position. Magnetic rotary encoder does not have slit. This is strong vibration and shock and the life expectancy is longer than optical type.

#### Functional block diagram

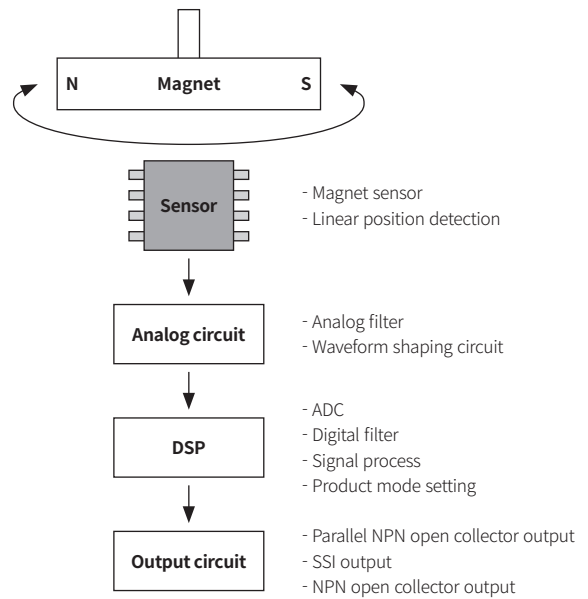

### Characteristics by Operation Principle

	Optical	Magnetic
<b>Vibration, Shock</b>	Weak	Stronger than optical type (∵ no slit)
<b>Life expectation</b>	Short	Longer than optical type
<b>Accuracy</b>	High	Lower than optical type

## Output Types and Connection Example

### ■ Totem pole output

A totem pole output is a type of electronic circuit that consist of two transistors between +V and 0 V as shown in the figure below.

When output signal is "H", upper transistor will be ON and lower transistor will be OFF. When output signal is "L", upper transistor will be OFF and lower transistor will be ON.

Totem pole output features low output impedance because the circuit is designed to be capable of flowing current in both directions. In addition, it has little influence of waveform distortion and noise, and is used for longer encoder line.

#### • Output circuit

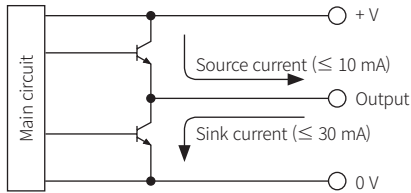

#### • Equivalent circuit

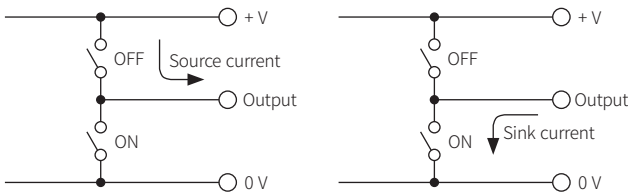

#### • Load connection example

- In case of voltage output type

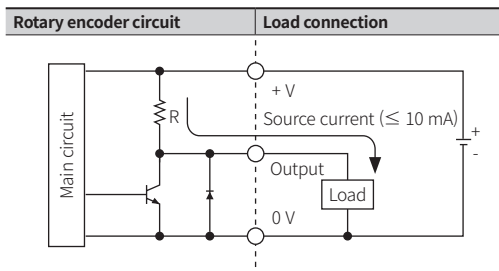

- In case of NPN open collector output type

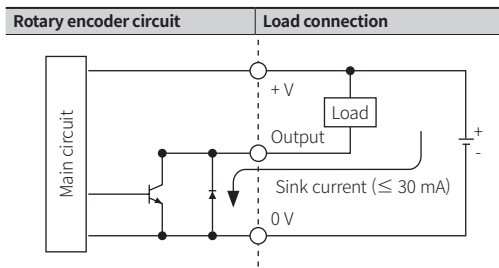

#### • Connection example totem pole output type and IC circuit

If certain deviation occurs between encoder's max. output signal voltage ( $V_{out}$ ) and max. allowable input voltage of logic IC ( $V_{in}$ ), it is required to adjust circuit's voltage level as shown in the figure below.

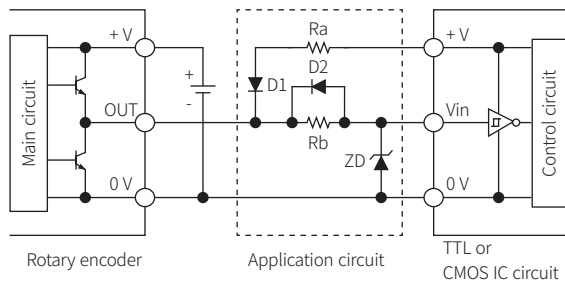

#### • If input voltage of control circuit is lower than applied voltage of encoder

- Make sure that zener voltage on ZD should be the same with max. allowable input voltage ( $V_{in}$ ) of logic IC circuit.
- Make sure that Ra and Rb should be adjusted to stable input signal level when designing application circuit.
- In case cable length between encoders and control circuit is short, it is fine to design the circuit without Ra and D1.

#### • Connection example totem pole output type and photo coupler

Encoder's output circuit can be isolated by using photo coupler as shown in the figure below.

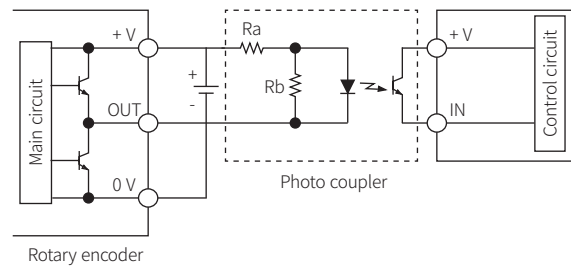

#### • All components applied to application circuits shall be connected adjacent to photo coupler.

- Make sure to select the photo coupler having higher response speed than encoder's max. response frequency.

### ■ NPN open collector output

As shown below, it is one of various output types using NPN transistor to connect emitter with 0 V terminal, and to open +V terminal with collector so that collector terminal can be used as an output terminal.

It is useful when encoder's power voltage and controller's power voltage are not matched.

#### • Output circuit

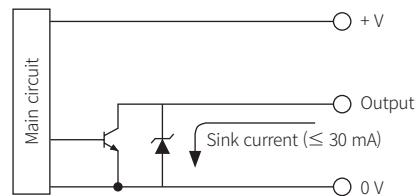

#### • Equivalent circuit

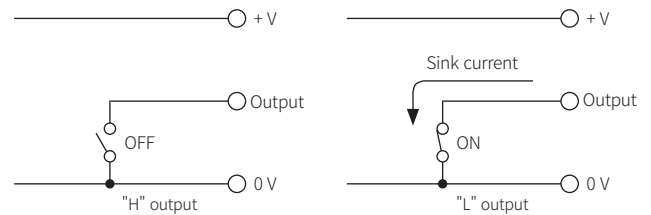

#### • Connection example of NPN open collector output type collector and counter

When connect to a counter which is voltage input type, please connect to pull-up resistance between +V and output (transistor's collector) from external

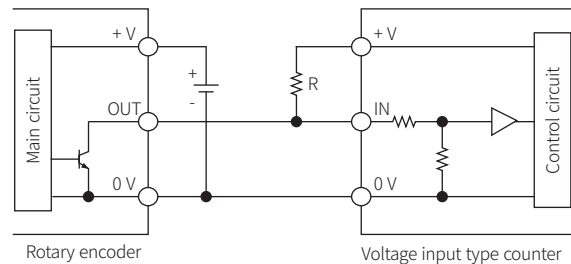

- Make the value of pull up resistance under 1/5 of input impedance of a counter.

#### • Connection example of NPN open collector output type and photo coupler

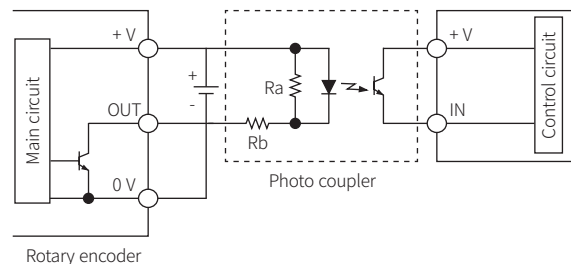

- Ra value should be a high resistance within the stable operating range of photo coupler.

- Rb value should be within the stable operating range of photo coupler. This value is not exceeded the rated load current of rotary encoder.

## Output Types and Connection Example

### PNP open collector output

As shown below, it is one of various output types using PNP transistor to connect emitter with "+V" terminal, and to open "0V" terminal with collector so that collector terminal can be used as an output terminal. (absolute rotary encoder only.)

#### Output circuit

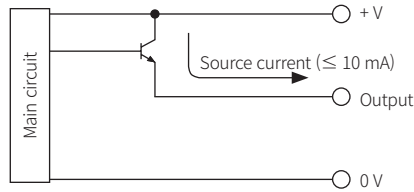

#### Equivalent circuit

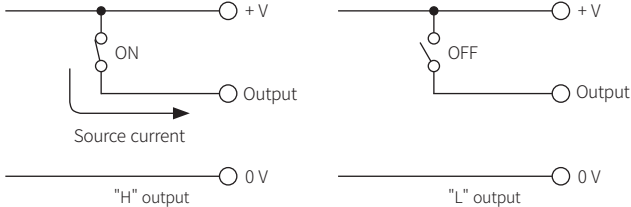

#### Connection example of PNP open collector output type and external application circuit

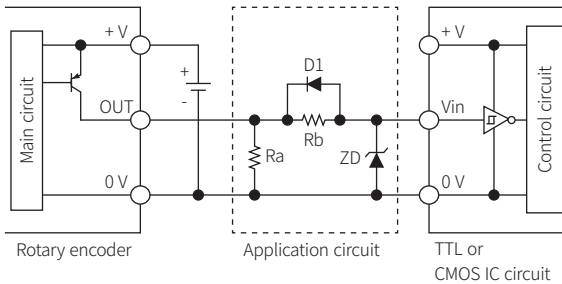

- Use low resistance for Ra and Rb values within the range that does not exceed the rated load current of the rotary encoder.
- Select components that make zener voltage of ZD the same as maximum allowable input voltage of logic IC.

#### Connection example of PNP open collector output type and photo coupler

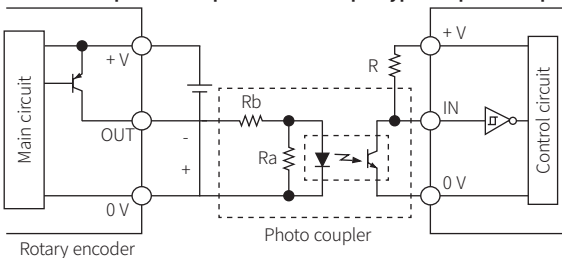

- Use low resistance for Ra and Rb values within the range that does not exceed the rated load current of the rotary encoder.

### Line driver output

Line Drive output uses Line Drive exclusive IC on output circuit as shown below. That exclusive IC has high speed response. So, it is proper for long-distance transmission and is strong on noise.

However, use IC corresponded to RS422A on response side.

Also, in case of extending wiring length, use twisted pair line. If make output line, it is able to get a characteristic to eliminate normal mode noises as offsetting electromotive force occurred in line.

(Terminating resistance of receiver ( $Z_0$ ):  $\approx 200\Omega$ )

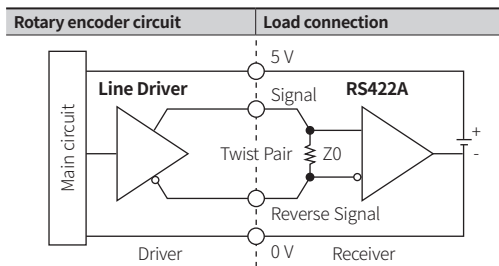

### Connection example of rotary encoder and PLC

Rotary encoder output is able to connect PLC which is DC type input module. Be sure to set the output pulse of rotary encoder longer enough (more than 10 times) than scan time of PLC. (Either make rpm lower or use a low pulse encoder.) Because DC power of PLC is not stabilized, please supply stable power to rotary encoder.

#### Common terminal is "0V"

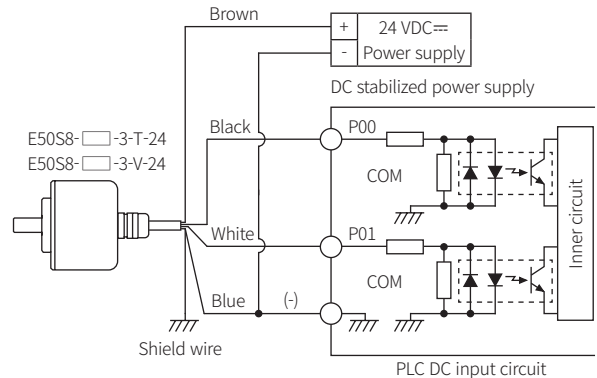

#### Common terminal is "+24V"

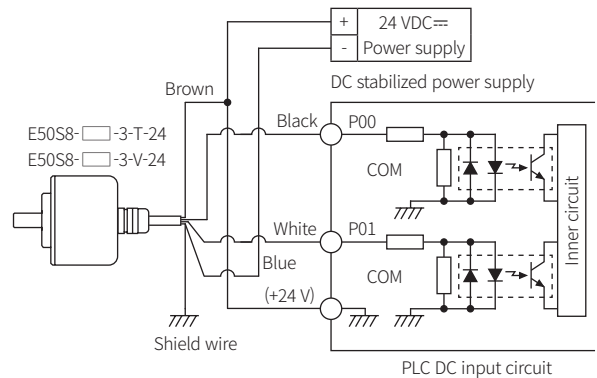

## Glossary

### Resolution

Resolution is number of output pulse while rotary encoder shaft revolves once. For incremental rotary encoder, resolution means number of graduations on a silt, and for absolute rotary encoder, resolution means number of divisions.

### Starting torque

The torque needed to rotate the shaft of the rotary encoder at startup. The torque during rotation is normally lower than the starting torque.

### Max. response frequency

The max. number of pulses that rotary encoder could respond electronically in a sec. And it also can be the shaft speed when the device in which the encoder is used is in operation.

$$\text{Max. response frequency} = \frac{\text{Max. revolutions}}{60} \times \text{Resolution}$$

• Max. revolutions should be within max. allowable revolutions. Resolution should not be exceeded max. response frequency.

### Max. allowable revolution (rpm) - Mechanical specification

It means the mechanical maximum allowable revolution of rotary encoder, and has an impact on the lifetime of the encoder.

So, please do not exceed the rated values listed in.

### Max. response revolution (rpm)- Electronic specification

The maximum revolution speed for rotary encoder to output electric signal ordinarily. It is decided by max. response frequency and resolution.

$$\text{Max. response revolution} = \frac{\text{Max. response frequency}}{60} \times \text{Resolution}$$

Set resolution that makes max. response revolution not to exceed max. allowable revolution.

### CW (Clock Wise)

The clockwise direction of rotation from the shaft, the shaft. (A phase precedes B phase at 90° in our company's standard feature.)

### CCW (Counter Clock Wise)

The counterclockwise direction of rotation from encoder's shaft. (B phase precedes A phase at 90° in our company's standard feature.)

### A, B Phase

Digital signals of which phase difference is 90°, and that is to determine the direction of rotation.

### Z Phase

Signal that is generated once a revolution and is called zero-reference phase.

### Binary code

The most basic code expressed in combination of 0 and 1. E.g.) In case of converting decimal digit 27 to binary code

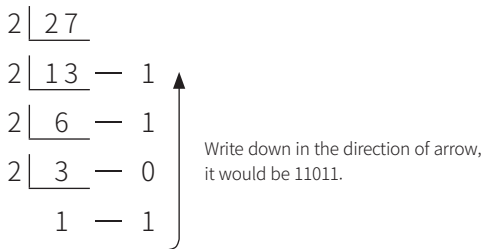

### BCD code (Binary-Coded Decimal code)

It is a binary-coded decimal system. Because it is easy to change a decimal code to binary code with the '8 4 2 1' that indicates the weight of each bit, it is widely used with controllers and counters. E.g.) In case of converting decimal digit 23 to binary-coded decimal code

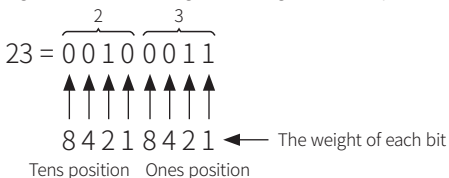

### Gray code

Gray code is made to complement the defects of binary code. Only one bit changes state form one position to another so that it prevents errors occurring. E.g.) In case of converting decimal digit 12 (1100 in binary code) to gray code

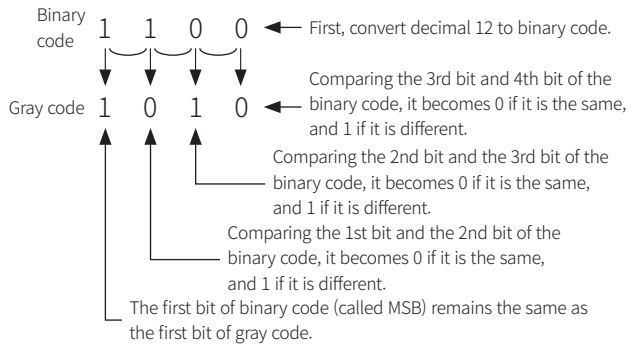

### Absolute code table

Decimal	Gray code				Binary code				BCD code						
	2 <sup>4</sup>	2 <sup>3</sup>	2 <sup>2</sup>	2 <sup>1</sup>	2 <sup>0</sup>	2 <sup>4</sup>	2 <sup>3</sup>	2 <sup>2</sup>	2 <sup>1</sup>	2 <sup>0</sup>	×10		×1		
0	0	0	0	0	0	0	0	0	0	0	0	0	0	0	0
1	0	0	0	0	1	0	0	0	0	1	0	0	0	0	0
2	0	0	0	1	1	0	0	0	1	0	0	0	0	0	1
3	0	0	0	1	0	0	0	0	1	1	0	0	0	0	1
4	0	0	1	1	0	0	0	1	0	0	0	0	0	0	1
5	0	0	1	1	1	0	0	1	0	1	0	0	0	0	1
6	0	0	1	0	1	0	0	1	1	0	0	0	0	0	1
7	0	0	1	0	0	0	0	1	1	1	0	0	0	0	1
8	0	1	1	0	0	0	1	0	0	0	0	0	0	1	0
9	0	1	1	0	1	0	1	0	0	1	0	0	0	1	0
10	0	1	1	1	1	0	1	0	1	0	0	0	0	1	0
11	0	1	1	1	0	0	1	0	1	1	0	0	0	1	1
12	0	1	0	1	0	0	1	1	0	0	0	0	0	1	1
13	0	1	0	1	1	0	1	1	0	1	0	0	0	1	1
14	0	1	0	0	1	0	1	1	1	0	0	0	0	1	1
15	0	1	0	0	0	0	1	1	1	1	0	0	0	1	1
16	1	1	0	0	0	1	0	0	0	0	0	0	0	1	0
17	1	1	0	0	1	1	0	0	0	1	0	0	0	1	0
18	1	1	0	1	1	1	0	0	1	0	0	0	1	0	0
19	1	1	0	1	0	1	0	0	1	1	0	0	0	1	1
20	1	1	1	1	0	1	0	1	0	0	0	0	0	1	0
21	1	1	1	1	1	1	0	1	0	1	0	0	1	0	1
22	1	1	1	0	1	1	0	1	1	0	0	0	1	0	1
23	1	1	1	0	0	1	0	1	1	1	0	0	1	0	1
24	1	0	1	0	0	1	1	0	0	0	0	0	1	0	0
25	1	0	1	0	1	1	1	0	0	1	0	0	1	0	0

## Misalignment

### Parallel misalignment

It rotates with parallel misalignment by  $\delta$  when the centers of two axes connected by a coupling are not symmetrical.

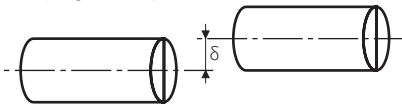

### Angular misalignment (symmetrical)

It rotates with angular misalignment by  $\alpha$  when the center distances of two axes connected by a coupling are equal.

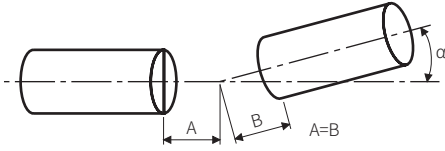

### Angular misalignment (non-symmetrical)

It rotates with angular misalignment by  $\alpha$  when the center distances of two axes connected by a coupling are not equal.

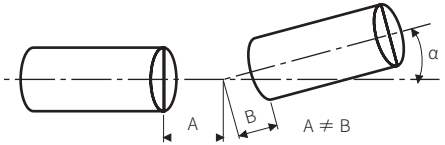

### Combined parallel and angular misalignment

It rotates with parallel misalignment by  $\delta$  and angular misalignment by  $\alpha$  when the centers of two axes connected by a coupling are not paralleled.

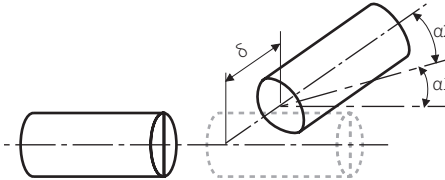

### End-Play

It rotates with End-play by X from one of two shafts connected by a coupling.

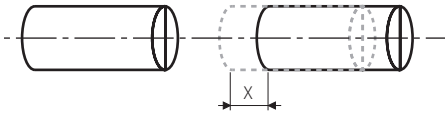

### Run out

It rotates with vibration in a radial direction.

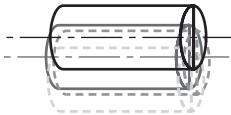

## Proper Usage

### Caution for installation and using

Because rotary encoder consist of precision parts, excessive force can cause internal slit damaged. So, please be careful when using it.

- When combine to chains, timing belts, toothed wheels, use the coupling so that the axis of encoder is not impacted by an excessive force.

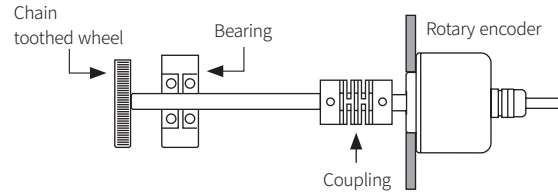

- Do not apply excessive loads to the axis of rotation.

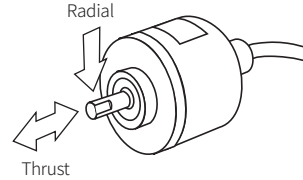

- Be sure not to inflict more than 30 N of the tensile on Rotary encoder wiring.

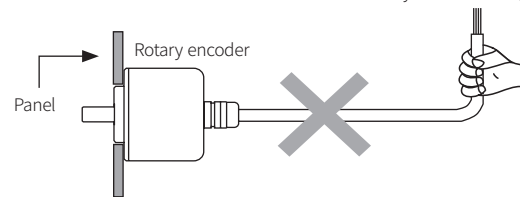

- Do not drop water or oil on the rotary encoder. Otherwise, it may cause malfunction.
- Do not hammer when combining either hollow shaft or built-in type encoder with a body of revolution. Especially be careful with high-pulse encoder that has fragile glass slit.
- Pulse phase of encoder varies depending on the direction of rotation. If the shaft rotates right when see it from the end of the shaft, it is Clockwise (CW). And if it rotates left, it is Counterclockwise (CCW).
- A phase precedes B phase at 90° when it is on CW.

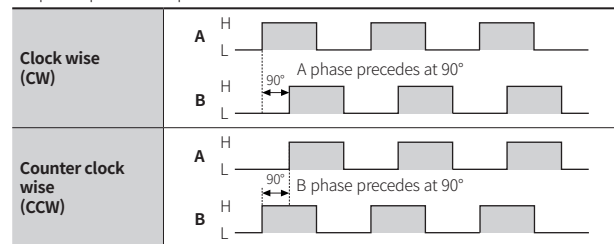

### Cautions when connecting wiring

Cable shield line of rotary encoder is directly connected to the case, so please ground the metal parts of encoder case to prevent malfunction from being caused by external noises. Also make sure shield line of encoder cable to be grounded, not to be opened.

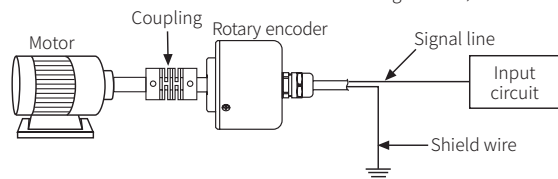

- Work on the wiring when power is turned off. And wrap it with pipe separately from other wires like power line, otherwise malfunction or internal circuit failure can be caused.
- It is better to shorten the wire length otherwise, the fall and rise time of wave form gets as long as the wire extended. Because which make it impossible to get an wanted output wave, please use it after standardizing the wave form using Schmidt trigger circuit.

### Vibration

- If vibration is inflicted to rotary encoder, pulses can be caused in wrong way. Thus, please place it in vibration-less area.
- The more pulses in one revolution, the narrower the gradations on resolution curve, and in which condition, operation vibration can be transmitted and that may cause uncommon pulses.





# APPENDIX

<b>Safety Certification for Product and Component</b>	III
<b>Communication Standards</b>	V
<b>IP Code (protection against dust and water)</b>	VI

## Safety Certification for Product and Component

- For detailed certification information, visit the website of each certification body.
- For the status of certification on our product, visit the Autonics website.

### ■ CE

- Country: European Union



CE marking is the conformity marking, meaning that it complies with all Directives of the Council of European Union regarding safety, health, environmental, and consumer protection standards.

If a product judged to be a risk to the consumer's health, safety, and environmental protection, is sold in the European market, the CE mark must be affixed. It is an essential certification for entry into the European market.

### ■ UL Listed

- Country: United States



UL listing is the American standard for safety. It is a non-mandatory standard, but most States mandate this standard. This certification is highly favored by consumers.

UL Listed Mark means the end product meets standards of safety.

### ■ TR CU

- Country: Eurasian Economic Union



The EAC certification is accredited by five member countries of the Eurasian Economic Union (EAEU): Russia, Kazakhstan, Belarus, Armenia, and Kyrgyzstan.

Regulated products without the EAC mark are prohibited to access the markets of 5 members of EAEU.

- Type of certification  
: Certificate of Conformity (CoC),  
Declaration of Conformity (DoC)

### ■ KC

- Country: Republic of Korea



The KC certification mark must be affixed on an imported or domestically manufactured electrical product that is to be distributed or sold in Korea.

Type of certification: safety certification, EMC certification

- Safety certification: Korean Agency for Technology and Standards (KATS) affixes and manages the KC certification mark for electrical appliances, household goods, and children's products by dividing the steps into safety certification / safety confirmation / supplier's declaration of conformity (SODC) according to the different levels of potential danger.
- EMC certification: Manufacture, sale, or import for equipment that may cause harm to the radio environment and broadcasting communication network, or that may cause or receive significant electromagnetic interference, the KC certification mark is issued through electromagnetic compatibility (EMC) testing.

### ■ S-Mark

- Country: Republic of Korea



The S-Mark is the optional certification system to prevent industrial accidents. Korea Occupational Safety and Health Agency (KOSHA) conducts a comprehensive evaluation for the safety and reliability of product, and the capability of quality control in manufacturing.

Due to non-mandatory, there is no regulation or disadvantage on the uncertified product.

### ■ UL Recognized

- Country: United States



UL listing is the American standard for safety. It is a non-mandatory standard, but most States mandate this standard. This certification is highly favored by consumers.

UL Recognized Mark means the components intended for use in a complete product or system meet standards of safety.

### ■ KCs

- Country: Republic of Korea



The Minister of Employment and Labor evaluates the safety of hazardous or dangerous machinery, equipment, facilities, protective devices, and protective equipment based on the 'safety certification standards.' Occupational Safety and Health Agency (Ulsan, in South Korea) certifies safety through comprehensive tests complying with the 'safety certification standards.'

Any person who intends to manufacture, import, or change major structural parts of products subject to safety certification, must obtain this certification.

## ■ TUV NORD

- Country: Germany



TUV is a leading German private certification body that has been responsible for many testing and certification tasks related to safety in the industry for a long time. It is intended to protect people and property from fire and other accidents. Currently, TUV is conducting tests and inspections on safety and quality in various industries such as machinery, electronics and electricity, automobiles, chemical facilities, nuclear power, and aircraft. It is voluntary standards, and certification is issued complying with various EU Directives and German safety regulations.

## ■ Metrology Certification

- Country: Russia



Metrology Certification is a certificate for measuring and test equipment. Registration of measuring equipment is currently being revised and implemented following the Russian Federal Law, and is managed and supervised by the measurement authority, which is the subject of the certification. Measurement authorities review and test measuring equipment to be used in the Russian Federation based on the State System of Measurement (SSM), issue certificates, and manage them in the government's online database for users and buyers to browse.

## ■ CCC

- Country: China



The China Compulsory Certificate system (CCC) is a compulsory mark for products that met Chinese technical standards and are allowed to be imported by the Chinese government. Foreign-imported industrial products are examined through CCC certification process whether they meet safety standards or not. The certified products are distributed and sold with the CCC mark or factory code according to the product. CCC certification is administered by the China Quality Certification Center (CQC).

## ■ PSE

- Country: Japan



PSE is a compulsory certification administered by the Ministry of Economy, Trade and Industry (METI) and governs by the Electrical Appliances Safety Law in Japan. The purpose is to minimize the occurrence of harm and damage caused by electrical equipment by regulating the manufacture and sale of electrical appliances and bring an engagement of the private sector to ensure the safety of electrical appliances. Manufacture, import, and sell electrical appliances in the Japanese market, the technical standards for those products must be satisfied and the PSE certification mark must be displayed.

## ■ GOST

- Country: Russia



GOST is national technical standards set by the Euro Asian Council for Standardization, Metrology and Certification (EASC). The abbreviation GOST stands for GOSudarstvennyy STandart, which means State Union Standard in Russian. The current GOST standard includes over 20,000 titles and is widely used in common in the Commonwealth of Independent States (CIS) (12 countries). All countries of the CIS currently adopt and use the GOST standard, but the certificates issued by each country and the subject of the issuing certification body are different, so each country's GOST certificate can be regarded as a different certificate. The national standards of Russia are the GOST R, those of Kazakhstan are GOST K, etc.

## ■ China RoHS

- Country: China



China RoHS is the Chinese government regulation to control and eliminate the environmental impact of toxic and hazardous substances and elements in electrical/ electronic equipment. China's Measures for the Administration of the Control of Pollution by Electronic Information Products like the EU RoHS Directive have been enacted, and regulate additional hazardous substances compare to EU RoHS. Marking a logo or label for marking information is mandatory. In addition, there is a certification system before selling the product to ensure its conformity by conducting test analysis. Products to be exported to China will be screened prior to customs entry. Customs entry is only permitted for products that meet conformance standards.

## Communication Standards

• For detailed information on communication, visit the related association's website.

### ■ EtherNet/IP

## EtherNet/IP™

EtherNet/IP is an industrial network protocol that conforms Common Industrial Protocol to standard Internet. It is one of the leading industrial protocols in the United States and is widely used in a variety of industries, including factories.

EtherNet/IP and CIP technologies are managed by ODVA, Inc., a global trade and standards development organization founded in 1995 with over 300 corporate members.

EtherNet/IP uses the most widely adopted Ethernet standards - Internet Protocol and IEEE 802.3 - to define functions for the transport, network, data link, and physical layer. CIP uses object-oriented design to provide EtherNet/IP with services and device profiles needed for real-time control and to promote consistent implementation of automation functions across a diverse ecosystem of products.

### ■ DeviceNet

## DeviceNet

DeviceNet is a digital multidrop network to interconnect industrial controllers and I/O devices. DeviceNet provides users a cost-effective network for distribution at no cost, deploys and manages simple devices across the architecture.

DeviceNet uses CAN (Controller Area Network), a network technology used in automobile vehicles, for its data link layer, and this network is used in almost all industries. DeviceNet is approved by CENELEC for its official standard and is also used as a global standard.

### ■ ProfiNet



PROFINET, designated and announced by PI (PROFIBUS & PROFINET), is the open standard for industrial Ethernet in automation technology. It provides solutions for process automation, factory automation and motion control. It enables the integration of existing fieldbus systems such as PROFIBUS, Interbus and DeviceNet into an open Ethernet-based network. PROFINET, the protocol for communication, configuration and diagnosis in the network, uses Ethernet standard as well as TCP, UDP, IP. It achieves fast and safe data exchange, enabling the concepts of innovative machine and plant. Thanks to its flexibility and openness, PROFINET offers the users a freedom in building machine and plant architectures and significantly increases plant availability by optimal use of resources available to users.

### ■ CC-Link



CC-Link is the open field network and the global standard with SEMI certification. As high-speed field network, CC-Link can process both control data and information data at the same time. With a high communication speed of 10 Mbps, it supports a transmission distance of 100 meters and connects to 64 stations.

It achieved high-speed response of up to 10 Mbps, guaranteeing punctuality. With CC-Link, complex production lines can be simplified and built at low cost. There are advantages of reducing the cost of wiring components, shortening the wiring construction period, and improving maintainability.

CLPA provides a memory map profile that allocates data for each product type. CC-Link compatible products can be developed based on this profile, and users can use the same program for connection and control even if existing product is replaced to other vendors' one.

### ■ EtherCAT

## EtherCAT®

EtherCAT (Ethernet for Control Automation Technology) is an Ethernet-based fieldbus system developed by Beckhoff Automation. After releasing the technology from ETG (EtherCAT Technology Group) in 2003, it is standardized in IEC 61158 since 2007. It is a communication method that uses the frame according to IEEE 802.3 and physical layer and is an Ethernet protocol-based automation software that requires low jitter, short cycle time, and reduced hardware cost.

EtherCAT supports almost all topologies which have the advantage of flexibility and user-friendly. Due to the high-speed network, EtherCAT is suitable for applications requiring simultaneous operation.

### ■ HART



HART is the global standard for digital information communication via analog wires between smart devices and control or monitoring systems.

It is the duplex communication protocol and supports various analog I/O modules with HART connection. It sends and receives digital information through 4-20 mA current. It provides a reliable and long-term solution for plant operators who seek the benefits of smart devices with digital communication while maintaining existing facilities for analog instrumentation and plant wiring. Many sites that have applied the HART protocol can access to many digital process, maintenance and diagnostic information.

### ■ ProfiBus



ProfiBus is the open standard commonly used for process automation in the production site.

- Configuration
    - Master: It determines data traffic, transmits messages, and performs as role of Active Station.
    - Slave: It means I/O devices, valves, motor drivers, transmitters, etc. Slave receives a message and transmits the message depending on the Master's request.
- Up to 124 slaves and 3 masters can be connected to one communication line, and the communication method uses the half duplex method. Each device is connected to the bus in parallel and each device has its network address, so the installation location is irrelevant. Each device can be moved or removed during the communication.







## IP Code (protection against dust and water)

### IEC (International Electro-technical Commission) Standard



The IP Codes are defined in the IEC standard 60529.



#### 1 Degree of protection against dust (protected from solid foreign objects)

Numeral	Degree of protection	Degree of protection
0	Non-protected	
1		Protection against the objects with 50 mm diameter or more. The object probe, sphere of 50 mm diameter, must not fully penetrate. - Test means : Rigid sphere without handle or guard. - Test force: 50 N ± 10%
2		Protection against the objects with 12.5 mm diameter or more. The object probe, sphere of 12.5 mm diameter, must not fully penetrate. - Test means : Rigid sphere without handle or guard. - Test force: 30 N ± 10%
3		Protection against the objects with 2.5 mm diameter or more. The object probe, sphere of 2.5 mm diameter, must not fully penetrate. - Test means : Rigid steel rod with edges free from burrs. - Test force: 3 N ± 10%
4		Protection against the objects with 1 mm diameter or more. The object probe, sphere of 1 mm diameter, must not fully penetrate. - Test means : Rigid steel rod with edges free from burrs. - Test force: 1 N ± 10%
5		Protection against the dust with or without pressure. - Dust-protected enclosures allow a limited quantity of dust to penetrate; complete protection against contact.  Test duration: 8 hours Dust (the talcum powder) : It must be able to pass a square-meshed sieve that its nominal wire with 50 µm diameter; the nominal width of a gap between wires 75 µm. The amount of talcum powder: 2 kg/m <sup>3</sup>
6		Protection against the dust under pressure. - Dust-tight enclosures do not allow any dust to penetrate.  Test duration : 2 hours (a volume of dust: 40 to 60 / hour) 8 hours (a volume of dust: less than 40 / hour) Depression : Less than 2 kPa (20 mbar) on the manometer. Dust (the talcum powder) : It must be able to pass a square-meshed sieve that its nominal wire with 50 µm diameter; the nominal width of a gap between wires 75 µm. The amount of talcum powder: 2 kg/m <sup>3</sup>

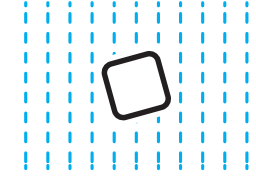
#### 2 Degree of protection against ingress of water (protected from liquids)

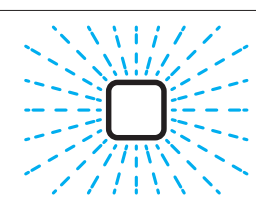
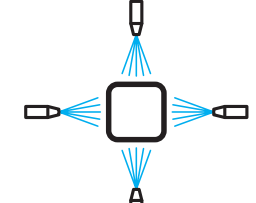
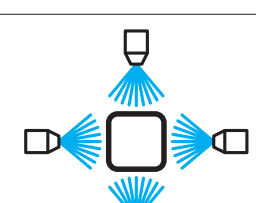
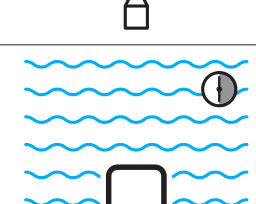
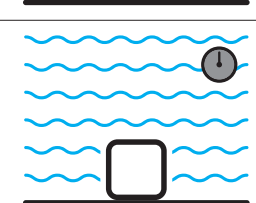
Numeral	Degree of protection	Degree of protection
0	Non-protected	
1		Protection against vertically falling water drops.  Water drops flow over the whole area of four sides on a fixed and tilting enclosure. - Test duration : 10 min (2.5 min in each of four sides)
2		Protection against vertically falling water drops when the enclosure is tilted up to 15° from its normal position.  Uniform flow of water drops over the whole area of the enclosure. - A rotation speed of turntable: 1r / min - Test duration: 10 min
3		Protection against spraying water at an angle up to 60° on either side of the vertical.  The oscillating tube has spray holes over an arc of 60° either side of the center point. It sprinkles through an angle of 120° and 60° on either side of vertical. Then, the enclosure is turned through a horizontal angle of 90°, and continue the test for 5 min. - Test duration : 10 min (5 min in each of sides) - Mean flow rate per hole: 0.07 L/min
4		Protection against splashing water from any direction. - No harmful effects on the product.  The oscillating semicircle tube with spray holes sprinkles through an angle of 360°. - Test duration: 10 min - Mean flow rate per hole: 0.07 L/min
5 <sup>01)</sup>		Protection against projecting water in jets from any direction. - No harmful effects on the product.  Spraying a stream of water from the test nozzle (internal diameter: Ø 6.3 mm) at all directions. - Test duration: 3 min - Distance from nozzle to enclosure surface : 2.5 to 3 m - Delivery rate: 12.5 L/min ± 5%
6 <sup>01)</sup>		Protection against powerfully projecting water in jets from any direction. - The product is hermetically sealed.  Spraying a stream of water from the test nozzle (internal diameter: Ø 12.5 mm) at all directions. - Test duration: 3 min - Distance from nozzle to enclosure surface : 2.5 to 3 m - Delivery rate: 100 L/min ± 5%
7 <sup>02)</sup>		Protection against temporary immersion in water under defined conditions of pressure and time. - The product is hermetically sealed.  Immersion in water under defined conditions - Test duration: 30 min - Water level: 1 m
8 <sup>02)</sup>		Complete protection against continuous immersion in water. - The product is hermetically sealed.  Immersion in water under defined conditions. - Test duration: more than 8 hours - Water level: 10 m

01) The degree of protection against spraying does not guarantee the effects of immersion.

02) The degree of protection against immersion does not guarantee the effects of spray.

## ■ DIN (Deutsche Industrie Normen) Standard

The DIN standard is defined in the DIN 40050-9.

IP 1 2

### ① Degree of protection against dust (protected from solid foreign objects)

Same as IEC standard

### ② Degree of protection against ingress of water (under high temperature and high pressure)

Letters	Degree of protection	
9K	Water resistance under high temperature and high pressure	Protection against high-temperature vapor and high-pressure water at all directions. - No harmful effects on the product.

## ■ JEM (Japan Electrical Manufacturers' Association) Standard

The JEM standard is defined in the JEM 1030.

IP 1 2 3

### ① Degree of protection against dust (protected from solid foreign objects)

Same as IEC standard

### ② Degree of protection against ingress of water (protected from liquids)

Same as IEC standard

### ③ Degree of oil proof / oil resistance

Letters	Degree of protection	
F	Oil proof type	Protection against oil drop and oil powder in all directions - Even if oil penetrates in the product, it operates normally.
G	Oil resistant type	Protection against oil drop and oil powder in all directions - Special coating prevents penetration of oil into the product.

# **Autonics**

**[www.autonics.com](http://www.autonics.com)**

Dimensions or specifications on this manual are subject to change and some models may be discontinued without notice.