

Digital Temperature Controller (Simple Type)

E5ED-800/E5ED-B-800 (48 × 96 mm)

Optimize Control by Detecting Status Changes.

Easily Satisfy Both Productivity and Quality.

Models with Push-In Plus technology Added to Lineup.

- Automatic optimization of control for changes in systems (Adaptive Control).
- Functions specialized for packaging machines (Temperature Sensors for Packaging Machines and Automatic Filter Adjustment).
- Function specialized for water-cooled extruders (Water-cooling Output Adjustment).
- Indication data (Power ON Time, Ambient Temperature, and Output ON/OFF Count).
- Basic performance is same as the E5□C-800 standard models.
- Draw-out structure for easy maintenance (Screw terminal blocks only).



48 × 96 mm
Screw Terminal Blocks
E5ED-800



48 × 96 mm
Push-In Plus Terminal Blocks
E5ED-B-800

For the most recent information on models that have been certified for safety standards, refer to your OMRON website.

Refer to *Safety Precautions* on 43.

Main I/O Functions

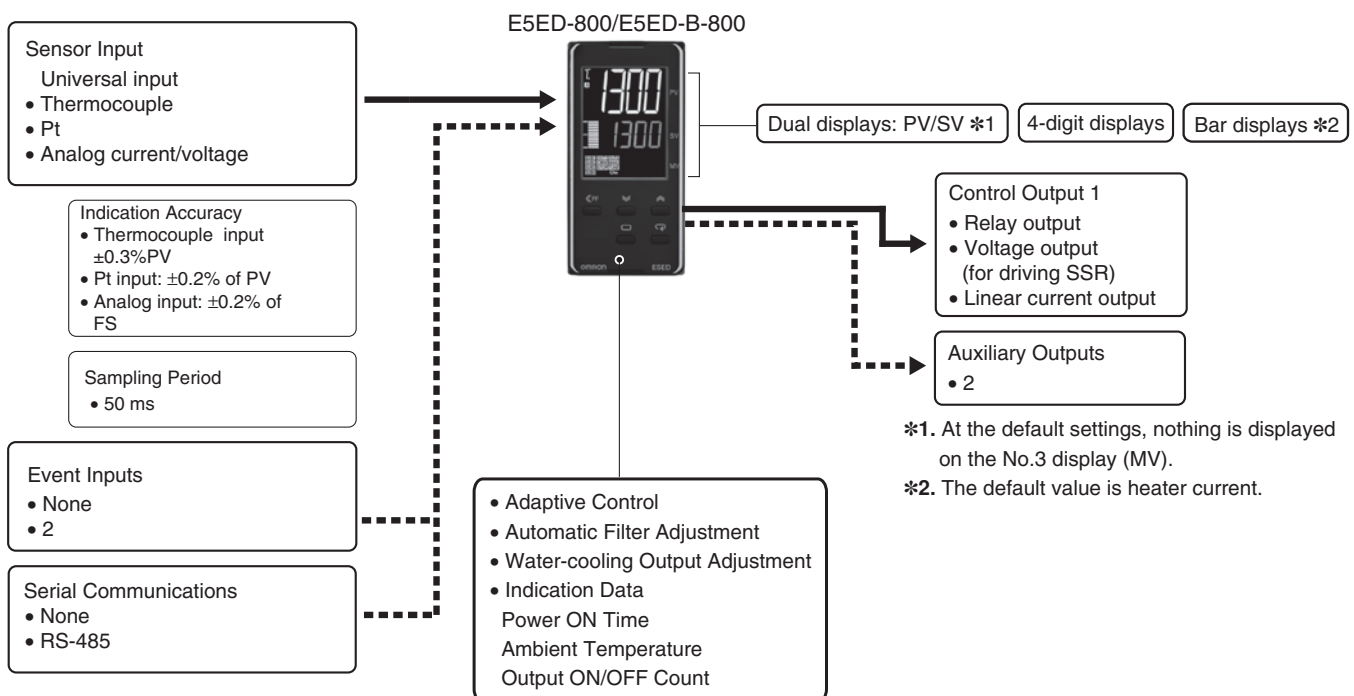

This datasheet is provided as a guideline for selecting products.

Be sure to refer to the following manuals for application precautions and other information required for operation before attempting to use the product.

E5□D Digital Temperature Controllers User's Manual (Cat. No. H224)

E5□D Digital Temperature Controllers Communications Manual (Cat. No. H225)

Model Number Legend and Standard Models

Model Number Legend

Models with Screw Terminal Blocks

E5ED-□□ 2 □ D M-□□□ (Example: E5ED-RX2ADM-800)

① ② ③ ④ ⑤ ⑥

Model	①	②	③	④	⑤	⑥	Meaning		
	Control outputs 1 and 2	No. of auxiliary outputs	Power supply voltage	Terminal type	Input type	Options			
E5ED							48 × 96 mm		
							Control output 1	Control output 2	
	RX						Relay output	None	
	QX						Voltage output (for driving SSR)	None	
	CX						Linear current output	None	
		2					2 independent outputs		
			A				100 to 240 VAC		
			D				24 VAC/DC		
				D			Screw terminal blocks, draw-out structure		
					M		Universal input		
							HB alarm and HS alarm	Communications	Event inputs
						800	---	---	---
					*1	804	---	RS-485	2
					*2	808	1	RS-485	2

*1. This option can be selected when the control output is CX.

*2. This option can be selected when the control output is RX or QX.

Heating and Cooling Control

Using Heating and Cooling Control

① Control Output Assignment

An auxiliary output is used as the cooling control output.

② Control

If PID control is used, you can set PID control separately for heating and cooling.

This allows you to handle control systems with different heating and cooling response characteristics.

List of Models

Model
E5ED-RX2ADM-800
E5ED-RX2DDM-800
E5ED-RX2ADM-808
E5ED-RX2DDM-808
E5ED-QX2ADM-800
E5ED-QX2DDM-800
E5ED-QX2ADM-808
E5ED-QX2DDM-808

Model
E5ED-CX2ADM-800
E5ED-CX2DDM-800
E5ED-CX2ADM-804
E5ED-CX2DDM-804

Model Number Legend

Models with Push-In Plus Terminal Blocks

E5ED-□□ 2 □ B M -□□□ (Example: E5ED-RX2ABM-800)

① ② ③ ④ ⑤ ⑥

Model	① Control outputs 1 and 2	② No. of auxiliary outputs	③ Power supply voltage	④ Terminal type	⑤ Input type	⑥ Options	Meaning			
E5ED							48 × 96 mm			
							Control output 1		Control output 2	
	RX						Relay output		None	
	QX						Voltage output (for driving SSR)		None	
	CX						Linear current output		None	
	QR						Voltage output (for driving SSR)		Relay output	
	RR						Relay output		Relay output	
		2					2 independent outputs			
			A				100 to 240 VAC			
			D				24 VAC/DC			
				B			Push-In Plus terminal block			
					M		Universal input			
							HB alarm and HS alarm	Communications	Event inputs	Transfer Output
						800	---	---	---	---
					*1	804	---	RS-485	2	---
					*2	808	1	RS-485	2	---

*1. This option can be selected when the control output is CX.

*2. This option can be selected when the control output is RX, QX, QR, or RR.

Heating and Cooling Control

Using Heating and Cooling Control

① Control Output Assignment

If there is no control output 2, an auxiliary output is used as the cooling control output.

If there is a control output 2, the two control outputs are used for heating and cooling. (It does not matter which output is used for heating and which output is used for cooling.)

② Control

If PID control is used, you can set PID control separately for heating and cooling.

This allows you to handle control systems with different heating and cooling response characteristics.

List of Models

Model	Model
E5ED-RX2ABM-800	E5ED-CX2ABM-800
E5ED-RX2DBM-800	E5ED-CX2DBM-800
E5ED-RX2ABM-808	E5ED-CX2ABM-804
E5ED-RX2DBM-808	E5ED-CX2DBM-804
E5ED-QX2ABM-800	E5ED-RR2ABM-800
E5ED-QX2DBM-800	E5ED-RR2ABM-808
E5ED-QX2ABM-808	E5ED-QR2ABM-800
E5ED-QX2DBM-808	E5ED-QR2ABM-808

Optional Products (Order Separately)

Terminal Covers

(Cannot be used on a Push-In Plus terminal block type)

Model
E53-COV24 (3pcs)

Waterproof Packing

Model
Y92S-P9

Note: This Waterproof Packing is provided with the Digital Temperature Controller.

Waterproof Cover

Model
Y92A-49N

Mounting Adapter

Model
Y92F-51 (2pcs)

Note: This Mounting Adapter is provided with the Digital Temperature Controller.

Current Transformers (CTs)

Hole diameter	Model
5.8 mm	E54-CT1
5.8 mm	E54-CT1L*
12.0 mm	E54-CT3
12.0 mm	E54-CT3L*

*Lead wires are included with these CTs. If UL certification is required, use these CTs.

Draw-out Jig

(Cannot be used on a Push-In Plus terminal block type)

Model
Y92F-59

E5ED-800/E5ED-B-800

Specifications

Ratings

Power supply voltage		A in model number: 100 to 240 VAC, 50/60 Hz D in model number: 24 VAC, 50/60 Hz; 24 VDC
Operating voltage range		85% to 110% of rated supply voltage
Power consumption		Models with option selection of 800: 6.6 VA max. at 100 to 240 VAC, and 4.1 VA max. at 24 VAC or 2.3 W max. at 24 VDC All other models: 8.3 VA max. at 100 to 240 VAC, and 5.5 VA max. at 24 VAC or 3.2 W max. at 24 VDC
Sensor input		Temperature input Thermocouple: K, J, T, E, L, U, N, R, S, B, C/W, or PL II Platinum resistance thermometer: Pt100 or JPt100 Infrared temperature sensor (ES1B): 10 to 70°C, 60 to 120°C, 115 to 165°C, or 140 to 260°C Analog input Current input: 4 to 20 mA or 0 to 20 mA Voltage input: 1 to 5 V, 0 to 5 V, or 0 to 10 V
Input impedance		Current input: 150 Ω max., Voltage input: 1 MΩ min. (Use a 1:1 connection when connecting the ES2-HB-N/THB-N)
Control method		ON/OFF control or 2-PID control (with auto-tuning)
Control output	Relay output	SPST-NO, 250 VAC, 5 A (resistive load), electrical life: 100,000 operations, minimum applicable load: 5 V, 10 mA (reference value)
	Voltage output (for driving SSR)	Output voltage: 12 VDC ±20% (PNP), max. load current: 40 mA, with short-circuit protection circuit
	Linear current output	4 to 20 or 0 to 20 mA DC, Load: 500 Ω max., Resolution: Approx. 10,000
Auxiliary output	Number of outputs	2
	Output specifications	SPST-NO relay outputs, 250 VAC, 2 A (resistive load) Electrical life: 100,000 operations, Minimum applicable load: 10 mA at 5 V (reference values)
Event input	Number of inputs	2
	External contact input specifications	Contact input: ON: 1 kΩ max., OFF: 100 kΩ min.
		Non-contact input: ON: Residual voltage: 1.5 V max., OFF: Leakage current: 0.1 mA max. Current flow: Approx. 7 mA per contact
Setting method		Digital setting using front panel keys
Indication method		11-segment digital display, individual indicators, and bar display Character height: PV: 18.0 mm, SV: 11.0 mm, MV: 7.8 mm Three displays Contents: PV/SV/MV, PV/SV/Multi-SP, PV/SV/Remaining soak time, etc. Numbers of digits: 4 digits each for PV, SV, and MV displays
Multi SP		Up to eight set points (SP0 to SP7) can be saved and selected using the event inputs, key operations, or serial communications.
Bank switching		None
Other functions		Adaptive control, automatic filter adjustment, water-cooling output adjustment, indication data (power ON time monitor, ambient temperature monitor, and control output ON/OFF count monitors), parameter masking, operation after power ON, manual output, heating/cooling control, loop burnout alarm, SP ramp, other alarm functions, heater burnout (HB) alarm (including SSR failure (HS) alarm), 40% AT, 100% AT, MV limiter, input digital filter, robust tuning, PV input shift, run/stop, protection functions, extraction of square root, MV change rate limit, logic operations, temperature status display, simple programming, moving average of input value, and display brightness setting
Ambient operating temperature		-10 to 55°C (with no condensation or icing), For 3-year warranty: -10 to 50°C with standard mounting (with no condensation or icing)
Ambient operating humidity		25% to 85%
Storage temperature		-25 to 65°C (with no condensation or icing)
Altitude		2,000 m max.
Recommended fuse		T2A, 250 VAC, time-lag, low-breaking capacity
Installation environment		Overvoltage category II, Pollution Degree 2 (EN/IEC/UL 61010-1)

Alarm Types

Each alarm can be independently set to one of the following 17 alarm types. The default is 2: Upper limit. (see note.)

Auxiliary outputs are allocated for alarms. ON delays and OFF delays (0 to 999 s) can also be specified.

Note: In the default settings for models with HB or HS alarms, alarm 1 is set to a heater alarm (HA) and the Alarm Type 1 parameter is not displayed. To use alarm 1, set the output assignment to alarm 1.

Set value	Alarm type	Alarm output operation		Description of function
		When alarm value X is positive	When alarm value X is negative	
0	Alarm function OFF	Output OFF		No alarm
1	Upper- and lower-limit *1		*2	Set the upward deviation in the set point for the alarm upper limit (H) and the lower deviation in the set point for the alarm lower limit (L). The alarm is ON when the PV is outside this deviation range.
2 (default)	Upper-limit			Set the upward deviation in the set point by setting the alarm value (X). The alarm is ON when the PV is higher than the SP by the deviation or more.
3	Lower-limit			Set the downward deviation in the set point by setting the alarm value (X). The alarm is ON when the PV is lower than the SP by the deviation or more.
4	Upper- and lower-limit range *1		*3	Set the upward deviation in the set point for the alarm upper limit (H) and the lower deviation in the set point for the alarm lower limit (L). The alarm is ON when the PV is inside this deviation range.
5	Upper- and lower-limit with standby sequence *1	*5	*4	A standby sequence is added to the upper- and lower-limit alarm (1). *6
6	Upper-limit with standby sequence			A standby sequence is added to the upper-limit alarm (2). *6
7	Lower-limit with standby sequence			A standby sequence is added to the lower-limit alarm (3). *6
8	Absolute-value upper-limit			The alarm will turn ON if the process value is larger than the alarm value (X) regardless of the set point.
9	Absolute-value lower-limit			The alarm will turn ON if the process value is smaller than the alarm value (X) regardless of the set point.
10	Absolute-value upper-limit with standby sequence			A standby sequence is added to the absolute-value upper-limit alarm (8). *6
11	Absolute-value lower-limit with standby sequence			A standby sequence is added to the absolute-value lower-limit alarm (9). *6
12	LBA (alarm 1 type only)	-		*7
13	PV change rate alarm	-		*8
14	SP absolute-value upper-limit alarm			This alarm type turns ON the alarm when the set point (SP) is higher than the alarm value (X).
15	SP absolute-value lower-limit alarm			This alarm type turns ON the alarm when the set point (SP) is lower than the alarm value (X).
16	MV absolute-value upper-limit alarm *9	Standard Control 	Standard Control 	This alarm type turns ON the alarm when the manipulated variable (MV) is higher than the alarm value (X).
		Heating/Cooling Control (Heating MV) 	Heating/Cooling Control (Heating MV) 	
		Always ON		
17	MV absolute-value lower-limit alarm *9	Standard Control 	Standard Control 	This alarm type turns ON the alarm when the manipulated variable (MV) is lower than the alarm value (X).
		Heating/Cooling Control (Cooling MV) 	Heating/Cooling Control (Cooling MV) 	
		Always ON		

*1. With set values 1, 4 and 5, the upper and lower limit values can be set independently for each alarm type, and are expressed as "L" and "H."

*2. Set value: 1, Upper- and lower-limit alarm

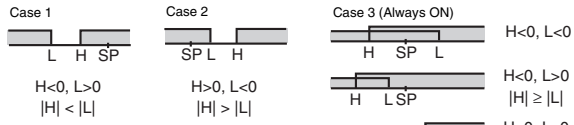

*3. Set value: 4, Upper- and lower-limit range

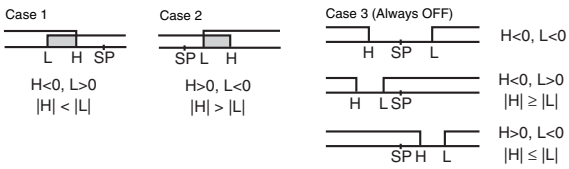

*4. Set value: 5, Upper- and lower-limit with standby sequence
For Upper- and Lower-Limit Alarm Described Above *2

- Case 1 and 2
Always OFF when the upper-limit and lower-limit hysteresis overlaps.
- Case 3: Always OFF

*5. Set value: 5, Upper- and lower-limit with standby sequence
Always OFF when the upper-limit and lower-limit hysteresis overlaps.

*6. Refer to the *E5ED Digital Temperature Controllers User's Manual* (Cat. No. H224) for information on the operation of the standby sequence.

*7. Refer to the *E5ED Digital Temperature Controllers User's Manual* (Cat. No. H224) for information on the loop burnout alarm (LBA).

*8. Refer to the *E5ED Digital Temperature Controllers User's Manual* (Cat. No. H224) for information on the PV change rate alarm.

*9. When heating/cooling control is performed, the MV absolute upper limit alarm functions only for the heating operation and the MV absolute lower limit alarm functions only for the cooling operation.

Characteristics

Indication accuracy (at the ambient temperature of 23°C)		Thermocouple: ($\pm 0.3\%$ of indication value or $\pm 1^\circ\text{C}$, whichever is greater) ± 1 digit max. *1 Platinum resistance thermometer: ($\pm 0.2\%$ of indication value or $\pm 0.8^\circ\text{C}$, whichever is greater) ± 1 digit max. Analog input: $\pm 0.2\%$ FS ± 1 digit max. CT input: $\pm 5\%$ FS ± 1 digit max.
Influence of temperature *2		Thermocouple input (R, S, B, C/W, PL II): ($\pm 1\%$ of indication value or $\pm 10^\circ\text{C}$, whichever is greater) ± 1 digit max.
Influence of voltage *2		Other thermocouple input: ($\pm 1\%$ of indication value or $\pm 4^\circ\text{C}$, whichever is greater) ± 1 digit max. *3
Influence of EMS. (at EN 61326-1)		Platinum resistance thermometer: ($\pm 1\%$ of indication value or $\pm 2^\circ\text{C}$, whichever is greater) ± 1 digit max. Analog input: $\pm 1\%$ FS ± 1 digit max. CT input: $\pm 5\%$ FS ± 1 digit max.
Input sampling period		50 ms
Hysteresis		Temperature input: 0.1 to 999.9°C or °F (in units of 0.1°C or °F) Analog input: 0.01% to 99.99% FS (in units of 0.01% FS)
Proportional band (P)		Temperature input: 0.1 to 999.9°C or °F (in units of 0.1°C or °F) Analog input: 0.1% to 999.9% FS (in units of 0.1% FS)
Integral time (I)		0 to 9999 s (in units of 1 s), 0.0 to 999.9 s (in units of 0.1 s) *4
Derivative time (D)		0 to 9999 s (in units of 1 s), 0.0 to 999.9 s (in units of 0.1 s) *4
Proportional band (P) for cooling		Temperature input: 0.1 to 999.9°C or °F (in units of 0.1°C or °F) Analog input: 0.1% to 999.9% FS (in units of 0.1% FS)
Integral time (I) for cooling		0 to 9999 s (in units of 1 s), 0.0 to 999.9 s (in units of 0.1 s) *4
Derivative time (D) for cooling		0 to 9999 s (in units of 1 s), 0.0 to 999.9 s (in units of 0.1 s) *4
For adaptive control	SP response proportional band	Temperature input: 0.1 to 999.9°C or °F (in units of 0.1°C or °F)
	SP response integral time	0 to 9999 s (in units of 1 s), 0.0 to 999.9 s (in units of 0.1 s) *4
	SP response derivative time	0 to 9999 s (in units of 1 s), 0.0 to 999.9 s (in units of 0.1 s) *4
	Disturbance proportional band	Temperature input: 0.1 to 999.9°C or °F (in units of 0.1°C or °F)
	Disturbance integral time	0 to 9999 s (in units of 1 s), 0.0 to 999.9 s (in units of 0.1 s) *4
	Disturbance derivative time	0 to 9999 s (in units of 1 s), 0.0 to 999.9 s (in units of 0.1 s) *4
Control period		0.1, 0.2, 0.5, 1 to 99 s (in units of 1 s)
Manual reset value		0.0 to 100.0% (in units of 0.1%)
Alarm setting range		-1999 to 9999 (decimal point position depends on input type)
Influence of signal source resistance		Thermocouple: 0.1°C/Ω max. (100 Ω max.) Platinum resistance thermometer: 0.1°C/Ω max. (10 Ω max.)
Insulation resistance		20 MΩ min. (at 500 VDC)
Dielectric strength		3,000 VAC, 50/60 Hz for 1 min between terminals of different charge
Vibration	Malfunction	10 to 55 Hz, 20 m/s ² for 10 min each in X, Y, and Z directions
	Resistance	10 to 55 Hz, 20 m/s ² for 2 hrs each in X, Y, and Z directions
Shock	Malfunction	100 m/s ² , 3 times each in X, Y, and Z directions
	Resistance	300 m/s ² , 3 times each in X, Y, and Z directions
Weight		Controller: Approx. 210 g, Mounting Adapter: Approx. 4 g × 2
Degree of protection		Front panel: IP66, Rear case: IP20, Terminals: IP00
Memory protection		Non-volatile memory (number of writes: 1,000,000 times)
Standards	Approved standards	cULus: UL 61010-1/CSA C22.2 No.61010-1, Korean wireless regulations (Radio law: KC Mark)
	Conformed standards	EN 61010-1 (IEC 61010-1) and RCM standards
EMC		EMI: Radiated Interference Electromagnetic Field Strength: EN 55011 Group 1, class A Noise Terminal Voltage: EN 55011 Group 1, class A EMS: ESD Immunity: EN 61326-1 *5 EN 61000-4-2 Electromagnetic Field Immunity: EN 61000-4-3 Burst Noise Immunity: EN 61000-4-4 Conducted Disturbance Immunity: EN 61000-4-6 Surge Immunity: EN 61000-4-5 Voltage Dip/Interrupting Immunity: EN 61000-4-11

*1. The indication accuracy of K thermocouples in the -200 to 1,300°C range, T and N thermocouples at a temperature of -100°C max., and U and L thermocouples at any temperatures is $\pm 2^\circ\text{C} \pm 1$ digit max. The indication accuracy of the B thermocouple at a temperature of 400°C max. is not specified. The indication accuracy of B thermocouples at a temperature of 400 to 800°C is $\pm 3^\circ\text{C}$ max. The indication accuracy of the R and S thermocouples at a temperature of 200°C max. is $\pm 3^\circ\text{C} \pm 1$ digit max. The indication accuracy of C/W thermocouples is ($\pm 0.3\%$ of PV or $\pm 3^\circ\text{C}$, whichever is greater) ± 1 digit max. The indication accuracy of PL II thermocouples is ($\pm 0.3\%$ of PV or $\pm 2^\circ\text{C}$, whichever is greater) ± 1 digit max.

*2. Ambient temperature: -10°C to 23°C to 55°C, Voltage range: -15% to 10% of rated voltage

*3. K thermocouple at -100°C max.: $\pm 10^\circ\text{C}$ max.

*4. The unit is determined by the setting of the Integral/Derivative Time Unit parameter.

*5. Industrial electromagnetic environment (EN/IEC 61326-1 Table 2)

Communications Specifications

Transmission line connection method	RS-485: Multidrop
Communications	RS-485 (two-wire, half duplex)
Synchronization method	Start-stop synchronization
Protocol	CompoWay/F, or Modbus
Baud rate *	9,600, 19,200, 38,400, 57,600, or 115,200 bps
Transmission code	ASCII
Data bit length *	7 or 8 bits
Stop bit length *	1 or 2 bits
Error detection	Vertical parity (none, even, odd) Block check character (BCC) with CompoWay/F or CRC-16 Modbus
Flow control	None
Interface	RS-485
Retry function	None
Communications buffer	217 bytes
Communications response wait time	0 to 99 ms Default: 20 ms

* The baud rate, data bit length, stop bit length, and vertical parity can be individually set using the Communications Setting Level.

Communications Functions

Programless communications	You can use the memory in the PLC to read and write E5ED-800/E5ED-B-800 parameters, start and stop operation, etc. The E5ED-800/E5ED-B-800 automatically performs communications with PLCs. No communications programming is required. Number of connected Digital Temperature Controllers: 32 max. (Up to 16 for the FX3) Applicable PLCs OMRON PLCs CS Series, CJ Series, CP Series, NJ Series, or NX1P Mitsubishi Electric PLCs MELSEC Q Series, L Series, FX3 Series, or iQ-R Series KEYENCE PLCs KEYENCE KV Series
Copying *	When Digital Temperature Controllers are connected, the parameters can be copied from the Digital Temperature Controller that is set as the master to the Digital Temperature Controllers that are set as slaves.

MELSEC is a registered trademark of Mitsubishi Electric Corporation.
KEYENCE is a registered trademark of Keyence Corporation.

*Programless communications supports the copying function.

Current Transformer (Order Separately) Ratings

	E54-CT1 E54-CT3	E54-CT1L E54-CT3L
Dielectric strength	1,000 VAC for 1 min	1,500 VAC for 1 min
Vibration resistance	50 Hz, 98 m/s ²	
Weight	E54-CT1: Approx. 11.5 g E54-CT3: Approx. 50 g	E54-CT1L: Approx. 14 g E54-CT3L: Approx. 57 g
Accessories	E54-CT3 Only Armatures (2) Plugs (2)	None

Heater Burnout Alarms and SSR Failure Alarms

CT input (for heater current detection)	Models with detection for single-phase heaters: One input
Maximum heater current	50 A AC
Input current indication accuracy	±5% FS ±1 digit max.
Heater burnout alarm setting range *1	0.1 to 49.9 A (in units of 0.1 A) Minimum detection ON time: 100 ms *3
SSR failure alarm setting range *2	0.1 to 49.9 A (in units of 0.1 A) Minimum detection OFF time: 100 ms *4

*1. For heater burnout alarms, the heater current will be measured when the control output is ON, and the output will turn ON if the heater current is lower than the set value (i.e., heater burnout detection current value).

*2. For SSR failure alarms, the heater current will be measured when the control output is OFF, and the output will turn ON if the heater current is higher than the set value (i.e., SSR failure detection current value).

*3. The value is 30 ms for a control period of 0.1 s or 0.2 s.

*4. The value is 38 ms for a control period of 0.1 s or 0.2 s.

Electrical Life Expectancy Curve for Control Output Relay (Reference Values)

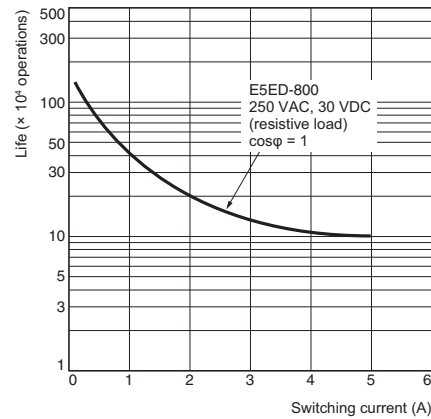

E5ED-800/E5ED-B-800

External Connections

E5ED-800

E5ED-□□ 2 □ D M - □□□
 (1) (2) (3) (4) (5) (6)
 ↑
 Terminal type

The E5ED-800 is set for a K-type thermocouple (input type = 5) by default. An input error (5.ERR) will occur if the input type setting does not agree with the temperature sensor. Check the input type.

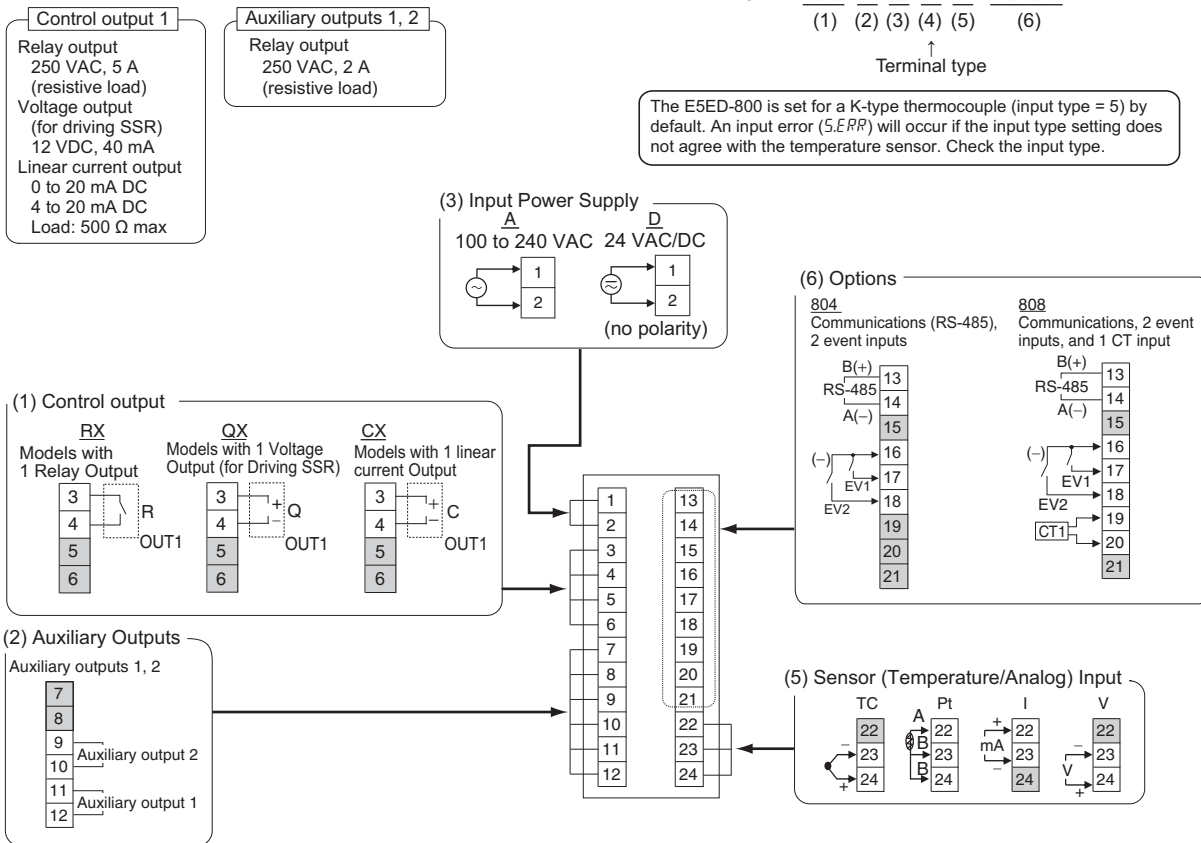

- Note:**
- The application of the terminals depends on the model.
 - Do not wire the terminals that are shown with a gray background.
 - When complying with EMC standards, the cable that connects the sensor must be 30 m or less. If the cable length exceeds 30 m, compliance with EMC standards will not be possible.
 - Connect M3 crimped terminals.
 - Due to UL Listing requirements, use the E54-CT1L or E54-CT3L Current Transformer with the factory wiring (internal wiring). Use a UL category XOBA or XOBA7 current transformer that is UL Listed for field wiring (external wiring) and not the factory wiring (internal wiring).

E5ED-B-800 (Push-In Plus Terminal Blocks)

Control output 1

Relay output
250 VAC, 5 A (resistive load)
Voltage output
(for driving SSR)
12 VDC, 40 mA
When There Is a Control Output 2: 21 mA
Linear current output
0 to 20 mA DC
4 to 20 mA DC
Load: 500 Ω max

Control output 2

Relay output
250 VAC, 5 A
(resistive load)

Auxiliary outputs 1, 2, 3, 4

Relay output
Models with 4 auxiliary outputs
250 VAC, 2 A (resistive load)

E5ED-□□ 2 □ B M - □□□
(1) (2) (3) (4) (5) (6)

↑
Terminal type

The E5ED-B-800 is set for a K-type thermocouple (input type = 5) by default. An input error (5.EPP) will occur if the input type setting does not agree with the temperature sensor. Check the input type.

(1) Control output

RX
Models with 1 Relay Output

QX
Models with 1 Voltage Output (for Driving SSR)

CX
Models with 1 linear current Output

QR
Models with Voltage Output (for Driving SSR) and Relay Output

RR
Models with 2 Relay Outputs

(3) Input Power Supply

100 to 240 VAC

24 VAC/DC

(no polarity)

(6) Options

804
Communications, 2 event inputs

808
Communications, 2 event inputs, and 1 CT input

(2) Auxiliary Outputs

Auxiliary outputs 1 and 2

Auxiliary output 2

Auxiliary output 1

(5) Sensor (Temperature/Analog) Input

TC Pt I V

Use non-voltage inputs for the event inputs.
The polarity for a non-contact input is indicated by "(-)."

- Note:**
- The application of the terminals depends on the model.
 - Do not wire the terminals that are shown with a gray background.
 - When complying with EMC standards, the cable that connects the sensor must be 30 m or less. If the cable length exceeds 30 m, compliance with EMC standards will not be possible.
 - Refer to E5ED-B (Push-In Plus terminal block types) on page 48 for wire specifications and wiring methods.
 - Common terminals are indicated with asterisks (*).
You can use the input power supply and communications common terminals for crossover wiring. Controllers given below if you use crossover wiring for the input power supply.
100 to 240 VAC Controllers: 16 max.
24 VAC/VDC Controllers: 8 max.

Wiring Example:

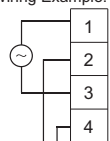

To another E5ED-B

- Due to UL Listing requirements, use the E54-CT1L or E54-CT3L Current Transformer with the factory wiring (internal wiring). Use a UL category X0BA or X0BA7 current transformer that is UL Listed for field wiring (external wiring) and not the factory wiring (internal wiring).

E5ED-800/E5ED-B-800

Isolation/Insulation Block Diagrams

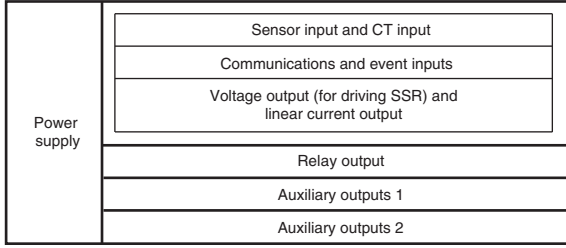

: Reinforced insulation
 : Functional isolation

Nomenclature

E5ED-800/E5ED-B-800

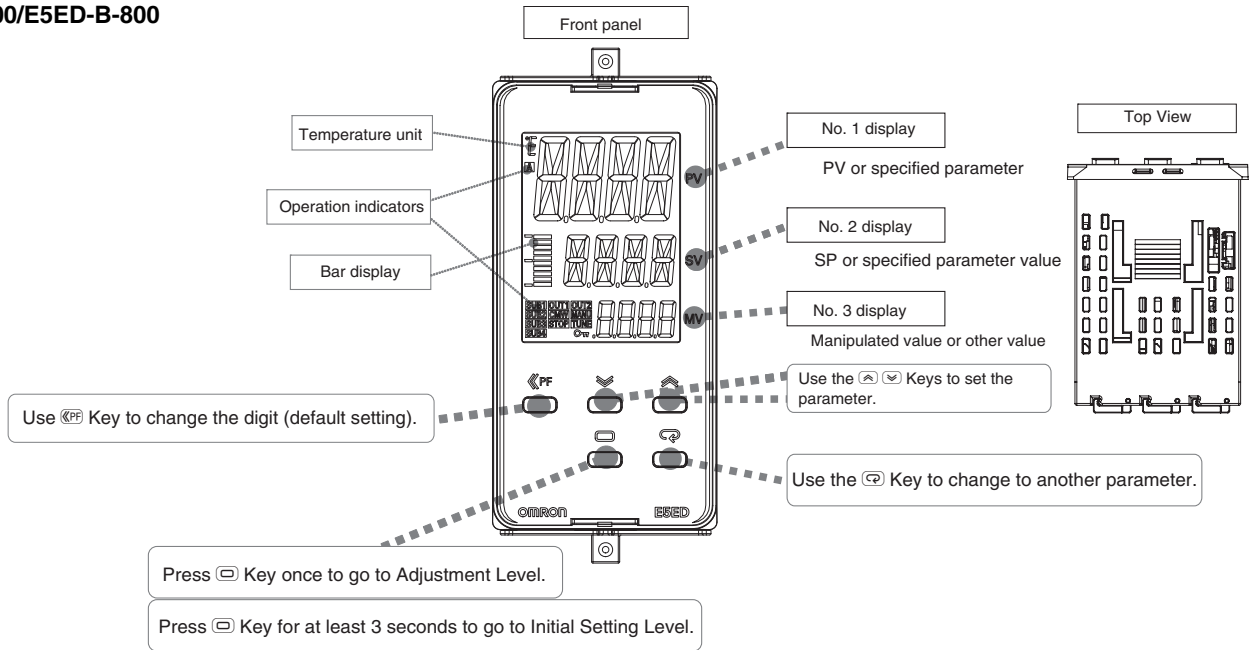

Dimensions

(Unit: mm)

Controllers

E5ED-800

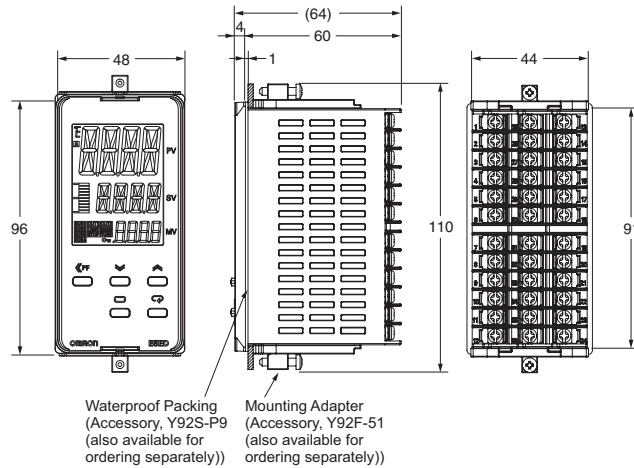

E5ED-B-800

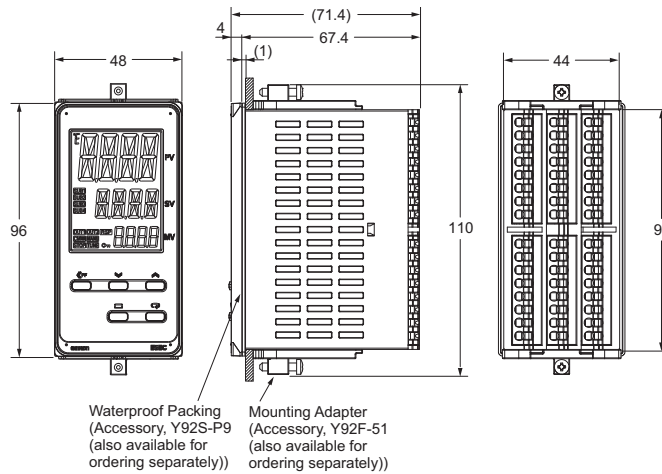

Mounted Separately

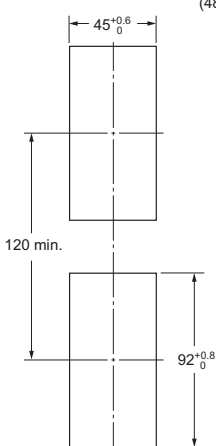

Group Mounted

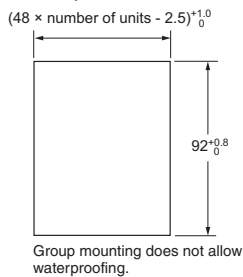

* Selections for Control Outputs 1 and 2: QR or RR

If you also specify 022 for the option selection and use group mounting, the ambient temperature must be 45°C or less. Maintain the following spacing when more than one Digital Controller is installed at an ambient temperature of 55°C.

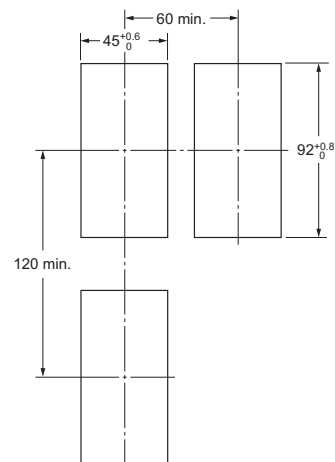

- Recommended panel thickness is 1 to 8 mm.
- Group mounting is not possible in the vertical direction. (Maintain the specified mounting space between Controllers.)
- To mount the Controller so that it is waterproof, insert the waterproof packing onto the Controller.
- When two or more Controllers are mounted, make sure that the surrounding temperature does not exceed the allowable operating temperature specified in the specifications.

Accessories (Order Separately)

Terminal Covers (Cannot be used on a Push-In Plus terminal block type)
E53-COV24 (Three Covers provided.)

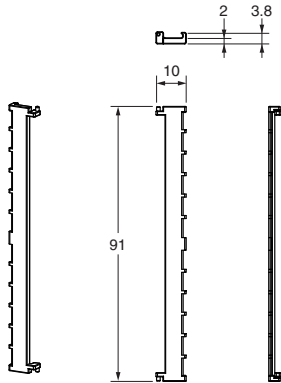

Waterproof Packing

Y92S-P9 (for DIN 48 × 96)

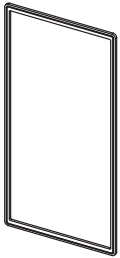

The Waterproof Packing is provided with the Digital Temperature Controller. Order the Waterproof Packing separately if it becomes lost or damaged. The Waterproof Packing can be used to achieve an IP66 degree of protection. Also, keep the Port Cover on the front-panel Setup Tool port of the E5ED/E5ED-B-800 securely closed.

(Deterioration, shrinking, or hardening of the waterproof packing may occur depending on the operating environment. Therefore, periodic replacement is recommended to ensure the level of waterproofing specified in IP66. The time for periodic replacement depends on the operating environment. Be sure to confirm this point at your site. Consider three years as a rough standard.)

Mounting Adapter

Y92F-51 (Two Adapters provided.)

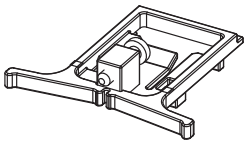

One pair is provided with the Controller.
Order this Adapter separately if it becomes lost or damaged.

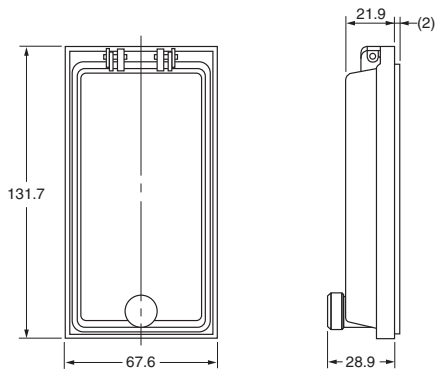
Waterproof Cover
Y92A-49N (for DIN 48 × 96)**Draw-out Jig** (Cannot be used on a Push-In Plus terminal block type)
Y92F-59

Use this Draw-out Jig to remove the interior body of the Digital Temperature Controller from the case to perform maintenance without removing the terminal wiring.

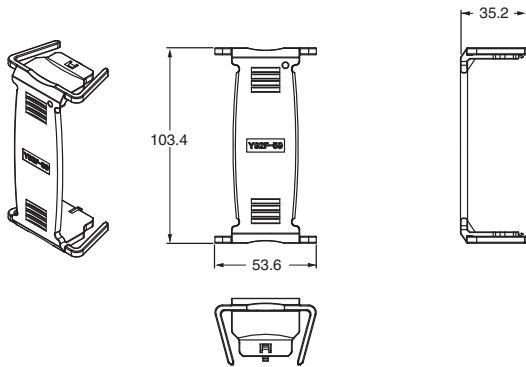

E54-CT3

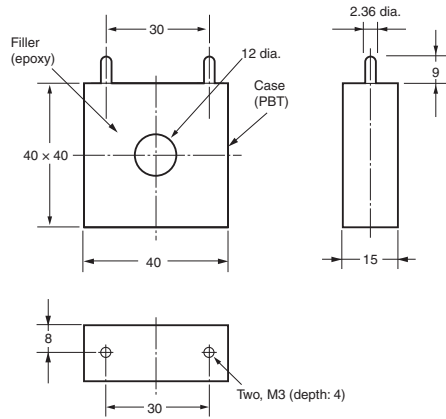

**Thru-current (I_o) vs. Output Voltage (E_o)
(Reference Values)
E54-CT3 or E54-CT3L**

Maximum continuous heater current: 120 A (50/60 Hz)
 (Maximum continuous heater current for an OMRON Digital Temperature Controller is 50 A.)
 Number of windings: 400 ± 2
 Winding resistance: $8 \pm 0.8 \Omega$

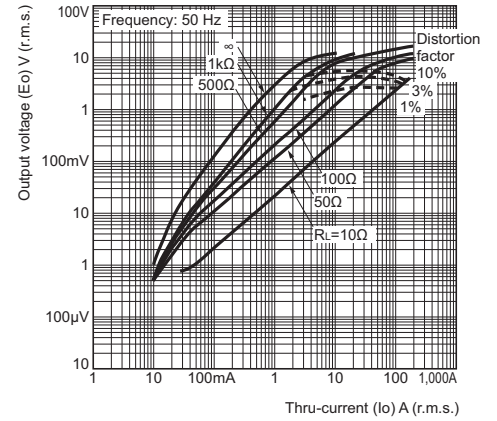

E54-CT3 Accessories

• Armature

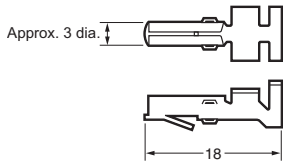

Connection Example

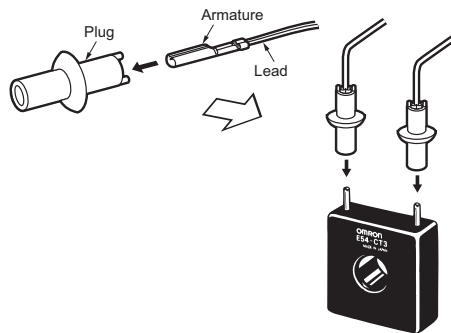

• Plug

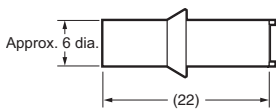

E54-CT3L

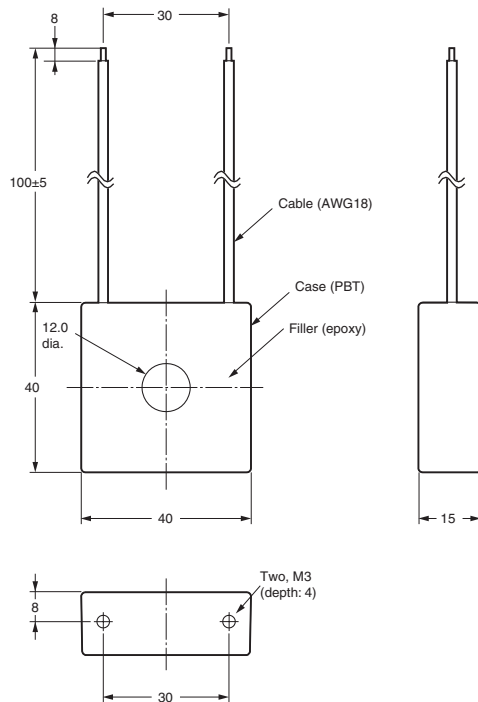

Operation

Setting Levels Diagram

This diagram shows all of the setting levels. To move to the advanced function setting level and calibration level, you must enter passwords. Some parameters are not displayed depending on the protect level setting and the conditions of use. Control stops when you move from the operation level to the initial setting level.

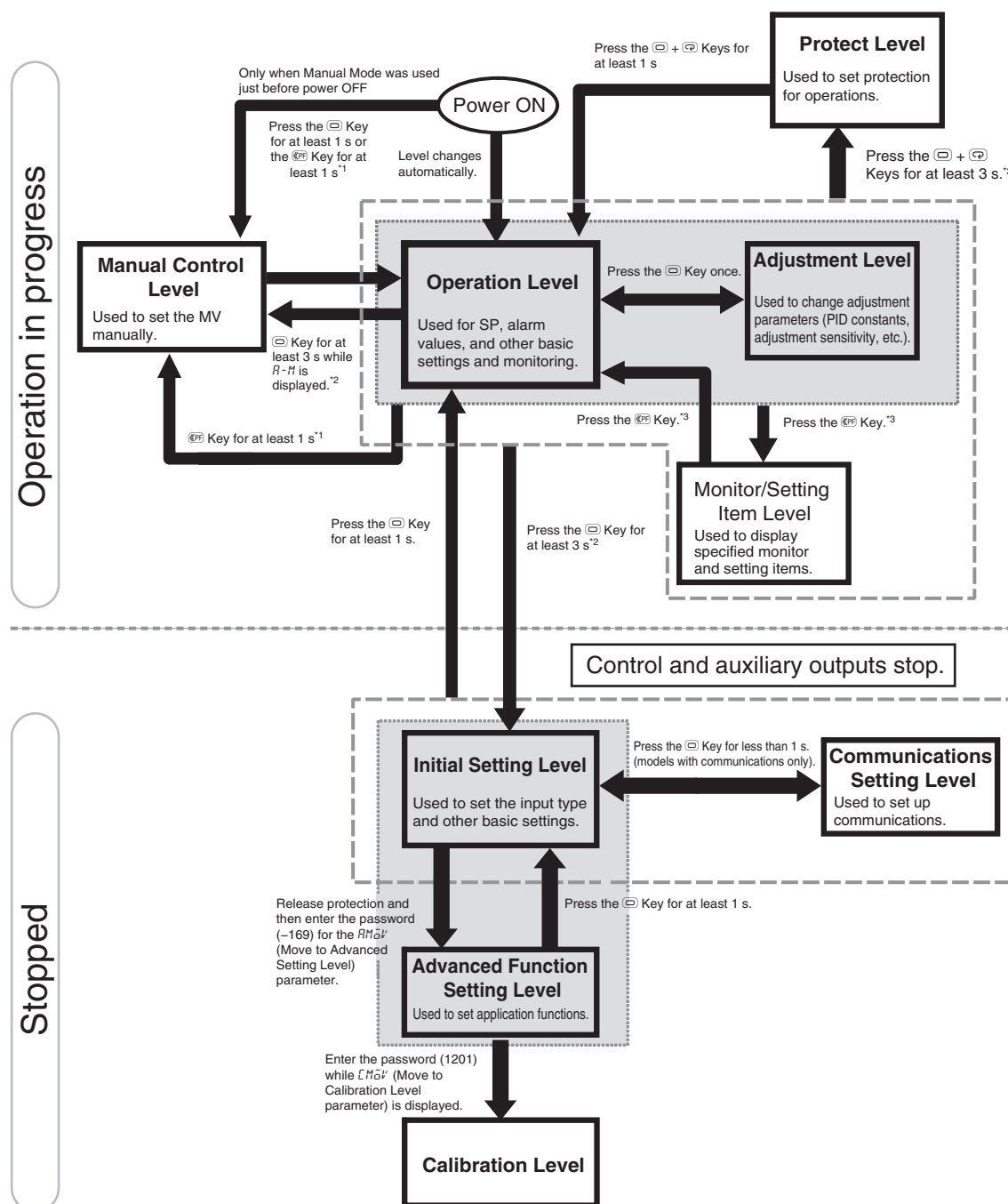

*1. Set the PF Setting parameter to $R-M$ (Auto/Manual).

*2. The No. 1 display will flash when the keys are pressed for 1 s or longer.

*3. Set the PF Setting parameter to $PFdP$ (monitor/setting items).

Parameter Flow

This section describes the parameters set in each level. Pressing the **MODE** (Mode) Key at the last parameter in each level returns to the top parameter in that level. Hold down the **MODE** Key to move through the parameters in reverse. Some parameters may not be displayed depending on the model and other settings.

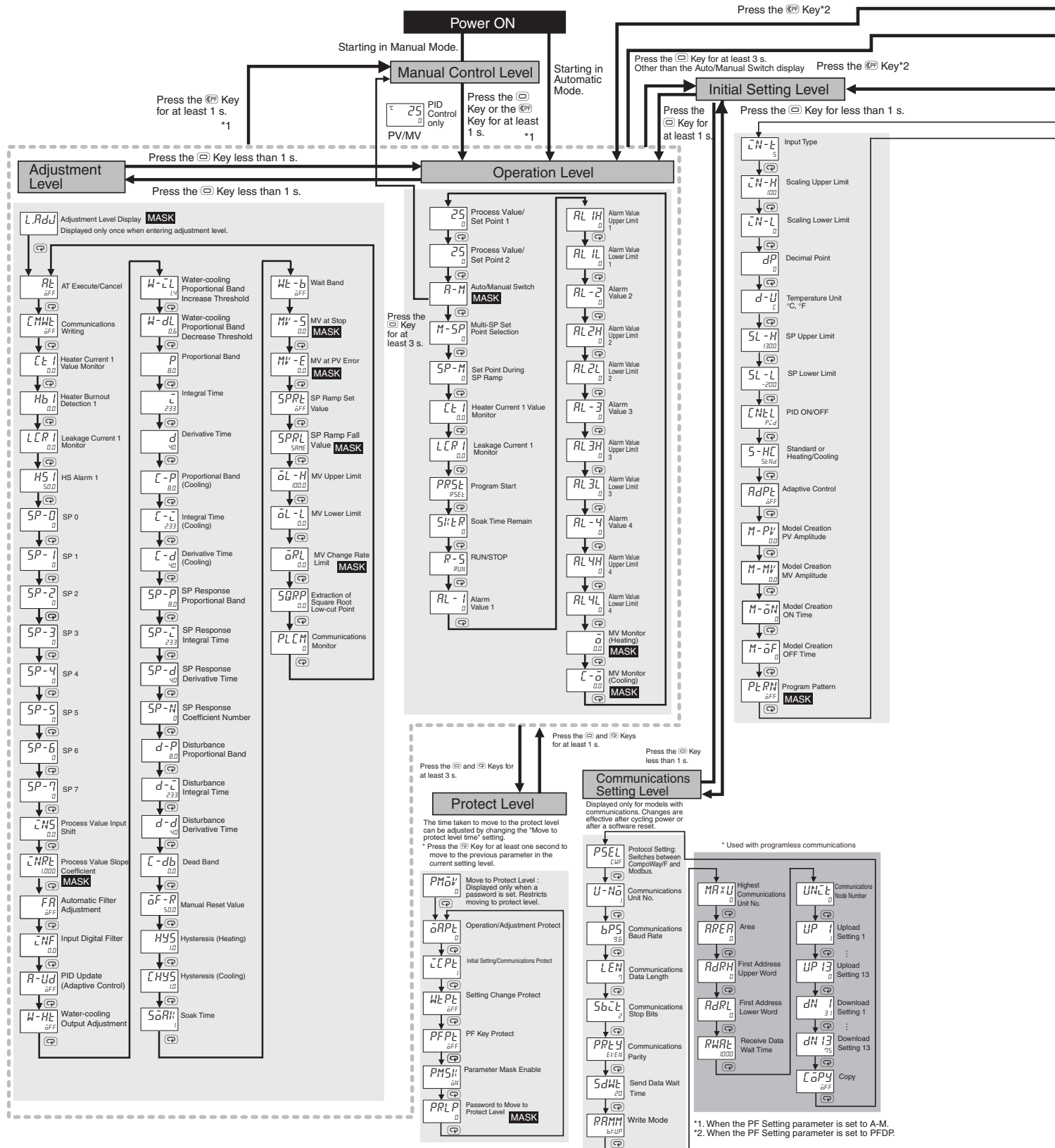

MASK This mark indicates masked parameters. Disable the mask to display the parameter. Refer to 5-12 Hiding Parameters in the E5□D Digital Temperature Controller User's Manual (Cat. No. H224).

Monitor/Setting Item Level

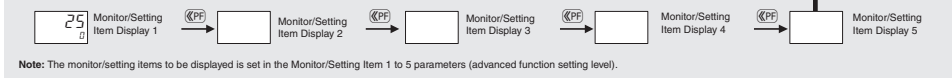

Press the  Key for at least 1 s.

Advanced Function Setting Level

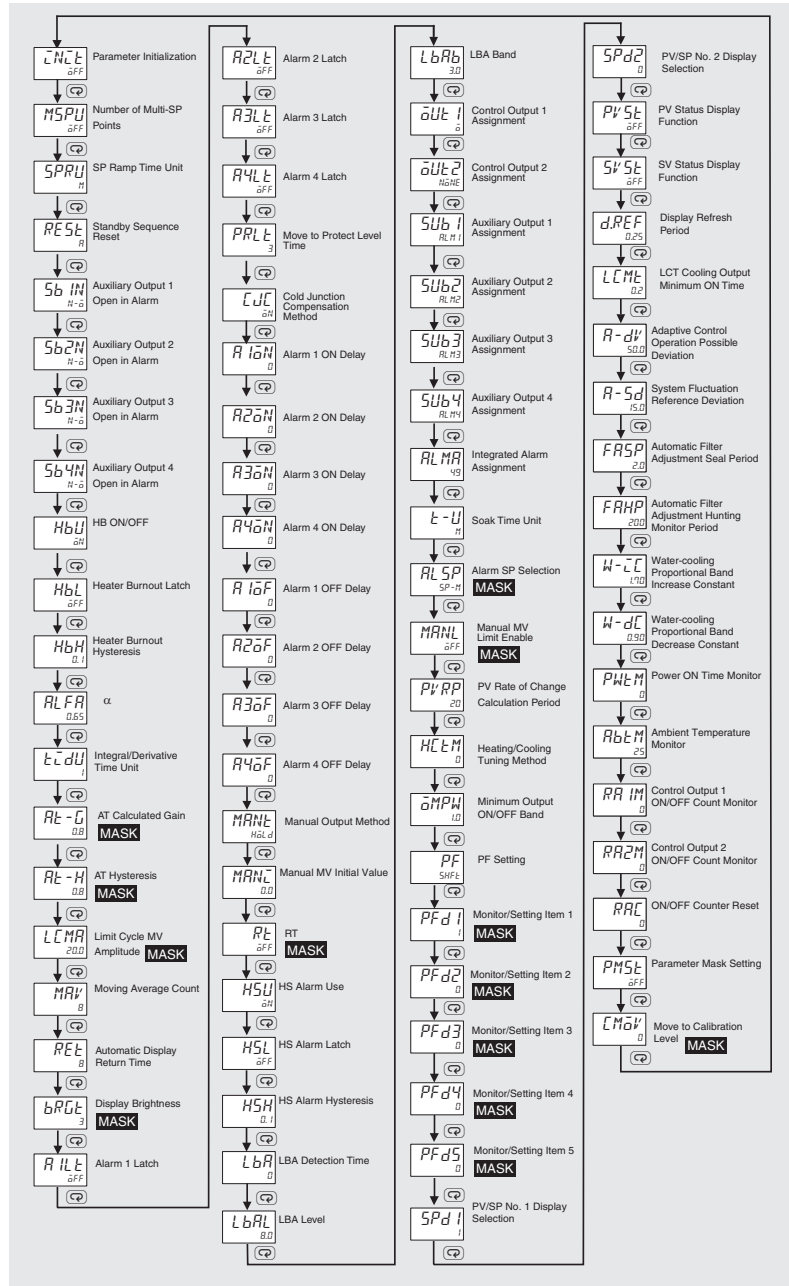
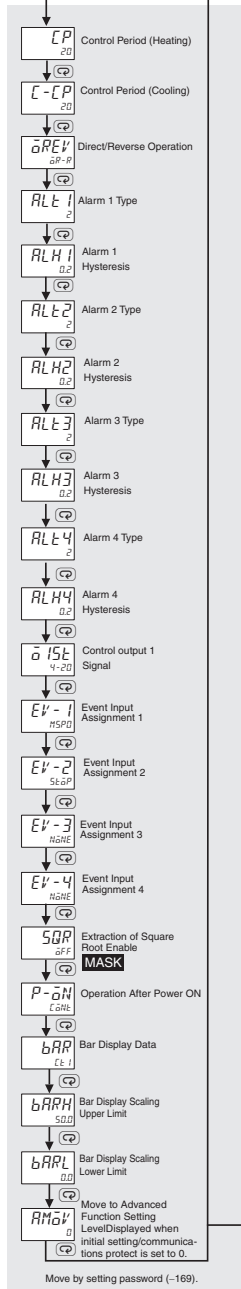

Error Displays (Troubleshooting)

When an error occurs, the No. 1 display or No. 2 display shows the error code.
Take necessary measure according to the error code, referring the following table.

Display	Name	Meaning	Action	Operation
5.ERR	Input error	<p>The input value exceeded the control range.* The input type is not set correctly. The sensor is disconnected or short-circuited. The sensor is not wired correctly. The sensor is not wired.</p> <p>* Control Range Temperature resistance thermometer or thermocouple input: SP Lower Limit - 20°C to SP Upper Limit + 20°C (SP Lower Limit - 40°F to SP Upper Limit + 40°F) ESIB input: Same as specified input range. Analog input: Scaling range -5% to 105%</p>	<p>Check the wiring for input to be sure it is wired correctly, not broken, and not shorted. Also check the input type. If there are no problems in the wiring or input type settings, cycle the power supply. If the display remains the same, replace the Digital Temperature Controller. If the display is restored to normal, then the probable cause is external noise affecting the control system. Check for external noise.</p> <p>Note: For a temperature resistance thermometer, the input is considered disconnected if the A, B, or B line is broken.</p>	<p>After the error occurs and it is displayed, the alarm output will operate as if the upper limit was exceeded. If an input error is assigned to a control output or auxiliary output, the output will turn ON when the input error occurs. The error message will appear in the display for the PV.</p> <p>Note: 1. The heating and cooling control outputs will turn OFF. 2. When the manual MV, MV at stop, or MV at error is set, the control output is determined by the set value.</p>
cccc	Display range exceeded	Below -1,999	-	<p>Control continues and operation is normal. The value will appear in the display for the PV. Refer to the E5□D Digital Temperature Controllers User's Manual (Cat. No. H224) for information on the controllable range.</p>
cccc		Above 9,999		
E333	A/D converter error	There is an error in the internal circuits.	<p>After checking the input error, turn the power OFF then back ON again. If the display remains the same, the controller must be repaired. If the display is restored to normal, then a probable cause can be external noise affecting the control system. Check for external noise.</p>	<p>The control outputs and auxiliary outputs turn OFF. (A linear voltage output will be approx. 0 mV.)</p>
E111	Memory error	There is an error in the internal memory operation.	<p>First, cycle the power supply. If the display remains the same, the controller must be repaired. If the display is restored to normal, then a probable cause can be external noise affecting the control system. Check for external noise.</p>	<p>The control outputs and auxiliary outputs turn OFF. (A linear voltage output will be approx. 0 mV.)</p>
FFFF	Overcurrent	This error is displayed when the peak current exceeds 55.0 A.	-	<p>Control continues and operation is normal. The error message will appear for the following displays. Heater Current Value 1 Monitor Leakage Current Value 1 Monitor</p>
LE1 LER1	HB or HS alarm	If there is a HB or HS alarm, the No. 1 display will flash in the relevant setting level.	-	<p>The No. 1 display for the following parameter flashes in Operation Level or Adjustment Level. Heater Current Value 1 Monitor Leakage Current Value 1 Monitor However, control continues and operation is normal.</p>
----	Ambient temperature out of monitor range	Ambient temperature exceeded the following display range. Temperature unit = °C: -30 to 75°C Temperature unit = °F: 10 to 171°F	<p>Make sure that the ambient temperature of the Controller is within the rated range. The following factors may be present. Check them.</p> <ul style="list-style-type: none"> The Controller is subjected to heat radiated from heating equipment. The Controller is subjected to direct sunlight. The Controller is subjected to icing or condensation. 	<p>Control continues and operation is normal.</p>





Safety Precautions

Be sure to read the precautions for all E5CD-800/E5ED-800 models in the website at: <http://www.ia.omron.com/>.

Warning Indications

 CAUTION	Indicates a potentially hazardous situation which, if not avoided, may result in minor or moderate injury or in property damage.
Precautions for Safe Use	Supplementary comments on what to do or avoid doing, to use the product safely.
Precautions for Correct Use	Supplementary comments on what to do or avoid doing, to prevent failure to operate, malfunction or undesirable effect on product performance.

Meaning of Product Safety Symbols

	Used for general CAUTION, WARNING, or DANGER precautions for which there is no specified symbol. (This symbol is also used as the alerting symbol, but shall not be used in this meaning on the product.)
	Used to warn of the risk of electric shock under specific conditions.
	Used for general prohibitions for which there is no specific symbol.
	Used to indicate prohibition when there is a risk of minor injury from electrical shock or other source if the product is disassembled.
	Used for general mandatory action precautions for which there is no specified symbol.

CAUTION

Minor injury due to electric shock may occasionally occur.
Do not touch the terminals while power is being supplied.



Electric shock, fire, or malfunction may occasionally occur.
Do not allow metal objects, conductors, debris (such as cuttings) from installation work, moisture, or other foreign matter to enter the Digital Temperature Controller, the Setup Tool ports, or between the pins on the connectors on the Setup Tool cable.
Attach the cover to the front-panel Setup Tool port whenever you are not using it to prevent foreign objects from entering the port.



Minor injury from explosion may occasionally occur.
Do not use the product where subject to flammable or explosive gas.



Minor electric shock or fire may occasionally occur.
Do not use a Digital Temperature Controller or cable that is damaged.



Minor electric shock, fire, or malfunction may occasionally occur.
Never disassemble, modify, or repair the product or touch any of the internal parts.



If the output relays are used past their life expectancy, contact fusing or burning may occasionally occur. Always consider the application conditions and use the output relays within their rated load and electrical life expectancy. The life expectancy of output relays varies considerably with the output load and switching conditions.



Loose screws may occasionally result in fire. Tighten the terminal screws to the specified torque of 0.43 to 0.58 N·m.



Set the parameters of the product so that they are suitable for the system being controlled. If they are not suitable, unexpected operation may occasionally result in property damage or accidents.



A malfunction in the Digital Temperature Controller may occasionally make control operations impossible or prevent alarm outputs, resulting in property damage. To maintain safety in the event of malfunction of the Digital Temperature Controller, take appropriate safety measures, such as installing a monitoring device on a separate line.



Safety Standard

CAUTION - Risk of Fire and Electric Shock

- This product is UL listed as Open Type Process Control Equipment. It must be mounted in an enclosure that does not allow fire to escape externally.
- More than one disconnect switch may be required to de-energize the equipment before servicing.
- Signal inputs are SELV, limited energy.^{*1}
- Caution: To reduce the risk of fire or electric shock, do not interconnect the outputs of different Class 2 circuits.^{*2}



*1. An SELV (separated extra-low voltage) system is one with a power supply that has double or reinforced insulation between the primary and the secondary circuits and has an output voltage of 30 V r.m.s. max. and 42.4 V peak max. or 60 VDC max.

*2. A class 2 circuit is one tested and certified by UL as having the current and voltage of the secondary output restricted to specific levels.

Precautions for Safe Use

Be sure to observe the following precautions to prevent operation failure, malfunction, or adverse affects on the performance and functions of the product. Not doing so may occasionally result in unexpected events. Do not handle the Digital Temperature Controller in ways that exceed the ratings.

- The product is designed for indoor use only. Do not use or store the product outdoors or in any of the following places.
 - Places directly subject to heat radiated from heating equipment.
 - Places subject to splashing liquid or oil atmosphere.
 - Places subject to direct sunlight.
 - Places subject to dust or corrosive gas (in particular, sulfide gas and ammonia gas).
 - Places subject to intense temperature change.
 - Places subject to icing and condensation.
 - Places subject to vibration and large shocks.
- Use and store the Digital Temperature Controller within the rated ambient temperature and humidity. Gang-mounting two or more Digital Temperature Controllers, or mounting Digital Temperature Controllers above each other may cause heat to build up inside the Digital Temperature Controllers, which will shorten their service life. In such a case, use forced cooling by fans or other means of air ventilation to cool down the Digital Temperature Controllers.
- To allow heat to escape, do not block the area around the Digital Temperature Controller. Do not block the ventilation holes on the Digital Temperature Controller.
- Always check the terminal names and polarity and be sure to wire properly.
- To connect bare wires, use copper stranded or solid wires.

Recommended Wires

Model	Recommended wires	Stripping length
E5CD-800 or E5ED-800	AWG24 to AWG18 (0.21 to 0.82 mm ²)	6 to 8 mm
E5□D-B-800 (Push-In Plus Terminal Blocks)	0.25 to 1.5 mm ² (equivalent to AWG24 to AWG16)	Ferrules not used: 8 mm

Use the specified size of crimped terminals to wire the E5CD-800 or E5ED-800.

Crimp Terminal Sizes

Model	Crimp terminal size
E5CD-800 or E5ED-800	M3, Width: 5.8 mm max.

For the E5□D-B-800 (Push-In Plus model), connect only one wire to each terminal.

For the E5CD/E5ED (Screw model), up to two wires of same size and type, or two crimp terminals, can be inserted into a single terminal.

- Do not wire the terminals that are not used.
- To avoid inductive noise, keep the wiring for the Digital Temperature Controller's terminal block away from power cables that carry high voltages or large currents. Also, do not wire power lines together with or parallel to Digital Temperature Controller wiring. Using shielded cables and using separate conduits or ducts is recommended. Attach a surge suppressor or noise filter to peripheral devices that generate noise (in particular, motors, transformers, solenoids, magnetic coils or other equipment that have an inductance component). When a noise filter is used at the power supply, first check the voltage or current, and attach the noise filter as close as possible to the Digital Temperature Controller. Allow as much space as possible between the Digital Temperature Controller and devices that generate powerful high frequencies (high-frequency welders, high-frequency sewing machines, etc.) or surge.
- Use the Digital Temperature Controller within the rated load and power supply.

- Make sure that the rated voltage is attained within 2 seconds of turning ON the power using a switch or relay contact. If the voltage is applied gradually, the power may not be reset or output malfunctions may occur.
- Make sure that the Digital Temperature Controller has 30 minutes or more to warm up after turning ON the power before starting actual control operations to ensure the correct temperature display.
- When using adaptive control, turn ON power for the load (e.g., heater) at the same time as or before supplying power to the Digital Temperature Controller. If power is turned ON for the Digital Temperature Controller before turning ON power for the load, tuning will not be performed properly and optimum control will not be achieved.
- During tuning,* ensure that the power for the load (e.g., heater) is ON. If the power supply to the load (e.g., heater) is not turned ON during tuning, tuning results will not be calculated correctly and it will not be possible to achieve optimum control.

* "Tuning" refers to the following functions: AT, adaptive control, automatic filter adjustment, and water-cooling output adjustment.
- A switch or circuit breaker must be provided close to Digital Temperature Controller. The switch or circuit breaker must be within easy reach of the operator, and must be marked as a disconnecting means for Digital Temperature Controller.
- Wipe off any dirt from the Digital Temperature Controller with a soft dry cloth. Never use thinners, benzene, alcohol, or any cleaners that contain these or other organic solvents. Deformation or discoloration may occur.
- Design the system (e.g., control panel) considering the 2 seconds of delay in setting the Digital Temperature Controller's output after the power supply is turned ON.
- The output will turn OFF when you move to the Initial Setting Level. Take this into consideration when performing control.
- The number of non-volatile memory write operations is limited. Therefore, use RAM write mode when frequently overwriting data, e.g., through communications.
- Always touch a grounded piece of metal before touching the Digital Temperature Controller to discharge static electricity from your body.
- Use suitable tools when taking the Digital Temperature Controller apart for disposal. Sharp parts inside the Digital Temperature Controller may cause injury.
- Install the DIN Track vertically to the ground.
- Observe the following precautions when drawing out the body of the Digital Temperature Controller.
 - Follow the procedure given in *Drawing Out the Interior Body of the Digital Temperature Controller to Replace It* on page 46.
 - Turn OFF the power supply before you start and never touch nor apply shock to the terminals or electric components. When you insert the interior body of the Digital Temperature Controller, do not allow the electronic components to touch the rear case.
 - When you insert the interior body into the rear case, confirm that the hooks on the top and bottom are securely engaged with the case.
 - If the terminals are corroded, replace the rear case as well.
- For the power supply voltage input, use a commercial power supply with an AC input. Do not use the output from an inverter as the power supply. Depending on the output characteristics of the inverter, temperature increases in the product may cause smoke or fire damage even if the product has a specified output frequency of 50/60 Hz.
- Do not continue to use the Digital Temperature Controller if the front surface peels.
- Do not exceed the communications distance that is given in the specifications and use the specified communications cable. Refer to the *E5□D Digital Temperature Controllers User's Manual* (Cat. No. H224) for information on the communications distances and cables for the E5□D-800.

25. Observe the following precautions when you wire the E5□D-B.
- Always follow the *E5□D Digital Temperature Controllers User's Manual* (Cat. No. H224).
 - Do not wire anything to the release holes.
 - Do not tilt or twist a flat-blade screwdriver while it is inserted into a release hole on the terminal block. The terminal block may be damaged.
 - Insert a flat-blade screwdriver into the release holes at an angle. The terminal block may be damaged if you insert the screwdriver straight in.
 - Do not allow the flat-blade screwdriver to fall out while it is inserted into a release hole.
 - Do not bend a wire past its natural bending radius or pull on it with excessive force. Doing so may cause the wire to break.
 - Do not use crossover wiring except for the input power supply and communications.

Precautions for Correct Use

Service Life

1. Use the Digital Temperature Controller within the following temperature and humidity ranges:
Temperature: -10 to 55°C (with no icing or condensation),
Humidity: 25% to 85%
If the Digital Temperature Controller is installed inside a control board, the ambient temperature must be kept to under 55°C, including the temperature around the Digital Temperature Controller.
2. The service life of electronic devices like Digital Temperature Controllers is determined not only by the number of times the relay is switched but also by the service life of internal electronic components. Component service life is affected by the ambient temperature: the higher the temperature, the shorter the service life and, the lower the temperature, the longer the service life. Therefore, the service life can be extended by lowering the temperature of the Digital Temperature Controller.
3. When two or more Digital Temperature Controllers are mounted horizontally close to each other or vertically next to one another, the internal temperature will increase due to heat radiated by the Digital Temperature Controllers and the service life will decrease. In such a case, use forced cooling by fans or other means of air ventilation to cool down the Digital Temperature Controllers. When providing forced cooling, however, be careful not to cool down the terminals sections alone to avoid measurement errors.

Ensuring Measurement Accuracy

1. When extending or connecting the thermocouple lead wire, be sure to use compensating wires that match the thermocouple types.
2. When extending or connecting the lead wire of the platinum resistance thermometer, be sure to use wires that have low resistance and keep the resistance of the three lead wires the same.
3. Mount the Digital Temperature Controller so that it is horizontally level.
4. If the measurement accuracy is low, check to see if input shift has been set correctly.

Resistance to Water

The degree of protection is as shown below. Sections without any specification on their degree of protection or those with IP□0 are not waterproof.

Front panel: IP66

Rear case: IP20, Terminal section: IP00

When waterproofing is required, insert the Waterproof Packing on the backside of the front panel.

The degree of protection when the Waterproof Packing is used is IP66. To maintain an IP66 degree of protection, the Waterproof Packing must be periodically replaced because they may deteriorate, shrink, or harden depending on the operating environment.

The replacement period will vary with the operating environment. Check the required period in the actual application. Use 3 years or sooner as a guideline. If the Waterproof Packing and Port Cover are not periodically replaced, waterproof performance may not be maintained.

If a waterproof structure is not required, then the Waterproof Packing does not need to be installed.

Precautions during Operation

1. It takes approximately two seconds for the outputs to turn ON from after the power supply is turned ON. Design the system (e.g., control panel) to allow for this delay.
2. Make sure that the Digital Temperature Controller has 30 minutes or more to warm up after turning ON the power before starting actual control operations to ensure the correct temperature display.
3. Avoid using the Digital Temperature Controller in places near a radio, television set, or wireless installing. The Digital Temperature Controller may cause radio disturbance for these devices.

Mounting

E5CD-800/E5ED-B-800

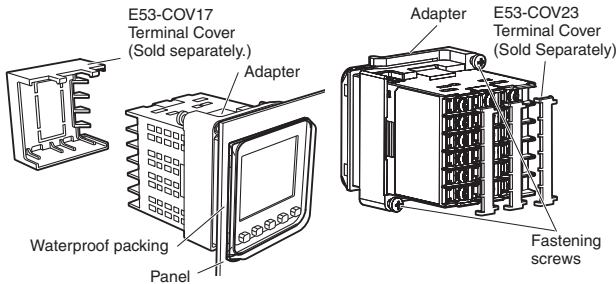

Mounting to the Panel (E5ED-800/E5ED-B-800)

1. For waterproof mounting, waterproof packing must be installed on the Digital Temperature Controller. Waterproofing is not possible when group mounting several Digital Temperature Controllers.
2. Insert the E5CD-800/E5ED-B-800 into the mounting hole in the panel.
3. Push the Adapter from the terminals up to the panel, and temporarily fasten the E5CD-800/E5ED-B-800.
4. Tighten the two fastening screws on the Adapter. Alternately tighten the two screws little by little to maintain a balance. Tighten the screws to a torque of 0.29 to 0.39 N·m.

Mounting the Terminal Cover (E5ED-800 only)

There are two models of Terminal Covers that you can use with the E5CD-800.

Slightly bend the E53-COV23 Terminal Cover to attach it to the terminal block as shown in the following diagram. The Terminal Cover cannot be attached in the opposite direction. Or, you can use the E53-COV17 Terminal Cover. Make sure that the "UP" mark is facing up, and then attach the E53-COV17 Terminal Cover to the holes on the top and bottom of the Digital Temperature Controller.

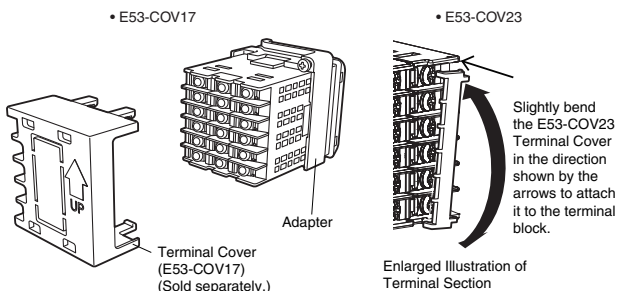

E5ED-800/E5ED-B-800

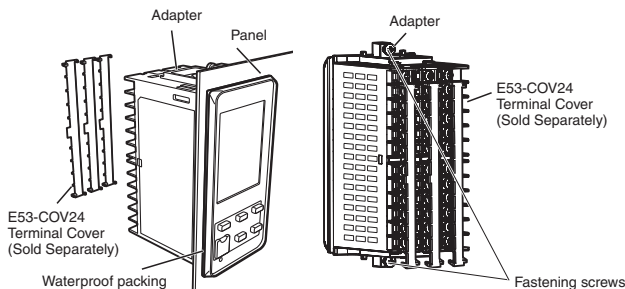

Mounting to the Panel (E5ED-800/E5ED-B-800)

1. For waterproof mounting, waterproof packing must be installed on the Digital Temperature Controller. Waterproofing is not possible when group mounting several Digital Temperature Controllers.
2. Insert the E5ED-800/E5ED-B-800 into the mounting hole in the panel.
3. Push the Adapter from the terminals up to the panel, and temporarily fasten the E5ED-800/E5ED-B-800.
4. Tighten the two fastening screws on the Adapter. Alternately tighten the two screws little by little to maintain a balance. Tighten the screws to a torque of 0.29 to 0.39 N·m.

Mounting the Terminal Cover (E5ED-800 only)

Slightly bend the E53-COV24 Terminal Cover to attach it to the terminal block as shown in the following diagram. The Terminal Cover cannot be attached in the opposite direction.

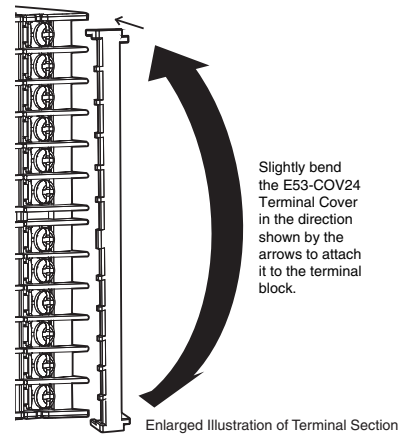

Drawing Out the Interior Body of the Digital Temperature Controller to Replace It

You can use the Draw-out Jig to remove the interior body of the Digital Temperature Controller from the case to perform maintenance without removing the terminal leads. Use the Y92F-58 Draw-out Jig for the E5CD-800 and the Y92F-59 Draw-out Jig for the E5ED-800. Check the specifications of the case and Digital Temperature Controller before removing the interior body from the case. (Drawout is not possible on the E5□D-B-800.)

1. Draw out the interior body from the rear case.

1. Align the arms on the Draw-out Jig with the top of the front panel on the Digital Temperature Controller and position it vertically. (The Y92F-58 is shown in the figure.)

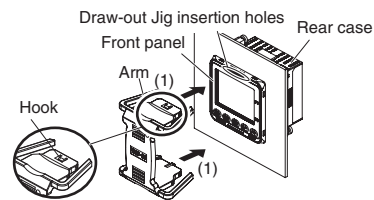

2. Align the hooks on the Draw-out Jig with the Draw-out Jig insertion holes on the Digital Temperature Controller and slowly insert the Draw-out Jig into the Draw-out Jig insertion holes laterally until it clicks into place. (If you attempt to draw out the interior body of the Digital Temperature Controller when only one hook is engaged, the Digital Temperature Controller may be damaged.) (The Y92F-58 is shown in the figure.)

3. Pull out the Draw-out Jig together with the front panel. Do not pull with excessive force. Slowly pull out the Digital Temperature Controller laterally. (If you pull the interior body out at an angle, the Digital Temperature Controller may be damaged.)

Draw-out Jig insertion holes

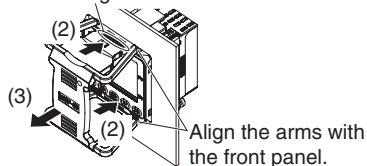

4. After the interior body is free from the rear case, support the interior body with one hand and pull it out slowly in a horizontal direction.

2. Prepare the new interior body.

1. Place the Digital Temperature Controller flat on a table and slowly insert the Draw-out Jig into the Draw-out Jig insertion holes laterally until it clicks into place. (There is a hole at both the top and bottom.) (The E5CD-800 is shown in the figure.)
2. Place the Digital Temperature Controller on a table facing upward.
3. Hold the rear case with your hand and slowly draw out the interior body in a vertical direction. If you draw out the interior body horizontally while holding the Digital Temperature Controller in your hand, the interior body will fall and may be damaged.

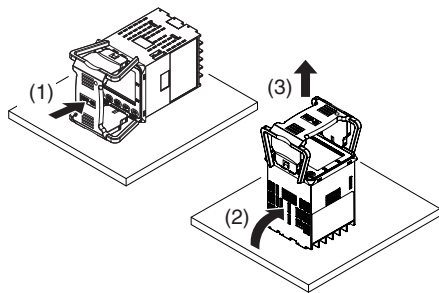

3. Insert the new interior body into the rear case.

1. When inserting the interior body back into the rear case, mount the sealing rubber in the position shown below, make sure the PCBs are parallel to each other, and press the interior body toward the rear case and into position, making sure that the sealing rubber does not move.

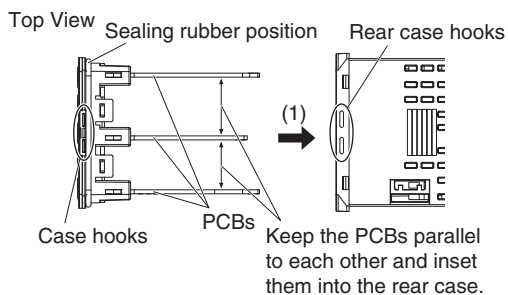

2. When you press the Digital Temperature Controller into position, press down on the rear case hooks so that the case hooks securely lock in place. (There are rear case hooks at both the top and bottom of the rear case.) If the Digital Temperature Controller is not correctly mounted into the rear case, the rear case may not be waterproof. When inserting the Digital Temperature Controller, do not allow the electronic components to touch the rear case. (The E5CD-800 is shown in the figure.)

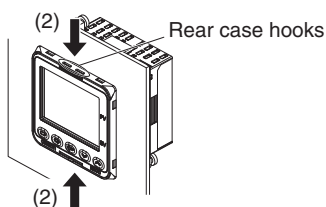

Removing the draw-out jig when only one hook is caught in the draw-out jig insertion hole

1. Pull the Draw-out Jig slowly in the direction shown in the figure. (This step is the same even if the other hook is caught.)
2. Confirm that the Draw-out Jig is free of the Draw-out Jig insertion hole.
3. If the interior body separates from the rear case, slowly press the interior body into the rear case in a horizontal direction. (The E5CD-800 is shown in the figure.) If you do not follow the procedures above, the Digital Temperature Controller may be damaged.

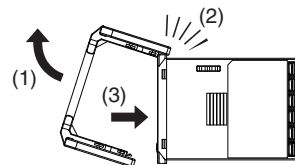

Precautions when Wiring

- Separate input leads and power lines in order to prevent external noise.
- Use crimp terminals when wiring the screw terminals.
- Use the suitable wiring material and crimp tools for crimp terminals.
- Tighten the terminal screws to a torque of 0.43 to 0.58 N·m.

E5CD-800/E5ED-800 (Screw Terminal Blocks)

Wires

Use the wire specifications given in the following table.

Model	Recommended wires	Stripping length
E5CD-800 or E5ED-800	AWG24 to AWG18 (0.205 to 0.823 mm ²)	6 to 8 mm (when crimp terminals are not used)

- Strip the wires on which crimp terminals will be used to the length recommended by the crimp terminal manufacturer.
- Use shielded twisted-pair cables for signal lines to prevent the influence of noise.

Crimp Terminals

For the E5CD-800 or E5ED-800, use the following types of crimp terminals for M3 screws.

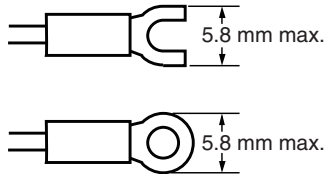

Although you can connect two crimp terminals with insulation sleeves to one terminal, you cannot do so if the diameter of the insulation sleeves is too large.

E5□D-B-800 (Push-In Plus terminal block types)

1. Connecting Wires to Push-In Plus Terminal Block

Part Names of the Terminal Block

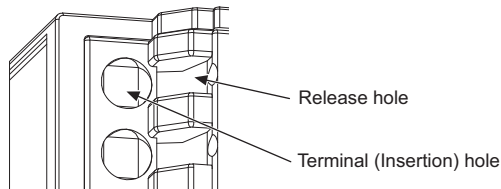

Connecting Wires with Ferrules and Solid Wires

Insert the solid wire or ferrule straight into the terminal block until the end strikes the terminal block.

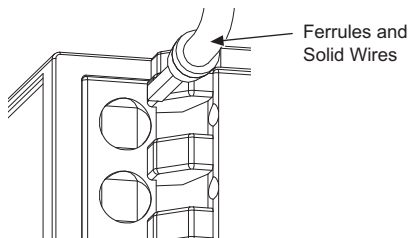

If a wire is difficult to connect because it is too thin, use a flat-blade screwdriver in the same way as when connecting stranded wire.

Connecting Stranded Wires

Use the following procedure to connect the wires to the terminal block.

1. Hold a flat-blade screwdriver at an angle and insert it into the release hole. The angle should be between 10° and 15°. If the flat-blade screwdriver is inserted correctly, you will feel the spring in the release hole.
2. With the screwdriver still inserted into the release hole, insert the wire into the terminal hole until it strikes the terminal block.
3. Remove the flat-blade screwdriver from the release hole.

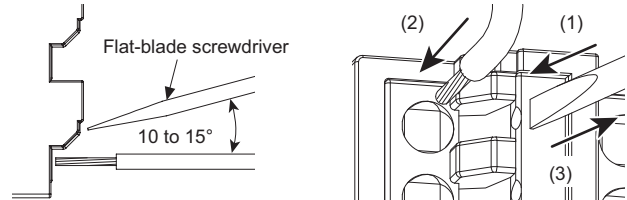

Checking Connections

- After the insertion, pull gently on the wire to make sure that it will not come off and the wire is securely fastened to the terminal block.
- If you use a ferrule with a conductor length of 10 mm, part of the conductor may be visible after the ferrule is inserted into the terminal block, but the product insulation distance will still be satisfied.

2. Removing Wires from Push-In Plus Terminal Block

Use the following procedure to remove wires from the terminal block. The same method is used to remove stranded wires, solid wires, and ferrules.

1. Hold a flat-blade screwdriver at an angle and insert it into the release hole.
2. With the screwdriver still inserted into the release hole, remove the wire from the terminal insertion hole.
3. Remove the flat-blade screwdriver from the release hole.

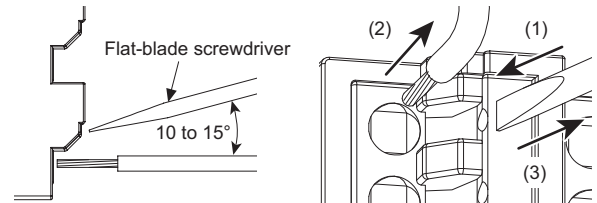

3. Recommended Ferrules and Crimp Tools Recommended wires (Stranded wire/Solid wire)

Recommended wire	Stripping length (Ferrules not used)
0.25-1.5 mm ² /AWG24-16	8 mm

Recommended ferrules

Applicable wire		Ferrule Conductor length (mm)	Wire Stripping length (mm) (Ferrules used)	Recommended ferrules		
(mm ²)	(AWG)			Phoenix Contact product	Weidmuller product	Wago product
0.25	24	8	10	AI 0,25-8	H0.25/12	216-301
		10	12	AI 0,25-10	---	---
0.34	22	8	10	AI 0,34-8	H0.34/12	216-302
		10	12	AI 0,34-10	---	---
0.5	20	8	10	AI 0,5-8	H0.5/14	216-201
		10	12	AI 0,5-10	H0.5/16	216-241
0.75	18	8	10	AI 0,75-8	H0.75/14	216-202
		10	12	AI 0,75-10	H0.75/16	216-242
1/1.25	18/17	8	10	AI 1-8	H1.0/14	216-203
		10	12	AI 1-10	H1.0/16	216-243
1.25/1.5	17/16	8	10	AI 1,5-8	H1.5/14	216-204
		10	12	AI 1,5-10	H1.5/16	216-244
Recommended crimp tool				CRIMPFOX6 CRIMPFOX6T-F CRIMPFOX10S	PZ6 roto	Variocrimp4

*1. Make sure that the outer diameter of the wire coating is smaller than the inner diameter of the insulation sleeve of the recommended ferrule.

*2. Make sure that the ferrule processing dimensions conform to the following figures.

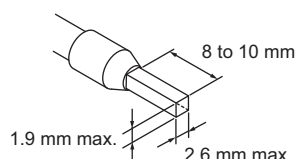

Three-year Guarantee

Period of Guarantee

The guarantee period of the Unit is three years starting from the date the Unit is shipped from the factory.

Scope of Guarantee

The Unit is guaranteed under the following operating conditions.

1. Average Operating Temperature (see note): -10°C to 50°C
2. Mounting Method: Standard mounting (Mounted to panel or DIN Track.)

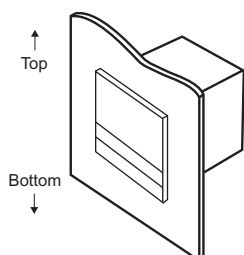

Example: Mounted to Panel

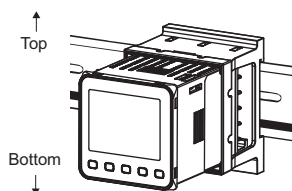

Example: Mounted to DIN Track

Note: Average Operating Temperature

Refer to the process temperature of the Unit mounted to a control panel and connected to peripheral devices on condition that the Unit is in stable operation, sensor input type K is selected for the Unit, the positive and negative thermocouple input terminals of the Unit are short-circuited, and the ambient temperature is stable.

Recommended Flat-blade Screwdriver

Use a flat-blade screwdriver to connect and remove wires.

Use the following flat-blade screwdriver.

The following table shows manufacturers and models as of 2015/Dec

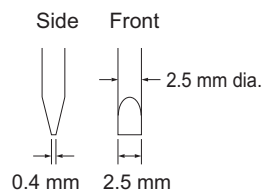

Model	Manufacturer
ESD 0,40X2,5	Wera
SZS 0,4X2,5 SZF 0-0,4X2,5 *	Phoenix Contact
0.4X2.5X75 302	Wiha
AEF.2,5X75	Facom
210-719	Wago
SDI 0.4X2.5X75	Weidmuller

* OMRON's exclusive purchase model XW4Z-00B is available to order as SZF 0-0,4X2,5 (manufactured by Phoenix Contact).