

DIN W48×H48mm 8 Pin Plug Counter

■ Features

- Upgraded counting speed: 1cps / 30cps / 2kcps / 5kcps
- Selectable voltage input (PNP) method or no-voltage input (NPN) method
- Decimal point setting (fixed decimal point of display)
- Wide range of power supply
: 100-240VAC 50/60Hz, 24VAC 50/60Hz, 24-48VDC universal
- Memory protection for 10 years (using non-volatile semiconductor)
- Selectable Up/Down for counting value
- Built-in Microprocessor



⚠ Please read "Safety Considerations" in the instruction manual before using.



■ Ordering Information

FS 4 - 1P 4

Power supply	2	24VAC 50/60Hz, 24-48VDC
	4	100-240VAC 50/60Hz
Output	1P	1-stage setting
	I	Indicator
Display digit	4	9999 (4-digit)
	5	99999 (5-digit)
Item	FS	8-pin plug counter

※8-pin socket (PG-08, PS-08(N)) is sold separately.

■ Specifications

Model	1-stage setting Indicator	FS4-1P2	FS4-1P4	—
Display digit	Indicator	4-digit	—	FS5-I4
Character size (W×H)		3.8×7.6mm		4×8mm
Power supply		24VAC~ 50/60Hz, 24-48VDC=	100-240VAC~ 50/60Hz	
Permissible voltage range		90 to 110% of rated voltage		
Power consumption		Max. 3.5VA (24VAC~ 50/60Hz), Max. 2.3W (24-48VDC=)	Max. 4.6VA (100-240VAC~ 50/60Hz)	Max. 3.8VA (100-240VAC~ 50/60Hz)
Max. counting speed for COUNT IN		Selectable 1cps/30cps/2kcps/5kcps (DIP switch)		
Return time		Max. 500ms		
Min. signal width		RESET: approx. 20ms		
Input method		Selectable voltage input (PNP) method or no-voltage input (NPN) method [Voltage input (PNP) method]-input impedance: max. 10.8kΩ, [H]: 5-30VDC=, [L]: 0-2VDC [No-voltage input (NPN) method]-short-circuit impedance: max. 470Ω, short-circuit residual voltage: max. 1VDC, open-circuit impedance: min. 100kΩ		
One-shot output time		0.05 to 5 sec		
Control output	Contact	Instantaneous SPST (1a)		
	Capacity	250VAC~ 3A, 30VDC= 3A resistive load		
Relay life cycle	Mechanical	Min. 5,000,000 operations		
	Electrical	Min. 100,000 operations (250VAC 3A resistive load)		
Insulation resistance		Over 100MΩ (at 500VDC megger)		
External power supply		Max. 12VDC= ±10% 50mA		
Memory retention		Approx. 10 years (non-volatile memory)		
Dielectric strength		2,000VAC 50/60Hz for 1 min (between all terminals and case)		
Noise immunity	AC voltage	±2kV the square wave noise (pulse width 1μs) by noise simulator		
	AC/DC voltage	±500V the square wave noise (pulse width 1μs) by noise simulator		
Vibration	Mechanical	0.75mm amplitude at frequency 10 to 55Hz (for 1 min) in each X, Y, Z direction for 1 hour		
	Malfunction	0.5mm amplitude at frequency 10 to 55Hz (for 1 min) in each X, Y, Z direction for 10 min		
Shock	Mechanical	300m/s ² (approx. 30G) in each X, Y, Z direction for 3 times		
	Malfunction	100m/s ² (approx. 10G) in each X, Y, Z direction for 3 times		
Environment	Ambient temp.	-10 to 55°C, storage: -25 to 65°C		
	Ambient humi.	35 to 85%RH, storage: 35 to 85%RH		
Protection structure		IP20 (front part, IEC standard)		
Approval		CE RoHS US		
Weight ^{※1}		Approx. 130g (approx. 90g)		Approx. 120g (approx. 80g)

※1: The weight includes packaging. The weight in parenthesis is for unit only.

※Environment resistance is rated at no freezing or condensation.

SENSORS

CONTROLLERS

MOTION DEVICES

SOFTWARE

(J)
Temperature
Controllers

(K)
SSRs

(L)
Power
Controllers

(M)
Counters

(N)
Timers

(O)
Digital
Panel Meters

(P)
Indicators

(Q)
Converters

(R)
Digital
Display Units

(S)
Sensor
Controllers

(T)
Switching
Mode Power
Supplies

(U)
Recorders

(V)
HMIs

(W)
Panel PC

(X)
Field Network
Devices



FS Series

Connections

● FS4-1P4

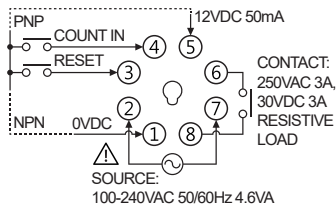

● FS4-1P2

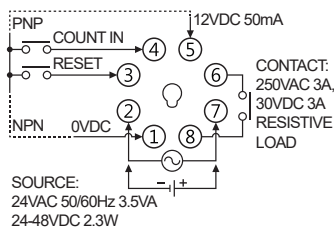

● FS5-I4

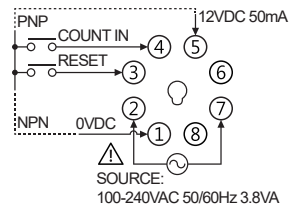

Input Connections

○ Voltage input (PNP)

● Solid-state input (standard sensor: PNP output type sensor)

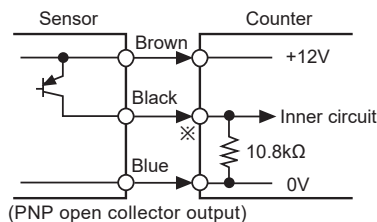
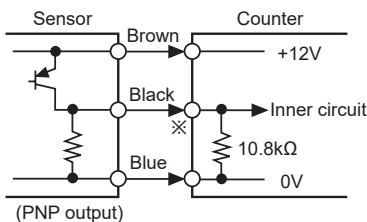

● Contact input

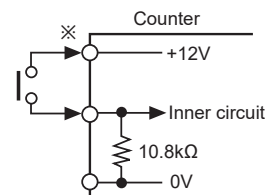

※ Counting speed
: Set as 1 or 30cps

※COUNT IN, RESET input part

○ No-voltage input (NPN)

● Solid-state input (standard sensor: NPN output type sensor)

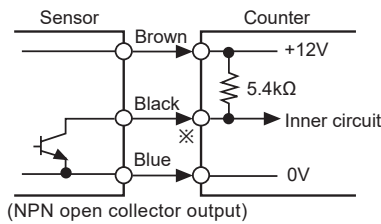
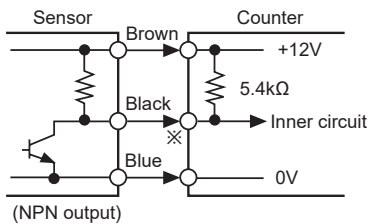

● Contact input

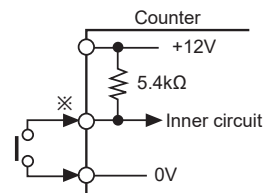

※ Counting speed
: Set as 1 or 30cps

※COUNT IN, RESET input part

○ Input & output connections

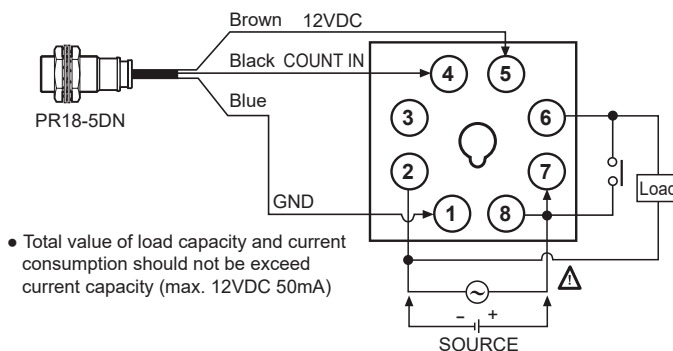

- Total value of load capacity and current consumption should not be exceed current capacity (max. 12VDC 50mA)

- Please select proper capacity of load not to exceed contact capacity. Contact capacity: max. 250VAC 3A Contact type: 1a

8 Pin Plug Type Counter

■ Dimensions

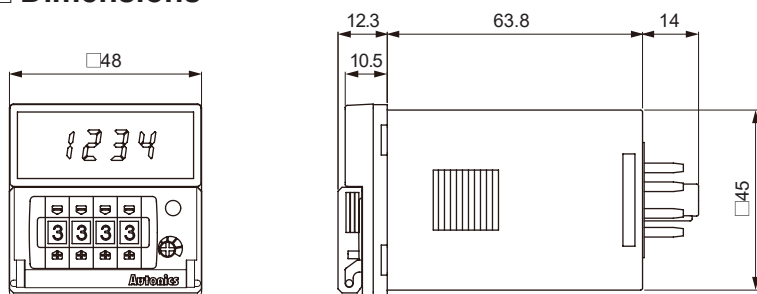

(unit: mm)

○ Bracket

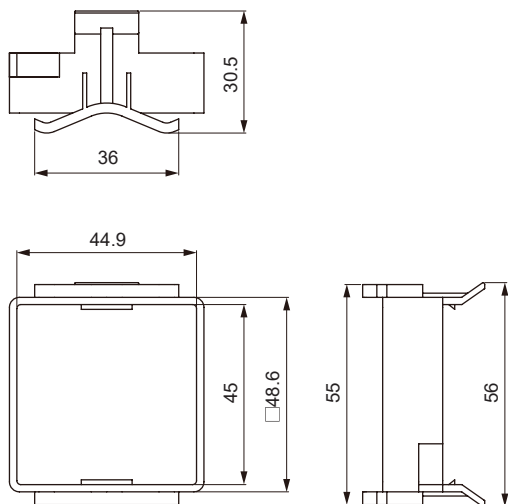

○ Panel cut-out

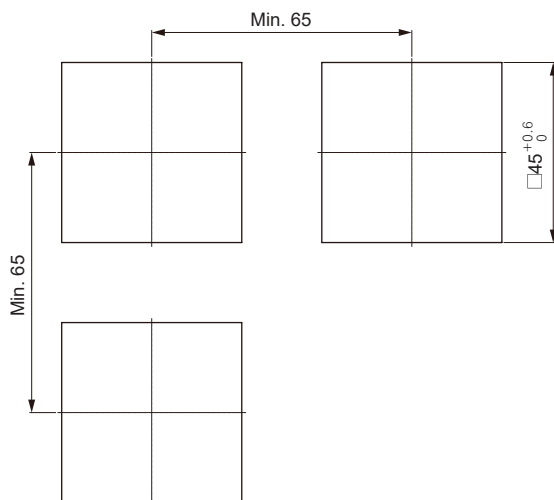

○ Socket (sold separately)

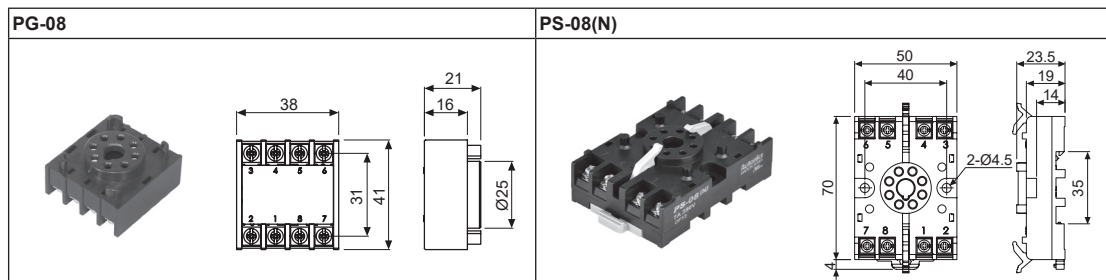

■ Error Display and Output Operation

Error Display	Error description	Troubleshooting
Err0	Setting value is 0.	Change the setting value anything but 0.

※When error occurs, the output turns OFF.

※Indicator model does not have error display function.

SENSORS
CONTROLLERS
MOTION DEVICES
SOFTWARE

(J) Temperature Controllers
(K) SSRs
(L) Power Controllers
(M) Counters
(N) Timers
(O) Digital Panel Meters
(P) Indicators
(Q) Converters
(R) Digital Display Units
(S) Sensor Controllers
(T) Switching Mode Power Supplies
(U) Recorders
(V) HMIs
(W) Panel PC
(X) Field Network Devices

FS Series

■ DIP Switch Setting

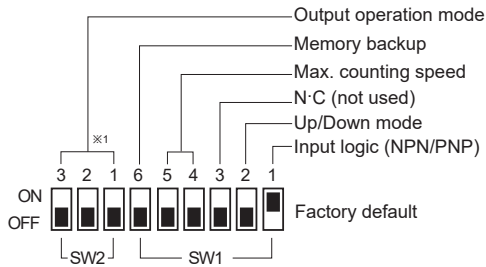
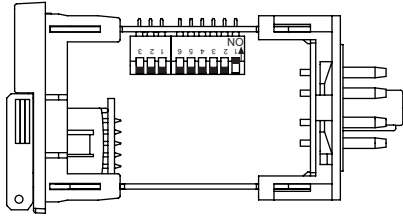

● Input logic (COUNT IN, RESET input)

SW1	Function
1	ON <input type="checkbox"/> OFF <input type="checkbox"/> NPN (no-voltage input)
	ON <input type="checkbox"/> OFF <input type="checkbox"/> PNP (voltage input)

● Up/Down mode

SW1	Function
2	ON <input type="checkbox"/> OFF <input type="checkbox"/> Down mode
	ON <input type="checkbox"/> OFF <input type="checkbox"/> Up mode

● Memory backup

SW1	Function
6	ON <input type="checkbox"/> OFF <input type="checkbox"/> No memory backup
	ON <input type="checkbox"/> OFF <input type="checkbox"/> Memory backup

※1: Indicator model (FS5-I4) does not have no. 1, 2, 3 DIP switch of SW2 for output operation mode setting.

● Max. counting speed

SW1	Function
ON <input type="checkbox"/> OFF <input type="checkbox"/> 5 4	1cps
ON <input type="checkbox"/> OFF <input type="checkbox"/> 5 4	30cps
ON <input type="checkbox"/> OFF <input type="checkbox"/> 5 4	2kcps
ON <input type="checkbox"/> OFF <input type="checkbox"/> 5 4	5kcps

※How to change settings

Power OFF → change settings → power ON → press **[RESET]** key or input signal (min. 20ms)

■ Dot for Decimal Point

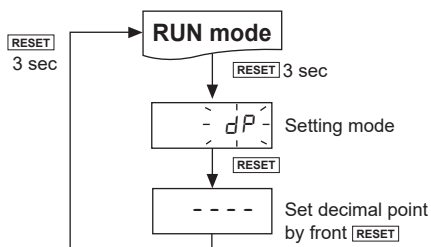

※In run mode, hold the **[RESET]** key for over 3 sec, and it enters setting mode [dP].

※In setting mode, hold the **[RESET]** key for over 3 sec, and it saves the setting and returns to RUN mode.

※If there is no **[RESET]** key input for 60 sec when entering setting mode, it returns to RUN mode.

■ Counting Operation for Indicator (FS5-I4)

● Up mode

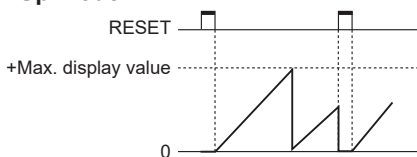

● Down mode

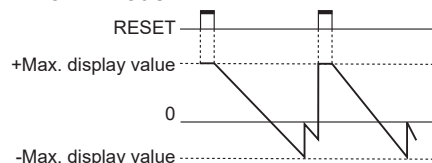

※- display is only for F, K, Q, S output operation mode and it cannot be set.

8 Pin Plug Type Counter

Output Operation Mode

■ ← One-shot output (0.05 to 5 sec)

□ ← Self-holding output

Output mode (SW2)	SW1 ON OFF 2 Up mode	SW1 ON OFF 2 Down mode	Operation
F ON OFF 3 2 1			After count-up, counting display value increases or decreases until reset signal input is applied and self-holding output is maintained.
N ON OFF 3 2 1			After count-up, counting display value and self-holding output are maintained until reset signal input is applied.
C ON OFF 3 2 1			When count-up, counting display value is reset and it counts simultaneously.
R ON OFF 3 2 1			After count-up, counting display value is reset after one-shot output time and it counts simultaneously.
K ON OFF 3 2 1			After count-up, counting display value increases or decreases until reset signal input is applied.
P ON OFF 3 2 1			After count-up, counting display value is maintained while output is ON. Counting value is internally reset and it counts simultaneously.
Q ON OFF 3 2 1			After count-up, counting display value increases or decreases during one-shot output time.
S ON OFF 3 2 1			Output maintains ON when counting display value is larger or equal than setting value.

※Set one-shot output time by front TIME volume switch.

Proper Usage

- Follow instructions in 'Proper Usage'. Otherwise, it may cause unexpected accidents.
- 24-48VDC, 24VAC power supply should be insulated and limited voltage/current or Class 2, SELV power supply device.
- Use the product, 0.1 sec after supplying power.
- When supplying or turning off the power, use a switch or etc. to avoid chattering.
- Install a power switch or circuit breaker in the easily accessible place for supplying or disconnecting the power.
- In case of contact input, set count speed to low speed mode (1cps or 30cps) to operate. If set to high speed mode (2kcps or 5kcps), counting error occurs due to chattering.
- Keep away from high voltage lines or power lines to prevent inductive noise. In case installing power line and input signal line closely, use line filter or varistor at power line and shielded wire at input signal line. Do not use near the equipment which generates strong magnetic force or high frequency noise.
- This product may be used in the following environments.
 - Indoors (in the environment condition rated in 'Specifications')
 - Altitude max. 2,000m
 - Pollution degree 2
 - Installation category II

SENSORS
CONTROLLERS
MOTION DEVICES
SOFTWARE
(J) Temperature Controllers
(K) SSRs
(L) Power Controllers
(M) Counters
(N) Timers
(O) Digital Panel Meters
(P) Indicators
(Q) Converters
(R) Digital Display Units
(S) Sensor Controllers
(T) Switching Mode Power Supplies
(U) Recorders
(V) HMIs
(W) Panel PC
(X) Field Network Devices