

FACTORY AUTOMATION

**e-Factory**

# MELSEC iQ-F Series iQ Platform-compatible PLC

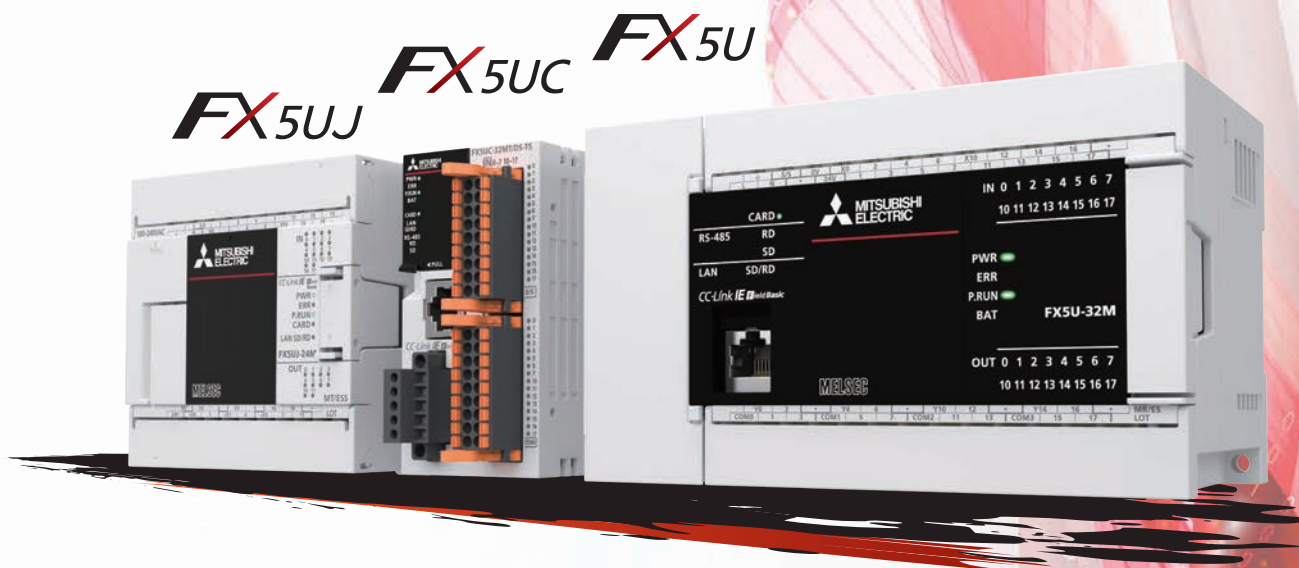

The next level of industry

**MELSEC iQ-F**  
series





## Automating the World

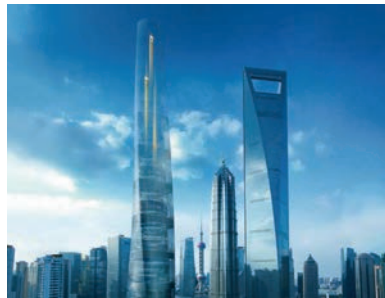

Our Factory Automation business is focused on "Automating the World" to make it a better, more sustainable environment supporting manufacturing and society, celebrating diversity and contributing towards an active and fulfilling role.

Mitsubishi Electric is involved in many areas including the following:

### **Energy and Electric Systems**

A wide range of power and electrical products from generators to large-scale displays.

### **Electronic Devices**

A wide portfolio of cutting-edge semiconductor devices for systems and products.

### **Home Appliance**

Dependable consumer products like air conditioners and home entertainment systems.

### **Information and Communication Systems**

Commercial and consumer-centric equipment, products and systems.

### **Industrial Automation Systems**

Maximizing productivity and efficiency with cutting-edge automation technology.



The Mitsubishi Electric Group is actively solving social issues, such as decarbonization and labor shortages, by providing production sites with energy-saving equipment and solutions that utilize automation systems, thereby helping towards a sustainable society.

# iQ Platform

## “Connect” Factory Automation with iQ Platform

“iQ Platform”, a solution that integrates and cooperates with controllers, HMI, engineering environments, and networks at the production site, Mitsubishi Electric has proposed along with “e-F@ctory” that information-links the high-level information system (manufacturing execution system (MES)) and production site, will integrate and optimize your system with advanced technology to reduce development, production and maintenance costs.

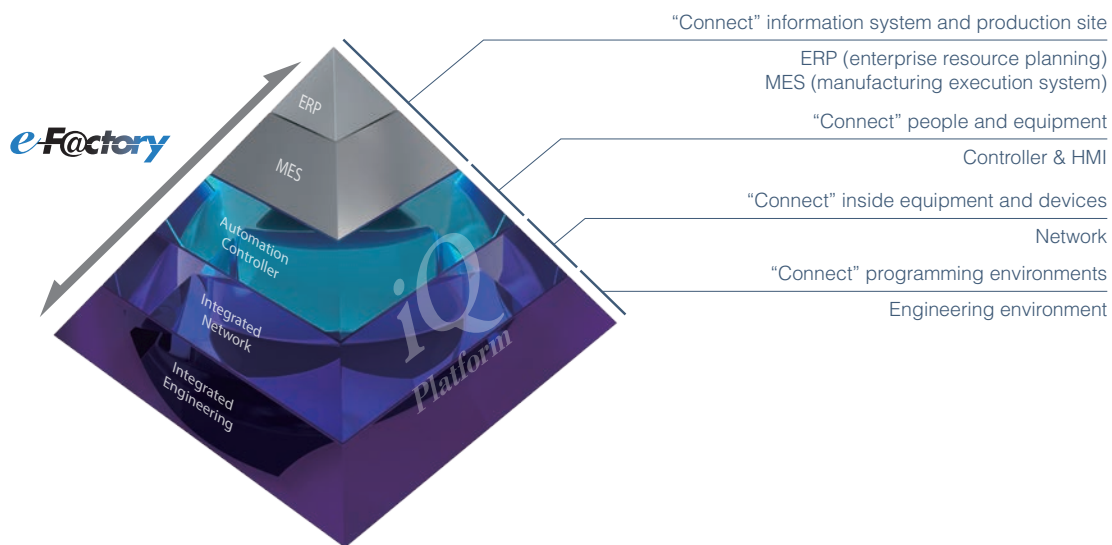

## Fundamentally Solving FA’s Task from the Viewpoint of TCO

### Controller & HMI

Improving productivity and product quality

1. Significant improvement in total system performance due to high-speed MELSEC series system bus performance
2. Equipped with dedicated memory for FB\*1/ label required for program standardization
3. Integrated, enhanced security function

### Network

Loss reduction with high precision and production speed

1. Can capture 1-Gbps high-speed communication on various networks, including CC-Link IE TSN, with no loss
2. Realizing seamless communication of various devices using SLMP\*2

### Engineering environment

Efficient development, operation, and maintenance

1. Possible to detect and generate a large-scale network configuration diagram from the actual machine
2. Realized mutual reflection of parameters between MELSOFT Navigator and each engineering software
3. Automatically following device change of system labels held commonly between each controller and HMI



\*1: Function Block

\*2: SeamLess Message Protocol



# MELSEC iQ-F series

Designed on the concepts of outstanding performance, superior drive control and user centric programming, Mitsubishi Electric MELSEC-F series has been reborn as the MELSEC iQ-F series.

From stand-alone use to networked system applications, MELSEC iQ-F series brings your business to the next level of industry.



## Design concept of micro PLC

### Outstanding performance

- High-speed system bus
- Extensive built-in functions
- Enhanced security functions
- Battery-less

### Improvement of programming environment

- Easy programming by drag and drop
- Reduced development time with module FB
- Parameterized setup for a variety of functions

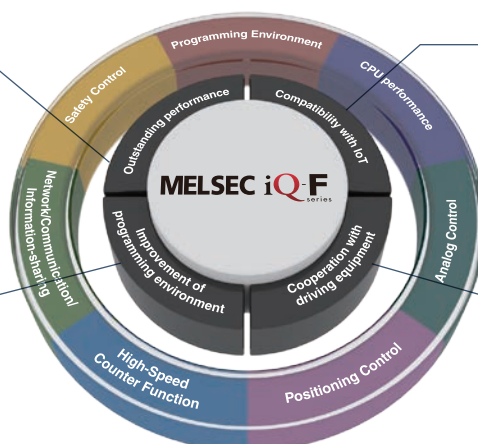

### Compatibility with IoT

- Visualizing operability
- Traceability
- Remote monitoring
- Automation and labor saving

### Cooperation with driving equipment

- Easy built-in positioning (4 axes 200 kpps)
- Interpolation functions
- 4/8-axis synchronization control (no special software required) by motion module, simple motion module

Models with restrictions are marked with symbols such as \*A/\*B/\*C. For details of restrictions, refer to P78 [List of annotations].

CPU Performance

Analog Control

Positioning Control

High-speed Counter Control

Network/Communication/Information-sharing

Safety Control

Programming Environment



## Function and cost performance required for small-scale/stand-alone control



### CPU Performance

For details, go to P20.

Even easier to use with the fulfilling built-in functions.  
Supports the customer to “go one step ahead in manufacturing”.



### Analog Control

For details, go to P30.

Analog control suitable for the application is possible by using extension modules in addition to the analog input/output function of the FX5U CPU module.



### Positioning Control

For details, go to P36.

Not only built-in positioning but full positioning is also possible by using extension modules.



### High-speed Counter Control

For details, go to P42.

The high-performance, high-speed counter built-in the CPU module enables high-speed control with a simple program.



### Network/Communication/Information-sharing

For details, go to P46.

Lineup of modules compatible with various open networks, including CC-Link IE TSN and OPC UA.



### Safety Control

For details, go to P62.

Safety extension modules that have obtained certification (Category 4, PL e, and SIL3) which complies with international safety standards bring safety to machinery and equipment.



### Programming Environment

For details, go to P64.

Realized graphical intuitive operability, and easy programming by just “selecting”.

#### **⚠ Please check before use.**

The MELSEC iQ-F series continues to expand its product lineup and upgrade its functional aspects so that it can be used by customers to take the next step forward in manufacturing. Supported functions, number of units connected, and other restrictions vary depending on the model. Models with restrictions are marked with symbols such as \*A/\*B/\*C. Please confirm the details of the restrictions in P78 [List of annotations], various manuals, or the FA Integrated Selection Tool before selecting and using the product.



Models with restrictions are marked with symbols such as \*A/\*B/\*C. For details of restrictions, refer to P78 [List of annotations].

# System Configuration

## FX5S

Simple model for building small IoT



### FX5 expansion adapter



**Max. 2 modules\***

Communication

FX5-232ADP	For RS-232C communication
FX5-485ADP	For RS-485 communication

---



**Max. 4 modules**

Analog

FX5-4A-ADP*	For analog input/output
FX5-4AD-ADP	For analog input
FX5-4DA-ADP	For analog output
FX5-4AD-PT-ADP	For resistance temperature detector input
FX5-4AD-TC-ADP*	For thermocouple input

### FX5 expansion board



**Max. 1 module**

Communication

FX5-232-BD	For RS-232C communication
FX5-485-BD	For RS-485 communication
FX5-422-BD-GOT	For RS-422 communication (For GOT connection)

---



**Max. 1 module**

SD memory card module

FX5-SDCD	For SD memory card
----------	--------------------

### Peripheral device

HMI

GOT2000

### Outline specifications

Item		Outline specifications
Power supply	Rated voltage	100 to 240 V AC, 50/60 Hz
	Power consumption*1	28 W (30M), 30 W (40M), 33 W (60M)
	Rush current	Max. 30 A for 5 ms or less/100 V AC Max. 50 A for 5 ms or less/200 V AC
	24 V DC service power supply capacity*2	400 mA
Input/output	Input specifications	5.1 mA/24 V DC (X10 and later: 4.0 mA/24 V DC)
	Output specifications	Relay output type: 2 A/1 point, 6 A or less/3 points common, 8 A or less/4 points common, 30 V DC or less, 240 V AC or less (250 V AC or less in case of noncompliance with CE, UL, cUL Standards) Transistor output type: 0.5 A/1 point, 0.6 A or less/3 points common, 0.8 A or less/4 points common 5 to 30 V DC
	Input/output extension	No connection

\*1: The values show the state where the service power of 24 V DC is consumed to the maximum level in case that its configuration has the max. number of connections. (Including the current in the input circuit)  
\*2: Use as power supply for input devices. (Cannot be used as an external power supply for expansion adapters.)

Models with restrictions are marked with symbols such as \*A/\*B/\*C. For details of restrictions, refer to P78 [List of annotations].

Max. number of control points  
**60 points**

Program capacity  
**48 k steps**

Pulse train Max.  
**100 kpps 4 axes**

High-speed counter function (max. 8 ch)

Positioning function (max. 4 axes)

Ethernet port

USB (Mini-B) connector

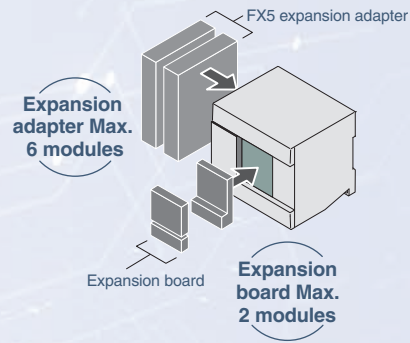

Please choose the I/O type of CPU module suited for your equipment.

### FX5S CPU module

FX5S-30MR/ES FX5S-30MT/ES FX5S-30MT/ESS Input: 16 points/Output: 14 points	FX5S-40MR/ES FX5S-40MT/ES FX5S-40MT/ESS Input: 24 points/Output: 16 points	FX5S-60MR/ES FX5S-60MT/ES FX5S-60MT/ESS Input: 36 points/Output: 24 points
AC D2 R AC D2 T1 AC D2 T2	AC D2 R AC D2 T1 AC D2 T2	AC D2 R AC D2 T1 AC D2 T2

- AC AC power supply
- D2 DC input (sink/source)
- T1 Transistor output (sink)
- T2 Transistor output (source)
- R Relay output

Connector connection

**Option** For details, refer to P14 [System Configuration (Option)].

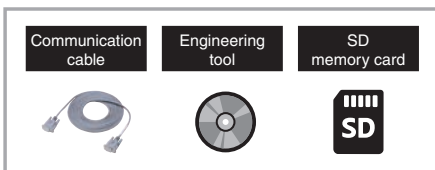

\*: Depending on the CPU module, system configuration, serial number, etc., the type and number of connectable modules may differ, or separate equipment may be required for connection. For details, please refer to Chapter 1 Lineup Details and Model Selection or use the FA Integrated Selection Tool.

Models with restrictions are marked with symbols such as \*A/\*B/\*C. For details of restrictions, refer to P78 [List of annotations].

CPU Performance  
Analog Control  
Positioning Control  
High-speed Counter Control  
Network/Communication/Information-sharing  
Safety Control  
Programming Environment



# System Configuration

## FX5UJ

High function entry model with excellent cost performance that can be used in any scene



### FX5 expansion adapter



**Max. 2 modules\*1**

Communication

FX5-232ADP	For RS-232C communication
FX5-485ADP	For RS-485 communication

---



**Max. 2 modules**

Analog

FX5-4A-ADP	For analog input/output
FX5-4AD-ADP	For analog input
FX5-4DA-ADP	For analog output
FX5-4AD-PT-ADP	For resistance temperature detector input
FX5-4AD-TC-ADP	For thermocouple input

### FX5 expansion board



**Max. 1 module**

Communication

FX5-232-BD	For RS-232C communication
FX5-485-BD	For RS-485 communication
FX5-422-BD-GOT	For RS-422 communication (For GOT connection)

### Peripheral device

HMI

GOT2000

- AC power supply
  - D2 DC input (sink/source)
  - T1 Transistor output (sink)
  - T2 Transistor output (source)
  - R Relay output
- Connector connection  
 Cable connection

### FX5UJ CPU module



FX5UJ-24MR/ES	<span style="color: green;">■</span> <span style="color: orange;">■</span> <span style="color: blue;">■</span> <span style="color: cyan;">■</span> <span style="color: blue;">■</span>
FX5UJ-24MT/ES	<span style="color: green;">■</span> <span style="color: orange;">■</span> <span style="color: blue;">■</span> <span style="color: cyan;">■</span> <span style="color: blue;">■</span>
FX5UJ-24MT/ESS	<span style="color: green;">■</span> <span style="color: orange;">■</span> <span style="color: blue;">■</span> <span style="color: cyan;">■</span> <span style="color: blue;">■</span>

Input: 14 points/Output: 10 points



FX5UJ-40MR/ES	<span style="color: green;">■</span> <span style="color: orange;">■</span> <span style="color: blue;">■</span> <span style="color: cyan;">■</span> <span style="color: blue;">■</span>
FX5UJ-40MT/ES	<span style="color: green;">■</span> <span style="color: orange;">■</span> <span style="color: blue;">■</span> <span style="color: cyan;">■</span> <span style="color: blue;">■</span>
FX5UJ-40MT/ESS	<span style="color: green;">■</span> <span style="color: orange;">■</span> <span style="color: blue;">■</span> <span style="color: cyan;">■</span> <span style="color: blue;">■</span>

Input: 24 points/Output: 16 points



FX5UJ-60MR/ES	<span style="color: green;">■</span> <span style="color: orange;">■</span> <span style="color: blue;">■</span> <span style="color: cyan;">■</span> <span style="color: blue;">■</span>
FX5UJ-60MT/ES	<span style="color: green;">■</span> <span style="color: orange;">■</span> <span style="color: blue;">■</span> <span style="color: cyan;">■</span> <span style="color: blue;">■</span>
FX5UJ-60MT/ESS	<span style="color: green;">■</span> <span style="color: orange;">■</span> <span style="color: blue;">■</span> <span style="color: cyan;">■</span> <span style="color: blue;">■</span>

Input: 36 points/Output: 24 points

### Outline specifications

Item	Outline specifications	
Power supply	Rated voltage	100 to 240 V AC, 50/60 Hz
	Power consumption*1	30 W (24M), 32 W (40M), 35 W (60M)
	24 V DC service power supply capacity*2	400 mA (24M, 40M, 60M) When an external power supply is used for the input circuit of the CPU module: 460 mA (24M), 500 mA (40M), 550 mA (60M)
Input/output	Input specifications	5.3 mA/24 V DC (X10 and later: 4.0 mA/24 V DC)
	Output specifications	Relay output type: 2 A/1 point, 6 A or less/3 points common, 8 A or less/4 points common, 30 V DC or less, 240 V AC or less (250 V AC or less in case of noncompliance with CE, UL, cUL Standards) Transistor output type: 0.5 A/1 point, 0.6 A or less/3 points common, 0.8 A or less/4 points common 5 to 30 V DC
	Input/output extension	Extension devices for FX5 can be connected: when adding an extension connector type, the connector conversion module (FX5-CNV-IF) is required.

\*1: The values show the state where the service power of 24 V DC is consumed to the maximum level in case that its configuration has the max. number of connections provided to CPU module. (Including the current in the input circuit)  
 \*2: When I/O modules are connected, they consume current from the 24 V DC service power supply.

Models with restrictions are marked with symbols such as \*A/\*B/\*C. For details of restrictions, refer to P78 [List of annotations].

Max. number of control points  
**256 points**

Program capacity  
**48 k steps**

Pulse train  
**200 kpps**

Max.  
**3 axes**

High-speed counter function (max. 8 ch)

Positioning function (max. 3 axes)

Ethernet port

USB (Mini-B) connector

SD memory card slot

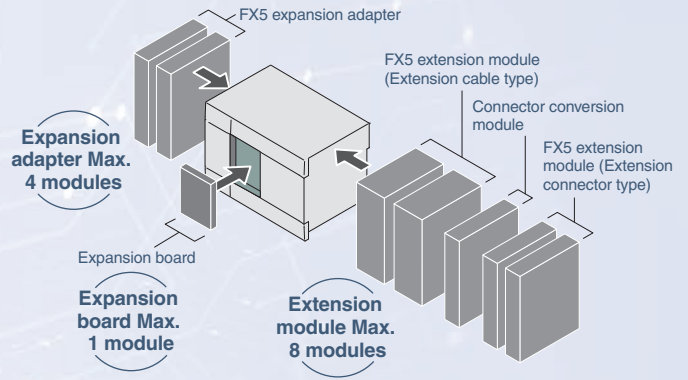

Please choose the I/O type of CPU module or I/O module suited for your equipment. Refer to the page below for the details of I/O type of each product.

### FX5 extension module (Extension cable type)

I/O module	Intelligent function module	Safety extension module*1
<p><b>Powered I/O module</b> FX5-32ER/ES FX5-32ET/ES FX5-32ET/ESS</p> <p><b>Input module</b> FX5-8EX/ES FX5-16EX/ES</p> <p><b>I/O module</b> FX5-16ER/ES FX5-16ET/ES FX5-16ET/ESS</p> <p><b>Output module</b> FX5-8EYR/ES FX5-8EYT/ES FX5-8EYT/ESS FX5-16EYR/ES FX5-16EYT/ES FX5-16EYT/ESS</p> <p><b>High-speed pulse input/output module</b> FX5-16ET/ES-H*1+3 FX5-16ET/ESS-H*1+3</p>	<p><b>Analog</b> FX5-4AD FX5-4DA FX5-8AD</p> <p><b>Positioning</b> FX5-20PG-P FX5-20PG-D</p> <p><b>Communication/Network</b> FX5-CCLGN-MS*1+3 <b>CC-Link IE TSN</b> FX5-ENET*1 <b>CC-Link IE Basic</b></p> <p><b>Temperature control</b> FX5-4LC</p> <p><b>Simple motion</b> FX5-40SSC-S*1 FX5-80SSC-S*1 <b>SCNET III/H</b></p> <p>FX5-ENET/IP*1 FX5-CCLIEF <b>CC-Link IE Field</b> FX5-CCL-MS*1 <b>CC-Link</b> FX5-ASL-M*1 <b>AnyWireASLINK</b> FX5-DP-M*1</p>	<p><b>Safety main module</b> FX5-SF-MU4T5</p> <p><b>Safety input expansion module</b> FX5-SF-8DI4</p> <p><b>Extension power supply module</b> FX5-1PSU-5V</p>

FX5 extension module (Extension cable type)	FX5 extension module (Extension connector type)
<p><b>Connector conversion module</b> FX5-CNV-IF</p>	<p><b>I/O module</b> FX5-C32ET/D FX5-C32ET/DSS FX5-C32ET/DS-TS*2 FX5-C32ET/DSS-TS*2</p> <p><b>Input module</b> FX5-C16EX/D FX5-C16EX/DS FX5-C32EX/D FX5-C32EX/DS FX5-C32EX/DS-TS*2</p> <p><b>Output module</b> FX5-C16EYT/D FX5-C16EYT/DSS FX5-C16EYR/D-TS*2 FX5-C32EYT/D FX5-C32EYT/DSS FX5-C32EYT/D-TS*2 FX5-C32EYT/DSS-TS*2</p>

**Option** For details, refer to P14 [System Configuration (Option)].

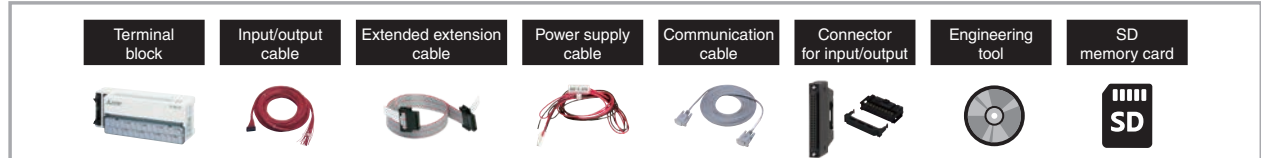

\*1: Depending on the CPU module, system configuration, serial number, etc., the type and number of connectable modules may differ, or separate equipment may be required for connection. For details, please refer to Chapter 1 Lineup Details and Model Selection or use the FA Integrated Selection Tool.  
 \*2: Spring clamp terminal block type.  
 \*3: The availability of the connection depends on the version of the CPU module. For details, please refer to Chapter 1 Lineup Details and Model Selection or use the FA Integrated Selection Tool.

Models with restrictions are marked with symbols such as \*A/\*B/\*C. For details of restrictions, refer to P78 [List of annotations].

CPU Performance  
Analog Control  
Positioning Control  
High-speed Counter Control  
Network/Communication/Information-sharing  
Safety Control  
Programming Environment

# System Configuration

## FX5U

High functioning all-in-one model equipped with advanced built-in functions and diverse expandability



### FX5 expansion adapter



**Max. 2 modules**

**Communication**

FX5-232ADP For RS-232C communication  
FX5-485ADP For RS-485 communication

---



**Max. 4 modules**

**Analog**

FX5-4A-ADP\*1 For analog input/output  
FX5-4AD-ADP For analog input  
FX5-4DA-ADP For analog output  
FX5-4AD-PT-ADP For resistance temperature detector input  
FX5-4AD-TC-ADP\*1 For thermocouple input

### FX5 expansion board



**Max. 1 module**

**Communication**

FX5-232-BD For RS-232C communication  
FX5-485-BD For RS-485 communication  
FX5-422-BD-GOT For RS-422 communication (For GOT connection)

---

**Peripheral device**

**HMI**

GOT2000

AC AC power supply

D1 DC input (sink)

T1 Transistor output (sink)

R Relay output

DC DC power supply

D2 DC input (sink/source)

T2 Transistor output (source)

■ Connector connection    ■ Cable connection

### FX5U CPU module



FX5U-32MR/ES AC D2 R

FX5U-32MT/ES AC D2 T1

FX5U-32MT/ESS AC D2 T2

FX5U-32MR/DS DC D2 R

FX5U-32MT/DS DC D2 T1

FX5U-32MT/DSS DC D2 T2

Input: 16 points/Output: 16 points



FX5U-64MR/ES AC D2 R

FX5U-64MT/ES AC D2 T1

FX5U-64MT/ESS AC D2 T2

FX5U-64MR/DS DC D2 R

FX5U-64MT/DS DC D2 T1

FX5U-64MT/DSS DC D2 T2

Input: 32 points/Output: 32 points



FX5U-80MR/ES AC D2 R

FX5U-80MT/ES AC D2 T1

FX5U-80MT/ESS AC D2 T2

FX5U-80MR/DS DC D2 R

FX5U-80MT/DS DC D2 T1

FX5U-80MT/DSS DC D2 T2

Input: 40 points/Output: 40 points

**Option** For details, refer to P14 [System Configuration (Option)].

Terminal block

I/O cable

Extended extension cable

Power supply cable

Communication cable

Connector for input/output

Battery

Engineering tool

SD memory card

### Outline specifications

Item	Outline specifications	
	AC power supply type	DC power supply type
Power supply	Rated voltage	100 to 240 V AC, 50/60 Hz
	Power consumption*1	30 W (32M), 40 W (64M), 45 W (80M)
	24 V DC service power supply capacity	400 mA [300 mA*3] (32M), 600 mA [300 mA*3] (64M, 80M) When an external power supply is used for the input circuit of the CPU module: 480 mA [380 mA*3] (32M), 740 mA [440 mA*3] (64M), 770 mA [470 mA*3] (80M)
	24 V DC internal power supply capacity	—
Input/output	Input specifications	5.3 mA/24 V DC (X20 and later: 4.0 mA/24 V DC)
	Output specifications	Relay output type: 2 A/1 point, 8 A or less/4 points common, 8 A or less/8 points common, 30 V DC or less, 240 V AC or less (250 V AC or less in case of noncompliance with CE, UL, cUL Standards) Transistor output type: 0.5 A/1 point, 0.8 A or less/4 points common, 1.6 A or less/8 points common 5 to 30 V DC
	Input/output extension	Extension devices for FX5 can be connected: when adding an extension connector type, the connector conversion module (FX5-CNV-IF) is required.

\*1: The values show the state where the service power of 24 V DC is consumed to the maximum level in case that its configuration has the max. number of connections provided to CPU module. (Including the current in the input circuit)  
 \*2: The values in the parentheses ( ) indicate the power supply capacity to be resulted when the power supply voltage falls in the range from 16.8 to 19.2 V DC.  
 \*3: The values in the brackets [ ] will result when the ambient temperature is less than 0°C during operations.

Models with restrictions are marked with symbols such as \*A/\*B/\*C. For details of restrictions, refer to P78 [List of annotations].

10



Max. number of control points **512**<sup>\*4</sup> points | Program capacity **64/128** k steps | Pulse train **200** kpps | Max. **4** axes

High-speed counter function (max. 8 ch)	Positioning function (max. 4 axes)	Ethernet port
RS-485 port	SD memory card slot	Analog input/output Input 2 ch/output 1 ch

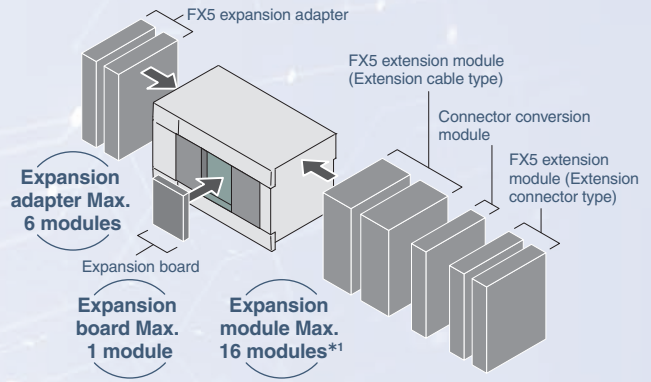

Please choose the I/O type of CPU module or I/O module suited for your equipment. Refer to the page below for the details of I/O type of each product.

### FX5 extension module (Extension cable type)

I/O module	Intelligent function module	Safety extension module <sup>*1</sup>
<p><b>Powered I/O module</b> FX5-32ER/ES<sup>*1</sup> FX5-32ET/ES<sup>*1</sup> FX5-32ET/ESS<sup>*1</sup> FX5-32ER/DS<sup>*1</sup> FX5-32ET/DS<sup>*1</sup> FX5-32ET/DSS<sup>*1</sup></p> <p><b>Input module</b> FX5-8EX/ES FX5-16EX/ES</p> <p><b>Output module</b> FX5-8EYR/ES FX5-8EYT/ES FX5-8EYT/ESS FX5-16EYR/ES FX5-16EYT/ES FX5-16EYT/ESS</p> <p><b>I/O module</b> FX5-16ER/ES FX5-16ET/ES FX5-16ET/ESS</p> <p><b>High-speed pulse input/output module</b> FX5-16ET/ES-H FX5-16ET/ESS-H</p>	<p><b>Analog</b> FX5-4AD FX5-4DA FX5-8AD</p> <p><b>Positioning</b> FX5-20PG-P FX5-20PG-D</p> <p><b>Temperature control</b> FX5-4LC</p> <p><b>Motion</b> FX5-40SSC-G FX5-80SSC-G FX5-40SSC-S FX5-80SSC-S</p> <p><b>Simple motion</b> FX5-40SSC-S FX5-80SSC-S</p> <p><b>Network/Communication/Information-sharing</b> FX5-CCLGN-MS <b>CC-Link IE TSN</b> FX5-ENET <b>CC-Link IE Basic</b> FX5-ENET/IP FX5-CCLIEF <b>CC-Link IE Field</b> FX5-CCL-MS <b>CC-Link</b> FX5-ASL-M <b>AnyWireASLINK</b> FX5-DP-M FX5-OPC <b>OPC UA</b></p>	<p><b>Safety main module</b> FX5-SF-MU4T5</p> <p><b>Safety input expansion module</b> FX5-SF-8DI4</p> <p><b>Extension power supply module</b> <b>Extension power supply module</b> FX5-1PSU-5V<sup>*1</sup></p>

FX5 extension module (Extension cable type)	FX5 extension module (Extension connector type)	Bus conversion module	FX3 extension module <sup>*3</sup>
<p><b>Connector conversion module</b> Connector conversion module FX5-CNV-IF</p> <p><b>Extension power supply module</b> Extension power supply module FX5-C1PS-5V<sup>*1</sup></p>	<p><b>Bus conversion module</b> Bus conversion module FX5-CNV-BUSC</p> <p><b>Bus conversion module</b> Bus conversion module FX5-CNV-BUS</p>	<p><b>Intelligent function module</b></p> <p><b>Analog</b> FX3U-4AD for input FX3U-4DA for output</p> <p><b>Temperature control</b> FX3U-4LC Temperature control</p> <p><b>Positioning</b> FX3U-1PG for pulse output</p> <p><b>High-speed counter</b> FX3U-2HC For high-speed input</p> <p><b>Communication/Network</b> FX3U-64CCL FX3U-16CCL-M FX3U-128ASL-M FX3U-128BTY-M FX3U-32DP</p> <p>CC-Link intelligent device CC-Link master AnyWireASLINK master AnyWire Bitty series Master PROFIBUS-DP slave</p>	
<p><b>I/O module</b> FX5-C32ET/D FX5-C32ET/DSS FX5-C32ET/DS-TS<sup>*2</sup> FX5-C32ET/DSS-TS<sup>*2</sup></p> <p><b>Input module</b> FX5-C16EX/D FX5-C16EX/DS FX5-C32EX/D FX5-C32EX/DS FX5-C32EX/DS-TS<sup>*2</sup></p> <p><b>Output module</b> FX5-C16EYT/D FX5-C16EYT/DSS FX5-C16EYR/D-TS<sup>*2</sup> FX5-C32EYT/D FX5-C32EYT/DSS FX5-C32EYT/D-TS<sup>*2</sup> FX5-C32EYT/DSS-TS<sup>*2</sup></p>	<p><b>Extension power supply module</b> Extension power supply module FX3U-1PSU-5V<sup>*1</sup></p>		

\*1: Depending on the CPU module, system configuration, serial number, etc., the type and number of connectable modules may differ, or separate equipment may be required for connection. For details, please refer to Chapter 1 Lineup Details and Model Selection or use the FA Integrated Selection Tool.

\*2: Pulse clamp terminal block type.

\*3: For the module requiring parameter in FX3 extension module, parameter settings by program are necessary. When connecting the FX3 extension module, the bus speed for FX3 applies for access. For details, refer to Chapters 4 through 7.

\*4: Max. number of control points, including remote I/O points.

Models with restrictions are marked with symbols such as \*A/\*B/\*C. For details of restrictions, refer to P78 [List of annotations].

# System Configuration

## FX5UC

High functioning compact model to help miniaturize equipment by condensing various functions into a compact body

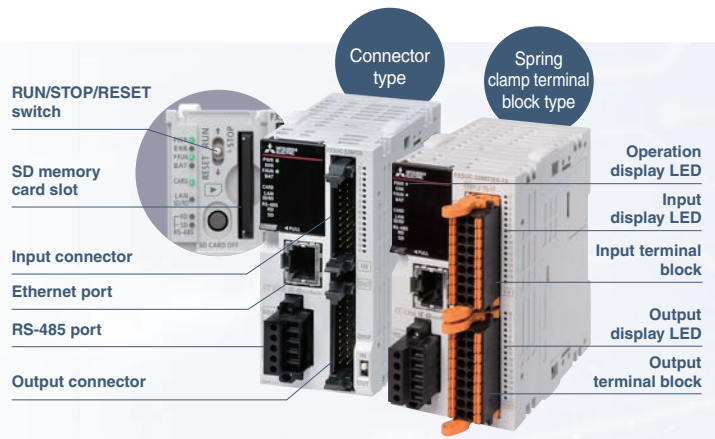

### FX5 expansion adapter



**Max. 2 modules**

**Communication**

FX5-232ADP For RS-232C communication  
FX5-485ADP For RS-485 communication

---



**Max. 4 modules**

**Analog**

FX5-4A-ADP\*1 For analog input/output  
FX5-4AD-ADP For analog input  
FX5-4DA-ADP For analog output  
FX5-4AD-PT-ADP For resistance temperature detector input  
FX5-4AD-TC-ADP\*1 For thermocouple input

### Peripheral device

**HMI**

GOT2000

### FX5UC CPU module



FX5UC-32MT/D  
FX5UC-32MT/DSS  
FX5UC-32MT/DS-TS\*2  
FX5UC-32MT/DSS-TS\*2  
FX5UC-32MR/DS-TS\*2

Input: 16 points/Output: 16 points



FX5UC-64MT/D  
FX5UC-64MT/DSS

Input: 32 points/Output: 32 points

DC D1 T1  
DC D2 T2  
DC D2 T1  
DC D2 T2  
DC D2 R



FX5UC-96MT/D  
FX5UC-96MT/DSS

Input: 48 points/Output: 48 points

DC D1 T1  
DC D2 T2

### FX5 extension module (Extension connector type)

I/O module



**Input module**

FX5-C16EX/D  
FX5-C16EX/DS  
FX5-C32EX/D  
FX5-C32EX/DS  
FX5-C32EX/DS-TS\*2

**Output module**

FX5-C16EYT/D  
FX5-C16EYT/DSS  
FX5-C16EYR/D-TS\*2  
FX5-C32EYT/D  
FX5-C32EYT/DSS  
FX5-C32EYT/D-TS\*2  
FX5-C32EYT/DSS-TS\*2

**I/O module**

FX5-C32ET/D  
FX5-C32ET/DSS  
FX5-C32ET/DS-TS\*2  
FX5-C32ET/DSS-TS\*2

DC DC power supply  
D1 DC input (sink)  
D2 DC input (sink/source)  
T1 Transistor output (sink)  
T2 Transistor output (source)  
R Relay output

Connector connection  
Cable connection

### Outline specifications

Item		Outline specifications
Power supply	Rated voltage	24 V DC
	Power consumption*1	32M: 5 W/24 V DC (30 W/24 V DC +20%, -15%) 64M: 8 W/24 V DC (33 W/24 V DC +20%, -15%) 96M: 11 W/24 V DC (36 W/24 V DC +20%, -15%)
	5 V DC power supply capacity	720 mA
	24 V DC internal power supply	500 mA
Input/output	Input specifications	5.3 mA/24 V DC (X20 and later: 4.0 mA/24 V DC)
	Output specifications	Relay output type: 2 A/1 point, 4 A or less/8 points common*2 30 V DC or less, 240 V AC or less (250 V AC or less in case of noncompliance with CE, UL, cUL Standards) Transistor output type: Y000 to Y003 0.3 A/1 point, Y004 and later 0.1 A/1 point, 0.8 A/8 points common*3 5 to 30 V DC
	Input/output extension	Extension device for FX5 can be connected (extension power supply module (FX5-C1PS-5V) or connector conversion module (FX5-CNV-IFC) is required when connecting an extension cable type)

\*1: The value results when the CPU module is used alone. The values in the parentheses ( ) result when the maximum no. of connections have been made to the CPU module. (External 24 V DC power supplies of extension devices are not included.)  
\*2: 8 A or less when two common terminals are connected to the external part.  
\*3: 1.6 A or less when two common terminals are connected to the external part.

Models with restrictions are marked with symbols such as \*A/\*B/\*C. For details of restrictions, refer to P78 [List of annotations].

CPU Performance  
Analog Control  
Positioning Control  
High-speed Counter Control  
Network/Communication/Information-sharing  
Safety Control  
Programming Environment

Max. number of control points  
**512**<sup>\*4</sup> points

Program capacity  
**64/128** k steps

Pulse train  
**200** kpps

Max.  
**4** axes

High-speed counter function (max. 8 ch)

Positioning function (max. 4 axes)

Ethernet port

RS-485 port

SD memory card slot

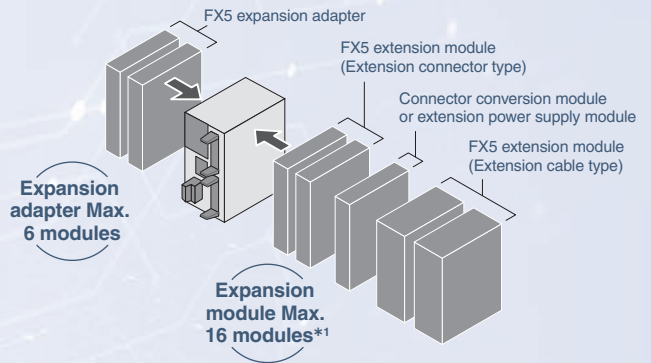

Please choose the I/O type of CPU module or I/O module suited for your equipment. Refer to the page below for the details of I/O type of each product.

**FX5 extension module (Extension connector type)**

**Extension power supply module**

Extension power supply module  
FX5-C1PS-5V\*1

or

**Connector conversion module**

Connector conversion module  
FX5-CNV-IFC

**Bus conversion module**

Bus conversion module  
FX5-CNV-BUSC

Bus conversion module  
FX5-CNV-BUS

**FX5 extension module (Extension cable type)**

I/O module			Intelligent function module		
<b>Powered I/O module</b>	<b>Input module</b>	<b>I/O module</b>	<b>Analog</b>	<b>Positioning</b>	<b>Network/Communication/Information-sharing</b>
FX5-32ER/DS FX5-32ET/DS FX5-32ET/DSS	FX5-8EX/ES FX5-16EX/ES	FX5-16ER/ES FX5-16ET/ES FX5-16ET/ESS	FX5-4AD FX5-4DA FX5-8AD	FX5-20PG-P FX5-20PG-D	FX5-CCLGN-MS CC-Link IE TSN FX5-ENET CC-Link IE Field Basic
	<b>Output module</b>	<b>High-speed pulse input/output module</b>	<b>Temperature control</b>	<b>Motion</b>	FX5-ENET/IP FX5-CCLIEF CC-Link IE Field Basic FX5-CCL-MS CC-Link FX5-ASL-M AnyWire ASLINK
	FX5-8EYR/ES FX5-8EYT/ES FX5-8EYT/ESS FX5-16EYR/ES FX5-16EYT/ES FX5-16EYT/ESS	FX5-16ET/ES-H FX5-16ET/ESS-H	FX5-4LC	FX5-40SSC-G FX5-80SSC-G CC-Link IE TSN	FX5-ASL-M AnyWire ASLINK FX5-DP-M FX5-OPC OPC UA
				<b>Simple motion</b>	FX5-40SSC-S FX5-80SSC-S SNCNET III/H
<b>Safety extension module*1</b>					
Safety main module	Safety input expansion module				
FX5-SF-MU4T5	FX5-SF-8DI4				

**FX3 extension module\*3**

**Intelligent function module**

Analog	Temperature control	Communication/Network	
FX3U-4AD for input FX3U-4DA for output	FX3U-4LC Temperature control	FX3U-64CCL FX3U-16CCL-M FX3U-128ASL-M FX3U-128BTY-M FX3U-32DP	CC-Link intelligent device CC-Link master AnyWire ASLINK master AnyWire Bitty series Master PROFIBUS-DP slave
<b>Positioning</b>	<b>High-speed counter</b>		
FX3U-1PG for pulse output	FX3U-2HC For high-speed input		

**Option** For details, refer to P14 [System Configuration (Option)].

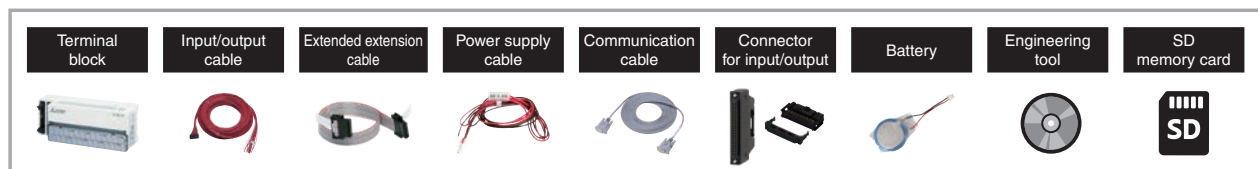

\*1: Depending on the CPU module, system configuration, serial number, etc., the type and number of connectable modules may differ, or separate equipment may be required for connection. For details, please refer to Chapter 1 Lineup Details and Model Selection or use the FA Integrated Selection Tool.

\*2: Spring clamp terminal block type.

\*3: For the module requiring parameter in FX3 extension module, parameter settings by program are necessary. When connecting the FX3 extension module, the bus speed for FX3 applies for access. For details, refer to Chapters 4 through 7.

\*4: Max. number of control points, including remote I/O points.

Models with restrictions are marked with symbols such as \*A/\*B/\*C. For details of restrictions, refer to P78 [List of annotations].

CPU Performance  
Analog Control  
Positioning Control  
High-speed Counter Control  
Network/Communication/Information-sharing  
Safety Control  
Programming Environment



# System Configuration (Option)

Numerous options are available, including connection cables and connectors. These options can be selected according to your application. For details on the options that can be connected to each CPU module, refer to the manual.

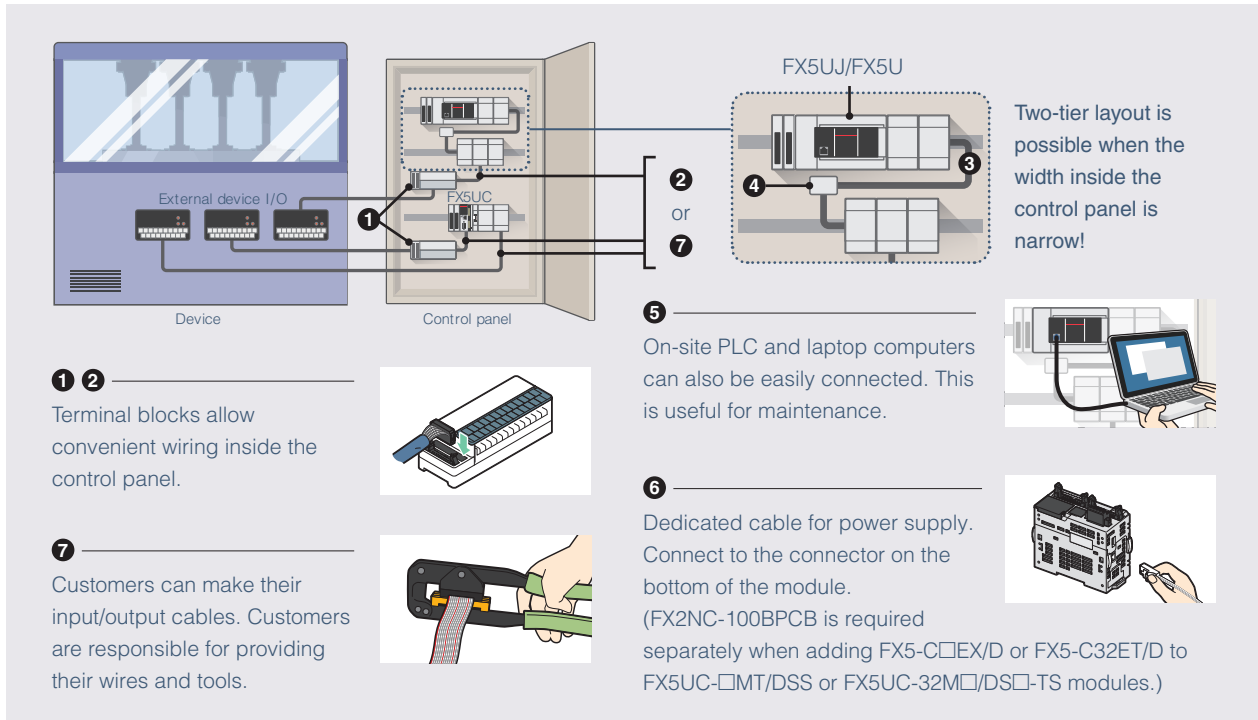

## 1 Terminal block

For converting the FX5UC or 20-pin MIL connector of an I/O extension into a terminal block.



### Terminal block conversion

- FX-16E-TB
- FX-16E-TB/UL
- FX-32E-TB
- FX-32E-TB/UL

### Terminal block/output type conversion

Use when the transistor output of the FX5UC is to be a relay, triac, or transistor.

#### Relay output type

- FX-16EYR-TB
- FX-16EYR-ES-TB/UL

#### Triac output type

- FX-16EYS-TB
- FX-16EYS-ES-TB/UL

#### Transistor output type (sink)

- FX-16EYT-TB

#### Transistor output type (source)

- FX-16EYT-ESS-TB/UL

## 2 I/O cable

Connect the CPU module or FX5 extension module to the terminal block.



### For terminal block connection

- FX-16E-□CAB (20-pin on both ends)
- FX-16E-□CAB-R (20-pin on both ends)
- : 150 (1.5 m)/300 (3 m)/500 (5 m)



### For connecting external device (one side single wire)

- FX-16E-500CAB-S (5 m, 20-pin single wire)



## 3 Extended extension cable

Use when the CPU module and extension module are to be installed at a distance from each other.



- FX5-30EC (30 cm)<sup>\*D1</sup>
- FX5-65EC (65 cm)<sup>\*D2</sup>

4 Connector conversion adapter is required when connected with an input/output module (extension cable type), high-speed pulse input/output module, or an intelligent function module.

## 4 Connector conversion adapter

Use to convert connectors between extension cables and extension cable type modules.



- FX5-CNV-BC

Models with restrictions are marked with symbols such as \*A/\*B/\*C. For details of restrictions, refer to P78 [List of annotations].

## 5 Communication cable

Use to connect to a computer.



USB communication **FX5S** **FX5UJ**

- MR-J3USBCBL3M (3 m)
- GT09-C30USB-5P (3 m) [From Mitsubishi Electric System & Service Co., Ltd.]



Serial communication  
[For FX5-232ADP/FX5-232-BD]

- FX-232CAB-1 (3 m)

## 6 Power supply cable

Use to connect to a power supply.



Power cable for CPU modules

FX2NC-100MPCB (1 m)\*E1



Power supply cable

FX2NC-100BPCB (1 m)  
(Attached to FX5UC-□MT/D)



Power crossover cable

FX2NC-10BPCCB1 (0.1 m)  
(Attached to FX5-C□EX/D,  
FX5-C32ET/D)

## 7 Connector for input/output

Use to create your own input/output cables for connection to external devices.

### Connector for self-making I/O cable



For  
20-pin

For flat cable

- FX2C-I/O-CON (0.1 mm<sup>2</sup>)



For  
20-pin

For single wire

- FX2C-I/O-CON-S (0.3 mm<sup>2</sup>)
- FX2C-I/O-CON-SA (0.5 mm<sup>2</sup>)



For  
40-pin

[For FX5-20PG-P/FX5-20PG-D]

For soldering type (straight out)

- A6CON1 (0.088 to 0.3 mm<sup>2</sup>)

Crimping type (straight out)

- A6CON2 (0.088 to 0.24 mm<sup>2</sup>)

For soldering type (straight/diagonal out)

- A6CON4 (0.088 to 0.3 mm<sup>2</sup>)



For  
40-pin

[For FX3U-2HC]

For single wire

- FX-I/O-CON2-S (0.3 mm<sup>2</sup>)
- FX-I/O-CON2-SA (0.5 mm<sup>2</sup>)

Other options are available in addition to the provided examples.

## SD memory card module

**FX5S**

Required when using an SD memory card for an FX5S CPU module.



- FX5-SDCD

## SD memory card

Use for data logging and backup/restore functions.



- NZ1MEM-2GBSD (2 Gbytes)
- NZ1MEM-4GBSD (4 Gbytes)
- NZ1MEM-8GBSD (8 Gbytes)
- NZ1MEM-16GBSD (16 Gbytes)

[Related products are also available.]  
In addition to these options, connection cables and positioning signal conversion modules from partner manufacturers are available. For details on related products, refer to Chapter 9 below.

## Battery

**FX5U** **FX5UC**

Use to increase the amount of device memory or clock data that can be held.



- FX3U-32BL



[Point]

FX5 CPU module is battery-less.  
Please use batteries as needed for FX5U/FX5UC.

## Engineering tool

Software for programming CPU modules.



- GX Works3

Models with restrictions are marked with symbols such as \*A/\*B/\*C. For details of restrictions, refer to P78 [List of annotations].

# Performance Specifications



**FX5S**

## ■ FX5S CPU module performance specifications

Item		Specification
Control system		Stored-program repetitive operation
Input/output control system		Refresh system (Direct access input/output allowed by specification of direct access input/output [DX, DY])
Programming specifications	Programming language	Ladder diagram (LD), structured text (ST), function block diagram/ladder diagram (FBD/LD)
	Programming expansion function	Function block (FB), function (FUN), label programming (local/global)
	Constant scan	0.5 to 2000 ms (can be set in 0.1 ms increments)
	Fixed cycle interrupt	1 to 60000 ms (can be set in 1 ms increments)
	Timer performance specifications	100 ms, 10 ms, 1 ms
	No. of program executions	32
Operation specifications	No. of FB files	16 (Up to 15 for user)
	Execution type	Standby type, initial execution type, scan execution type, fixed-cycle execution type, event execution type
Command processing time	Interrupt type	Internal timer interrupt, input interruption, high-speed comparison match interrupt
	LD X0	84 ns
Memory capacity	MOV D0 D1	100 ns
	Program capacity	48 k steps (96 kbytes, flash memory)
	SD memory card	Memory card capacity (SD/SDHC memory card: Max. 16 Gbytes)
	Device/label memory	120 kbytes
Flash memory (Flash ROM)	Data memory/standard ROM	5 Mbytes
	write count	Maximum 20000 times
File storage capacity	Device/label memory	1
	Data memory	P: 32, FB: 16
	P: No. of program files FB: No. of FB files	
	SD memory card	NZ1MEM-2GBSD: 511*1 NZ1MEM-4GBSD, NZ1MEM-8GBSD, NZ1MEM-16GBSD: 65534*1
Clock function	Display data	Year, month, day, hour, minute, second, day of week (leap year automatic detection)
	Precision	Differences per month ±45 sec./25°C (TYP)
No. of input/output points		60 points or less
Power failure retention (clock data*2)	Retention method	Large-capacity capacitor
	Retention time	15 days (Ambient temperature: 25°C)
Power failure retention (device)	Power failure retention capacity	Maximum 5 k words

\*1: The value listed above indicates the number of files stored in the root folder.

\*2: Clock data is retained using the power accumulated in a large-capacity capacitor incorporated into the PLC. When voltage of the large-capacity capacitor drops, clock data is no longer accurately retained. The retention period of a fully charged capacitor (electricity is conducted across the PLC for at least 30 minutes) is 15 days (ambient temperature: 25°C). How long the capacitor can hold the data depends on the operating ambient temperature. When the operating ambient temperature is high, the holding period is short.

## ■ Number of device points

Item		Base	Max. number of points	
No. of user device points	Input relay (X)	8	1024 points or less	
	Output relay (Y)	8	1024 points or less	
	Internal relay (M)	10	32768 points (can be changed with a parameter)*1	
	Latch relay (L)	10	32768 points (can be changed with a parameter)*1	
	Link relay (B)	16	32768 points (can be changed with a parameter)*1	
	Annunciator (F)	10	32768 points (can be changed with a parameter)*1	
	Link special relay (SB)	16	32768 points (can be changed with a parameter)*1	
	Step relay (S)	10	4096 points (fixed)	
	Timer system	Timer (T)	10	1024 points (can be changed with a parameter)*1
	Accumulation timer system	Accumulation timer (ST)	10	1024 points (can be changed with a parameter)*1
	Counter system	Counter (C)	10	1024 points (can be changed with a parameter)*1
		Long counter (LC)	10	1024 points (can be changed with a parameter)*1
	Data register (D)		10	8000 points (can be changed with a parameter)*1
	Link register (W)		16	32768 points (can be changed with a parameter)*1
	Link special register (SW)		16	32768 points (can be changed with a parameter)*1
No. of system device points	Special relay (SM)	10	10000 points (fixed)	
	Special register (SD)	10	12000 points (fixed)	
No. of index register points	Index register (Z)*2	10	24 points	
	Long index register (LZ)*2	10	12 points	
No. of file register points	File register (R)	10	32768 points (can be changed with a parameter)*1	
	Extended file register (ER)	10	32768 points (are stored in SD memory card)	
No. of nesting points	Nesting (N)	10	15 points (fixed)	
No. of pointer points	Pointer (P)	10	4096 points	
	Interrupt pointer (I)	10	32 points	
Others	Decimal constant (K)	Signed	16 bits: -32768 to +32767, 32 bits: -2147483648 to +2147483647	
		Unsigned	16 bits: 0 to 65535, 32 bits: 0 to 4294967295	
	Hexadecimal constant (H)		16 bits: 0 to FFFF, 32 bits: 0 to FFFFFFFF	
	Real constant (E)	Single precision	E-3.40282347+38 to E-1.17549435-38, 0, E1.17549435-38 to E3.40282347+38	
Character string			Shift-JIS code max. 255 single-byte characters (256 including NULL) Unicode max. 255 characters (256 including NULL)	

\*1: Can be changed with parameters within the capacity range of the CPU built-in memory.

\*2: The sum of index register (Z) and long index register (LZ) is 24 words.

Models with restrictions are marked with symbols such as \*A/\*B/\*C. For details of restrictions, refer to P78 [List of annotations].



**FX5UJ**

**FX5UJ CPU module performance specifications**

Item		Specification
Control system		Stored-program repetitive operation
Input/output control system		Refresh system (Direct access input/output allowed by specification of direct access input/output [DX, DY])
Programming specifications	Programming language	Ladder diagram (LD), structured text (ST), function block diagram/ladder diagram (FBD/LD)
	Programming expansion function	Function block (FB), function (FUN), label programming (local/global)
	Constant scan	0.5 to 2000 ms (can be set in 0.1 ms increments)
	Fixed cycle interrupt	1 to 60000 ms (can be set in 1 ms increments)
	Timer performance specifications	100 ms, 10 ms, 1 ms
	No. of program executions	32
Operation specifications	No. of FB files	16 (Up to 15 for user)
	Execution type	Standby type, initial execution type, scan execution type, fixed-cycle execution type, event execution type
Command processing time	Interrupt type	Internal timer interrupt, input interruption, high-speed comparison match interrupt, interrupt by modules*1
	LD X0	34 ns
Memory capacity	MOV D0 D1	34 ns
	Program capacity	48 k steps (96 kbytes, flash memory)
	SD memory card	Memory card capacity (SD/SDHC memory card: Max. 16 Gbytes)
	Device/label memory	120 kbytes
Flash memory (Flash ROM)	Data memory/standard ROM	5 Mbytes
	write count	Maximum 20000 times
File storage capacity	Device/label memory	1
	Data memory P: No. of program files FB: No. of FB files	P: 32, FB: 16
	SD memory card	NZ1MEM-2GBSD: 511*2 NZ1MEM-4GBSD, NZ1MEM-8GBSD, NZ1MEM-16GBSD: 65534*2
Clock function	Display data	Year, month, day, hour, minute, second, day of week (leap year automatic detection)
	Precision	Differences per month ±45 sec./25°C (TYP)
No. of input/output points	(1) No. of input/output points	256 points or less
	(2) No. of remote I/O points	256 points or less
	Total No. of points of (1) and (2)	256 points or less
Power failure retention (clock data*3)	Retention method	Large-capacity capacitor
	Retention time	15 days (Ambient temperature: 25°C)
Power failure retention (device)	Power failure retention capacity	Maximum 12 k words

\*1: Interrupt from the intelligent function module and high-speed pulse input/output module.

\*2: The value listed above indicates the number of files stored in the root folder.

\*3: Clock data is retained using the power accumulated in a large-capacity capacitor incorporated into the PLC. When voltage of the large-capacity capacitor drops, clock data is no longer accurately retained. The retention period of a fully charged capacitor (electricity is conducted across the PLC for at least 30 minutes) is 15 days (ambient temperature: 25°C). How long the capacitor can hold the data depends on the operating ambient temperature. When the operating ambient temperature is high, the holding period is short.

**Number of device points**

Item		Base	Max. number of points*	
No. of user device points	Input relay (X)	8	1024 points or less The total number of X and Y assigned to input/output points is up to 256 points.	
	Output relay (Y)	8		
	Internal relay (M)	10		
	Latch relay (L)	10		
	Link relay (B)	16		
	Annunciator (F)	10		
	Link special relay (SB)	16		
	Step relay (S)	10		
	Timer system	Timer (T)		10
		Accumulation timer system		10
	Counter system	Counter (C)		10
		Long counter (LC)		10
	Data register (D)	10		
	Link register (W)	16		
	Link special register (SW)	16		
No. of system device points	Special relay (SM)	10		
	Special register (SD)	10		
Module access device	Intelligent function module device	10		
No. of index register points	Index register (Z)	10		
	Long index register (LZ)	10		
No. of file register points	File register (R)	10		
	Extended file register (ER)	10		
No. of nesting points	Nesting (N)	10		
No. of pointer points	Pointer (P)	10		
	Interrupt pointer (I)	10		
Others	Decimal constant (K)	Signed	16 bits: -32768 to +32767, 32 bits: -2147483648 to +2147483647	
		Unsigned	16 bits: 0 to 65535, 32 bits: 0 to 4294967295	
	Hexadecimal constant (H)	—	16 bits: 0 to FFFF, 32 bits: 0 to FFFFFFFF	
	Real constant (E)	Single precision	—	E-3.40282347+38 to E-1.17549435-38, 0, E1.17549435-38 to E3.40282347+38
	Character string	—	—	Shift-JIS code max. 255 single-byte characters (256 including NULL) Unicode max. 255 characters (256 including NULL)*A1

\*: Maximum number of points cannot be changed. (fixed)

Models with restrictions are marked with symbols such as \*A/\*B/\*C. For details of restrictions, refer to P78 [List of annotations].

CPU Performance

Analog Control

Positioning Control

High-speed Counter Control

Network/Communication/Information-sharing

Safety Control

Programming Environment





**FX5U**

**FX5UC**

**FX5U/FX5UC CPU module performance specifications**

Item		Specification
Control system		Stored-program repetitive operation
Input/output control system		Refresh system (Direct access input/output allowed by specification of direct access input/output [DX, DY])
Programming specifications	Programming language	Ladder diagram (LD), structured text (ST), function block diagram/ladder diagram (FBD/LD), sequential function chart (SFC) <sup>*A2</sup>
	Programming expansion function	Function block (FB), function (FUN), label programming (local/global)
	Constant scan	0.2 to 2000 ms (can be set in 0.1 ms increments)
	Fixed cycle interrupt	1 to 60000 ms (can be set in 1 ms increments)
	Timer performance specifications	100 ms, 10 ms, 1 ms
	No. of program executions	32
Operation specifications	No. of FB files	16 (Up to 15 for user)
	Execution type	Standby type, initial execution type, scan execution type, fixed-cycle execution type, event execution type
Command processing time	Interrupt type	Internal timer interrupt, input interruption, high-speed comparison match interrupt, interrupt by modules <sup>*1</sup>
	LD X0	34 ns <sup>*2</sup>
Memory capacity	MOV D0 D1	34 ns <sup>*2</sup>
	Program capacity	64/128 K steps <sup>*A3</sup> (128 kbytes/256 kbytes, flash memory)
	SD memory card	Memory card capacity (SD/SDHC memory card: Max. 16 Gbytes)
	Device/label memory	150 kbytes <sup>*A6</sup>
Flash memory (Flash ROM)	Data memory/standard ROM	5 Mbytes
	write count	Maximum 20000 times
File storage capacity	Device/label memory	1
	Data memory	
	P: No. of program files FB: No. of FB files	P: 32, FB: 16
Clock function	SD memory card	NZ1MEM-2GBSD: 511 <sup>*3</sup> NZ1MEM-4GBSD, NZ1MEM-8GBSD, NZ1MEM-16GBSD: 65534 <sup>*3</sup>
	Display data	Year, month, day, hour, minute, second, day of week (leap year automatic detection)
No. of input/output points	Precision	Differences per month ±45 sec./25°C (TYP)
	(1) No. of input/output points	256 points or less/384 points or less <sup>*A4</sup>
	(2) No. of remote I/O points	384 points or less/512 points or less <sup>*A5</sup>
Power failure retention (clock data <sup>*4</sup> )	Total No. of points of (1) and (2)	512 points or less
	Retention method	Large-capacity capacitor
Power failure retention (device)	Retention time	10 days (Ambient temperature: 25°C)
	Power failure retention capacity	Maximum 12 k words <sup>*5</sup>

- \*1: Interrupt from the intelligent function module and high-speed pulse input/output module.
- \*2: When the program capacity is 64k steps.
- \*3: The value listed above indicates the number of files stored in the root folder.
- \*4: Clock data is retained using the power accumulated in a large-capacity capacitor incorporated into the PLC. When voltage of the large-capacity capacitor drops, clock data is no longer accurately retained. The retention period of a fully charged capacitor (electricity is conducted across the PLC for at least 30 minutes) is 10 days (ambient temperature: 25°C). How long the capacitor can hold the data depends on the operating ambient temperature. When the operating ambient temperature is high, the holding period is short.
- \*5: All devices in the device (high-speed) area can be held against power failure. Devices in the device (standard) area can be held also when the optional battery is mounted.

**Number of device points**

Item		Base	Max. number of points		
No. of user device points	Input relay (X)	8	1024 points or less	The total number of X and Y assigned to input/output points is up to 256 points/384 points <sup>*A4</sup> .	
	Output relay (Y)	8	1024 points or less		
	Internal relay (M)	10	32768 points (can be changed with a parameter) <sup>*1</sup>		
	Latch relay (L)	10	32768 points (can be changed with a parameter) <sup>*1</sup>		
	Link relay (B)	16	32768 points (can be changed with a parameter) <sup>*1</sup>		
	Annunciator (F)	10	32768 points (can be changed with a parameter) <sup>*1</sup>		
	Link special relay (SB)	16	32768 points (can be changed with a parameter) <sup>*1</sup>		
	Step relay (S)	10	4096 points (fixed)		
	Timer system	Timer (T)	10		1024 points (can be changed with a parameter) <sup>*1</sup>
	Accumulation timer system	Accumulation timer (ST)	10		1024 points (can be changed with a parameter) <sup>*1</sup>
	Counter system	Counter (C)	10		1024 points (can be changed with a parameter) <sup>*1</sup>
		Long counter (LC)	10		1024 points (can be changed with a parameter) <sup>*1</sup>
	Data register (D)		10		8000 points (can be changed with a parameter) <sup>*1</sup>
	Link register (W)		16		32768 points (can be changed with a parameter) <sup>*1</sup>
	Link special register (SW)		16		32768 points (can be changed with a parameter) <sup>*1</sup>
No. of system device points	Special relay (SM)	10	10000 points (fixed)		
	Special register (SD)	10	12000 points (fixed)		
Module access device	Intelligent function module device	10	65536 points (designated by U□/G□)		
No. of index register points	Index register (Z) <sup>*2</sup>	10	24 points		
	Long index register (LZ) <sup>*2</sup>	10	12 points		
No. of file register points	File register (R)	10	32768 points (can be changed with a parameter) <sup>*1</sup>		
	Extended file register (ER)	10	32768 points (are stored in SD memory card)		
No. of nesting points	Nesting (N)	10	15 points (fixed)		
	Pointer (P)	10	4096 points		
No. of pointer points	Interrupt pointer (I)	10	178 points (fixed)		
	SFC block device (BL)	10	32 points		
	SFC transition device (TR)	10	0 points (Used only as device comments.)		
Others	Decimal constant (K)	Signed	16 bits: -32768 to +32767, 32 bits: -2147483648 to +2147483647		
		Unsigned	16 bits: 0 to 65535, 32 bits: 0 to 4294967295		
	Hexadecimal constant (H)	—	16 bits: 0 to FFFF, 32 bits: 0 to FFFFFFFF		
	Real constant (E)	Single precision	E-3.40282347+38 to E-1.17549435-38, 0, E1.17549435-38 to E3.40282347+38		
	Character string	—	Shift-JIS code max. 255 single-byte characters (256 including NULL) Unicode max. 255 characters (256 including NULL) <sup>*A1</sup>		

- \*1: Can be changed with parameters within the capacity range of the CPU built-in memory.
- \*2: The sum of index register (Z) and long index register (LZ) is 24 words.

Models with restrictions are marked with symbols such as \*A/\*B/\*C. For details of restrictions, refer to P78 [List of annotations].

CPU Performance  
Analog Control  
Positioning Control  
High-speed Counter Control  
Network/Communication/Information-sharing  
Safety Control  
Programming Environment

memo



# CPU Performance

The CPU module has excellent built-in functions to respond to various types of control. In addition, an Ethernet port, SD memory card slot (FX5S is an option), etc. are mounted as standard equipment. The Ethernet port is compatible with CC-Link IE Field Network Basic and can be connected to a wide variety of equipment.

## CPU module

Screw terminal block type



Max. number of control points	Program capacity	Pulse train	Max.	Command processing time
<b>60 points</b>	<b>48 k steps</b>	<b>100 kpps</b>	<b>4 axes</b>	<b>84 ns</b>

### FX5S

Simple model

In pursuit of high basic performance and simple model selection, ease of use and simplicity are condensed into a single module.

High-speed counter function (max. 8 ch)	Positioning function (max. 4 axes)
Ethernet port	USB (Mini-B) connector

Screw terminal block type



Max. number of control points	Program capacity	Pulse train	Max.	Command processing time
<b>256 points</b>	<b>48 k steps</b>	<b>200 kpps</b>	<b>3 axes</b>	<b>34 ns</b>

### FX5UJ

High function entry model

Equipped with variety of built-in functions while demonstrating excellence in cost performance, this single module is recognized for its ease of use.

High-speed counter function (max. 8 ch)	Positioning function (max. 3 axes)
Ethernet port	USB (Mini-B) connector
SD memory card slot	

Screw terminal block type



Max. number of control points	Program capacity	Pulse train	Max.	Command processing time
<b>512* points</b>	<b>64/128 k steps</b>	<b>200 kpps</b>	<b>4 axes</b>	<b>34 ns</b>

### FX5U

High functioning all-in-one model

As an all-rounder CPU, this module can help introducing IoT to facilities and equipments in any scenes.

High-speed counter function (max. 8 ch)	Positioning function (max. 4 axes)
Ethernet port	RS-485 port
SD memory card slot	Analog input/output

Spring clamp terminal block type



Connector type



Max. number of control points	Program capacity	Pulse train	Max.	Command processing time
<b>512* points</b>	<b>64/128 k steps</b>	<b>200 kpps</b>	<b>4 axes</b>	<b>34 ns</b>

### FX5UC

High function compact model

Compact housing helps save space in panels. A lineup of spring clamp terminal blocks has also been added.

High-speed counter function (max. 8 ch)	Positioning function (max. 4 axes)
Ethernet port	RS-485 port
SD memory card slot	

\*: Max. number of control points, including remote I/O points.

Models with restrictions are marked with symbols such as \*A/\*B/\*C. For details of restrictions, refer to P78 [List of annotations].

CPU Performance  
Analog Control  
Positioning Control  
High-speed Counter Control  
Network/Communication/Information-sharing  
Safety Control  
Programming Environment

## Built-in interface

### Built-in Ethernet port

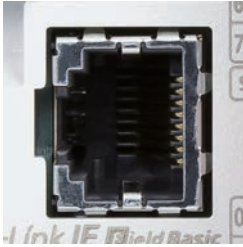

- The Ethernet port can handle communication with up to 8 connections on the network.
- It also supports CC-Link IE Field Network Basic.



Ethernet communication function	Number of connectable stations/modules	
	FX5S/FX5UJ	FX5U/FX5UC
MELSOFT connection*1	Up to 8 stations in total	Up to 8 stations in total
SLMP		
Predefined protocol support		
Socket communication		
MODBUS/TCP communication (Master station/slave station)*2		
CC-Link IE Field Network Basic*2	8 stations	16 stations
Simple CPU communication function*2	8 modules	16 modules
File transfer function*2	FTP server*3	Total 1 modules
	FTP client*3	
Time setting function (SNTP client)*2	1 modules	1 modules
Web server*2	System Web page	Up to 4 modules in total
	User Web page*3	
Real-time monitoring function*2	1 modules	1 modules

### Built-in SD memory card slot (FX5S is an option)



- The built-in SD memory card slot is convenient for updating programs and mass producing products.

### Built-in RS-485 port (with MODBUS/RTU communication)



FX5U FX5UC

- Built-in RS-485 port allows for communication with inverters, etc.
- MODBUS/RTU communication is also supported. It can connect to MODBUS compatible devices such as PLCs and temperature controllers.

### RUN/STOP/RESET switch



- Equipped with a RUN/STOP/RESET switch, the device can be rebooted without turning off the main power for debugging.

### Built-in USB (Mini-B) connector

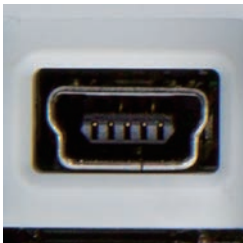

FX5S FX5UJ

- A USB (Mini-B) connector for programming interface is provided as standard.

### Built-in analog input/output (with alarm output)



FX5U

- The FX5U has built-in 12-bit 2 ch analog voltage input and 1 ch analog voltage output.

\*1: One MELSOFT connection is not included in the number of connections. (The second and subsequent modules are included.)

\*2: A firmware upgrade may be required to use some functions and modules. For details, refer to appendix P77 [Function compatibility table].

\*3: The FX5S CPU module requires the optional SD memory card module (FX5-SDCC).

Models with restrictions are marked with symbols such as \*A/\*B/\*C. For details of restrictions, refer to P78 [List of annotations].



## ▶ Program area is securely set aside

### Memory area for each application

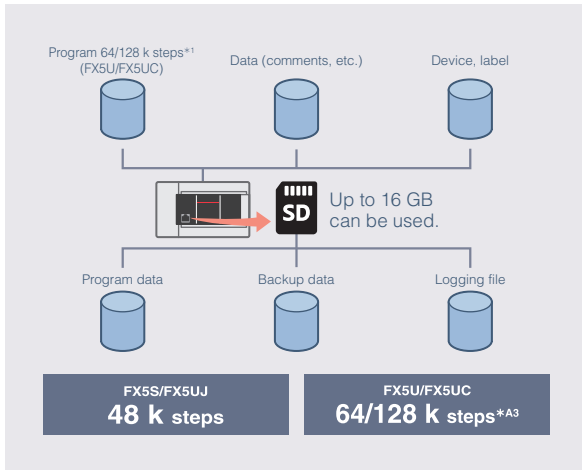

- Data areas of memory are reserved for each application.
- Can write programs without worrying about memory for comments, etc.  
[Maximum number of characters]  
Comments: 1024 characters  
Statements: 5000 characters

## ▶ Firmware can be upgraded

### Firmware update function

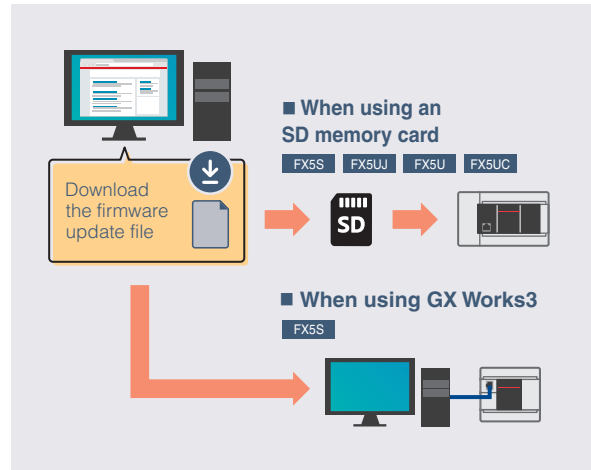

- The firmware version can be upgraded without replacing the CPU module in use.
- Provide update files free of charge\*3.

## ▶ Device values can be saved when an error occurs

### Memory dump function\*1\*2

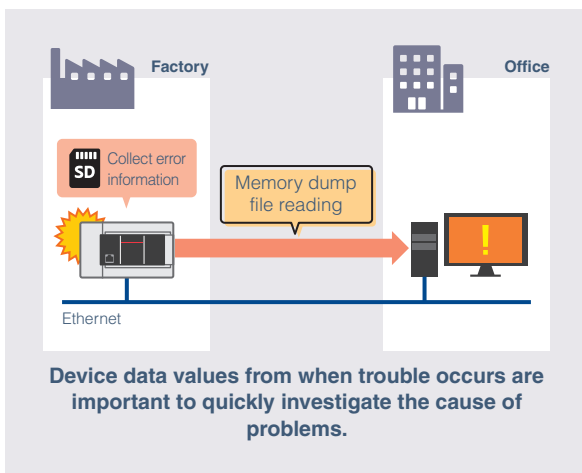

- Device values can be saved in a batch to an SD memory card when an error occurs.
- Saved data can be checked on the program editor.
- This provides powerful support for troubleshooting when errors occur.

## ▶ Possible to collect data before and after trouble occurs

### Data logging function\*1\*2

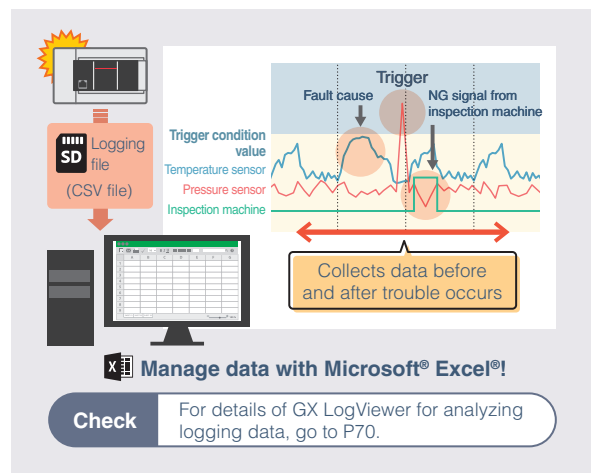

- Logging data can be easily collected without the need for programming.
- CSV file\*/binary file format output is available.
- Supports debugging and analysis of equipment.
- Utilizing logging data also helps introduce traceability.



Can be supported by CPU modules



SD memory card required (FX5S requires a separate SD memory card module)

\*1: A firmware upgrade may be required to use some functions and modules. For details, refer to appendix P77 [Function compatibility table].

\*2: The data logging function and memory dump function cannot be used simultaneously.

\*3: Please contact your local Mitsubishi Electric sales office or representative.

Models with restrictions are marked with symbols such as \*A/\*B/\*C. For details of restrictions, refer to P78 [List of annotations].

➤ **Back up data in case of an emergency**

Backup/restore function\*1 [Device/label data\*2, data memory\*2]  + 

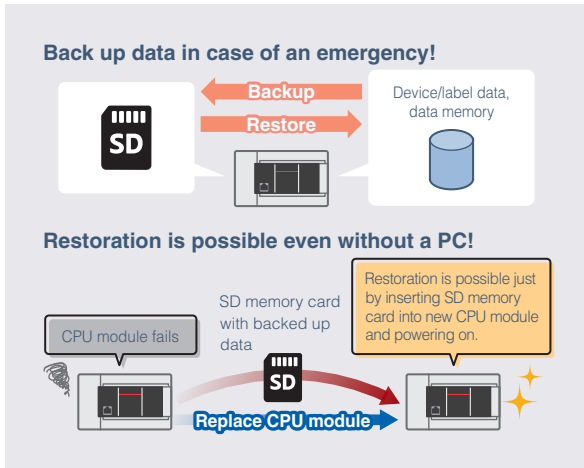

- Data can be backed up/restored at any time.
- If data memory is backed up to an SD memory card, the device can be restored when the CPU module is turned ON.
- If the CPU module fails, it can recover promptly without a PC.

➤ **Allows for batch collection of logs from distant factories**

File transfer function [FTP server\*2/FTP client\*2]  + 

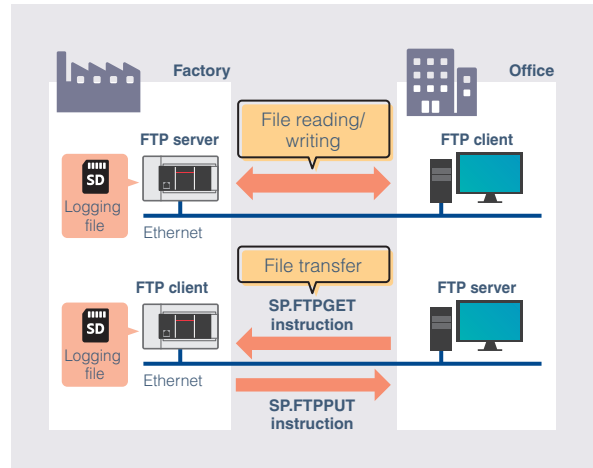

- Using the file transfer function instruction, you can transfer logging files, etc., and obtain data from the server without complicated settings and operations in the upper system (FTP server).

➤ **Reduces changeover time and improves production efficiency on small production lines with multiple products**

File transfer function\*2 [FTP client file acquisition] (SP.FTPGET)  + 

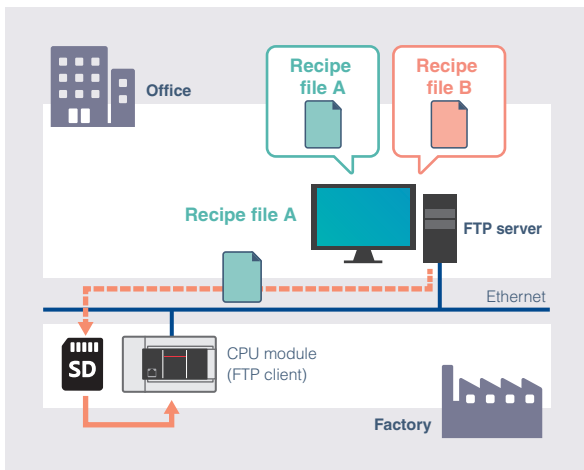

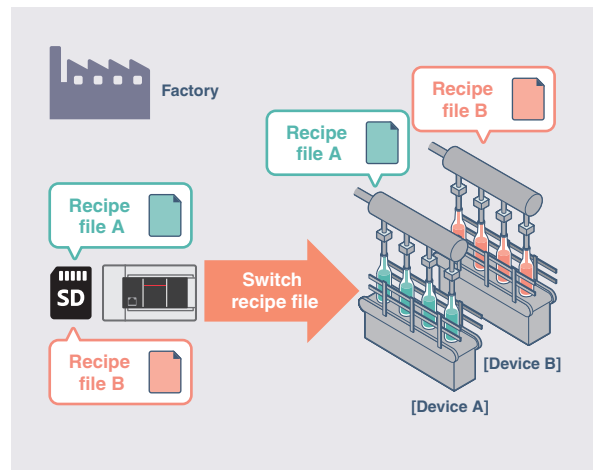

- Recipe files can be acquired in the SD memory card by connecting to an FTP server.
- Simply enable the FTP client function and add the program to acquire the recipe file.

File operation instructions\*2 [Data read from a specified file (SP.FREAD)]  + 



- Multiple recipe files on an SD memory card can be switched to read values into the device.
- Automatic switching of recipe data is possible, reducing setup loss time.

 Can be supported by CPU modules  SD memory card required (FX5S requires a separate SD memory card module)

\*1: While the backup/restore function is executed, some functions are temporarily unavailable. For details, refer to the manual.  
 \*2: A firmware upgrade may be required to use some functions and modules. For details, refer to appendix P77 [Function compatibility table].  
 \*3: Excluding the buffer memory of the intelligent function module.

Models with restrictions are marked with symbols such as \*A/\*B/\*C. For details of restrictions, refer to P78 [List of annotations].

CPU Performance  
Analog Control  
Positioning Control  
High-speed Counter Control  
Network/Communication/Information-sharing  
Safety Control  
Programming Environment

## ▶ Device status can be checked from a smartphone or tablet

Web server function\*1

System Web page

User Web page

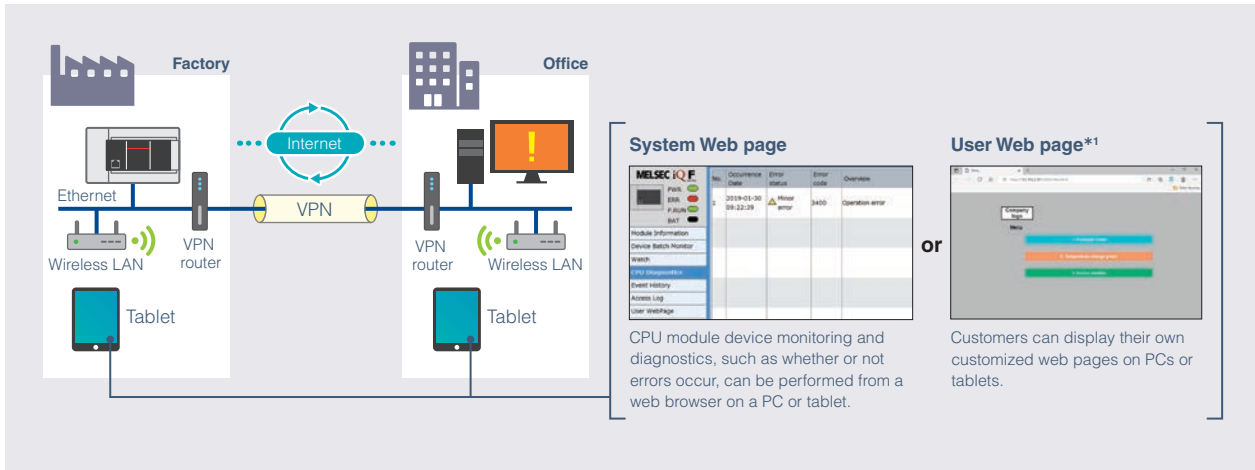

- No program needed. An easy diagnosis just by accessing PLC!
- Even without a PC or engineering tools, the status can easily be checked with a smartphone or tablet.
- Simple diagnosis provides sufficient preparation prior to on-site surveys for efficient maintenance.

## User Web page drawing tool

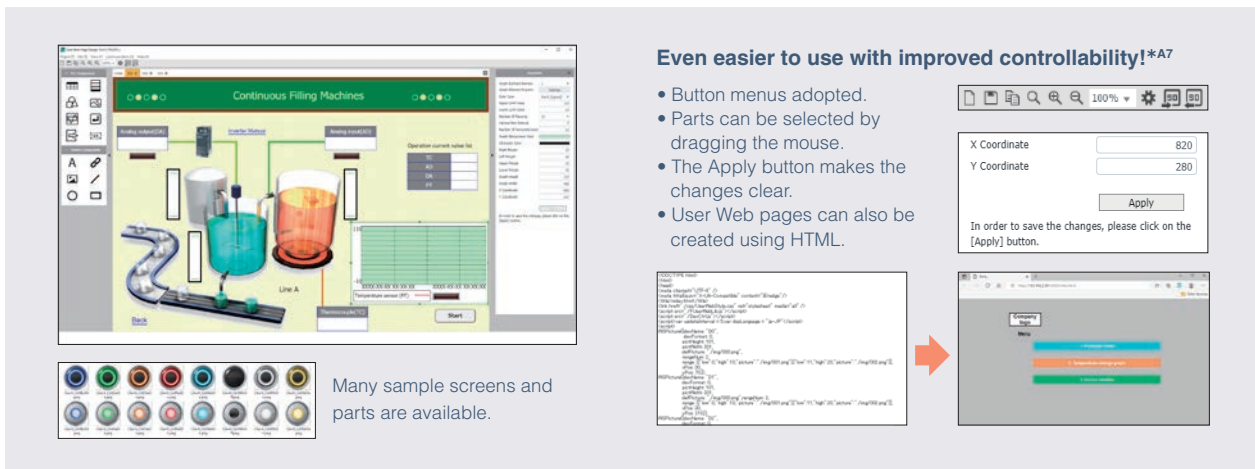

- User Web pages can be created in two ways, with a drawing tool or with HTML.
- With the user Web page drawing tool, Web pages can be created by combining sample screens and parts.



Can be supported by CPU modules



SD memory card required (FX5S requires a separate SD memory card module)

\*1: A firmware upgrade may be required to use some functions and modules. For details, refer to appendix P77 [Function compatibility table].

Models with restrictions are marked with symbols such as \*A/\*B/\*C. For details of restrictions, refer to P78 [List of annotations].

## Prevents customers' programs from leaking

### Security key authentication function

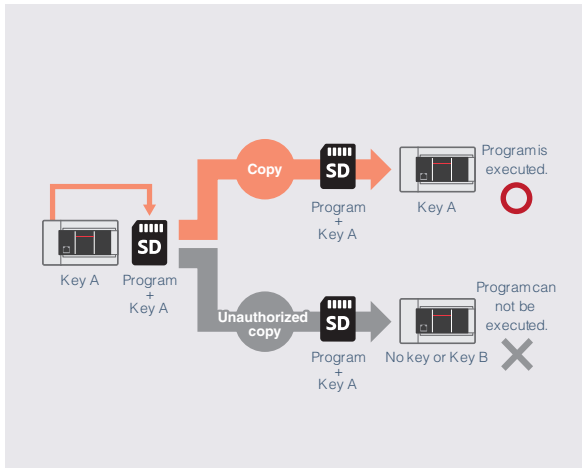

- Prevents data theft, tampering, misoperation, and illegal execution, etc. caused by unauthorized access from third parties.
- Programs cannot be executed on a CPU module without a registered security key, preventing program leakage.

## Prevents unauthorized access via network

### IP filter function\*1

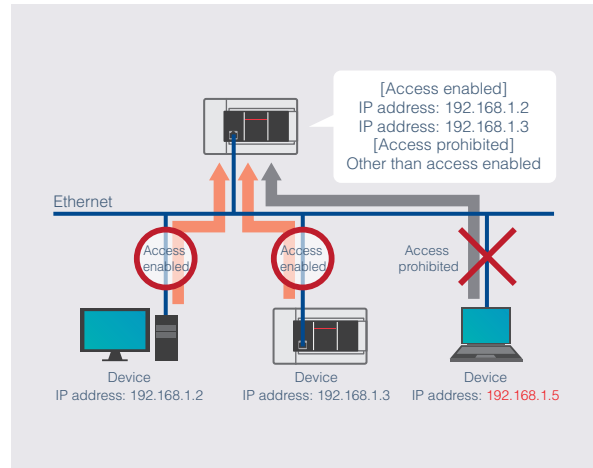

- Prevents access from devices other than authorized devices by registering the IP addresses of devices that can access the CPU module.
- Reduces the risk of unauthorized hacking or data tampering by third parties.

## Possible to send and receive device data without programs

### Simple CPU communication function\*1

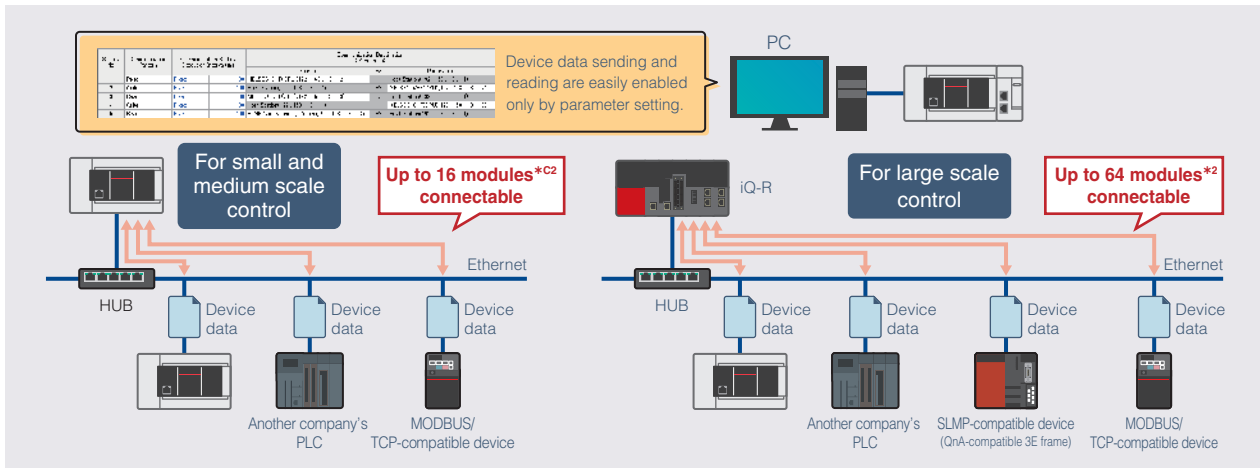

- Using a simple parameter setting with GX Works3 as the master, device data such as production data can be transferred without a program.
- The CPU module can easily perform communication with existing systems that use the MELSEC iQ-R series, Q series, L series, FX3 series, or another company's PLC.



Can be supported by CPU modules



SD memory card required (FX5S requires a separate SD memory card module)

\*1: A firmware upgrade may be required to use some functions and modules. For details, refer to appendix P77 [Function compatibility table].

\*2: When using the iQ-R CPU module's built-in Ethernet port.

Models with restrictions are marked with symbols such as \*A/\*B/\*C. For details of restrictions, refer to P78 [List of annotations].



➤ **Operation of Ethernet-equipped modules can be monitored**

**SLMP communication**

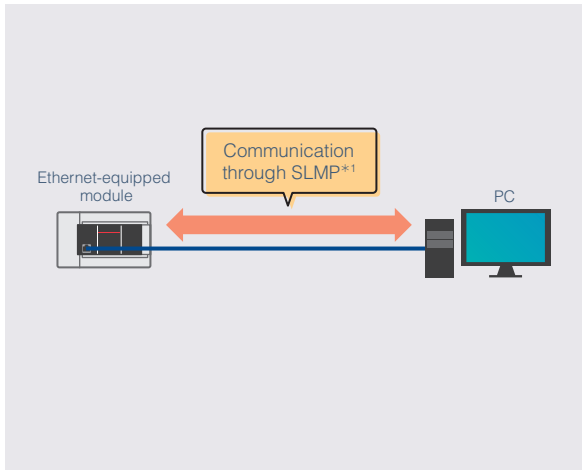

- Seamless communication like a single network using a common protocol, SLMP\*1(3E/1E\*2 frame). Information can be easily collected and equipment monitored and maintained from anywhere in the office or at worksites.

➤ **Possible to send and receive data to/from the PC**

**Socket communication**

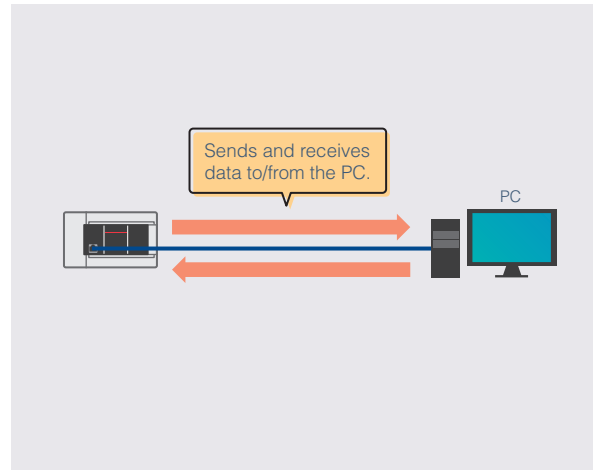

- Data communication with Ethernet-connected devices is possible via TCP or UDP.

➤ **Troubleshooting can even be performed remotely**

**Remote maintenance**

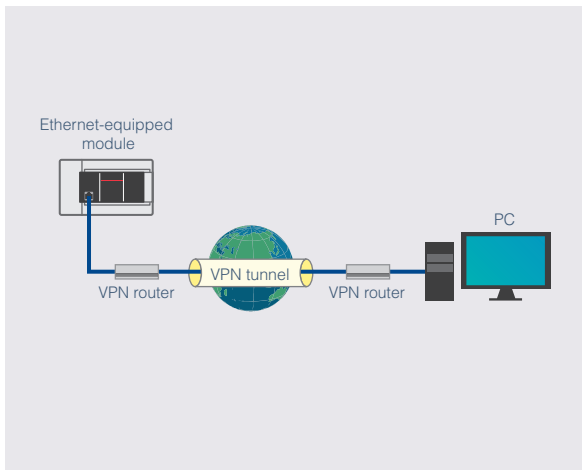

- GX Works3 can be connected via VPN, and programs can be read/written.
- Troubleshooting can be performed from a remote place, which leads to a reduction in maintenance costs.

\*1: SeamLess Message Protocol

\*2: A firmware upgrade may be required to use some functions and modules. For details, refer to appendix P77 [Function compatibility table].

Models with restrictions are marked with symbols such as \*A/\*B/\*C. For details of restrictions, refer to P78 [List of annotations].

## SD memory card module (option)

**NEW** FX5-SDCD **FX5S**



- **Required when using SD memory card with FX5S CPU module**



- SD memory card module enables expansion of IoT functions (data collection, remote monitoring, etc.).
- SD memory cards are available. For details, refer to P15.

- **Can be used with expansion boards**

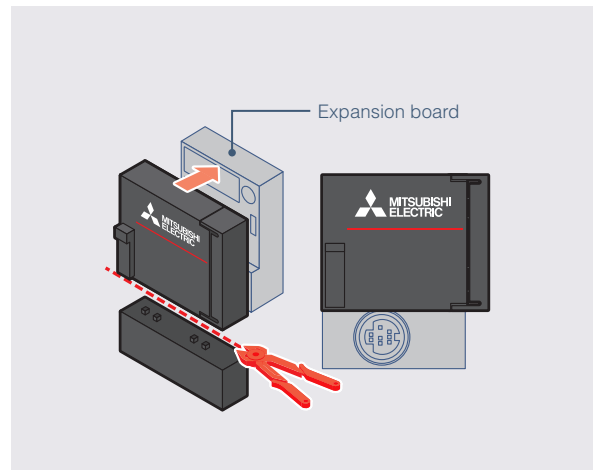

- The cover can be cut off and attached to the upper section of other expansion boards.

## Spring clamp terminal block used in many modules

- **Spring clamp advantages**

- Spring force holds wires in place, preventing wires from falling out due to vibration.
- There is no need for crimp terminals or crimp tools. Wiring is possible without extra time or cost.
- No external terminal block is needed. Easily detachable & securely fixed by a lock lever.

For ferrule terminals of FX5UC CPU module, the following is introduced.

(Reference product: PHOENIX CONTACT GmbH & Co. KG\*)

Model	Type	
CRIMPFOX 6	Crimp tool	
AI 0.5-10 WH	Crimp terminal (Ferrule with insulation sleeve)	Wire size 0.5 mm <sup>2</sup>
AI 0.75-10 GY	Crimp terminal (Ferrule with insulation sleeve)	Wire size 0.75 mm <sup>2</sup>
A 1.0-10	Crimp terminal (Ferrule without insulation sleeve)	Wire size 1.0 mm <sup>2</sup>
A 1.5-10	Crimp terminal (Ferrule without insulation sleeve)	Wire size 1.5 mm <sup>2</sup>

### <Internal construction>

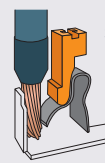

Securely fixed by elastic force!

With detachable terminal blocks, the change of wiring is not needed even when replacing the modules!



### Wiring is complete in 3 steps

Easy wiring by simply plugging in a twist.

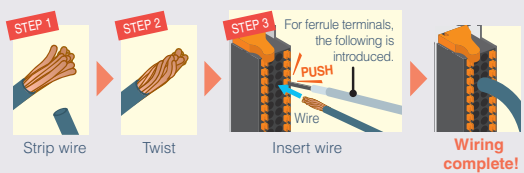

**With ferrule terminal blocks, you don't even need a precision screwdriver!**

\*: If a product other than the reference product is used, the wire ferrule cannot be pulled out. Sufficiently Confirm that the wire ferrule can be pulled out before use.

Models with restrictions are marked with symbols such as \*A/\*B/\*C. For details of restrictions, refer to P78 [List of annotations].

## List of Built-in Functions by CPU Module

✓: Supported, △: Partially supported, —: Not supported

Function	Content	CPU module**1			
		FX5S	FX5UJ	FX5U	FX5UC
Data collecting function					
Data logging function	Collects data at the specified interval or any desired timing, and stores them as a file on the SD memory card.	△*2	✓	✓	✓
Memory dump function	Saves the data in the devices of the CPU module at a desired timing.	△*2	✓	✓	✓
Communication function					
Built-in Ethernet function	An Ethernet related function such as connection to MELSOFT products and GÖTs, socket communication, file transfer function (FTP server, FTP client), Web server (HTTP), SNMP client, and simple CPU communication function. For details, refer to P52 [General-purpose Ethernet].	✓	✓	✓	✓
CC-Link IE Field Network Basic function	Exchanges data between the master station and remote station using general-purpose Ethernet.	✓	✓	✓	✓
Serial communication function	A function related to the serial communication such as N:N Network, parallel link, MC protocol, inverter communication function and non-protocol communication.	✓*3	✓*3	✓	✓
MODBUS communication function	Connection with the products which support MODBUS RTU/TCP is available. The master and slave functions can be used.	✓	✓	✓	✓
High-speed input/output function					
High-speed counter function	Performs high-speed counter, pulse width measurement, input interruption, etc. by using the input of the CPU module or high-speed pulse input/output module.	✓	✓	✓	✓
Positioning function	Executes positioning operation by using the transistor output of the CPU module or high-speed pulse input/output module.	✓	✓	✓	✓
Analog function					
Analog input function	Voltage input/output can be performed with analog input and analog output.	—	—	✓	—
Analog output function		—	—	✓	—
Feedback control					
PID control function	PID control commands provide feedback control for analog changes in temperature, pressure, water volume, etc.	✓	✓	✓	✓
PID control via parameter function	Performs PID control (standard PID control, heating-cooling PID control) by using GX Works3 parameters.	—	—	✓	✓
Security functions					
Security functions	Protects resources stored in PCs and resources in the units in the system of the FX5 from illegal access by a third party such as theft, alteration, accidental operation and unauthorized execution.	✓	✓	✓	✓
IP filter function	Identifies the IP address of external devices over Ethernet, and blocks access from an invalid IP address.	✓	✓	✓	✓
Maintenance function					
Firmware update function	Updates the firmware of the module. Only FX5S can be updated with firmware from GX Works3 without an SD memory card.	✓*2	✓	✓	✓
Scan monitoring function (watch dog timer setting)	Detects an error in the hardware and program of the CPU module by monitoring the scan time.	✓	✓	✓	✓
Memory card function	Boot operation	△*2	✓	✓	✓
Real-time monitoring function	Monitors the data in the specified device of the CPU module at a specified interval or at a desired timing in real time.	✓	✓	✓	✓
RAS function	Event history function	✓	✓	✓	✓
Data backup/restoration function	Backs up program files, parameter files, and device/label data files in a CPU module to an SD memory card. The backup data can be restored as needed.	△*2	✓	✓	✓
Program function					
Constant scan	Keeps the scan time constant and executes program repeatedly.	✓	✓	✓	✓
Initial device value setting	Sets the initial values of devices used in the program directly (not via the program) to the devices.	✓	✓	✓	✓

\*1: A firmware upgrade may be required to use some functions and modules. For details, refer to appendix P77 [Function compatibility table].  
 \*2: Requires the optional SD memory card module (FX5-SDCD).  
 \*3: A communication board or communication adapter is required.

Models with restrictions are marked with symbols such as \*A/\*B/\*C. For details of restrictions, refer to P78 [List of annotations].

memo





# Analog Control

Using analog input and output devices, operations such as input and output of analog quantities (voltage, current, etc.), temperature input and adjustment, etc. can be performed.

Use the ample lineup of extension modules for analog control that matches your applications.

## List of models

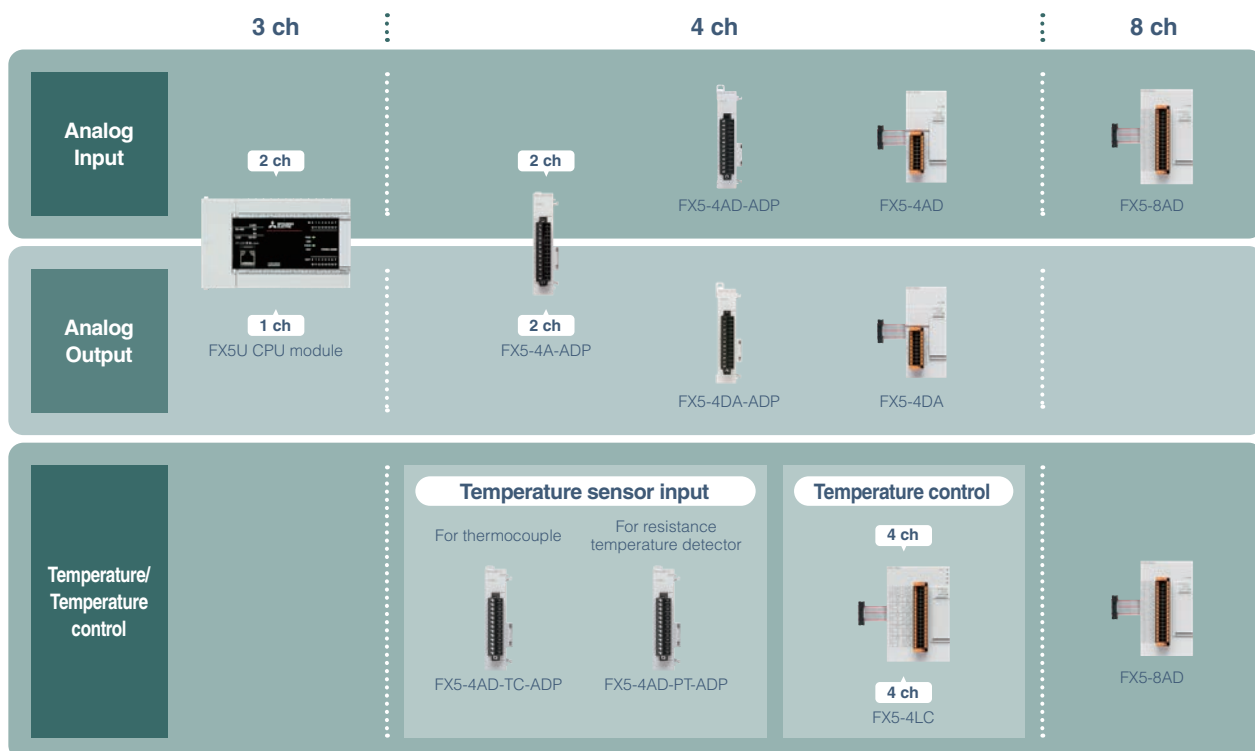

## Analog functions built into the FX5U CPU module

FX5U CPU module



### ▶ Analog input/output supported on the module itself

**Analog functions built into the CPU module help downsizing equipment!**

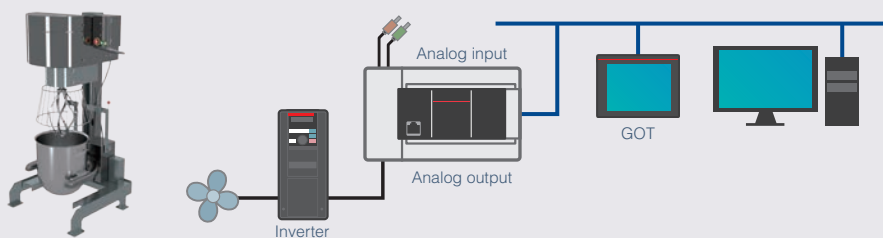

- With built-in 12-bit 2 ch analog voltage input and 1 ch analog voltage output.
- No programming is required, just parameter setting. Reduce programming man-hours.
- Equipped with an alarm output function. When the value enters the alarm output range, an alarm output.

Models with restrictions are marked with symbols such as \*A/\*B/\*C. For details of restrictions, refer to P78 [List of annotations].

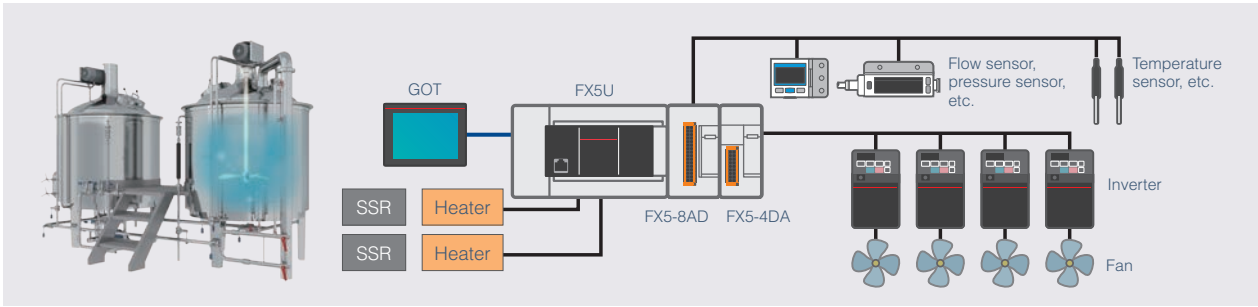

## Analog input

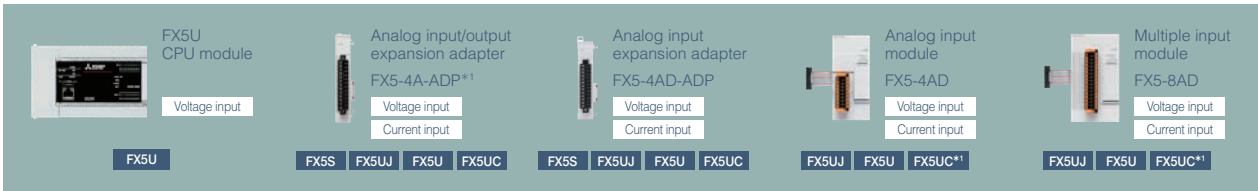

### Additional equipment can be added to suit any application

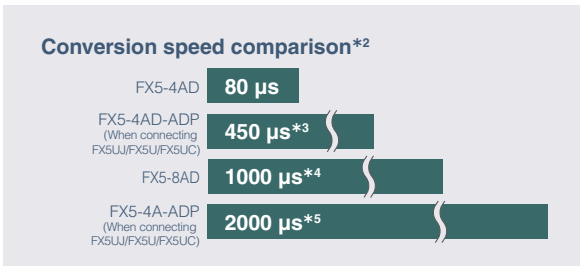

- Additional equipment can be added according to the application (equipment requirements).

### Capable of monitoring equipment status

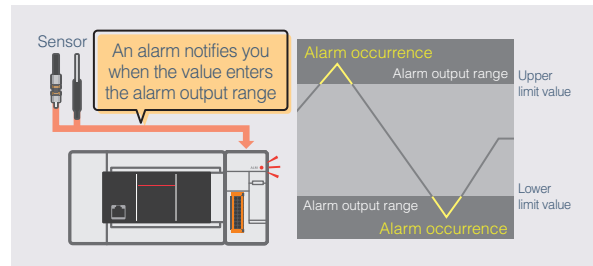

- Supports input signal abnormality detection and alarm output functions.
- Easily monitor the status of connected devices.

## Analog output

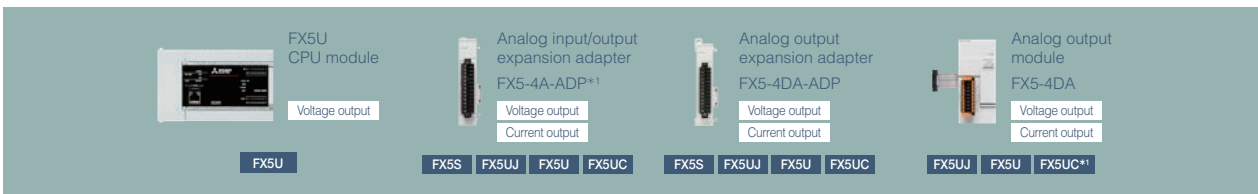

### With the FX5-4DA, the waveform output function achieves smooth waveform output

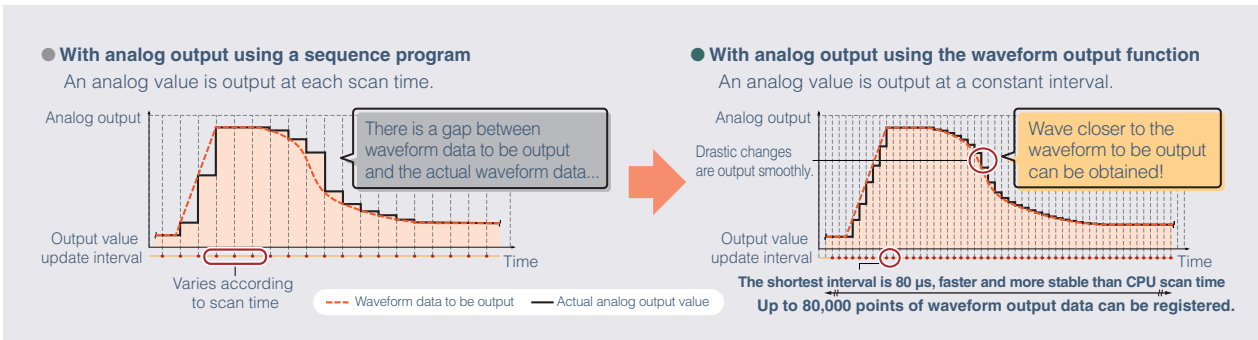

- The operator can update analog output values in the D/A conversion cycle without depending on the scan time.
- The operator can register waveform output data in the analog output module, and repeatedly use it.

\*1: Depending on the CPU module, system configuration, serial number, etc., the type and number of connectable modules may differ, or separate equipment may be required for connection. For details, please refer to Chapter 1 Lineup Details and Model Selection or use the FA Integrated Selection Tool.

\*2: The conversion speed of the expansion adapter varies according to scan time.  
 \*3: 500  $\mu$ s when connecting FX5S.  
 \*4: 1000  $\mu$ s/2 ch for 2CH conversion mode.  
 \*5: 2200  $\mu$ s when connecting FX5S.

Models with restrictions are marked with symbols such as \*A/\*B/\*C. For details of restrictions, refer to P78 [List of annotations].

## Temperature input

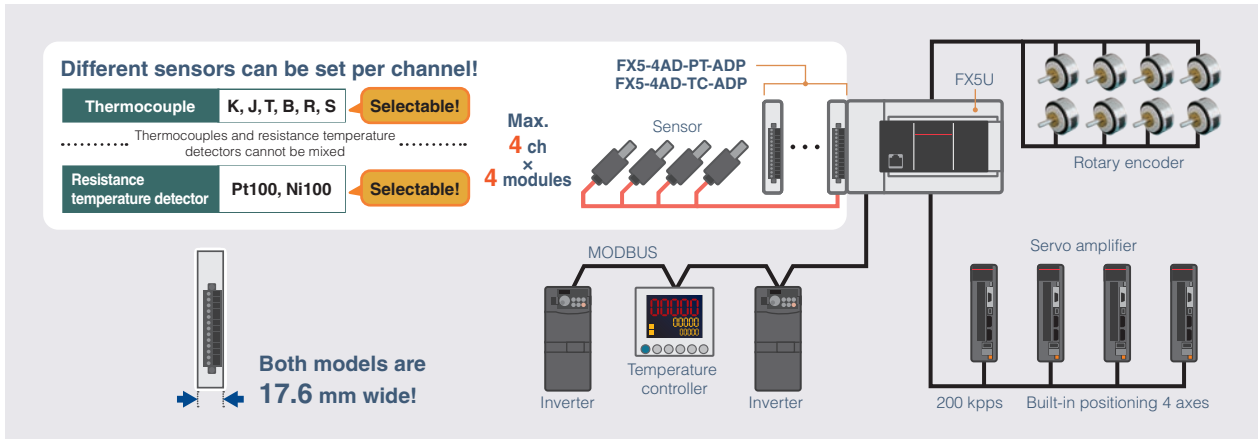
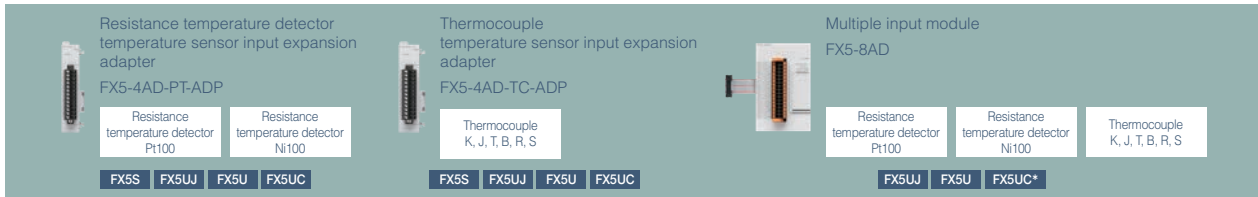

- Compatible with resistance temperature detectors (Pt100, Ni100) and temperature sensors.
- Capable of measuring 4 channels with a resolution of 0.1°C.

## Multiple input

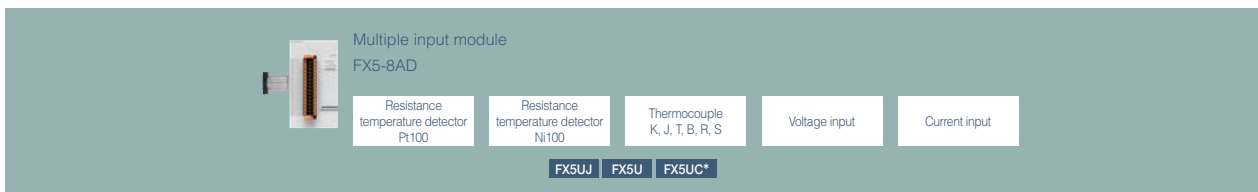

➤ **Various applications can be handled by this single module**

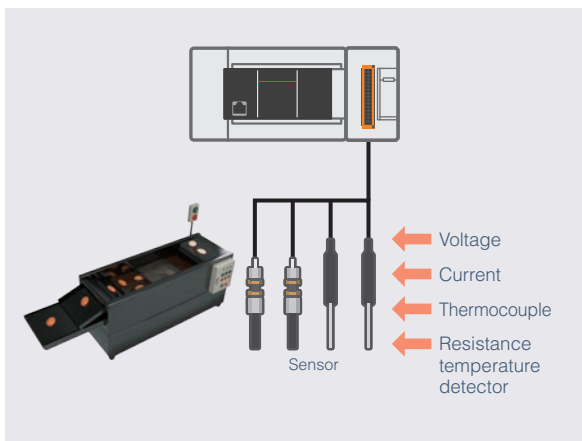

- Input type can be set per channel.
- Uses a spring clamp terminal block.

➤ **Immediate response to disconnection**

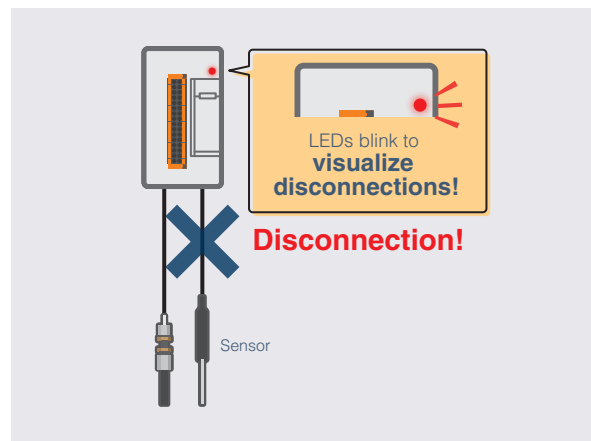

- Thermocouple and resistance temperature detector disconnection can be easily detected.
- Downtime due to disconnection can be reduced.

\*: Depending on the CPU module, system configuration, serial number, etc., the type and number of connectable modules may differ, or separate equipment may be required for connection. For details, please refer to Chapter 1 Lineup Details and Model Selection or use the FA Integrated Selection Tool.

Models with restrictions are marked with symbols such as \*A/\*B/\*C. For details of restrictions, refer to P78 [List of annotations].

## Temperature control

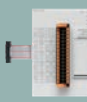

Temperature control module  
FX5-4LC

Resistance temperature detector 3-wire Pt100	Resistance temperature detector 3-wire JPt100	Resistance temperature detector 2-wire/3-wire Pt1000	Thermocouple K, J, T, B, R, S, N JIS C 1602-1995, PLII, W5Re/W26Re, U, L	Micro voltage input
---	--	---	--	---------------------

FX5UJ FX5U FX5UC\*

### ➤ 4 channel temperature control is possible

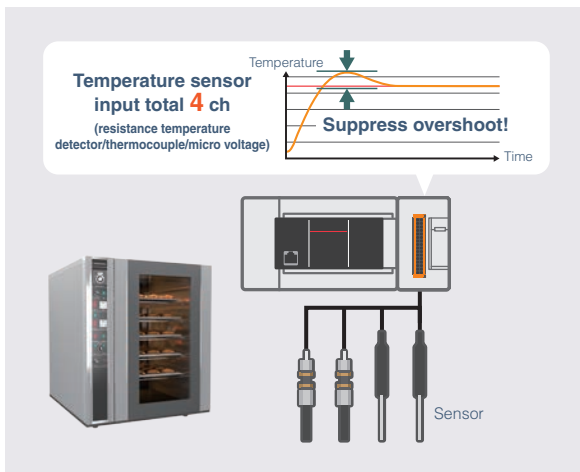

**Temperature sensor input total 4 ch**  
(resistance temperature detector/thermocouple/micro voltage)

Temperature

Time

Suppress overshoot!

Sensor

- Input type can be set per channel.
- Supports PID control and suppress overshoot.

### ➤ Visible changes in food temperature [Temperature trace]

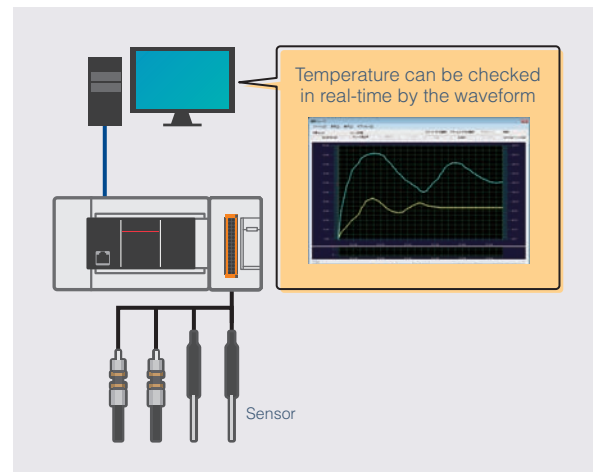

Temperature can be checked in real-time by the waveform

Sensor

- Temperature changes can be checked using a waveform.
- Parameters can be adjusted while checking the displayed temperature waveform.

\*: Depending on the CPU module, system configuration, serial number, etc., the type and number of connectable modules may differ, or separate equipment may be required for connection. For details, please refer to Chapter 1 Lineup Details and Model Selection or use the FA Integrated Selection Tool.

Models with restrictions are marked with symbols such as \*A/\*B/\*C. For details of restrictions, refer to P78 [List of annotations].

## Performance comparison table

### Analog input (voltage, current) specification

✓: Supported, —: Not supported

Analog device		Specification				Applicable CPU module			
		Analog input	Input resistance value	Input property (varies according to input range)		FX5S	FX5UJ	FX5U	FX5UC
				Digital output value	Maximum resolution				
FX5U CPU module (built-in)	Voltage	0 to 10 V DC	115.7 kΩ	0 to 4000	2.5 mV	—	—	✓	—
	Current*1	4 to 20 mA DC	—	400 to 2000	10 μA	—	—	—	—
FX5-4A-ADP	Voltage	-10 to +10 V DC	1 MΩ	0 to 16000 (0 to 5 V)	312.5 μV	✓	✓	✓	✓
	Current	-20 to +20 mA DC	250 Ω	0 to 16000 (0 to 20 mA)	1.25 μA	—	—	—	—
FX5-4AD-ADP	Voltage	-10 to +10 V DC	1 MΩ	0 to 16000 (0 to 5 V)	312.5 μV	✓	✓	✓	✓
	Current	-20 to +20 mA DC	250 Ω	0 to 16000 (0 to 20 mA)	1.25 μA	—	—	—	—
FX5-4AD	Voltage	-10 to +10 V DC	400 kΩ or more	-32000 to +32000 (user range setting)	125 μV	—	✓	✓	✓
	Current	-20 to +20 mA DC	250 Ω	-32000 to +32000 (user range setting)	500 nA	—	—	—	—
FX5-8AD	Voltage	-10 to +10 V DC	1 MΩ	-32000 to +32000 (-10 to +10 V)	312.5 μV	—	✓	✓	✓
	Current	-20 to +20 mA DC	250 Ω	-32000 to +32000 (-20 to +20 mA)	625 nA	—	—	—	—
FX3U-4AD	Voltage	-10 to +10 V DC	200 kΩ	-32000 to +32000 (-10 to +10 V)	0.32 mV	—	—	✓	✓
	Current	-20 to +20 mA DC, 4 to 20 mA DC	250 Ω	-20000 to +20000 (-20 to +20 mA)	1.25 μA	—	—	—	—

### Analog output (voltage, current) specification

✓: Supported, —: Not supported

Analog device		Specification				Applicable CPU module			
		Analog output	External load resistance value	Output property (varies according to output range)		FX5S	FX5UJ	FX5U	FX5UC
				Digital output value	Maximum resolution				
FX5U CPU module (built-in)	Voltage	0 to 10 V DC	2 k to 1 MΩ	0 to 4000	2.5 mV	—	—	✓	—
	Current	—	—	—	—	—	—	—	—
FX5-4A-ADP	Voltage	-10 to +10 V DC	1 k to 1 MΩ	0 to 16000 (1 to 5 V)	250 μV	✓	✓	✓	✓
	Current	0 to 20 mA DC	0 to 500 Ω	0 to 16000 (4 to 20 mA)	1 μA	—	—	—	—
FX5-4DA-ADP	Voltage	-10 to +10 V DC	1 k to 1 MΩ	0 to 16000 (1 to 5 V)	250 μV	✓	✓	✓	✓
	Current	0 to 20 mA DC	0 to 500 Ω	0 to 16000 (4 to 20 mA)	1 μA	—	—	—	—
FX5-4DA	Voltage	-10 to +10 V DC	1 k to 1 MΩ	-32000 to +32000 (user range setting)	312.5 μV	—	✓	✓	✓
	Current	0 to 20 mA DC	0 to 500 Ω	-32000 to +32000 (user range setting)	500 nA	—	—	—	—
FX3U-4DA	Voltage	-10 to +10 V DC	1 k to 1 MΩ	-32000 to +32000 (-10 to +10 V)	0.32 mV	—	—	✓	✓
	Current	0 to 20 mA DC, 4 to 20 mA DC	500 Ω or less	0 to 32000 (0 to 20 mA)	0.63 μA	—	—	—	—

### Temperature sensor input specification (resistance temperature detector Pt100)

✓: Supported, —: Not supported

Analog device	Specification				Applicable CPU module			
	Analog input value		Analog output value		FX5S	FX5UJ	FX5U	FX5UC
	Measuring temperature range (degrees Celsius (°C)) <sup>*2</sup>	Precision (ambient temperature 25 ± 5°C)	Digital output value	Resolution				
FX5-4AD-PT-ADP	-200 to +850°C	±0.8°C	-2000 to +8500	0.1°C	✓	✓	✓	✓
FX5-8AD	-200 to +850°C	±0.8°C	-2000 to +8500	0.1°C	—	✓	✓	✓
FX5-4LC	-200 to +600°C	■ Input range: Less than 200°C ±0.6°C ± 1 digit ■ Input range: 200°C or more ±(0.3% of display value) ± 1 digit	—	0.1°C, 1.0°C <sup>*3</sup>	—	✓	✓	✓
FX3U-4LC	-50.0 to +150.0°C, -200.0 to +600.0°C	■ Input range: Less than 200°C ±0.6°C ± 1 digit ■ Input range: 200°C or more ±(0.3% of display value) ± 1 digit	—	0.1°C, 1.0°C <sup>*3</sup>	—	—	✓	✓

### Temperature sensor input specification (thermocouple K)

✓: Supported, —: Not supported

Analog device	Specification				Applicable CPU module			
	Analog input value		Analog output value		FX5S	FX5UJ	FX5U	FX5UC
	Measuring temperature range (degrees Celsius (°C)) <sup>*2</sup>	Precision (ambient temperature 25 ± 5°C)	Digital output value	Resolution				
FX5-4AD-TC-ADP	-200 to +1200°C	±3.7°C (-100 to +1200°C) <sup>*4</sup> , ±4.9°C (-150 to -100°C) <sup>*4</sup> , ±7.2°C (-200 to -150°C) <sup>*4</sup>	-2000 to +12000	0.1°C	✓	✓	✓	✓
FX5-8AD	-200 to +1200°C	±3.5°C (-200 to -150°C), ±2.5°C (-150 to -100°C), ±1.5°C (-100 to +1200°C)	-2000 to +12000	0.1°C	—	✓	✓	✓
FX5-4LC	-200 to +1300°C	■ Input range: Less than -100°C ±3.0°C ± 1 digit ■ Input range: -100 to less than +500°C ±1.5°C ± 1 digit ■ Input range: 500°C or more ±(0.3% of display value) ± 1 digit	—	0.1°C, 1.0°C <sup>*3</sup>	—	✓	✓	✓
FX3U-4LC	-200.0 to +200.0°C, -100.0 to +400.0°C, -100 to +1300°C	■ Input range: Less than -100°C ±3.0°C ± 1 digit ■ Input range: -100 to less than +500°C ±1.5°C ± 1 digit ■ Input range: 500°C or more ±(0.3% of display value) ± 1 digit	—	0.1°C, 1.0°C <sup>*3</sup>	—	—	✓	✓

\*1: By connecting a 250 Ω resistor (0.5% precision resistance) between the V+ and V- terminals, the analog input of the built-in analog can be used with current input (4 to 20 mA DC).

\*2: For Fahrenheit (°F), refer to Chapter 4 Analog Control.

\*3: Varies according to the input range of the sensor in use.

\*4: Accuracy varies according to the measuring temperature range in the parentheses ( ).

Models with restrictions are marked with symbols such as \*A/\*B/\*C. For details of restrictions, refer to P78 [List of annotations].

## Micro voltage input specification

✓: Supported, —: Not supported

Analog device	Micro voltage input	Specification			Resolution	Applicable CPU module			
		Precision				FX5S	FX5UJ	FX5U	FX5UC
		25 ± 5°C ambient temperature	0 to 55°C ambient temperature	-20 to 0°C ambient temperature					
FX5-4LC	0 to 10 mV DC, 0 to 100 mV DC	±(0.3% of span) ±1 digit	±(0.7% of span) ±1 digit	±(0.9% of span) ±1 digit	0.5 μV, 5.0 μV*1	—	✓	✓	✓
FX3U-4LC	0 to 10 mV DC, 0 to 100 mV DC	±(0.3% of span) ±1 digit	±(0.7% of span) ±1 digit	—	0.5 μV, 5.0 μV*1	—	—	✓	✓

## Analog device function compatibility table

✓: Supported, —: Not supported

Specification	Analog device										
	Input/output mixing		Input			Output		Input	Temperature sensor input		Temperature control
	FX5U CPU Module (built-in)	FX5-4A-ADP	FX5-4AD-ADP	FX5-4AD	FX5-4DA-ADP	FX5-4DA	FX5-8AD		FX5-4AD-TC-ADP	FX5-4AD-PT-ADP	
Range switching function	—	✓	✓	✓	✓	✓	✓	✓	✓	✓	—
Conversion enable/disable setting function	✓	✓	✓	✓	✓	✓	✓	✓	✓	✓	—
Conversion method	✓	✓	✓	✓	—	—	✓	✓	✓	✓	—
Analog output HOLD/CLEAR function	✓	✓	—	—	✓	✓	—	—	—	—	—
Analog Output Test when CPU Module is in STOP Status Function	✓	✓	—	—	✓	✓	—	—	—	—	—
Over scale detection function	✓	✓	✓	—	—	—	—	—	—	—	—
Scaling function	✓	✓	✓	✓	✓	✓	✓	—	—	—	—
Shift function	✓	✓	✓	✓	✓	✓	✓	—	—	—	—
Digital clipping function	✓	✓	✓	✓	—	—	✓	—	—	—	—
Maximum value/minimum value hold function	✓	✓	✓	✓	—	—	✓	✓	✓	—	—
Warning output function	✓	✓	✓	✓	✓	✓	✓	✓	✓	—	—
Rate control function	—	—	—	—	—	✓	—	—	—	—	—
Input signal error detection function	—	—	—	✓	—	—	✓	—	—	—	—
External power supply disconnection detection function	—	✓	—	—	✓	✓	—	—	—	—	—
Disconnection detection function	—	✓	✓	—	✓	✓	✓	✓	✓	—	—
Convergence detection function	—	✓	✓	—	—	—	—	—	—	—	—
Deviation detection between channel function	—	✓	✓	—	—	—	—	—	—	—	—
Logging function	—	—	—	✓	—	—	✓	—	—	—	—
Logging read function	—	—	—	✓	—	—	—	—	—	—	—
Interrupt function	—	—	—	✓	—	✓	—	—	—	—	—
Error history function	—	—	—	✓	—	—	✓	—	—	—	✓
Wave output function	—	—	—	—	—	✓	—	—	—	—	—
Event history function	✓	✓	—	—	✓	—	—	✓	✓	—	—
Offset/gain setting function	—	✓	✓	✓	✓	✓	—	✓	✓	—	—
Offset/gain initialization function	—	✓	✓	✓	✓	—	—	✓	✓	—	—
2CH conversion mode function	—	—	—	—	—	—	✓	—	—	—	—

\*1: Varies according to the input range of the sensor in use.

\*2: For details on the functions that can be used with temperature control modules, refer to the manual.

Models with restrictions are marked with symbols such as \*A/\*B/\*C. For details of restrictions, refer to P78 [List of annotations].





# Positioning Control

The CPU module has a built-in positioning function. Complex multi-axis and interpolation control can be performed using the positioning module and simple motion module.

## List of models

	2 axes	3 axes	4 axes	8 axes
CPU Performance	<b>CPU module (built-in positioning), high-speed pulse input/output module</b>  FX5-16ET/ES-H, FX5-20ET/ESS-H Simple linear interpolation (start 2 axes simultaneously)	 FX5UJ CPU module (transistor output type only)	 FX5S/FX5U/FX5UC CPU module (transistor output type only) Simple linear interpolation (start 2 axes simultaneously)	
Analog Control	<b>Positioning module</b> <b>Pulse train</b>  FX5-20PG-P, FX5-20PG-D Linear interpolation, circular interpolation	<b>Simple motion module</b>  FX5-40SSC-S, FX5-80SSC-S • Linear interpolation, circular interpolation • Synchronous control, cam control, torque control		
Positioning Control				
High-speed Counter Control				
Network/Communication/Information-sharing				
Safety Control				
Programming Environment				

## Built-in positioning

FX5S/FX5UJ/FX5U/FX5UC CPU module

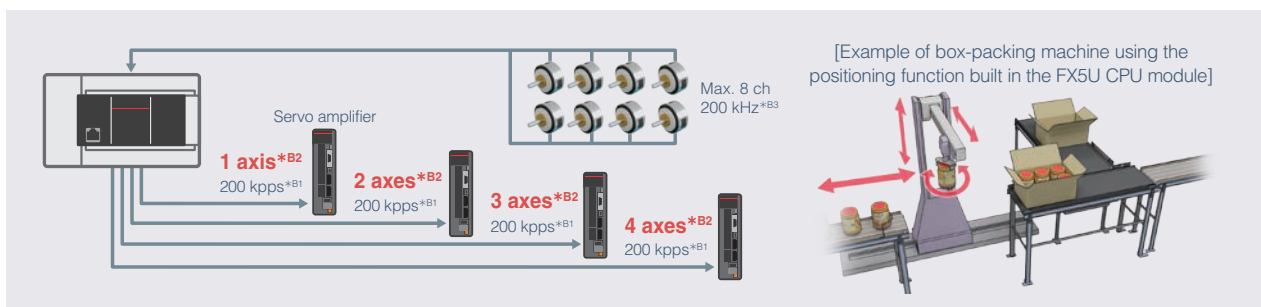

- Positioning function is built into CPU module (transistor output type only).
- Allows for building systems at low cost with only a single CPU module.

Models with restrictions are marked with symbols such as \*A/\*B/\*C. For details of restrictions, refer to P78 [List of annotations].

## Positioning module (high-speed pulse input/output module extension)

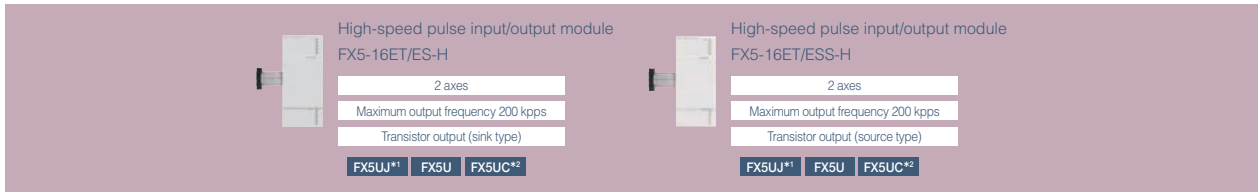

### ► Possible to add the number of axes available for the positioning function

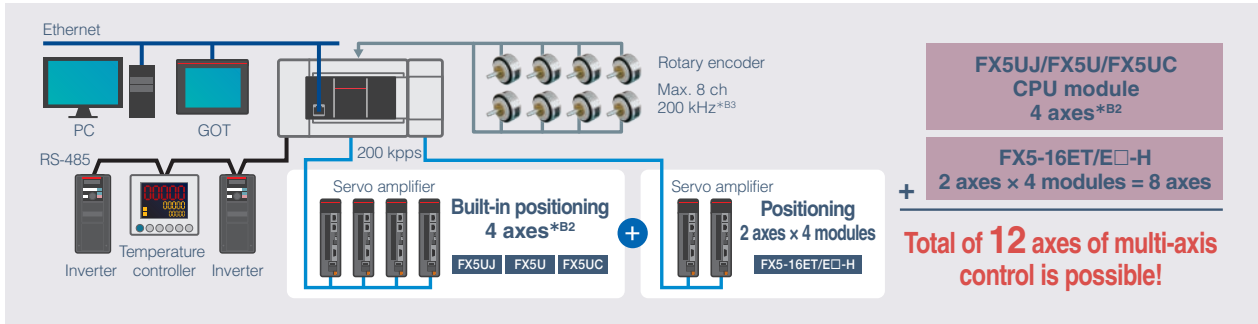

- Further multi-axis control is possible by adding to the FX5UJ/FX5U/FX5UC CPU module.

## Positioning module

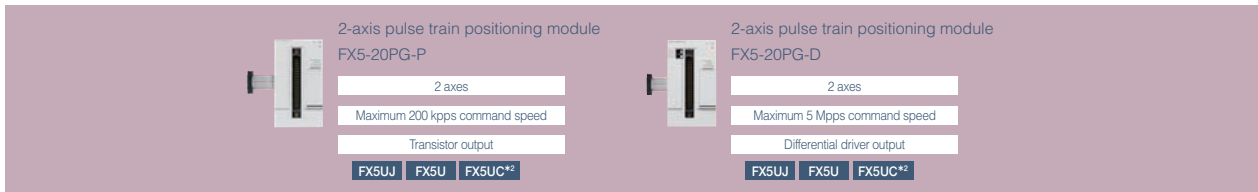

### ► S-curve acceleration/deceleration allows for transfer of products without tipping them over

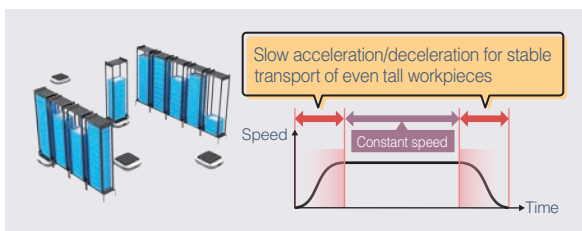

- Acceleration/deceleration processing can be selected from two methods, trapezoidal and S-curve acceleration/deceleration, and four types of acceleration and deceleration times can be set for each.

### ► Allows for high-speed starts

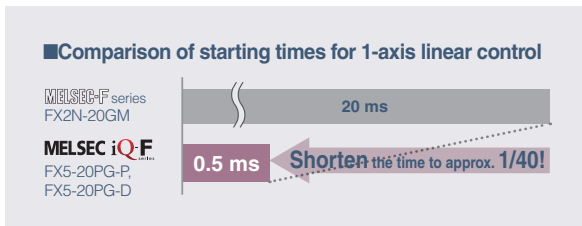

- The high-speed normal positioning starting process speed can shorten the starting time to 0.5 ms.

### ► The maximum pulse output is 5 Mpps, and the connection distance is 10 m\*3

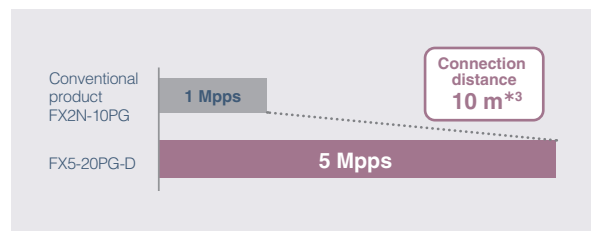

- With maximum output pulses of 5 Mpps for the FX5-20PG-D, control is possible for devices with higher resolutions than conventional products.
- The maximum connection distance between servos is 10 m\*3.

### ► Quick start function supported

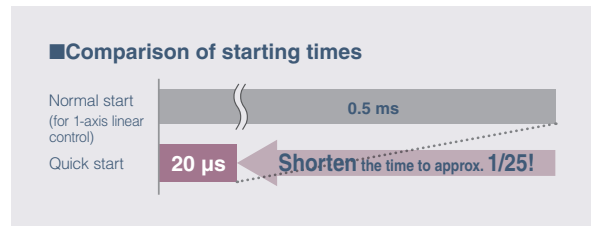

- By analyzing positioning data in advance, positioning can be started at a high-speed of maximum 20 μs.

\*1: The availability of the connection depends on the version of the CPU module. For details, please refer to Chapter 1 Lineup Details and Model Selection or use the FA Integrated Selection Tool.

\*2: Depending on the CPU module, system configuration, serial number, etc., the type and number of connectable modules may differ, or separate equipment may be required for connection. For details, please refer to Chapter 1 Lineup Details and Model Selection or use the FA Integrated Selection Tool.

\*3: For FX5-20PG-P, the maximum pulse output is 200 kpps, and the connection distance is 2 m.

Models with restrictions are marked with symbols such as \*A/\*B/\*C. For details of restrictions, refer to P78 [List of annotations].

## Motion control

CC-Link IE TSN



### System configuration example (for FX5-80SSC-G)

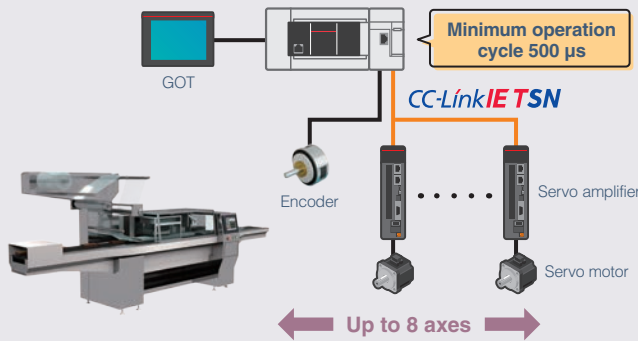

#### Main functions

- Linear interpolation
- Circular interpolation
- Continuous path control
- S-curve acceleration/deceleration

#### Application examples

- Packaging equipment
- Printing equipment
- Material processing equipment

#### List of applicable motion modules

Supported network	Number of connectable module	Number of connectable module
CC-Link IE TSN	FX5S/FX5UJ not supported	FX5U up to 4 modules*
Number of connectable module	Supported servo amplifier	
FX5UC up to 4 modules*	MELSERVO-J5	

- By using a motion module and the high-performance servo amplifier MELSERVO-J5 series, advanced positioning control can be supported.
- Simple motion module programs can be used. This reduces programming man-hours.

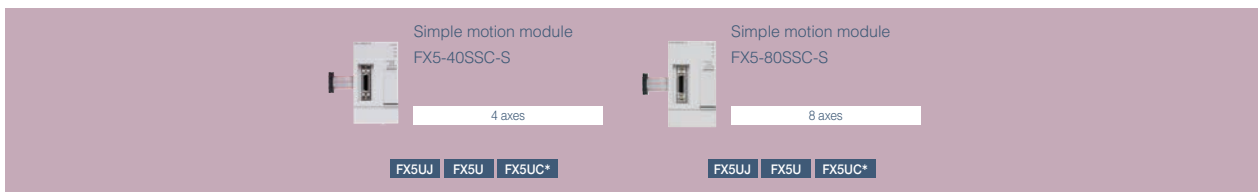

### System configuration example (for FX5-80SSC-S)

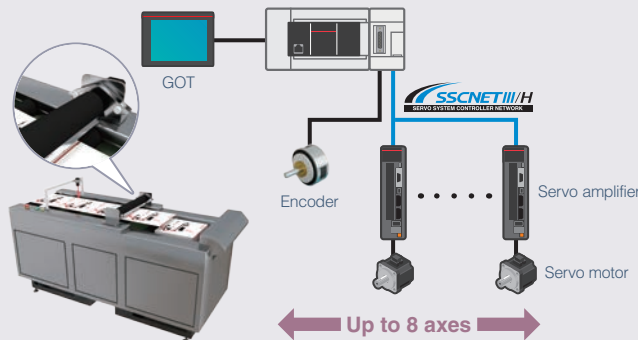

#### Main functions

- Linear interpolation
- Circular interpolation
- Continuous path control
- S-curve acceleration/deceleration

#### Application examples

- Sealing system
- Palletizer
- Grinding system

#### List of applicable motion modules

Supported network	Number of connectable module	Number of connectable module
SSCNET III/H	FX5S not supported	FX5UJ up to 1 module
Number of connectable module	Number of connectable module	Supported servo amplifier
FX5U up to 16 modules	FX5UC up to 15 modules	MELSERVO-J4

- It can be used for various purposes by combining linear interpolation, 2-axis circular interpolation, constant quantity feed, and continuous path control in a point table-based program.

\*: Depending on the CPU module, system configuration, serial number, etc., the type and number of connectable modules may differ, or separate equipment may be required for connection. For details, please refer to Chapter 1 Lineup Details and Model Selection or use the FA Integrated Selection Tool.

Models with restrictions are marked with symbols such as \*A/\*B/\*C. For details of restrictions, refer to P78 [List of annotations].

## ➤ Synchronous operation enables extra controls

### Synchronous control

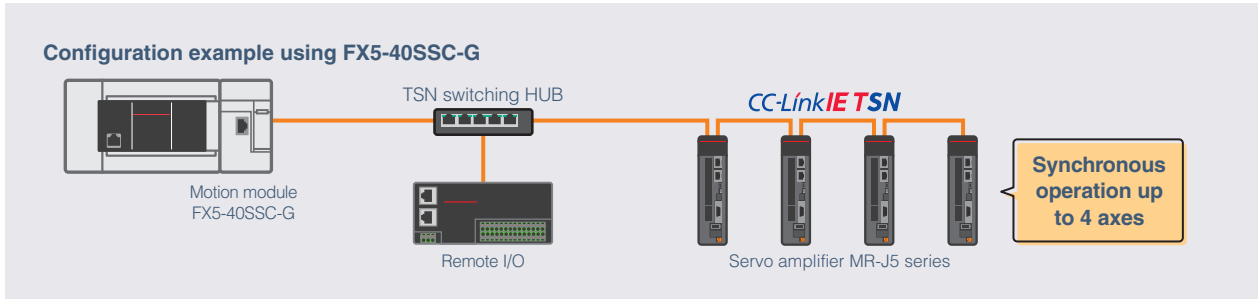

- Synchronous control and cam control can be used to build a system perfect for your equipment.
- Up to 128 types\*<sup>B4</sup> of cam data can be registered to respond quickly to any type of contents (fillings).
- Continuous operation can be performed without stopping the workpiece.

## ➤ Capable of reading/cutting fast moving register marks

### Mark detection function

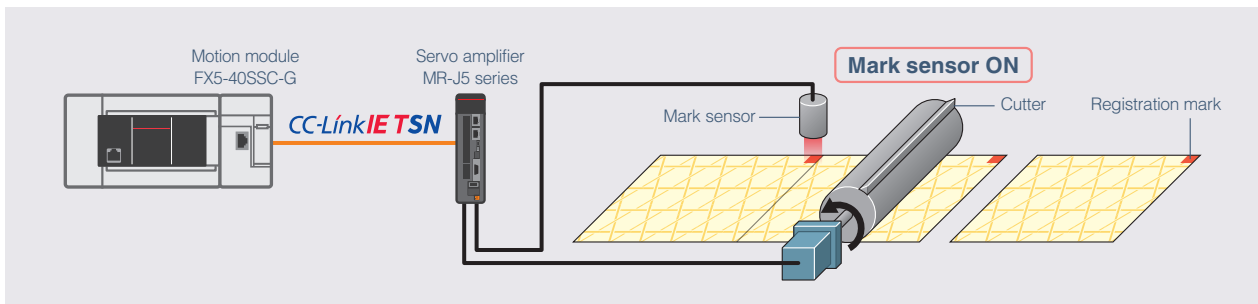

- The real current position of the servo motor can be obtained by reading the register marks on the wrapping paper when it is moving at high speed.
- By compensating for misalignment of the cutter axis when register marks are input, wrapping paper can be cut at a constant position.

## ➤ Easy creation of cam data with auto-generation

### Cam data auto-generation

User-created GOT screen

Parameter settings, including items like sheet length, etc.

**Cam data**

Item	FX5-40SSC-G/ FX5-80SSC-G	FX5-40SSC-S	FX5-80SSC-S	
Memory capacity	Cam save area	128 k bytes	64 k bytes	128 k bytes
	Cam load area	1024 k bytes	1024 k bytes	
Max. number of registrations*	Cam save area	Up to 128	Up to 64	Up to 128
	Cam load area	Up to 256		Up to 256

- Cam data can be automatically generated simply by inputting sheet length, synchronization width, and cam resolution, etc.
- Saving the cam data in the cam save area enables use of the last cam data even after power-off.
- The larger the memory capacity, the greater the variety of settings can be used. The larger the memory capacity, the finer the position control.

\*: The maximum number of registered cams varies depending on the memory capacity, cam resolution, and the number of coordinates.

Models with restrictions are marked with symbols such as \*A/\*B/\*C. For details of restrictions, refer to P78 [List of annotations].

## CC-Link IE Field Network Basic connection

### Easy FX5 and MELSERVO connection

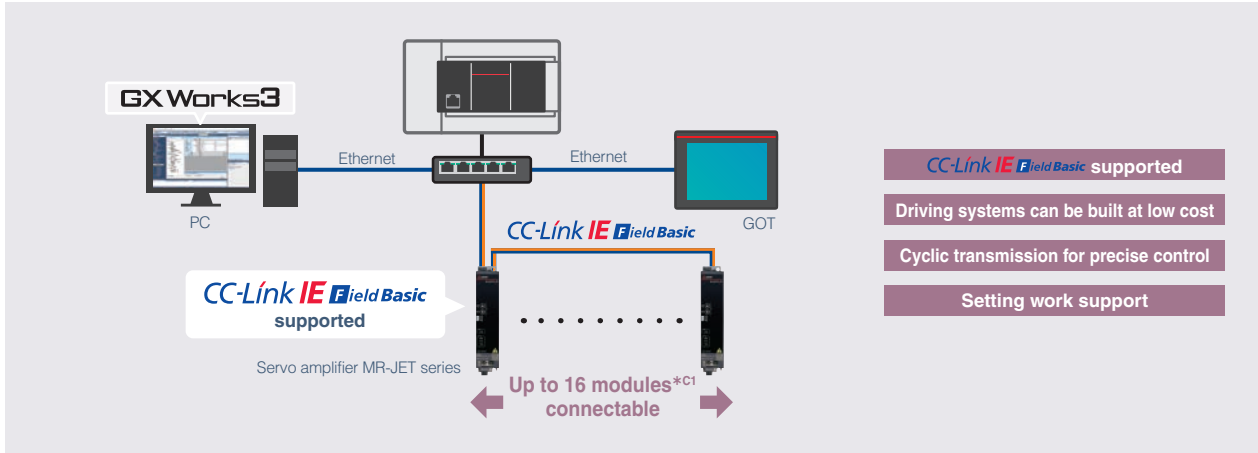

- CPU module and MELSERVO-JET can be connected by CC-Link IE Field Network Basic.
- Free sample programs are available.
- An easy-to-follow connection guide helps you understand the setup procedure at a glance.

### FB compatible with PLCopen® reduces programming man-hour

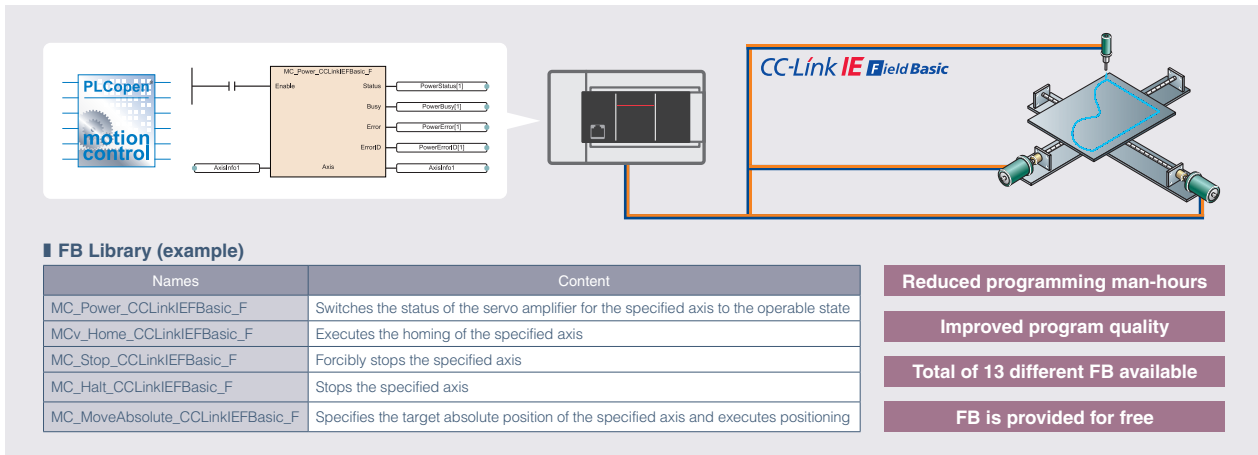

#### FB Library (example)

Names	Content
MC_Power_CCLinkIEFBasic_F	Switches the status of the servo amplifier for the specified axis to the operable state
MCv_Home_CCLinkIEFBasic_F	Executes the homing of the specified axis
MC_Stop_CCLinkIEFBasic_F	Forcibly stops the specified axis
MC_Halt_CCLinkIEFBasic_F	Stops the specified axis
MC_MoveAbsolute_CCLinkIEFBasic_F	Specifies the target absolute position of the specified axis and executes positioning

- Programming can be done using the PLCopen® Motion Control FB library, an international standard.
- From the logged data, GX LogViewer can analyze the operation status, which improves the efficiency of debugging.
- FB makes it easier for third parties to utilize data.

Models with restrictions are marked with symbols such as \*A/\*B/\*C. For details of restrictions, refer to P78 [List of annotations].

## Electric actuator connection

### Support tools make actuator setup easy

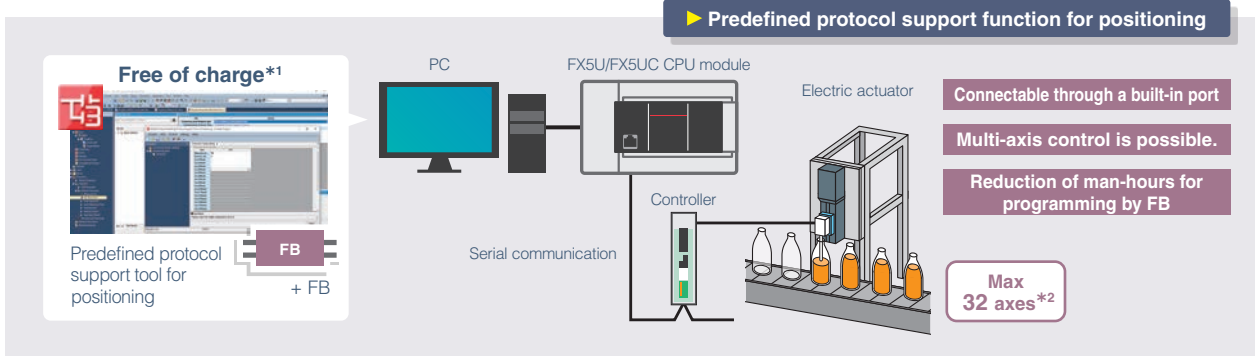

- “Predefined protocol support tool for positioning” and “Predefined protocol support FBs for positioning” are provided for free.
- Programming man-hours can be reduced by using the support tools or FB.

### Support tools and FB can facilitate fine-tuning in case of trouble

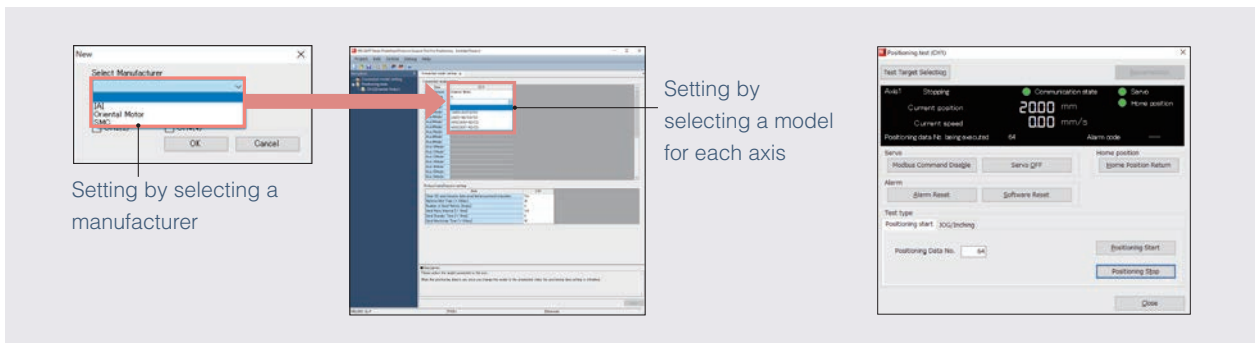

- A communication protocol can be set only by selecting the model.
- You can adjust the positioning operation connected by each manufacturer while monitoring the operation of the electric actuator.

## Comparison of positioning control-related product specifications

✓: Supported, —: Not supported

Category	Product model	Positioning system	Max. number of axes	Linear interpolation	Circular interpolation	Synchronous control
CPU module built-in positioning	FX5S CPU module	Pulse train (transistor output)	4 axes × 100 kpps	✓	—	—
	FX5UJ CPU module	Pulse train (transistor output)	3 axes × 200 kpps	—	—	—
	FX5U/FX5UC CPU module	Pulse train (transistor output)	4 axes × 200 kpps	✓	—	—
High-speed pulse input/output module	FX5-16ET/ES-H	Pulse train (transistor output)	2 axes × 200 kpps	✓	—	—
	FX5-16ET/ESS-H	Pulse train (transistor output)	2 axes × 200 kpps	✓	—	—
Positioning module	FX5-20PG-P	Pulse train (transistor output)	2 axes × 200 kpps	✓	✓	—
	FX5-20PG-D	Pulse train (differential driver output)	2 axes × 5 Mpps	✓	✓	—
Motion module	FX5-40SSC-G	Network (CC-Link IE TSN)	4 axes	✓	✓	✓
	FX5-80SSC-G	Network (CC-Link IE TSN)	8 axes	✓	✓	✓
Simple motion module	FX5-40SSC-S	Network (SSCNET III/H)	4 axes	✓	—	✓
	FX5-80SSC-S	Network (SSCNET III/H)	8 axes	✓	✓	✓
Ethernet	FX5S CPU module	Network (CC-Link IE Field Network Basic)	8 axes	—	—	—
	FX5UJ CPU module	Network (CC-Link IE Field Network Basic)	8 axes	—	—	—
	FX5U/FX5UC CPU module	Network (CC-Link IE Field Network Basic)	16 axes	—	—	—
	FX5-ENET	Network (CC-Link IE Field Network Basic)	32 axes	—	—	—
Serial communication	FX5U/FX5UC CPU module	Network (RS-485)	32 axes	—	—	—
	FX5-485-BD	Network (RS-485)	32 axes	—	—	—
	FX5-485ADP	Network (RS-485)	32 axes	—	—	—

\*1: Please contact your local Mitsubishi Electric sales office or representative.  
\*2: In the case of SMC Corporation.

Models with restrictions are marked with symbols such as \*A/\*B/\*C. For details of restrictions, refer to P78 [List of annotations].









# High-speed Counter Control

The high-performance, high-speed counter built-in the CPU module allows for high-speed control with simple programs. Channels can be added using high-speed pulse I/O modules.

## List of models

		Number of channels	Input format/input voltage	Type/max. frequency
CPU Performance	<b>CPU module (built-in high-speed counter)</b>  FX5S/FX5UJ CPU module	Max. 8 ch 1-phase 1-input 100 kHz : 4 ch 10 kHz : 4 ch	Open collector 24 V DC	1-phase 1-input : 100 kHz* 1-phase 2-input : 100 kHz* 2-phase 2-input [1 edge count] : 100 kHz* 2-phase 2-input [2 edge count] : 50 kHz* 2-phase 2-input [4 edge count] : 25 kHz*
Analog Control	<b>CPU module (built-in high-speed counter)</b>  FX5U/FX5UC CPU module	Max. 8 ch FX5U-32M□/FX5UC-32M□ 1-phase 1-input 200 kHz : 6 ch 10 kHz : 2 ch	Open collector 24 V DC	1-phase 1-input : 200 kHz* 1-phase 2-input : 200 kHz* 2-phase 2-input [1 edge count] : 200 kHz* 2-phase 2-input [2 edge count] : 100 kHz* 2-phase 2-input [4 edge count] : 50 kHz*
Positioning Control	<b>High-speed pulse input/output module</b>  FX5-16ET/ES-H, FX5-16ET/ESS-H	Max. 2 ch	Open collector 24 V DC	1-phase 1-input : 200 kHz 1-phase 2-input : 200 kHz 2-phase 2-input [1 edge count] : 200 kHz 2-phase 2-input [2 edge count] : 100 kHz 2-phase 2-input [4 edge count] : 50 kHz
High-speed Counter Control	<b>High-speed counter block</b>  FX3U-2HC	Max. 2 ch	Open collector 5 V/12 V/24 V DC Differential line driver 5 V DC	1-phase 1-input : 200 kHz 1-phase 2-input : 200 kHz 2-phase 2-input [1 edge count] : 200 kHz 2-phase 2-input [2 edge count] : 100 kHz 2-phase 2-input [4 edge count] : 50 kHz

## CPU module equipped with high-speed counter function

FX5S/FX5UJ/FX5U/FX5UC CPU module

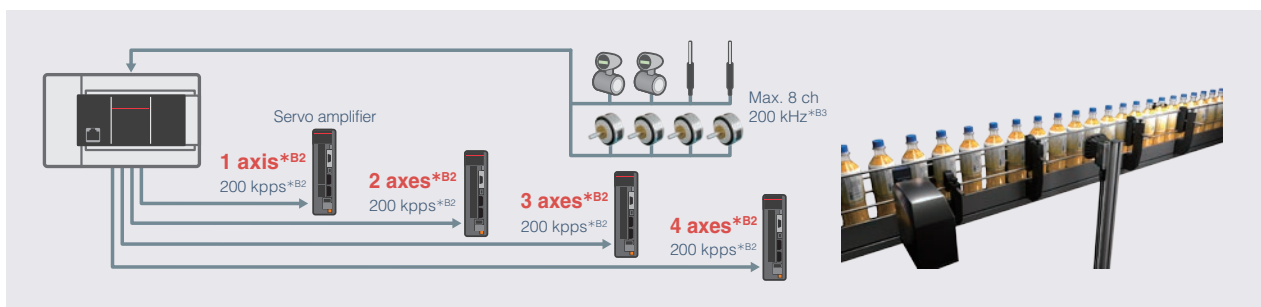

- The CPU module is equipped with a high-speed counter function.
- Allows for building systems at low cost with only a single CPU module.

\*: The max. frequency varies according to the high-speed counter.

Models with restrictions are marked with symbols such as \*A/\*B/\*C. For details of restrictions, refer to P78 [List of annotations].

## Additional high-speed counter channels are available

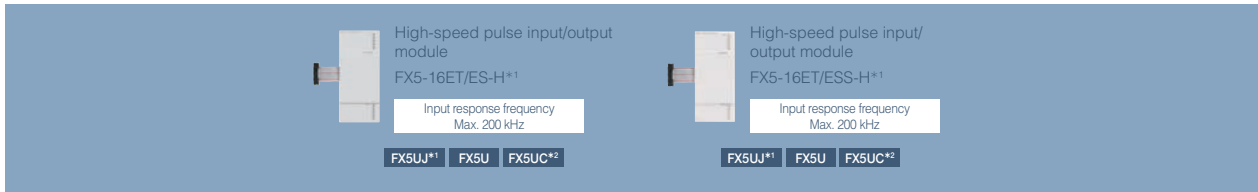

### Supports up to 16 ch high-speed pulse input

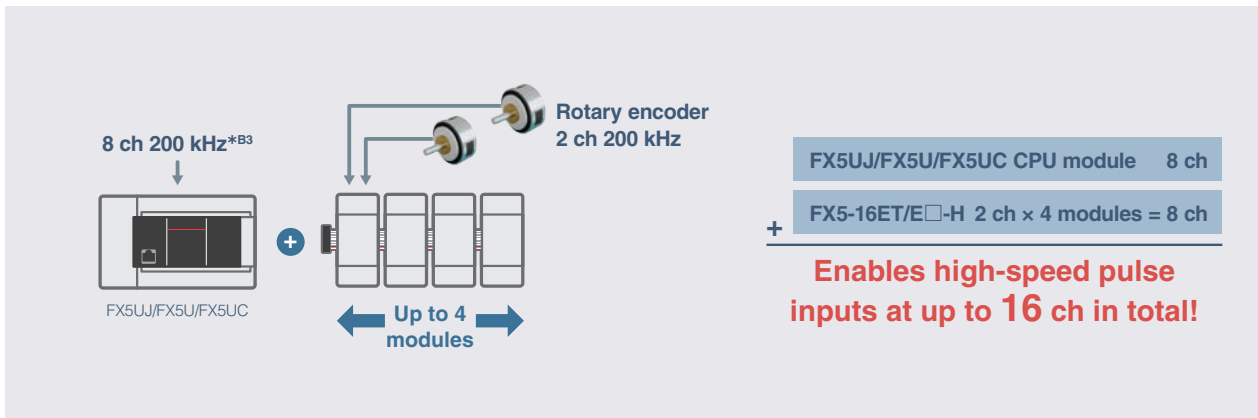

- The number of channels used for high-speed counters can be increased.

### High-speed counter function and positioning function can be used together

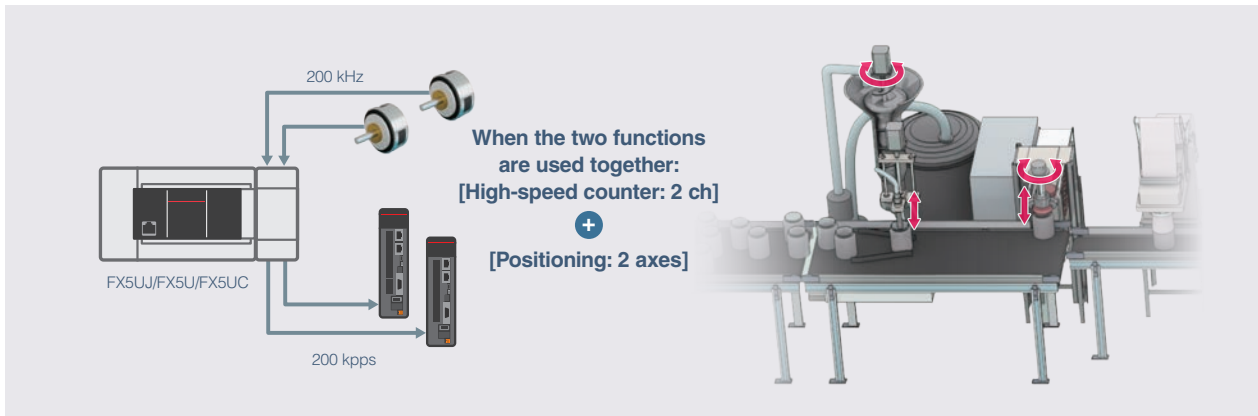

- The high-speed counter function and positioning function can be used together, increasing possible applications.
- The input/output not used for the high-speed counter function and positioning function can be used for general-purpose inputs and outputs.

\*1: The availability of the connection depends on the version of the CPU module. For details, please refer to Chapter 1 Lineup Details and Model Selection or use the FA Integrated Selection Tool.

\*2: Depending on the CPU module, system configuration, serial number, etc., the type and number of connectable modules may differ, or separate equipment may be required for connection. For details, please refer to Chapter 1 Lineup Details and Model Selection or use the FA Integrated Selection Tool.

Models with restrictions are marked with symbols such as \*A/\*B/\*C. For details of restrictions, refer to P78 [List of annotations].

# High-speed input function specification comparison table

✓: Supported, —: Not supported

Function	CPU module			FX5-16ET/ES-H <sup>*1*2</sup> FX5-16ET/ESS-H <sup>*1*2</sup>
	FX5S	FX5UJ	FX5U, FX5UC	
High-speed Counter Function				
Number of channels	8 (CH1 to CH8)	8 (CH1 to CH8)	8 (CH1 to CH8)	Max. 8 (CH9 to CH16)
Maximum frequency	1-phase 1 input counter (S/W)	100 kHz	100 kHz	200 kHz
	1-phase 1 input counter (H/W)	100 kHz	100 kHz	200 kHz
	1-phase 2 input counter	100 kHz	100 kHz	200 kHz
	2-phase 2 input counter [1 edge count]	100 kHz	100 kHz	200 kHz
	2-phase 2 input counter [2 edge count]	50 kHz	50 kHz	100 kHz
	2-phase 2 input counter [4 edge count]	25 kHz	25 kHz	50 kHz
Operation mode	Normal mode	✓	✓	✓
	Pulse density measurement mode	✓	✓	—
	Rotational speed measurement mode	✓	✓	—
Input comparison	High-speed comparison table	✓	✓	✓
	Multiple point high-speed comparison table	✓	✓	—
High-speed counter instructions	Setting 32-bit data comparison	✓	✓	—
	Reset 32-bit data comparison	✓	✓	—
	Comparison of 32-bit data band	✓	✓	—
	Start/stop of the 16/32-bit data high-speed I/O function	✓	✓	✓
	High-speed current value transfer of 16/32-bit data	✓	✓	✓
Pulse width measurement function				
Number of channels	4 (CH1 to CH4)	4 (CH1 to CH4)	4 (CH1 to CH4)	Max. 8 (CH5 to CH12)
Measurement frequencies	100 kHz	100 kHz	200 kHz	200 kHz
Pulse catch function				
Number of input points	16 points	14 points (FX5UJ-24M□) 16 points (Other than above)	16 points	Up to 8 points
Input response time	10 μs, 100 μs, 200 μs	10 μs, 100 μs, 200 μs	5 μs, 100 μs	5 μs, 100 μs
Input response time setting				
Input response time	No setting, 10 μs, 50 μs, 0.1 ms, 0.2 ms, 0.4 ms, 0.6 ms, 1 ms, 5 ms, 10 ms, 20 ms, 70 ms	No setting, 10 μs, 50 μs, 0.1 ms, 0.2 ms, 0.4 ms, 0.6 ms, 1 ms, 5 ms, 10 ms, 20 ms, 70 ms	No setting, 10 μs, 50 μs, 0.1 ms, 0.2 ms, 0.4 ms, 0.6 ms, 1 ms, 5 ms, 10 ms, 20 ms, 70 ms	No setting, 10 μs, 50 μs, 0.1 ms, 0.2 ms, 0.4 ms, 0.6 ms, 1 ms, 5 ms, 10 ms, 20 ms, 70 ms
Hardware filter value	ON	5 μs, 30 μs, 50 μs, 10 ms or less	5 μs, 30 μs, 50 μs, Approx. 10 ms	2.5 μs, 30 μs, 50 μs
	OFF	5 μs, 50 μs, 150 μs, 10 ms or less	5 μs, 50 μs, 150 μs, Approx. 10 ms	2.5 μs, 50 μs, 150 μs
Increment of setting	1 point unit/8 point units	1 point unit/8 point units	1 point unit/8 point units, 8 point units	1 point unit, 8 point units

\*1: The availability of the connection depends on the version of the CPU module. For details, please refer to Chapter 1 Lineup Details and Model Selection or use the FA Integrated Selection Tool.

\*2: Depending on the CPU module, system configuration, serial number, etc., the type and number of connectable modules may differ, or separate equipment may be required for connection. For details, please refer to Chapter 1 Lineup Details and Model Selection or use the FA Integrated Selection Tool.

Models with restrictions are marked with symbols such as \*A/\*B/\*C. For details of restrictions, refer to P78 [List of annotations].

memo

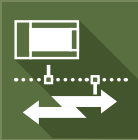

# Network/Communication/Information-sharing

The MELSEC iQ-F series has a built-in Ethernet port and a wide variety of extension devices that can communicate with various networks according to the application.

Can communicate with various networks. The broad lineup allows for meeting the needs of any worksite.

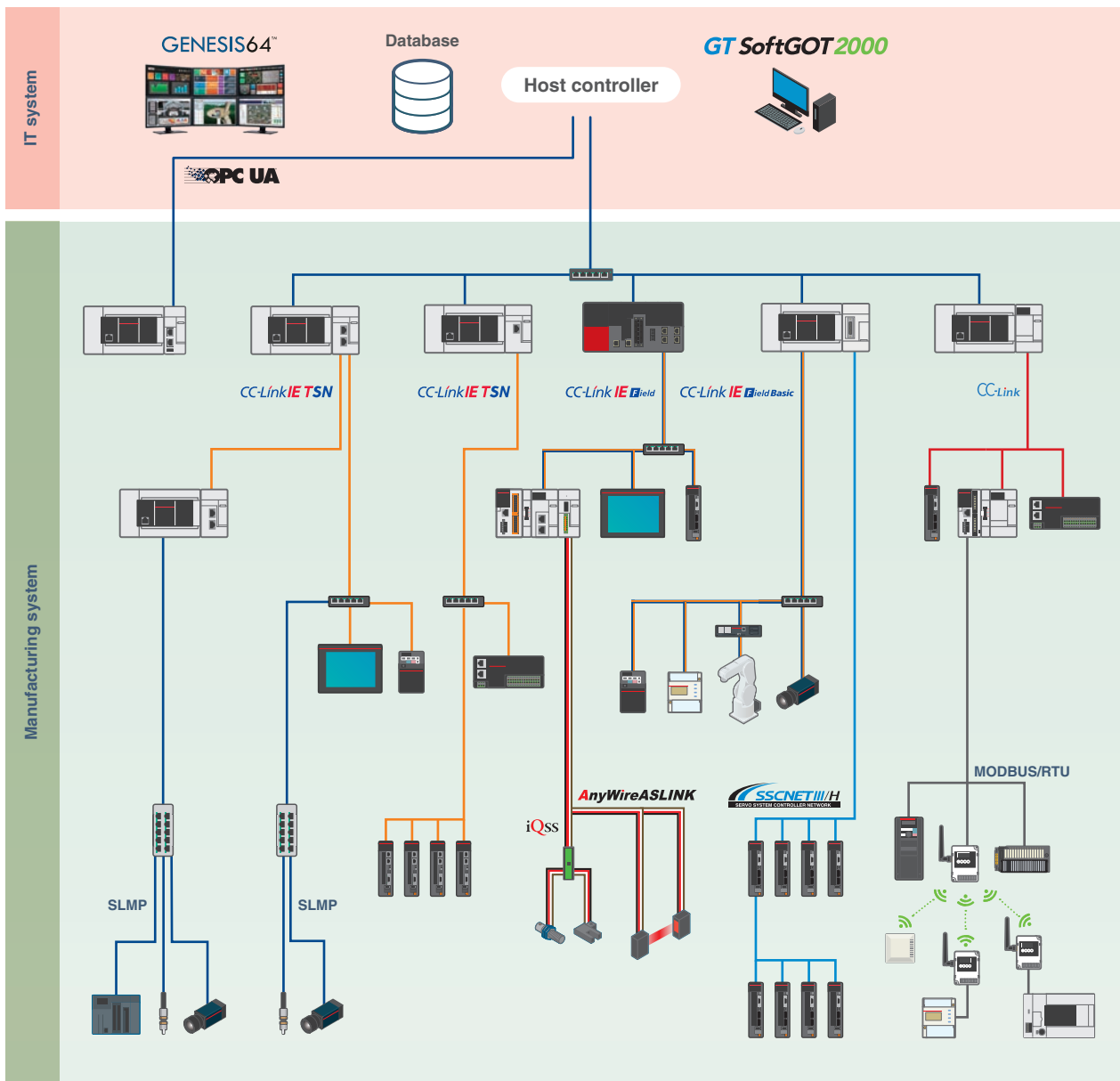

IT system  
CPU Performance  
Analog Control  
Positioning Control  
High-speed Counter Control  
Network/Communication/Information-sharing  
Safety Control  
Programming Environment

Models with restrictions are marked with symbols such as \*A/\*B/\*C. For details of restrictions, refer to P78 [List of annotations].

IT system	<p>▶ <b>To achieve interoperability across manufacturers and other boundaries</b></p> <p>OPC UA.....P59</p> <p><b>Corresponding models</b> FX5-OPC</p> <p><b>Station type</b> Server</p>	
Manufacturing system	<p>▶ <b>To build a factory-wide IIoT infrastructure</b></p> <p>CC-Link IE TSN.....P48</p> <p><b>Corresponding models</b> FX5-CCLGN-MS</p> <p><b>Station type</b> Master station/local station</p>	<p>▶ <b>To connect the production site and IT system</b></p> <p>CC-Link IE Field Network.....P49</p> <p><b>Corresponding models</b> FX5-CCLIEF</p> <p><b>Station type</b> Intelligent device station</p>
	<p>▶ <b>To build a small, inexpensive network</b></p> <p>CC-Link IE Field Network Basic.....P50</p> <p><b>Corresponding models</b> CPU module, FX5-ENET</p> <p><b>Station type</b> Master station</p>	<p>▶ <b>To connect field devices easily</b></p> <p>CC-Link V2.....P51</p> <p><b>Corresponding models</b> FX5-CCL-MS</p> <p><b>Station type</b> Master station/intelligent device station</p>
	<p>▶ <b>To use various communication functions over Ethernet</b></p> <p>General-purpose Ethernet.....P52</p> <p><b>Corresponding models</b> CPU module, FX5-ENET, FX5-ENET/IP</p> <p><b>Station type</b> —</p>	<p>▶ <b>To work alongside other networks</b></p> <p>EtherNet/IP.....P53</p> <p><b>Corresponding models</b> FX5-ENET/IP</p> <p><b>Station type</b> [Class1 instance communications] Originator/target [Class3 communication] Server [UCMM message communications] Server/client</p>
	<p>▶ <b>To construct a building network</b></p> <p>BACnet.....P54</p> <p><b>Corresponding models</b> FX5-ENET, FX5-ENET/IP</p> <p><b>Station type</b> BACnet device (B-ASC)</p>	<p>▶ <b>To build a network that can diagnose sensors with less wiring</b></p> <p>AnyWireASLINK.....P55</p> <p><b>Corresponding models</b> FX5-ASL-M</p> <p><b>Station type</b> Master station</p>
	<p>▶ <b>To operate a large number of sensors/actuators</b></p> <p>PROFIBUS-DP.....P56</p> <p><b>Corresponding models</b> FX5-DP-M</p> <p><b>Station type</b> Master station</p>	<p>▶ <b>To perform MODBUS communication with RS-232C and RS-485</b></p> <p>MODBUS/RTU.....P57</p> <p><b>Corresponding models</b> CPU module, communication board/adaptor</p> <p><b>Station type</b> Master station/slave station</p>
	<p>▶ <b>To perform MODBUS communication with Ethernet</b></p> <p>MODBUS/TCP.....P57</p> <p><b>Corresponding models</b> CPU module</p> <p><b>Station type</b> Master station/slave station</p>	<p>▶ <b>To realize various communication with serial communication</b></p> <p>Serial communication.....P58</p> <p><b>Corresponding models</b> CPU module, communication board/adaptor</p> <p><b>Station type</b> —</p>

CPU Performance  
Analog Control  
Positioning Control  
High-speed Counter Control  
Network/Communication/Information-sharing  
Safety Control

**NEW** FA Integrated Selection Tool

FA Integrated Selection Tool now supports iQ-F. In addition to selecting equipment, you need to consider the configuration from the type of network.



Programming Environment

Models with restrictions are marked with symbols such as \*A/\*B/\*C. For details of restrictions, refer to P78 [List of annotations].



# CC-Link IE TSN

## List of models



Model	Maximum number of connected stations per network	Communication speed
CC-Link IE TSN master/local module FX5-CCLGN-MS*3	61 (for master station)	1 G/100 Mbps
Motion module FX5-40SSC-G*3	Motion control station Up to 4 modules	
	General-purpose station Up to 16 stations	
Motion module FX5-80SSC-G*3	Motion control station Up to 8 stations	
	General-purpose station Up to 16 stations	

FX5UJ\*1   FX5U   FX5UC\*2   FX5U   FX5UC\*2   FX5U   FX5UC\*2

### Characteristics

- CC-Link IE TSN enables coexistence of information communication with the IT system and cyclic communication where the real-time property is assured.

TSN: Time Sensitive Networking

### Simple network configuration

### High-speed communication with a time sharing system

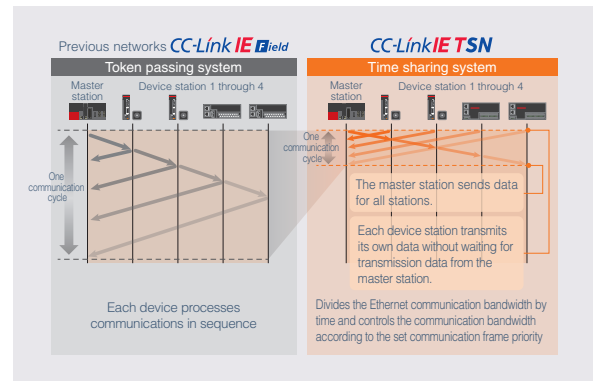
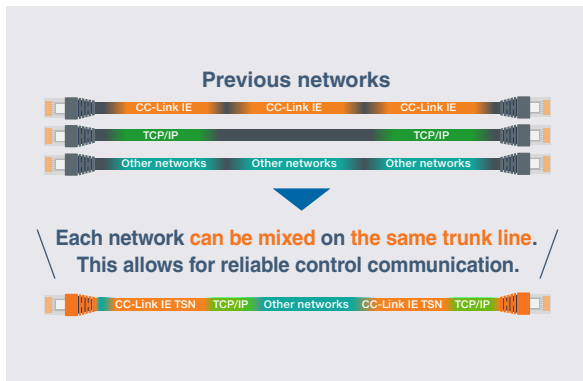

- No need to configure every network! Since TCP/IP communication can be mixed on the same trunk line, a single network can be used.

- High speed is achieved by synchronizing the timing for each device and simultaneously transmitting output and input communication frames in both directions within a time sharing communication cycle.

### Control and information communication over a single network

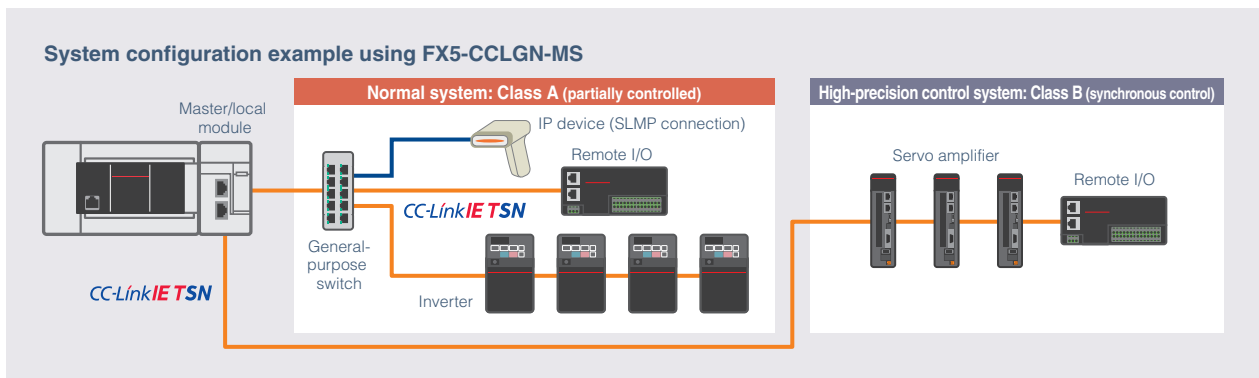

- With CC-Link IE TSN, which uses TSN technology, both general-purpose control and synchronous control can use the same network. Models can be configured to match the level of control needed for each application.

\*1: The availability of the connection depends on the version of the CPU module. For details, please refer to Chapter 1 Lineup Details and Model Selection or use the FA Integrated Selection Tool.  
 \*2: Depending on the CPU module, system configuration, serial number, etc., the type and number of connectable modules may differ, or separate equipment may be required for connection. For details, please refer to Chapter 1 Lineup Details and Model Selection or use the FA Integrated Selection Tool.  
 \*3: For the corresponding station types and CPU modules, refer to P60 [Station type list].

Models with restrictions are marked with symbols such as \*A/\*B/\*C. For details of restrictions, refer to P78 [List of annotations].

CPU Performance  
Analog Control  
Positioning Control  
High-speed Counter Control  
Network/Communication/Information-sharing  
Safety Control  
Programming Environment

# CC-Link IE Field Network

## List of models



CC-Link IE Field Network  
intelligent device station module  
FX5-CCLIEF\*2

Communication speed 1 Gbps	Station number setting range 1 to 120
-------------------------------	--

FX5UJ
FX5U
FX5UC\*1

Characteristics

• CC-Link IE Field Network is a high-speed (1 Gbps) and high-capacity open field network that uses Ethernet (1000BASE-T).

### ▶ Can be connected to CC-Link IE Field Network as an intelligent device station

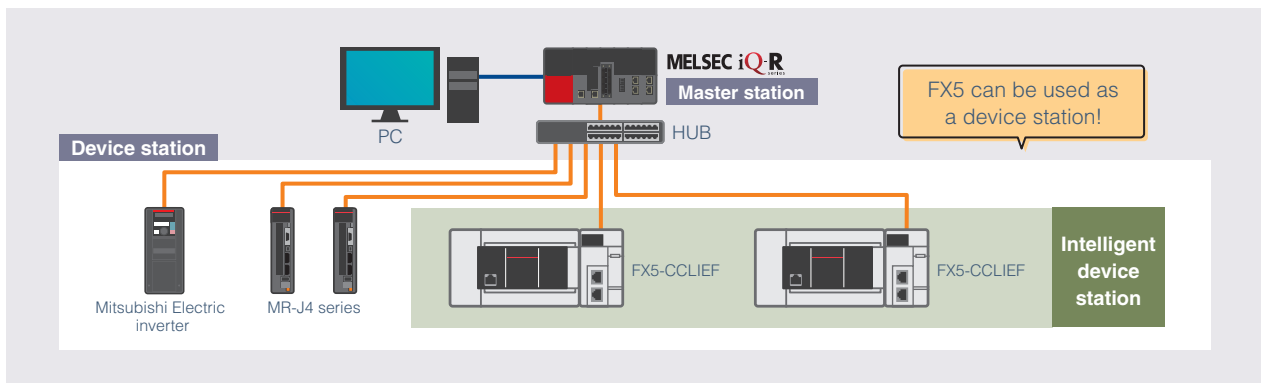

- Meets need from high-speed I/O control to controller distribution control with a single network.
- Controller distribution, I/O control, motion control, safety function, etc. can be set seamlessly.

### ▶ Wiring methods are conveniently flexible

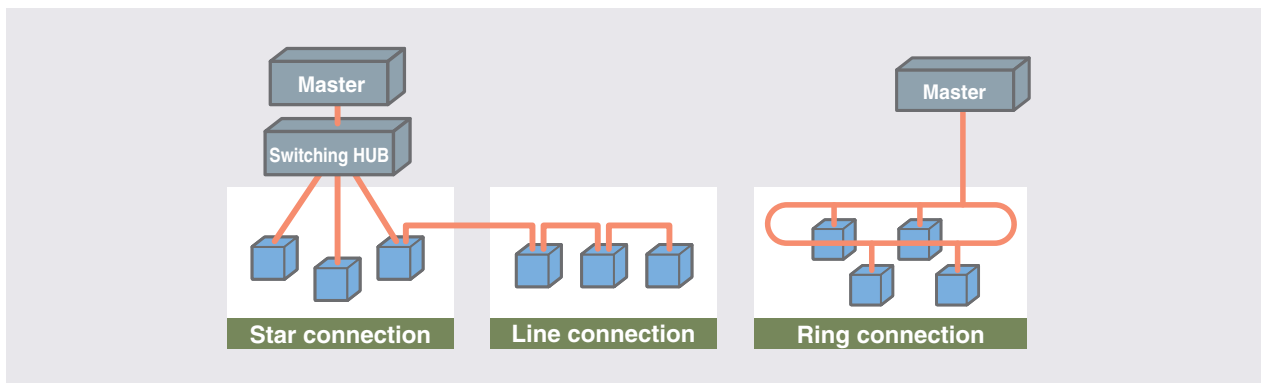

• Connection formats, such as highly reliable ring connection or simple line connection, can be selected based on installation cost.

\*1: Depending on the CPU module, system configuration, serial number, etc., the type and number of connectable modules may differ, or separate equipment may be required for connection. For details, please refer to Chapter 1 Lineup Details and Model Selection or use the FA Integrated Selection Tool.  
 \*2: For the corresponding station types and CPU modules, refer to P60 [Station type list].

Models with restrictions are marked with symbols such as \*A/\*B/\*C. For details of restrictions, refer to P78 [List of annotations].

# CC-Link IE Field Network Basic

## List of models



<p>FX5 CPU module*1 (built-in Ethernet port) Transmission speed 100 Mbps</p> <p>FX5S FX5UJ FX5U FX5UC</p>	<p>Ethernet module FX5-ENET*1 Transmission speed 100 Mbps</p> <p>FX5UJ FX5U FX5UC*2</p>
---	---

**Characteristics** • CC-Link IE Field Network Basic is an FA network utilizing a general-purpose Ethernet.

### Works with CC-Link IE Field Network Basic

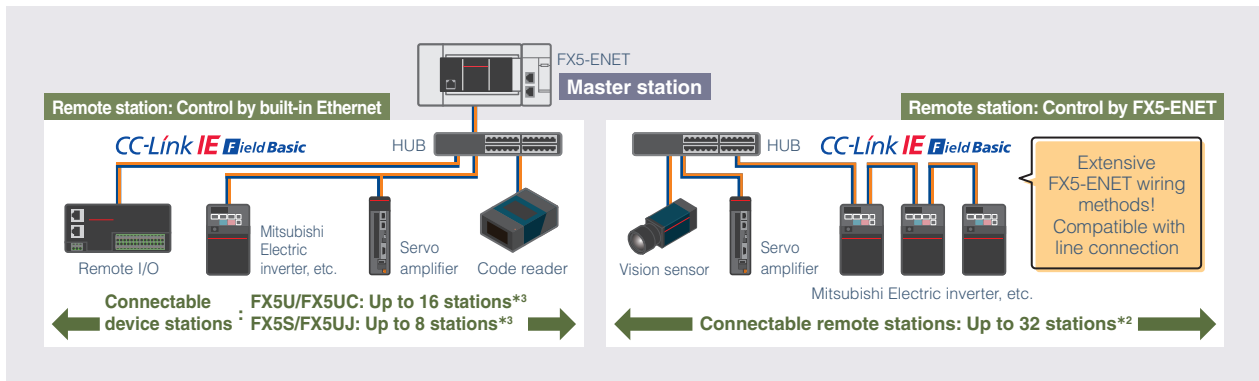

- The CPU module is equipped with the master station function for CC-Link IE Field Network Basic, and can connect up to 16 remote stations\*<sup>C1</sup>.
- Because remote I/O stations connected to CC-Link IE Field Network Basic are not included\*<sup>A8</sup> in the total number of remote I/O points, remote I/O stations can be extended without considering the number of remote I/O points.
- When the FX5-ENET module is connected, CC-Link IE Field Network Basic can be extended up to 32 stations\*<sup>2</sup>.

### Device stations can be grouped

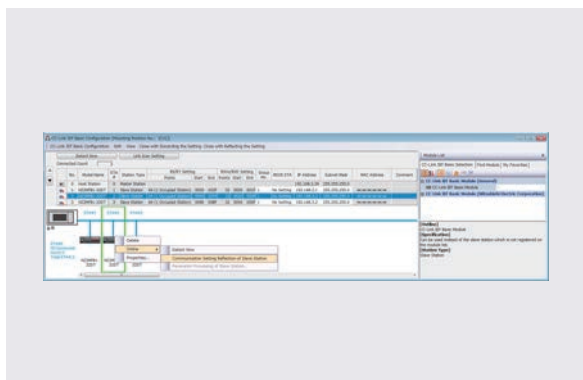

- Remote stations can be grouped according to the length of response processing time.
- This makes it possible to suppress the effects of differences in the reference response time of each device station.

### Works alongside general-purpose Ethernet

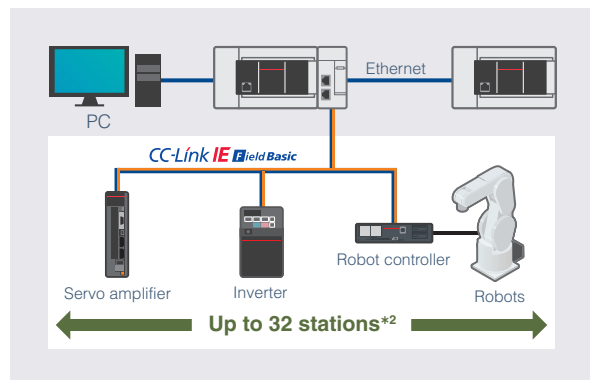

- A single CPU module or FX5-ENET can be connected to both CC-Link IE Field Network Basic and general-purpose Ethernet.

\*1: For the corresponding station types and CPU modules, refer to P60 [Station type list].  
 \*2: Depending on the CPU module, system configuration, serial number, etc., the type and number of connectable modules may differ, or separate equipment may be required for connection. For details, please refer to Chapter 1 Lineup Details and Model Selection or use the FA Integrated Selection Tool.  
 \*3: A firmware upgrade may be required to use some functions and modules. For details, refer to appendix P77 [Function compatibility table].

Models with restrictions are marked with symbols such as \*A/\*B/\*C. For details of restrictions, refer to P78 [List of annotations].

CPU Performance  
Analog Control  
Positioning Control  
High-speed Counter Control  
Network/Communication/Information-sharing  
Safety Control  
Programming Environment

# CC-Link V2

## List of models



CC-Link System master  
intelligent device module  
FX5-CCL-MS\*1

Transmission speed  
156 kbps/625 kbps/2.5 Mbps/5 Mbps/10 Mbps

FX5UJ
FX5U
FX5UC\*2

**Characteristics** • CC-Link V2 is a world-standard open field network that can connect a variety of FA equipment.

### ▶ Equipped with master station/ intelligent device station functions

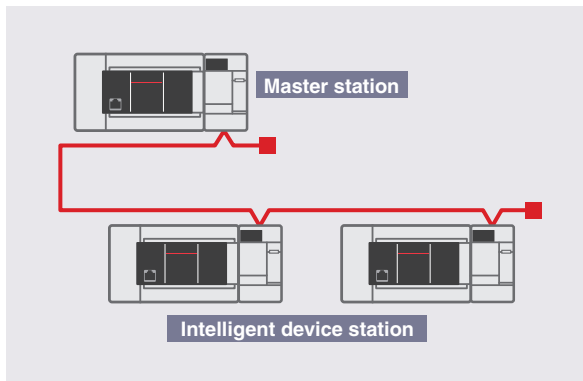

- The FX5-CCL-MS module is equipped with both the master station function and the intelligent device station function, and can be used as either station when switched by a parameter.

### ▶ Seamless access to other stations

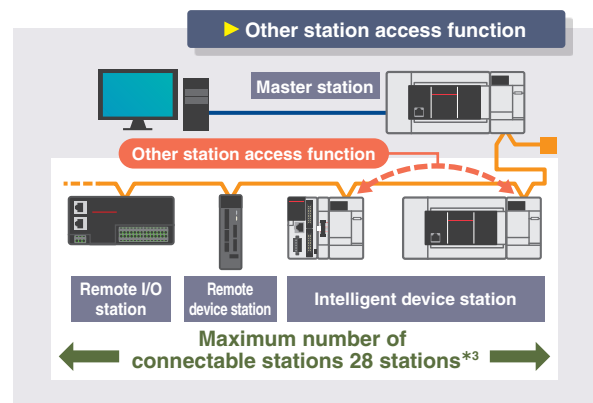

- Perform program write/read and device monitoring, etc. for another station's PLC within the same network.
- There is no need to program each module individually, and the CPU modules built into devices can be easily accessed.

### ▶ Master station settings control the entire system

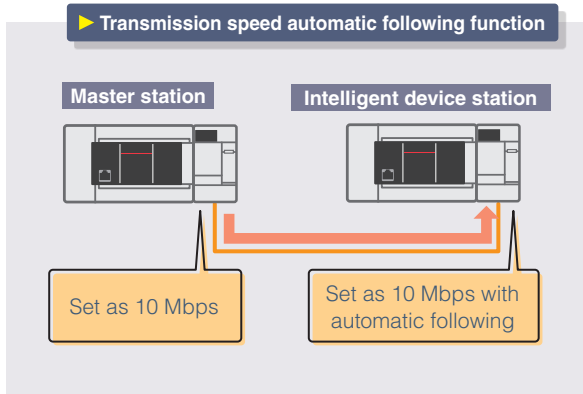

- When used as an intelligent device station, the transmission speed can be set to automatic following. The transmission speed automatically follows the transmission speed of the master station, preventing setting errors.

\*1: For the corresponding station types and CPU modules, refer to P60 [Station type list].  
 \*2: Depending on the CPU module, system configuration, serial number, etc., the type and number of connectable modules may differ, or separate equipment may be required for connection. For details, please refer to Chapter 1 Lineup Details and Model Selection or use the FA Integrated Selection Tool.  
 \*3: When FX5-CCL-MS is added to the FX5U/FX5UC CPU module. When the FX5UJ CPU module or FX3U-16CCL-M is used, the maximum number of connectable stations is different from the number shown above. For details, refer to the manual.

Models with restrictions are marked with symbols such as \*A/\*B/\*C. For details of restrictions, refer to P78 [List of annotations].

# General-purpose Ethernet

## List of models

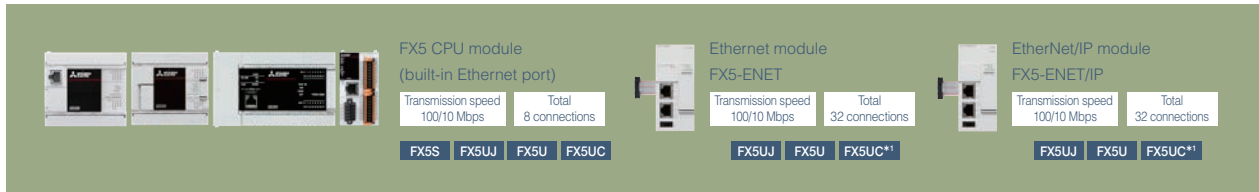

### Characteristics

- Ethernet is a technical standard for control networks that perform communication between the site and the factory, and connect among FA devices.

## List of Ethernet functions

✓: Supported, —: Not supported

Function	Function overview	CPU module			Ethernet module	
		FX5S	FX5UJ	FX5U/ FX5UC	FX5-ENET	FX5-ENET/IP
Direct connection with MELSOFT	Ethernet-equipped module and MELSOFT product (GX Work3) are connected by single Ethernet cable without using a hub. Communication is done by simply specifying the connection destination; setting the IP address is not required.		✓			✓
MELSOFT connection	Communication with MELSOFT products (GX Works3, etc.) is done within LAN such as company internal LAN.		✓			✓
Connected module search function	Searches for Ethernet-equipped module connected with personal computer using GX Works3 within the same hub. Acquires IP address by selecting from search results list.		✓			✓
MELSOFT diagnosis function	Diagnoses Ethernet port of Ethernet-equipped module and Ethernet module from GX Works3. (Ethernet diagnostics)		✓			✓
SLMP communication function*2	Reads and writes PLC data from other device.		✓			✓
Predefined protocol support function	When the predefined protocol support function is used, data can be exchanged with the external device.		✓			—
Socket communication function	By using socket communication instructions, any data can be transferred from and to the external devices connected through Ethernet using TCP or UDP.		✓			✓
MODBUS/TCP communication*2	By using sequence program, MODBUS devices of the external devices connected through Ethernet can be read/written.		✓			—
File transfer function (FTP server)*2	Using the dedicated FTP commands enables an external device to read out, write, and delete individual data file.		✓			—
File transfer function (FTP client)*2	The CPU module becomes an FTP client and can execute file transfer with the FTP server connected to Ethernet using the file transfer function instruction.		✓			—
Time setting function (SNTP client)*2	Time information is collected from the time information server (SNTP server) connected on the LAN at the specified timing, and the CPU module's time is automatically set.		✓			—
Web server function*2	Monitors and diagnoses the CPU module using a Web browser via connected network.		✓			—
IP filter function*2	This function identifies IP address of the access source and prevents access by unauthorized IP addresses.		✓			✓
Remote password	Remote password setting can prevent unauthorized access from the outside and enhance the security of the system.		✓			—
Simple CPU communication function*2	Allows data communications between specified devices at the specified timing just by doing simple parameter settings from an engineering tool for the Ethernet-equipped module.		✓			✓
IP address change function	This function is provided to change the IP address of the CPU module by setting the desired IP address to special registers from a peripheral unit or another unit and turning ON a special relay.		✓			✓
CC-Link IE Field Network Basic	Data is periodically communicated between the master station and remote stations using link devices (cyclic transmission).		✓		✓	—
EtherNet/IP communication	The module can communicate seamlessly with an EtherNet/IP network by using the communication protocol CIP.		—		—	✓
Automatic detection of connected devices	Detects devices supporting iQSS which are connected to the CPU module (built-in Ethernet port), and automatically displays them on "List of devices" and "Device map area" using an engineering tool.		✓			—
Communication setting reflection of Ethernet device	Reflects the communication settings (such as IP addresses) in devices supporting iQSS in "Device map area" which are connected over Ethernet.		✓			—
Sensor parameter read/write	Reads/writes parameters from/to iQSS-compatible devices.		✓			—
BACnet function	Uses a PLC system as a BACnet device.		—			✓

\*1: Depending on the CPU module, system configuration, serial number, etc., the type and number of connectable modules may differ, or separate equipment may be required for connection. For details, please refer to Chapter 1 Lineup Details and Model Selection or use the FA Integrated Selection Tool.

\*2: A firmware upgrade may be required to use some functions and modules. For details, refer to appendix P77 [Function compatibility table].

Models with restrictions are marked with symbols such as \*A/\*B/\*C. For details of restrictions, refer to P78 [List of annotations].

# EtherNet/IP

## List of models

EtherNet/IP module  
FX5-ENET/IP  
Communication speed 100 Mbps  
Total 32 connections  
FX5UJ FX5U FX5UC\*

### Characteristics

- EtherNet/IP is an open network using the CIP communication protocol and works alongside general-purpose Ethernet.

## Can be connected to EtherNet/IP networks

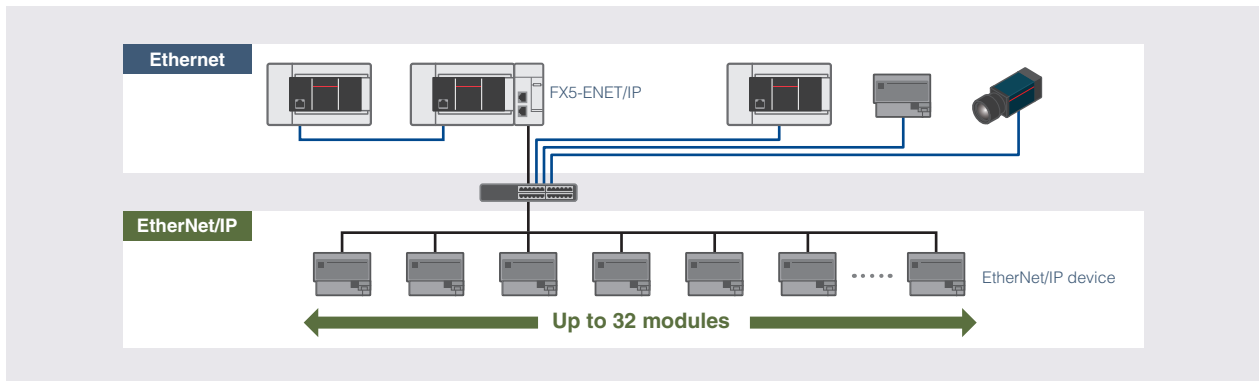

- It can seamlessly communicate with EtherNet/IP networks using the CIP communication protocol. EtherNet/IP and general-purpose Ethernet communication can coexist.
- Can be set to stop or continue EtherNet/IP communication. EtherNet/IP communication can be continued even if the CPU module is in the STOP state.

## Dedicated configuration tool allows for setting of parameters for EtherNet/IP communication

### Even easier to use!

Language selection and installation is now possible.<sup>\*A9</sup>

### Improved controllability!

The configuration tool can now be launched from the GX Works3 screen.<sup>\*A10</sup>

- Except for EtherNet/IP communication-related settings, it can also detect EtherNet/IP devices on the network and configure EtherNet/IP communication settings online.
- A dedicated configuration tool, EtherNet/IP Configuration Tool for FX5-ENET/IP, is available. English or Japanese can be selected during installation.

FX5-ENET/IP enables communication using an Ethernet connection. For functions, refer to P52 [General-purpose Ethernet]

\*: Depending on the CPU module, system configuration, serial number, etc., the type and number of connectable modules may differ, or separate equipment may be required for connection. For details, please refer to Chapter 1 Lineup Details and Model Selection or use the FA Integrated Selection Tool.

Models with restrictions are marked with symbols such as \*A/\*B/\*C. For details of restrictions, refer to P78 [List of annotations].



# BACnet

## List of models

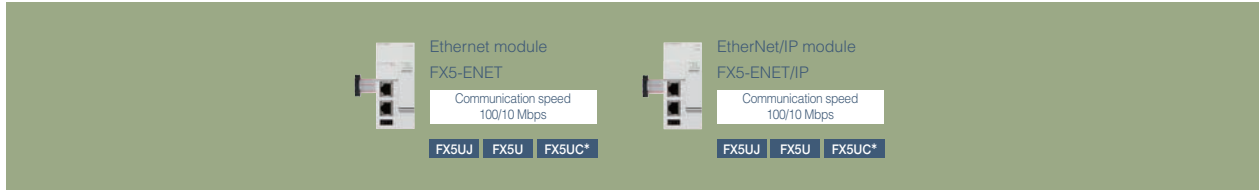

### Characteristics

- BACnet is an open communication standard for building networks established in 1995 by ASHRAE (American Society of Heating, Refrigerating and Air-Conditioning Engineers). BACnet can be implemented together with other general Ethernet protocols.

## Integrated management of equipment and facilities related to building maintenance is possible

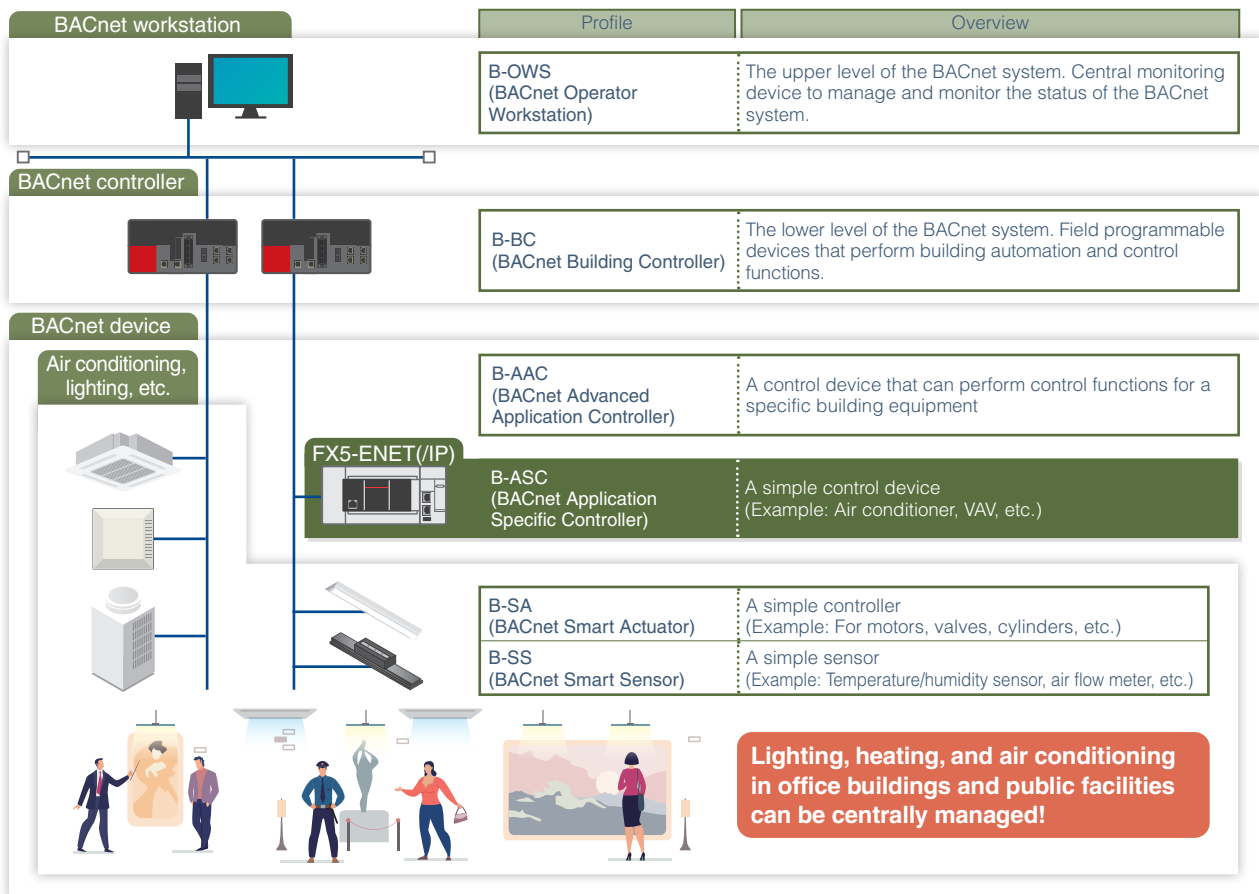

- Compatible with BACnet, an open network in the building air conditioning field.
- By using the BACnet function, it operates as a BACnet device in the BACnet system.
- Lighting, heating and air conditioning, security management systems, etc. can be controlled. This allows for construction of cost-effective air conditioning systems.

## BACnet standards

Item	FX5-ENET, FX5-ENET/IP		
Profile (Role)	B-ASC		
Supported standards	·ANSI/ASHRAE Standard 135-2016 ·ANSI/ASHRAE Standard 135-2004	·ANSI/ASHRAE Standard 135-2012 ·IEIEJ-G-0006:2006 Addendum-a	·ANSI/ASHRAE Standard 135-2010

\*: Depending on the CPU module, system configuration, serial number, etc., the type and number of connectable modules may differ, or separate equipment may be required for connection. For details, please refer to Chapter 1 Lineup Details and Model Selection or use the FA Integrated Selection Tool.

Models with restrictions are marked with symbols such as \*A/\*B/\*C. For details of restrictions, refer to P78 [List of annotations].

CPU Performance  
Analog Control  
Positioning Control  
High-speed Counter Control  
Network/Communication/Information-sharing  
Safety Control  
Programming Environment

# Sensor Solution (AnyWireASLINK system)

## List of models

**AnyWireASLINK**

AnyWireASLINK system master module  
FX5-ASL-M  
Number of modules connected to remote module  
Up to 128 modules

FX5UJ FX5U FX5UC\*1

### Characteristics

- AnyWireASLINK is a flexible sensor network that realizes wiring saving and man-hour reduction using small remote I/O modules, and status monitoring and preventive maintenance using sensors directly connected to the network.

## Visualization of sensors allows for preventive maintenance

Topology free\*2 x total distance 200 m\*3 x  
The number of connectable modules is 128 modules\*4

A wide variety of sensors from Anywire Corporation can be used!

ASLINKER ASLINKTERMINAL ASLINKAMP ASLINKSENSOR

Powered by **Anywire**

- Can be connected to the AnyWireASLINK system from Anywire Corporation.
- Visualization of sensors has been improved through collaboration between sensors and Mitsubishi Electric FA products, which assists in preventive maintenance efforts such as sensor disconnection detection.
- No minimum distance and wiring method between terminals are specified, allowing flexible branching and connection.

## Preventive maintenance prevents problems before they occur

ON (sufficient)  
ON (caution)  
OFF (insufficient)

Initial As time passes

Condition monitoring  
Parameter change

Dust makes sensing impossible

- Seamless communication like a single network using a common protocol, SLMP. Information can be easily collected and equipment monitored and maintained from anywhere in the office or worksites.

## Can be used for equipment in remote locations

Remote address change function

ID0 remote module changed to ID30

GOT

ID0 to ID30 change complete!

- ID (address) can be changed for a single remote module from the buffer memory without using an address writer. Remote IDs can be changed remotely.

\*1: Depending on the CPU module, system configuration, serial number, etc., the type and number of connectable modules may differ, or separate equipment may be required for connection. For details, please refer to Chapter 1 Lineup Details and Model Selection or use the FA Integrated Selection Tool.  
\*2: There is no regulation about such as the specification of branching method and minimum distance between terminals.  
\*3: Total extension distance including branch line length.  
\*4: The number varies depending on current consumption of each remote module.

Models with restrictions are marked with symbols such as \*A/\*B/\*C. For details of restrictions, refer to P78 [List of annotations].

CPU Performance

Analog Control

Positioning Control

High-speed Counter Control

Network/Communication/Information-sharing

Safety Control

Programming Environment

# PROFIBUS-DP

## List of models

PROFIBUS-DP master module  
FX5-DP-M\*1  
Number of modules connected to slave module  
Up to 64 modules

FX5UJ FX5U FX5UC\*2

### Characteristics

- PROFIBUS-DP is an industrial field bus developed and maintained by PROFIBUS & PROFINET International (PI). PROFIBUS is used in a wide range of fields mainly in Europe.

### Can be connected to PROFIBUS-DP networks

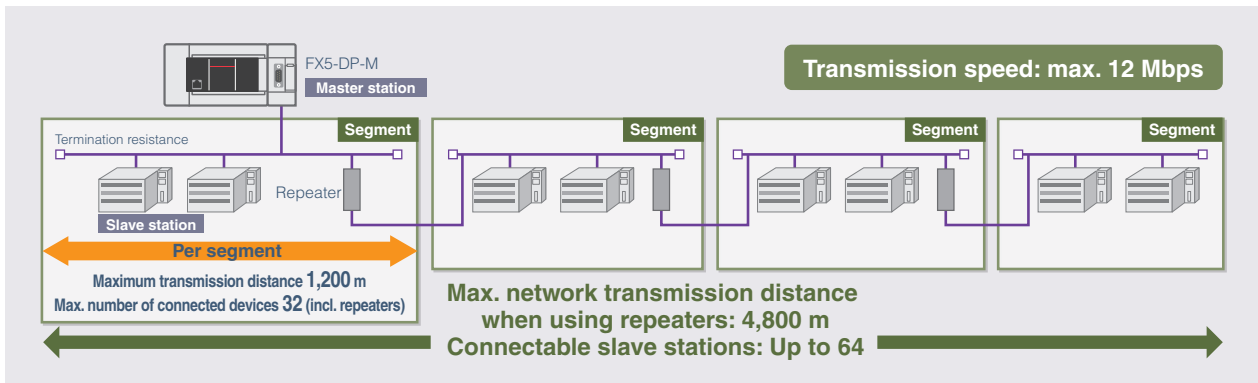

- The MELSEC iQ-F series can be connected as a master station for PROFIBUS-DP networks.

### Obtain communication failure information from slave stations

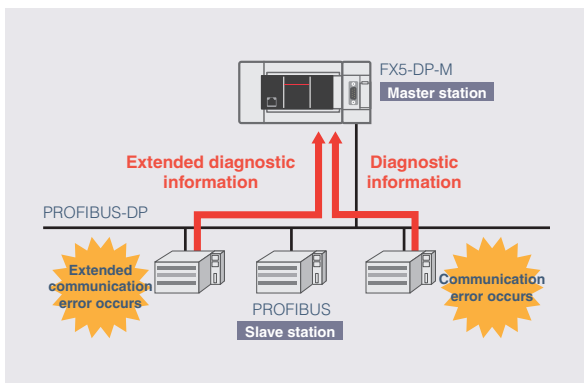

- Using the buffer memory makes it possible to obtain communications error information or extended communications error information generated by a slave station during I/O data transmission.

### Data communication can be done per group

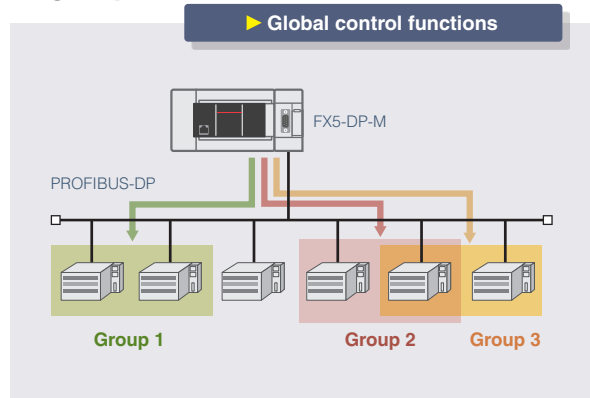

- The global control function allows for synchronous communication of input/output data for each designated group through multicast communication (simultaneous broadcast communication).

### Reading/writing I/O data

- I/O data can be read/written between a CPU module device and the FX5-DP-M buffer memory.
- Configure the refresh settings on the PROFIBUS Configuration Tool, or use MOV instruction or FROM/TO instruction programs.

\*1: For the corresponding station types and CPU modules, refer to P60 [Station type list].  
\*2: Depending on the CPU module, system configuration, serial number, etc., the type and number of connectable modules may differ, or separate equipment may be required for connection. For details, please refer to Chapter 1 Lineup Details and Model Selection or use the FA Integrated Selection Tool.

Models with restrictions are marked with symbols such as \*A/\*B/\*C. For details of restrictions, refer to P78 [List of annotations].

CPU Performance  
Analog Control  
Positioning Control  
High-speed Counter Control  
Network/Communication/Information-sharing  
Safety Control  
Programming Environment

# MODBUS

## List of models [MODBUS/RTU]

Number of modules connected to slave module (for master function) * 32 stations	Number of modules connected to slave module (for master function) 1 station	Number of modules connected to slave module (for master function) 32 stations	Number of modules connected to slave module (for master function) 1 station	Number of modules connected to slave module (for master function) 32 stations
FX5U FX5UC	FX5S FX5UJ FX5U FX5UC	FX5S FX5UJ FX5U FX5UC	FX5S FX5UJ FX5U	FX5S FX5UJ FX5U

## List of models [MODBUS/TCP]

FX5 CPU module\* (built-in Ethernet port)

Total 8 connections

FX5S FX5UJ FX5U FX5UC

- Characteristics**
- MODBUS is a communication network for FA devices.
  - Two types available: MODBUS/RTU and MODBUS/TCP.

### MODBUS/RTU communication

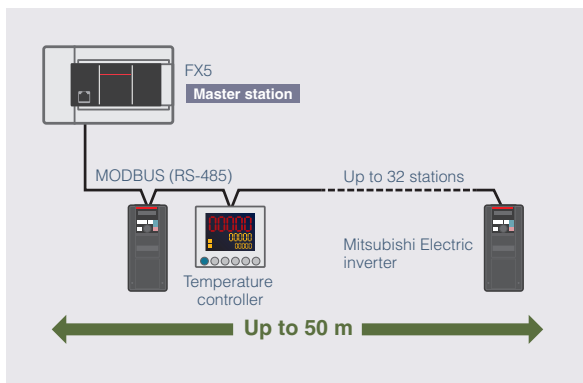

- FX5 CPU module can connect, as a master or slave station of MODBUS communication, to various MODBUS communication devices.

### MODBUS/TCP communication

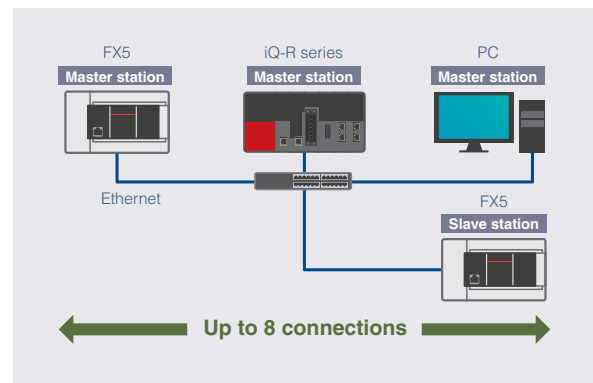

- The FX5 CPU module used as a slave station can be connected to various MODBUS/TCP master devices connected through Ethernet.
- When the FX5 CPU module is used as the master station, it uses the simple CPU communication function or the communication protocol support function to control the slave stations.

### Differences between MODBUS/RTU and MODBUS/TCP

Type	Protocol	Port	Use
MODBUS/RTU	Binary	RS-485 RS-232C	Master/slave
MODBUS/TCP	Binary	Built-in Ethernet port	Master/slave

\*: For the corresponding station types and CPU modules, refer to P60 [Station type list].

Models with restrictions are marked with symbols such as \*A/\*B/\*C. For details of restrictions, refer to P78 [List of annotations].

CPU Performance  
Analog Control  
Positioning Control  
High-speed Counter Control  
Network/Communication/Information-sharing  
Safety Control  
Programming Environment

# Serial communication

## List of models

 FX5U/FX5UC CPU module (built-in RS-485 port) Max. transmission distance 50 m FX5U FX5UC	 RS-232C communication expansion adapter FX5-232ADP Max. transmission distance 15 m FX5S FX5UJ FX5U FX5UC	 RS-485 communication expansion adapter FX5-485ADP Max. transmission distance 1200 m FX5S FX5UJ FX5U FX5UC	 RS-232C communication expansion board FX5-232-BD Max. transmission distance 15 m FX5S FX5UJ FX5U	 RS-485 communication expansion board FX5-485-BD Max. transmission distance 50 m FX5S FX5UJ FX5U
--	---	--	---	--

### Characteristics

- Serial communication is a communication method for connecting the PLC and FA devices via RS-232C or RS-485.
- One communication port enables one type of serial communication. Various types of serial communication can be used simultaneously by adding communication ports.

### Mutually linking data

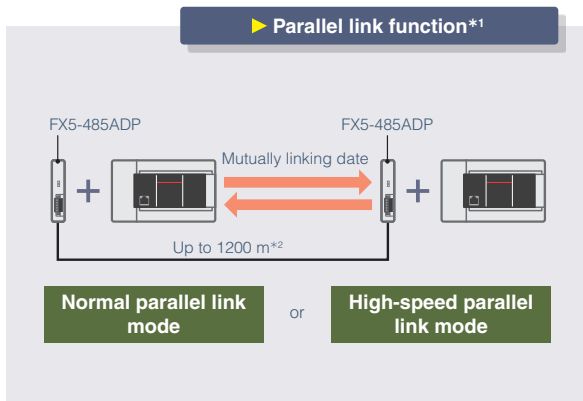

- This function connects two CPU modules and automatically links mutual device data.
- The ON/OFF status of bits and data register values of other stations can be checked.

### Data can be auto-updated

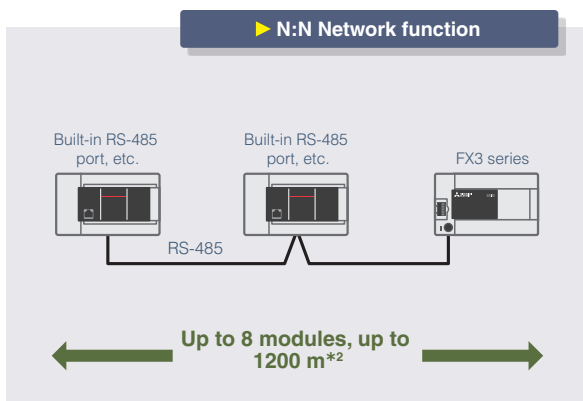

- In this communication, a connection is set up with the FX5 PLC or FX3 PLC through RS-485 communication to automatically exchange data.

### Serial communication with code readers, printers, etc.

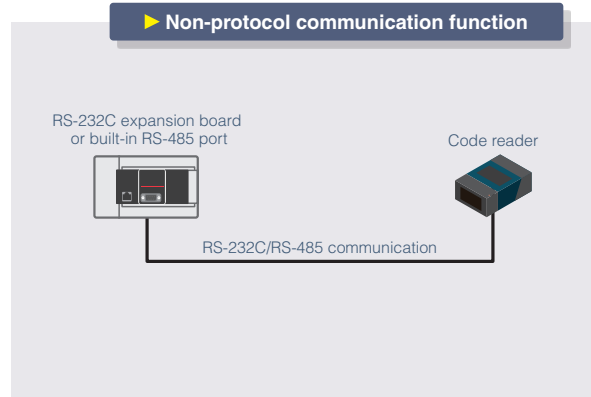

- This function communicates data with code readers, printers, PCs, measuring instruments, etc. without a protocol via the RS-232C/RS-485 interface.
- RS2 instruction can be used for non-protocol communication functions.

### Dedicated instructions for easy operation control

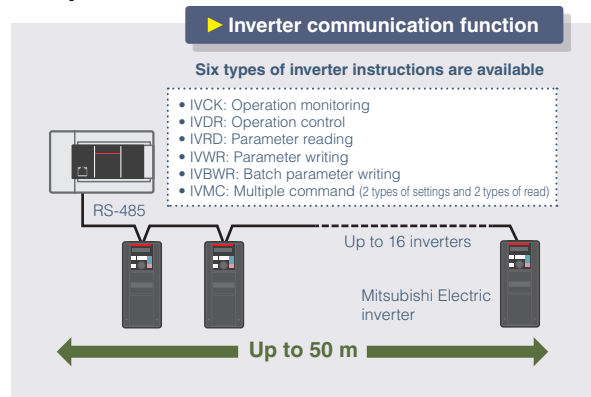

- Up to 16 inverters can be operated and controlled by RS-485 communication.

\*1: A firmware upgrade may be required to use some functions and modules. For details, refer to appendix P77 [Function compatibility table].  
 \*2: 50 m or less when the built-in RS-485 port and FX5-485-BD are included.

Models with restrictions are marked with symbols such as \*A/\*B/\*C. For details of restrictions, refer to P78 [List of annotations].

# OPC UA

## List of models

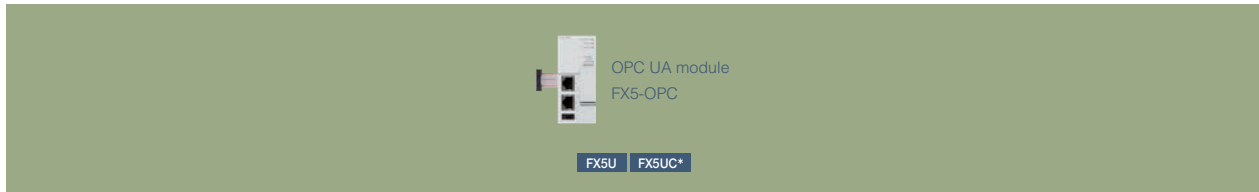

### Characteristics

- OPC UA can be linked with the host systems without a PC. It can replace gateway PCs, which are a security risk, to help create more robust systems.

### ▶ Expanding applications by supporting OPC UA interface

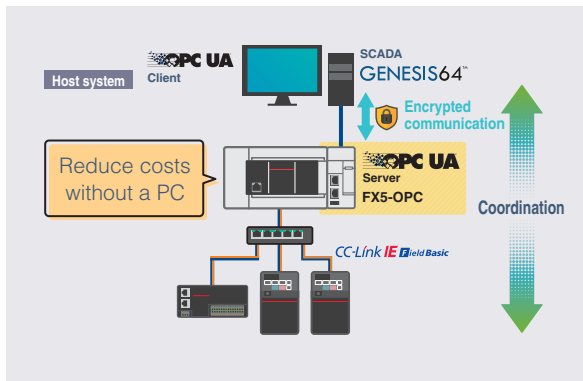

- Can be linked with the host system without a PC.
- This allows for data conversion between multi-vendor products and across different operating systems.

### ▶ The number of man-hours for development can be reduced via the special setting tool.

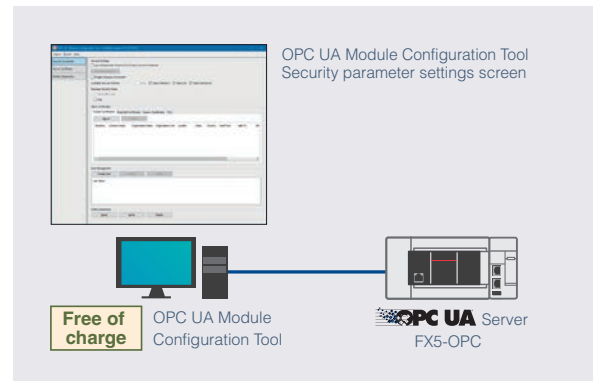

- For a setting of FX5-OPC module parameters and address space parameters, GX Works3<sup>\*A11</sup> is used.
- For a setting of IP addresses and security parameters, control for server certificates, OPC UA Module Configuration Tool<sup>\*12</sup> is used.

### ▶ Increased reliability through enhanced security

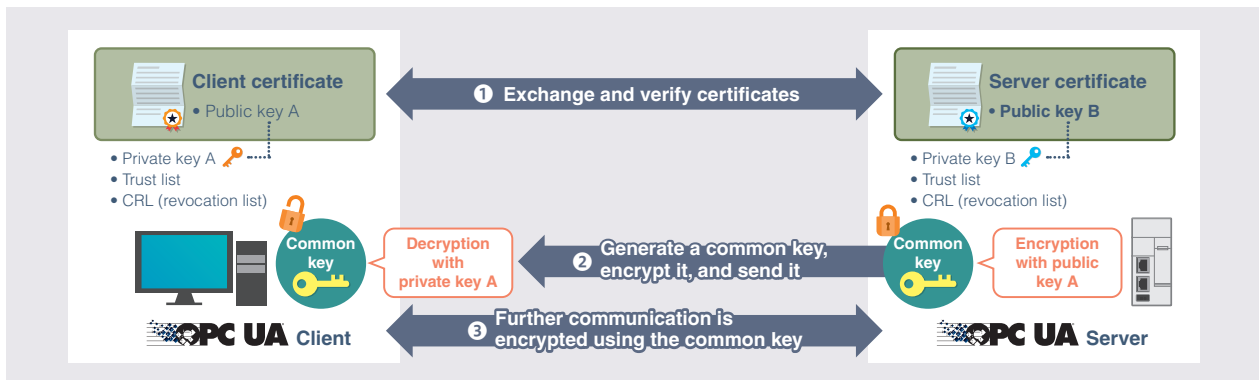

- The OPC UA security functions, such as certificate, encryption, and signing, can be set optionally.
- A common key can be generated for secure communication with OPC UA clients. The generated common key is encrypted and transmitted using the public key contained in the certificate and the corresponding private key.

\*: Depending on the CPU module, system configuration, serial number, etc., the type and number of connectable modules may differ, or separate equipment may be required for connection. For details, please refer to Chapter 1 Lineup Details and Model Selection or use the FA Integrated Selection Tool.

Models with restrictions are marked with symbols such as \*A/\*B/\*C. For details of restrictions, refer to P78 [List of annotations].

CPU Performance

Analog Control

Positioning Control

High-speed Counter Control

Network/Communication/Information-sharing

Safety Control

Programming Environment

## Station type list

Applicable station types vary depending on used modules and devices.

✓: Supported, —: Not supported

Type	Used module/device (Model name)	Station type		Applicable CPU module			
		Master	Device	FX5S	FX5UJ	FX5U	FX5UC
CC-Link IE TSN	FX5-CCLGN-MS	✓	✓	—	✓*1	✓	✓*2
	FX5-40SSC-G	✓	—	—	—	✓	✓*2
	FX5-80SSC-G	✓	—	—	—	✓	✓*2
CC-Link IE Field Network	FX5-CCLIEF	—	✓	—	✓	✓	✓*2
CC-Link IE Field Network Basic	FX5S/FX5UJ/FX5U/FX5UC CPU module (CPU built-in Ethernet port)	✓	—	✓	✓	✓	✓
	FX5-ENET	✓	—	—	✓	✓	✓*2
CC-Link V2	FX5-CCL-MS	✓	✓	—	✓	✓	✓*2
	FX3U-16CCL-M	✓	—	—	—	✓*2	✓*2
	FX3U-64CCL	—	✓	—	—	✓*2	✓*2
PROFIBUS-DP	FX5-DP-M	✓	—	—	—	✓	✓*2
	FX3U-32DP	—	✓	—	—	✓*2	✓*2
MODBUS/RTU	FX5U/FX5UC CPU module (CPU built-in RS-485 port)	✓	✓	—	—	✓	✓
	FX5-232ADP	✓	✓	✓	✓	✓	✓
	FX5-485ADP	✓	✓	✓	✓	✓	✓
	FX5-232-BD	✓	✓	✓	✓	✓	—
	FX5-485-BD	✓	✓	✓	✓	✓	—
MODBUS/TCP	FX5S/FX5UJ/FX5U/FX5UC CPU module (CPU built-in Ethernet port)	✓	✓	✓	✓	✓	✓

Type	Used module/device (Model name)	Station type		Applicable CPU module				
		Server	Client	FX5S	FX5UJ	FX5U	FX5UC	
SLMP	3E frame	FX5S/FX5UJ/FX5U/FX5UC CPU module (CPU built-in Ethernet port)	✓	✓	✓	✓	✓	✓
		FX5-ENET, FX5-ENET/IP	✓	—	—	✓	✓	✓*2
	1E frame	FX5S/FX5UJ/FX5U/FX5UC CPU module (CPU built-in Ethernet port)	✓	—	✓	✓	✓	✓
FX5-ENET, FX5-ENET/IP		✓	—	—	✓	✓	✓*2	
EtherNet/IP	Class3 message communications	✓	—	—	✓	✓	✓*2	
	UCMM message communications	✓	✓	—	✓	✓	✓*2	
OPC UA	FX5-OPC	✓	✓	—	—	✓	✓*2	

Type	Used module/device (Model name)	Station type		Applicable CPU module			
		Scanner	Adapter	FX5S	FX5UJ	FX5U	FX5UC
EtherNet/IP	Class1 instance communications (Cyclic communication)	✓	✓	—	✓	✓	✓*2

\*1: The availability of the connection depends on the version of the CPU module. For details, please refer to Chapter 1 Lineup Details and Model Selection or use the FA Integrated Selection Tool.

\*2: Depending on the CPU module, system configuration, serial number, etc., the type and number of connectable modules may differ, or separate equipment may be required for connection. For details, please refer to Chapter 1 Lineup Details and Model Selection or use the FA Integrated Selection Tool.

Models with restrictions are marked with symbols such as \*A/\*B/\*C. For details of restrictions, refer to P78 [List of annotations].



memo



# Safety Control

Device safety is highly important amid the globalization of various industries and systems. The MELSEC iQ-F series also features a lineup of modules that complies with safety standards.

## List of models

### Safety extension module



Safety main module  
FX5-SF-MU4T5

- Maximum number of connected modules: 1 module
- Number of safety inputs: 4 points
- Number of safety outputs: 4 points
- Safety control programs: 9 types

FX5UJ FX5U FX5UC\*



Safety input expansion module  
FX5-SF-8DI4

- Maximum number of connected modules: 2 modules
- Number of safety inputs: 8 points
- Number of safety outputs: 4 points
- Safety control programs: 9 types

FX5UJ FX5U FX5UC\*

## Challenges and benefits of implementing safety systems

### Challenges

- We alerted our overseas colleagues about the need for security, but we are not sure that the importance was communicated clearly.
- I want to install a safety system, but it is expensive and time-consuming.

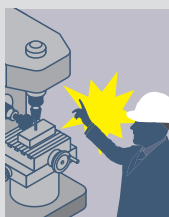

**In the unlikely event of personal injury, the manufacturer would be responsible!**

### Advantage

- When a hazard is detected, the power of hazardous moving equipment, such as robots and conveyors, can be shut off.
- When the safety extension module itself malfunctions, the output can be forcibly turned OFF.



**Safe manufacturing leads to higher productivity!**

## Easily create a system just by connecting a safety extension module

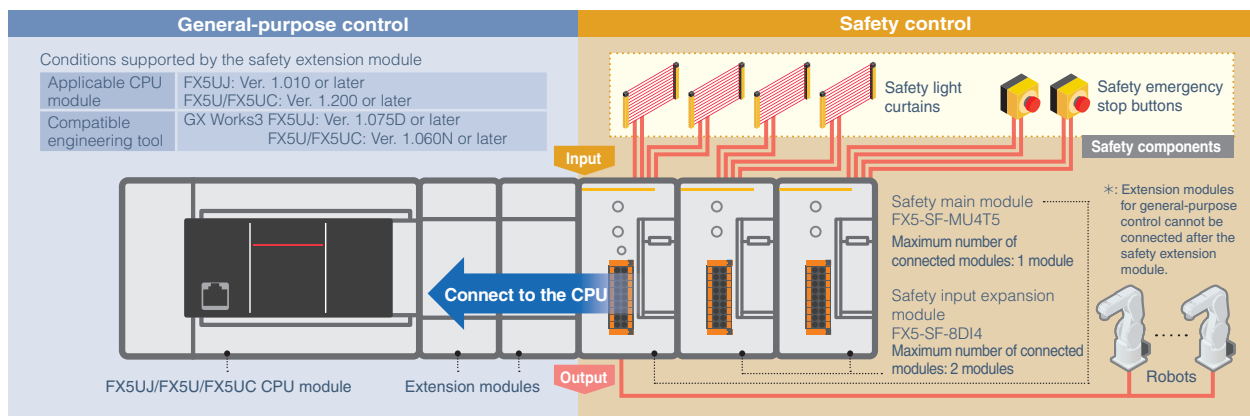

- This single system can be used to perform general-purpose control and safety control.
- A safety control system can easily be installed just by connecting to an FX5UJ/FX5U/FX5UC CPU module.
- No safety program or monitor wiring is required. Reduce the labor required for system construction.

\*: Depending on the CPU module, system configuration, serial number, etc., the type and number of connectable modules may differ, or separate equipment may be required for connection. For details, please refer to Chapter 1 Lineup Details and Model Selection or use the FA Integrated Selection Tool.

Models with restrictions are marked with symbols such as \*A/\*B/\*C. For details of restrictions, refer to P78 [List of annotations].



## ▶ Easy programming by just selecting built-in programs!

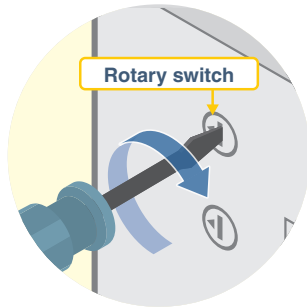

Safety main module  
FX5-SF-MU4T5

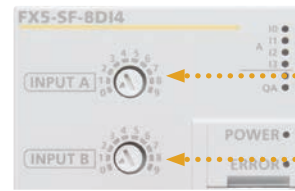

Safety input expansion module  
FX5-SF-8DI4

- FUNCTION Rotary switch
- INPUT A Rotary switch
- INPUT B Rotary switch

For details of the nine types of programs, refer to Chapter 2 Safety Control.

- Nine different programs are built in.
- A safety system can be constructed by simply turning a rotary switch with a precision screwdriver, etc. to select it.
- This eliminates the need for sequence programs designed for safety control.

## ▶ Use the Safety Extension Module Configuration Guide to determine the wiring at a glance!

**The configuration guide makes it possible to:**

- Check the connection terminals of the I/O devices
- Check when the rotary switch was changed
- Check the wiring diagram
- Print the created wiring diagram

Check the printed configuration guide to wire the module

The configuration guide is free of charge!\*

The display of the program outline diagram changes to match the selected program number

Set the program number with the rotary switch

Click ▼ and ▲ to change the program number

**STEP 1**  
Place the safety extension module.

**STEP 2**  
Click the device to connect.

**STEP 3**  
Select the connection destination.

**STEP 4**  
The set device is applied to the configuration.

- Easily check the system configuration, settings, and wiring of the safety extension module.

## ▶ Safety module status can be checked from the PLC!

Module diagnostics screen examples

Even troubleshooting is easy!

**GX Works3**

- Safety extension module information, such as error codes, are stored in the buffer memory of the safety main module.
- Information, such as the error details and countermeasures, can be checked from the module diagnosis function of GX Works3, which helps when troubleshooting issues.

\*: Please contact your local Mitsubishi Electric sales office or representative.

Models with restrictions are marked with symbols such as \*A/\*B/\*C. For details of restrictions, refer to P78 [List of annotations].



# Programming Environment

GX Works3 is software that comprehensively supports the design and maintenance of sequence programs. Reduce engineering costs with a graphical, intuitive and easy programming by just "selecting".

## GX Works3

One Software, Many Possibilities  
Many possibilities in one software package

- Reduces programming man-hours by graphical intuitive operability
- Complies with international standard IEC 61131-3



### Supports mainstream programming languages

- GX Works3 supports mainstream IEC-compliant programming languages.
- It is possible to use different programming languages simultaneously within a single project.
- Labels and devices used in programs can be shared by programs in different languages.

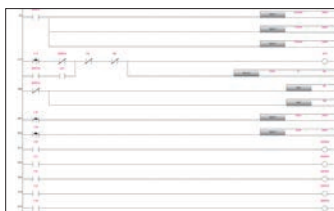

**Ladder language**  
A graphic language that is displayed as a circuit consisting of contacts and coils.

```

CASE 1: ON OF
1 Start_switch = TRUE;  (* Connector assignment *)
2 Start_switch = FALSE; (* Connector stop *)
END_CASE
END_CASE
IF Start_switch = TRUE THEN  (* Connector operation processing (ON state) *)
FOR Processing_time (* 0
TO 100
BY 1 00
Number_of_processes := Number_of_processes + 1;
END_FOR
END_IF
/* The valve closes when the tank level turns on, and opens when the tank level turns off.
IF Tank_level = TRUE THEN
Valve = FALSE; /* The valve is closed because the tank level is turned on. */
Valve = TRUE; /* The valve is opened because the tank level is turned off. */
END_IF
MOTOR_M1_01; /* Motor control ON
IF M1_01 THEN
M1_01; /* Stop no processing, is performed when the motor control is OFF.
M1_01; /* NO retains the value at the time of the previous scan.

```

**ST language**  
As in high-level languages such as C, control is determined by syntax, such as selective branching by conditional statements.

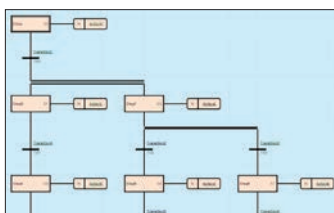

**SFC language**  
This graphical language clarifies the execution order and execution conditions of programs.

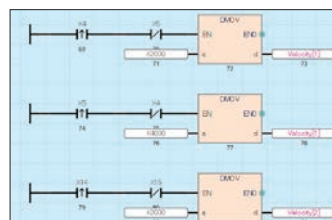

**FBD/LD language**  
This graphical language is used to create control programs with the simple operations of placing and connecting parts.

Models with restrictions are marked with symbols such as \*A/\*B/\*C. For details of restrictions, refer to P78 [List of annotations].

CPU Performance  
Analog Control  
Positioning Control  
High-speed Counter Control  
Network/Communication/Information-sharing  
Safety Control  
Programming Environment

➤ **Easy system design by simply selecting components**

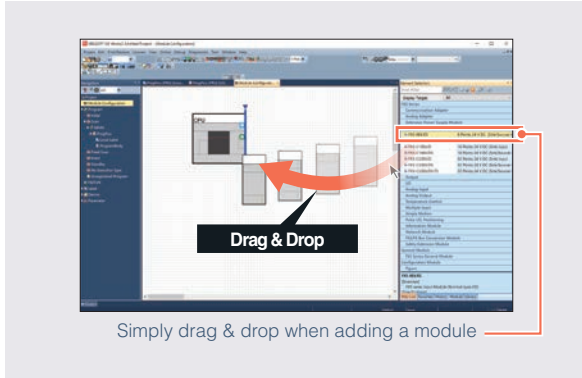

- With GX Works3, the module configuration diagram can be created by dragging and dropping selected parts.

➤ **Auto-generation of module parameters**

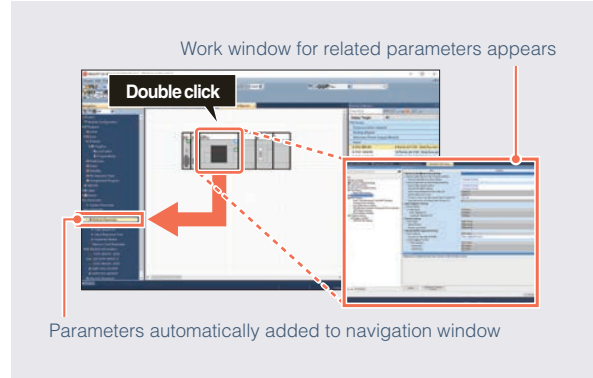

- When preparing the module configuration diagram, simply double-click the module to automatically generate the module parameters.

➤ **Module parameters can be set easily**

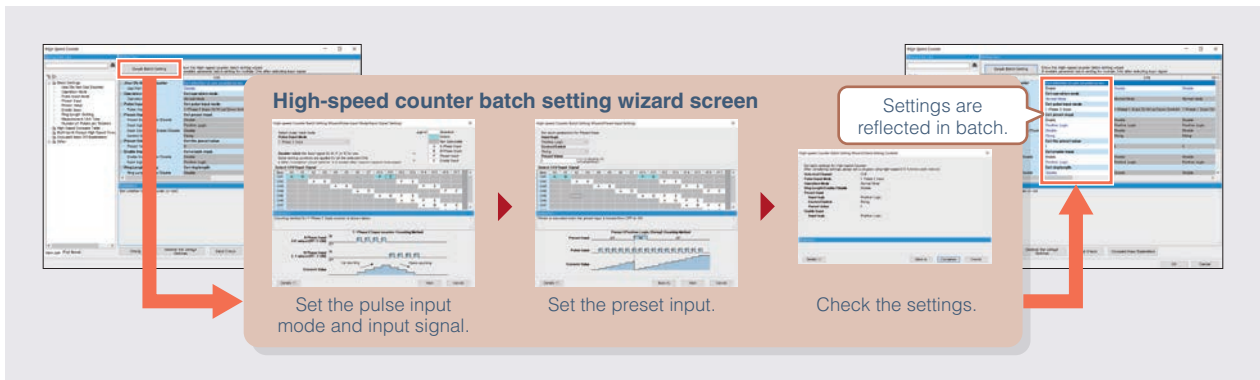

- Module parameters can be set without a manual by simply following the wizard.
- You can also easily check the high-speed counter CH used and the location of wiring.

➤ **Reduces programming man-hours with simple, convenient parameter settings**

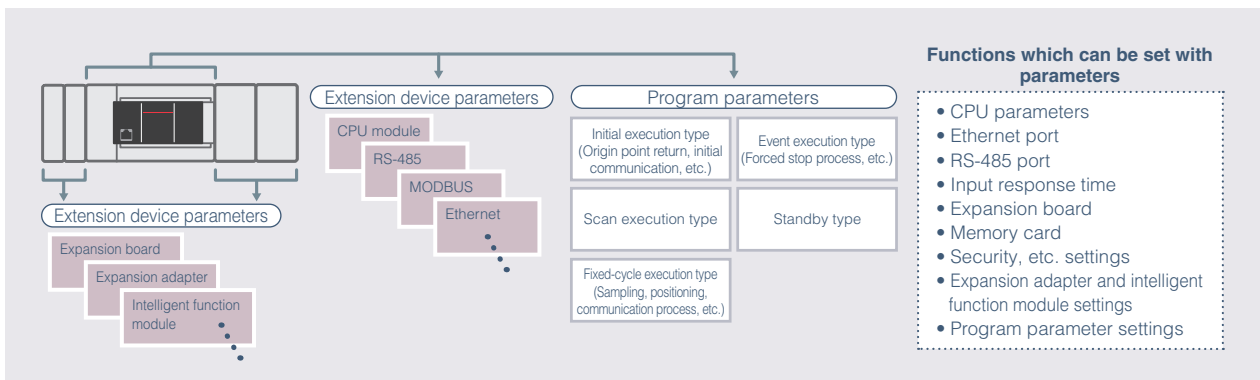

- Device settings can be input as a table.
- Easily set just by inputting values into the parameters.
- The program's execution trigger can also be set with the parameters.

Models with restrictions are marked with symbols such as \*A/\*B/\*C. For details of restrictions, refer to P78 [List of annotations].

## ➤ Reduces repetitive programming tasks with labels

Global Label Editor

Module Label

Local Label Editor

Drag & Drop

Drag & Drop

Programs made by someone can be easily understood by using labels. Readout is possible by using a label name.

- Labels can be used instead of conventional device memory addresses, I/O addresses, and buffer memory addresses.
- Defining labels, such as the name of signals used in devices, improves the readability of programs.
- Module labels corresponding to input/output signals, etc., of various intelligent function modules are pre-defined. Programming can be done without being conscious of the buffer memory addresses.

## ➤ The use of a structure can further reduce programming man-hours

If relevant information is collected within the program and integrated into a structure...

GX Works3

Structures

Member	Switch 1
Member	Switch 2
Member	Switch 3

A previously made structure can be used.

The structure can be used for another purpose within the program.

It can be used for the programs of other equipment.

- A structure can integrate the variables of a specific basic data type as members into one. Each member (label) can be defined even when the data types are different.
- A structure can be used to access a device with the label name regardless of the device address.

## ➤ Providing the convenience of special devices

MELSEC iQ-R

MELSEC iQ-F

FX3 series (FX3G/FX3U/FX3UC)

Newly increased system devices

Total 12000 devices

Conventional convenient devices

Available by conversion\*1

- M8000~ → SM8000\*2~
- D8000~ → SD8000\*2~

- Up to 12000 points of convenient system devices compatible with upper level devices have been added.

## ➤ Customizes the latch range setting for each device

Item	Symbol	Points	Range	Latch (L)	Latch (C)
Input	X	0001	0 to 1777		
Output	Y	1004	0 to 1777		
Internal Relay	M	7680	0 to 7679	0 to 7679	No Setting
Link Relay	0	256	0 to FF	No Setting	No Setting
Link Special Relay	S0	412	0 to FF	No Setting	No Setting
Annunciator	F	128	0 to 127	No Setting	No Setting
Step Relay	S	4096	0 to 4095	0 to 4095	No Setting
Timer	T	512	0 to 511	No Setting	No Setting
Retentive Timer	RT	16	0 to 15	0 to 15	No Setting
Counter	C	256	0 to 255	0 to 199	No Setting
Lone Counter	LC	64	0 to 63	20 to 63	No Setting
Data Pointer	D	8000	0 to 7999	200 to 7999	No Setting
Latch Relay	L	7680	0 to 7679		
Area Capacity			12.0K Word		11.0K Word
Total Device			11.2K Word		9.8K Word
Total Word Device			10.2K Word		8.1K Word
Total Bit Device			15.9K Bit		25.1K Bit

- In the FX5S/FX5U/FX5UC CPU module, the latch range can be set for each device and the clear object can be selected when the CPU memory is operated.

\*1: When projects for the FX3G/FX3U/FX3UC created using GX Works2 are diverted for the MELSEC iQ-F series, devices are automatically converted.  
 \*2: Some device names and device numbers may differ.

Models with restrictions are marked with symbols such as \*A/\*B/\*C. For details of restrictions, refer to P78 [List of annotations].







## ▶ Check the parameter setting procedure in flow

Displays preparation/setting procedures for selected functions

**Point**  
Preparation column displays tasks to be performed outside of GX Works3 to prevent omissions!

▶ Guidance flow function\*<sup>A14</sup>

Select the function you want to use

Click on the link on the procedure screen

Jump to setting screen

- Parameters can be set efficiently as they follow the flow.
- It is also possible to jump to a setting item from each item on the flow.

## ▶ CPU module simulation

**Actual device not needed!**

- With GX Simulator3, programs can be debugged with a virtual PLC on the computer.
- It is also useful for checking program operation before installing actual devices.

## ▶ Simple motion simulation\*

**Actual device not needed!**

- Simulation can be done without going to the site, which reduces programming man-hours.
- Even without a servo motor or amplifier, it is possible to check operation closer to actual machine tests.

\*: Supported by GX Works3 Ver. 1.035M or later.

Models with restrictions are marked with symbols such as \*A/\*B/\*C. For details of restrictions, refer to P78 [List of annotations].

## ➤ Integrated simple motion setup tool

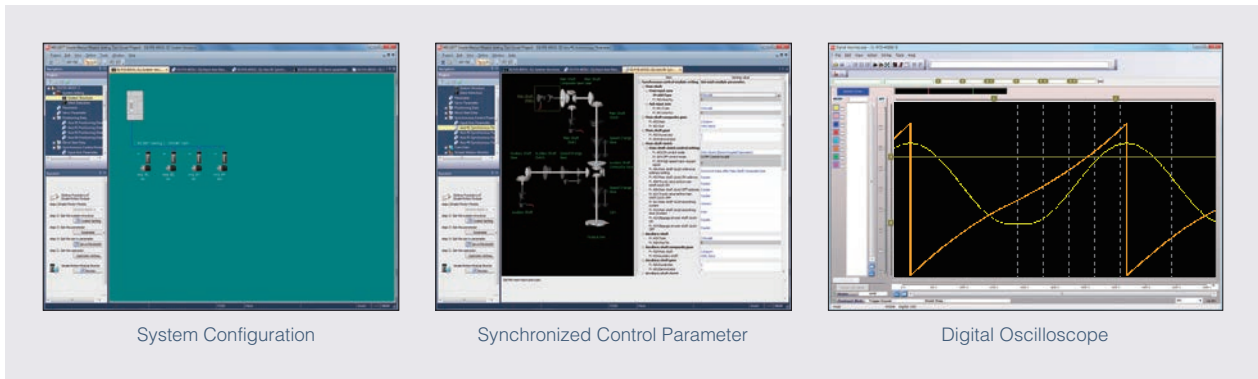

- The simple motion setup tool is integrated in GX Works3.
- GX Works3 makes it easy to change simple motion module settings such as module parameters, positioning data, and servo parameters. It also simplifies the servo adjustment.

## GX LogViewer\*<sup>A13</sup>

### ▶ Allows visualization of collected data and helps improve debugging efficiency

- This tool displays and analyzes large volumes of data collected by the CPU module with easy-to-understand operations.
- It enables the setting of the connection destination using the same operation as the setting and engineering tools, making it easy to check data.
- GX LogViewer is included in GX Works3 and provided free of charge\*<sup>1</sup>.



### ▶ Visualizes logging data

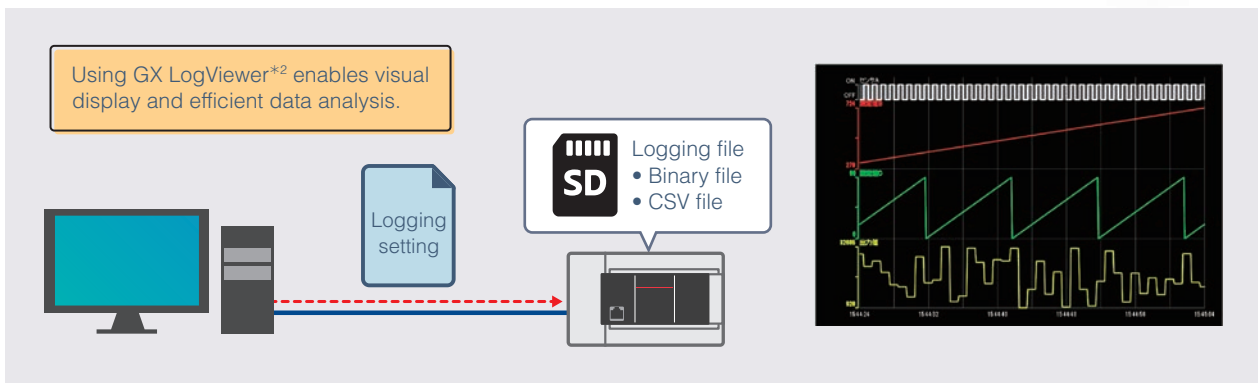

- Logging data collected from CPU modules can be displayed visually for efficient data analysis.

### ▶ Changes in device values can be checked in real time

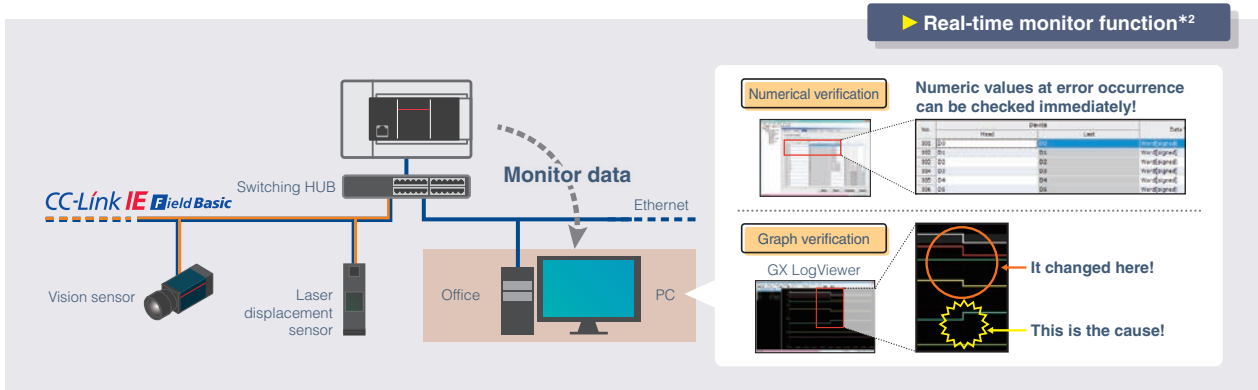

- Specified device values can be monitored in real time at any required interval or timing.
- Changes in device values can be verified numerically or graphically, improving debugging efficiency during troubleshooting.

\*<sup>1</sup>: Please contact your local Mitsubishi Electric sales office or representative.  
 \*<sup>2</sup>: A firmware upgrade may be required to use some functions and modules. For details, refer to appendix P77 [Function compatibility table].

Models with restrictions are marked with symbols such as \*A/\*B/\*C. For details of restrictions, refer to P78 [List of annotations].

## Camera recording package

### Creates recording systems by linking cameras

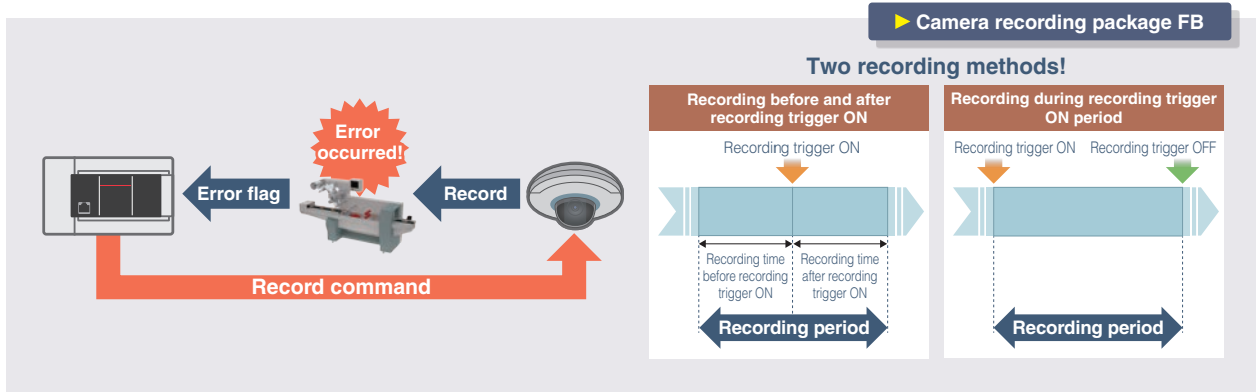

- Video of operating conditions when errors occur can be saved for use during error analysis.
- By using FB, you can easily command the camera to record.
- FB is provided free of charge\*.

### Analysis with video of device error points

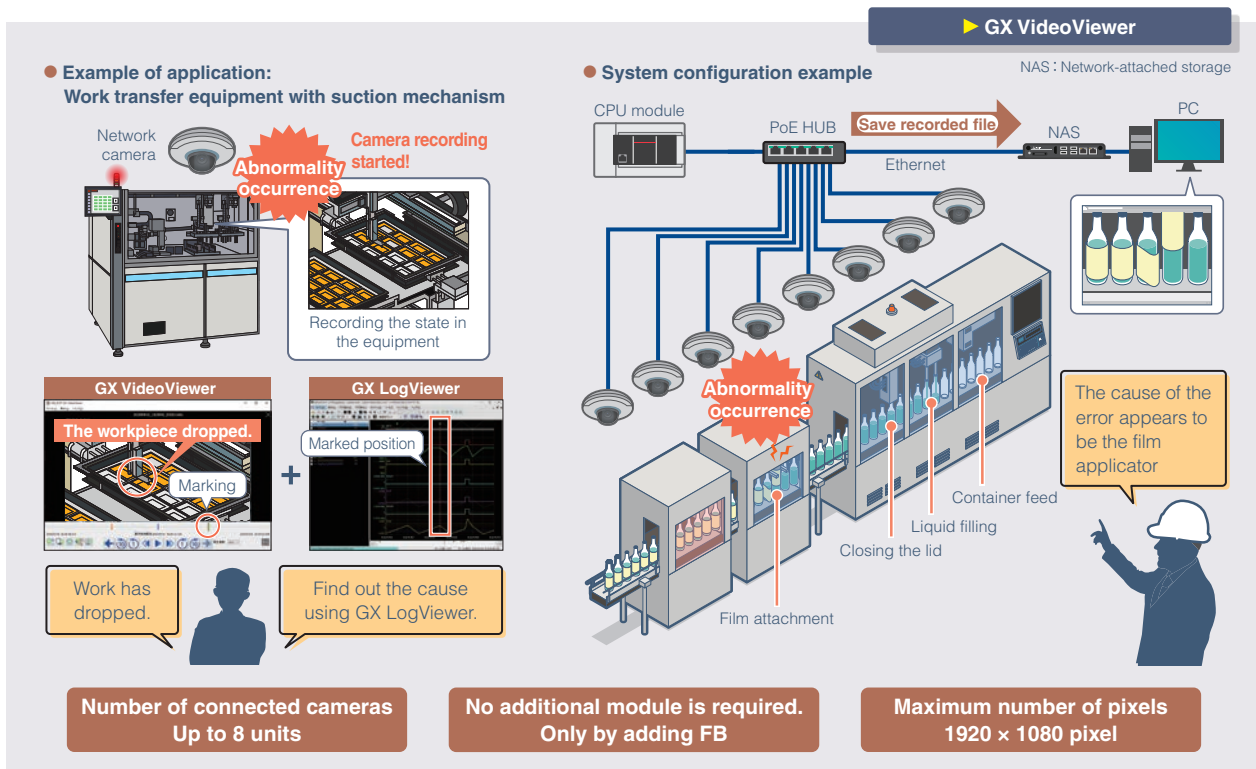

- Video files can be played back in GX VideoViewer.
- Marked points of interest in the video can be shared with GX LogViewer and GX Works3 to track down the causes of problems.
- GX VideoViewer is provided free of charge\*.

\*: Please contact your local Mitsubishi Electric sales office or representative.

Models with restrictions are marked with symbols such as \*A/\*B/\*C. For details of restrictions, refer to P78 [List of annotations].

## MELSOFT Library useful for reducing man-hours

For details, refer to the guide on the right.  
L(NA)08475ENG



### FB makes programs easy to read

- FB stands for “function block”, and indicates a sequence program made into a circuit block part used repeatedly.
- This leads to more efficient program development and fewer program errors.

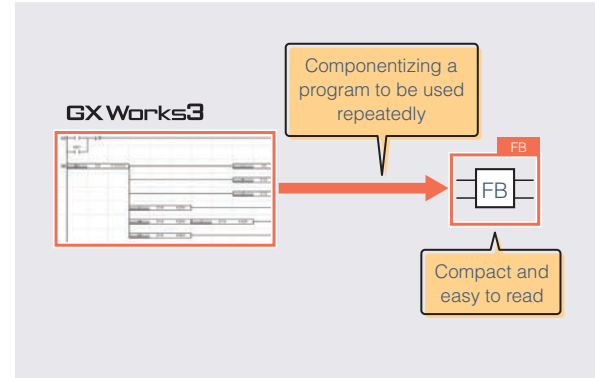

### These are great advantages of FB!

#### Programs can be easily diverted

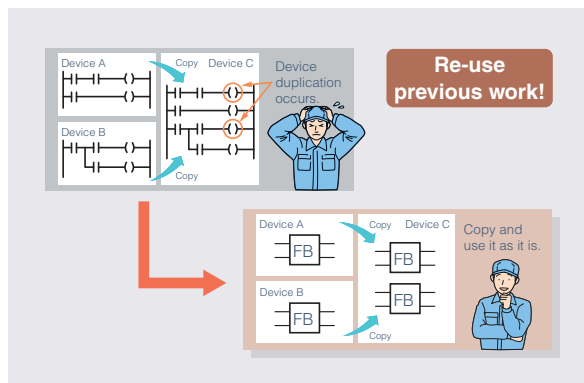

- In program (processing) management, programs can be easily diverted by dragging & dropping FBs.

#### Increased program readability

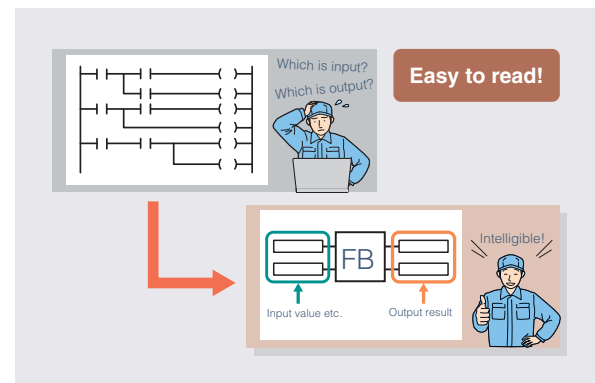

- In FB, only the necessary input/output are displayed, so the appearance is simple and programs are easier to read.

#### Module FBs to control each module are available

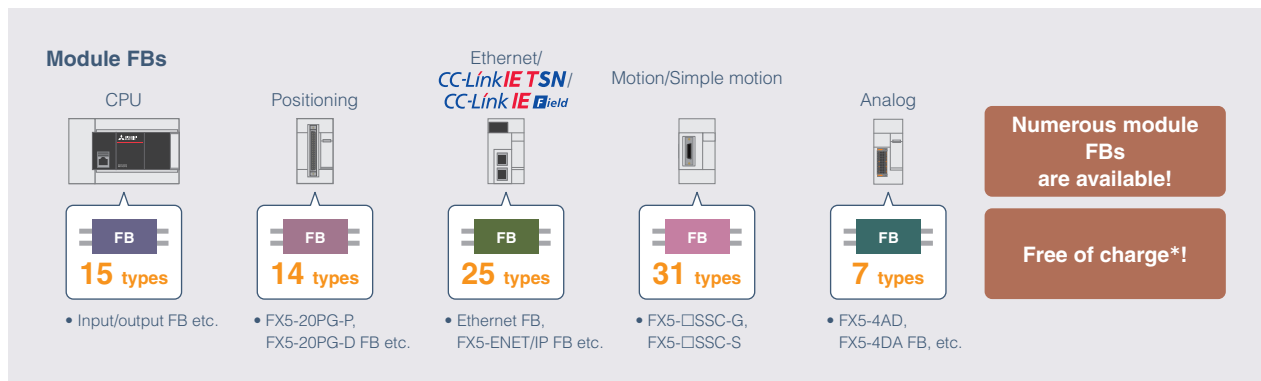

- Using the module FBs eliminates the need for programming the processing of each module and reduces programming man-hours.
- Module FBs are included in GX Works3 in advance. In addition, many module FBs are free of charge\*. Helps reduce programming development man-hours.

\*: Please contact your local Mitsubishi Electric sales office or representative.

Models with restrictions are marked with symbols such as \*A/\*B/\*C. For details of restrictions, refer to P78 [List of annotations].

CPU Performance  
Analog Control  
Positioning Control  
High-speed Counter Control  
Network/Communication/Information-sharing  
Safety Control  
Programming Environment

memo



# Programming Software

## MELSOFT *iQ* Works

MELSOFT iQ Works is based on the system management software MELSOFT Navigator, and includes each engineering software (GX Works2/GX Works3, MT Works2, GT Works3, RT ToolBox3 mini, FR Configurator2).

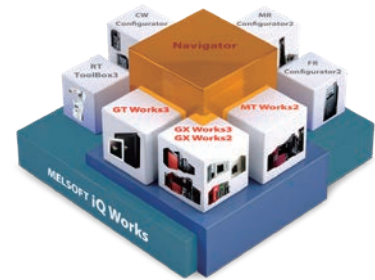

### MELSOFT iQ Works FA Integrated Engineering Software\*1

iQ Works (English version) ..... Model: SW2DND-IQWK-E (DVD)

### MELSOFT GX Works3 PLC Engineering Software\*1

GX Works3 (English version) ..... Model: SW1DND-GXW3-E (DVD)

### ➤ Corresponding models

**GX Works3 software**

**FX5S, FX5UJ, FX5U, FX5UC**

**GX Works2 software\*2**

**FX3U, FX3UC, FX3G, FX3GC, FX3S**

## GX Works2

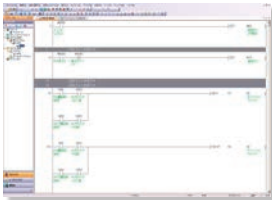

Reading



## GX Works3

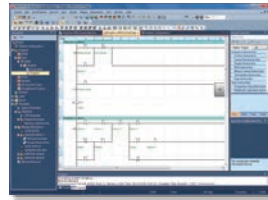

Programs created with GX Works2 can be used with GX Works3. They can also be used as programs for the MELSEC iQ-F series.

A special catalog (separate booklet) of MELSOFT iQ Works is available. (Functions shown in the catalog vary according to PLC model.)  
For details, refer to the following catalog:  
"Mitsubishi iQ Platform Compatible FA Integrated Engineering Software MELSOFT iQ Works" L(NA)08232ENG



\*1: GX Works2 is also enclosed.  
\*2: For the models compatible with each software, refer to the manual for each product.

Models with restrictions are marked with symbols such as \*A/\*B/\*C. For details of restrictions, refer to P78 [List of annotations].



# e-F@ctory Starter Package

For details of e-F@ctory Starter Package, refer to the leaflet on the right. E001ENG



## ➤ Easily analyze equipment information

**IoT can be utilized on production sites!**

**e-F@ctory Starter Package**

**What is the e-F@ctory Starter Package?** An example of a project that enables easy analysis of equipment information integrated in the programmable controller, and displays the analysis result on the GOT.

- Offered free-of-charge as sample projects that can be introduced easily\*.
- Offers many functions for data collection, visualization, simple analysis, etc. on the production site level.
- Can be introduced easily only by device assignment and parameter setting.

## ➤ Easy introduction of IoT by “Visualization Diagnosis”

**Equipment total efficiency monitor**

- The defective product occurrence ratio and equipment stop ratio can be visualized.
- It is possible to shift from the equipment total efficiency monitor screen to each function screen. The detailed situation can be checked on each function screen.

## ➤ Predictive maintenance by MELSEC iQ-F

**MT method**

Screen for calculating MD from signal data → MT method MD graph display screen

**What is the MT method?** A multivariate analysis technique to which the Mahalanobis distance used in statistical analysis is applied.

- For example, by monitoring the temperature and vibration of the device using the MT method, an “unusual state” can be detected and unexpected failures can be prevented beforehand.
- The defect occurrence trend is detected, and prevention of defect occurrence is supported.

## ➤ Simple analysis by “Data collection Visualization”

**Cylinder & cycle time measurement monitor**

- It is possible to visualize the alarm occurrence status, and whether or not the operation time exceeds the threshold value.
- The maintenance timing can be grasped before the production efficiency decreases, and preventive maintenance is enabled.

## ➤ Capable of detecting abnormal waveform fluctuations that are difficult to determine

**Waveform guard band monitor**

- Waveform shapes of analog waveform data such as current and temperature can be monitored.
- Abnormal waveform fluctuation can be detected, which is difficult with basic threshold monitor using upper and lower limit value monitor.

\*: For sample screens and projects, please contact your local Mitsubishi Electric sales office or representative.

Models with restrictions are marked with symbols such as \*A/\*B/\*C. For details of restrictions, refer to P78 [List of annotations].

# PackML

## Supports for PackML compliance with international standards

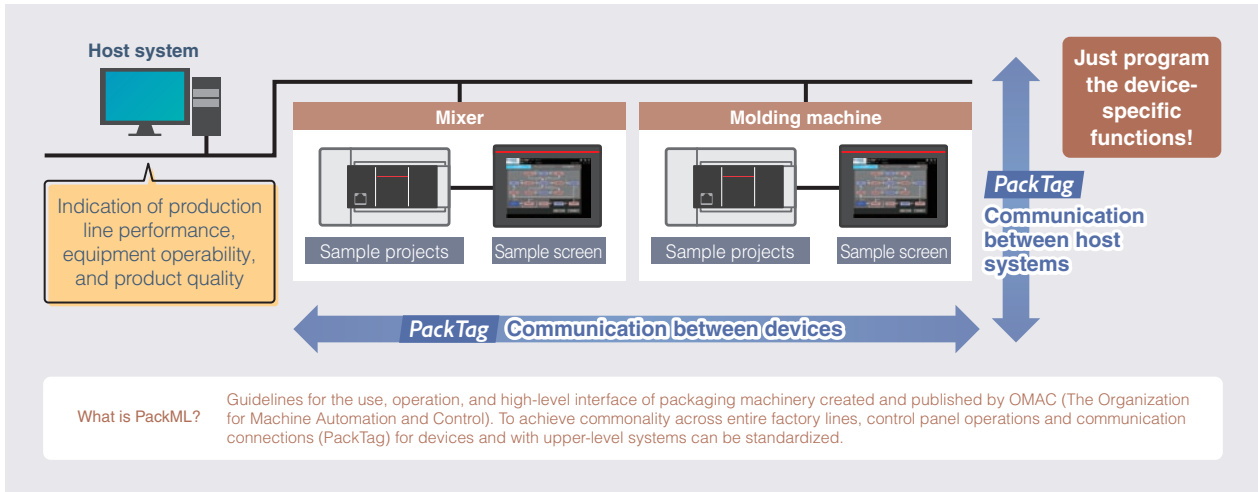

- Sample screens and sample projects that are compliant with international standards are provided free of charge\*.
- Sample screens and projects can be used to reduce the man-hours and time needed for program development.
- Even if manufacturers of equipment differ, monitor and control screens and operability can be standardized across entire lines, facilitating improved operation and maintenance.
- Standardized connections between devices and with host systems reduce start-up time.

## Example of a free GOT sample screen

● Monitor and control screen

● Alarm and event screen/OEE screen (comprehensive facility efficiency monitor)

No.	Occur date	Alarm ID	Alarm message
1	2022/08/21 11:23:42	9	Emergency stop button was pressed
2	2022/08/21 11:23:42	1	Safety door open
3	2022/08/21 11:23:42	2	Stop button was pressed
4	2022/08/21 11:23:42	3	Air pressure is low
5	2022/08/21 11:23:42	4	The voltage is low
6	2022/08/21 11:23:42	5	Oil pressure has dropped
7	2022/08/21 11:23:42	6	Material is decreasing
8	2022/08/21 11:23:42	7	Production speed is declining
9	2022/08/21 11:23:42	8	Line speed change requested
10	2022/08/21 11:23:42	9	Production started

\*: For sample screens and projects, please contact your local Mitsubishi Electric sales office or representative.

Models with restrictions are marked with symbols such as \*A/\*B/\*C. For details of restrictions, refer to P78 [List of annotations].

# Function compatibility table

Function		Supported CPU module firmware version			Supported engineering tool software version		
		FX5S	FX5UJ	FX5U/FX5UC	FX5S	FX5UJ	FX5U/FX5UC
SLMP Communication	3E frame	From the first	From the first	From the first	GX Works3: 1.080J or later	GX Works3: 1.060N or later	From the first
	1E frame	From the first	1.030 or later	1.210 or later	GX Works3: 1.080J or later	GX Works3: 1.085P or later	—
CC-Link IE Field Network Basic		From the first	From the first	1.040 or later	GX Works3: 1.080J or later	GX Works3: 1.060N or later	GX Works3: 1.030G or later
Data logging function		From the first*2	From the first	1.040 or later Serial number 16Y***** or later	GX Works3: 1.080J or later (CPU module logging setting tool: 1.124E or later) (GX LogViewer: Ver. 1.124E or later)	GX Works3: 1.060N or later (CPU module logging setting tool: 1.100E or later) (GX LogViewer: Ver. 1.100E or later)	GX Works3: 1.030G or later (CPU module logging setting tool: 1.64S or later) (GX LogViewer: Ver. 1.64S or later)
				1.210 or later Serial number 17X***** or later*1	GX Works3: 1.080J or later (CPU module logging setting tool: 1.130L or later) (GX LogViewer: Ver. 1.130L or later)	GX Works3: 1.085P or later (CPU module logging setting tool: 1.130L or later) (GX LogViewer: Ver. 1.130L or later)	GX Works3: 1.065T or later (CPU module logging setting tool: 1.106K or later) (GX LogViewer: Ver. 1.106K or later)
IP filter function		From the first	From the first	1.050 or later	GX Works3: 1.080J or later	GX Works3: 1.060N or later	GX Works3: 1.035M or later
Parallel link function		From the first		1.050 or later	GX Works3: 1.080J or later		GX Works3: 1.035M or later
File transfer function	FTP server		From the first*2	1.040 or later Serial number 16Y***** or later	GX Works3: 1.080J or later	GX Works3: 1.085P or later	GX Works3: 1.030G or later
	FTP Client	Sending file		1.210 or later Serial number 17X***** or later*1	GX Works3: 1.080J or later		GX Works3: 1.065T or later
		Getting file		1.240 or later Serial number 17X***** or later*1	GX Works3: 1.080J or later		GX Works3: 1.075D or later
Backup/restore function		Device/ label data	From the first	1.045 or later Serial number 16Y***** or later	GX Works3: 1.080J or later	GX Works3: 1.060N or later	—
		Data memory		1.050 or later Serial number 16Y***** or later	GX Works3: 1.080J or later		GX Works3: 1.035M or later
Memory dump function		From the first*2	From the first	1.050 or later Serial number 16Y***** or later	GX Works3: 1.080J or later	GX Works3: 1.060N or later	GX Works3: 1.035M or later
Real-time monitor function		From the first		1.060 or later	GX Works3: 1.080J or later (GX LogViewer: Ver. 1.124E or later)		GX Works3: 1.060N or later (GX LogViewer: Ver. 1.100E or later)
Web Server function	System Web page		From the first	1.060 or later	GX Works3: 1.080J or later	GX Works3: 1.060N or later	GX Works3: 1.040S or later
	User Web page						
Simple CPU communication function		From the first	From the first	1.110 or later Serial number 17X***** or later*1	GX Works3: 1.080J or later	GX Works3: 1.060N or later	GX Works3: 1.050C or later
		Communication counterpart device addition	From the first	1.030 or later	1.210 or later	GX Works3: 1.080J or later	GX Works3: 1.085P or later
MODBUS/TCP communication function		From the first	From the first	1.060 or later	GX Works3: 1.080J or later	GX Works3: 1.060N or later	GX Works3: 1.040S or later
Time setting function (SNTP client)				1.060 or later	GX Works3: 1.080J or later	GX Works3: 1.060N or later	GX Works3: 1.040S or later
Firmware update function using engineering tools		From the first	—	—	GX Works3: 1.080J or later	—	—

\*1: Supported by serial number 178\*\*\*\*\* for FX5UC-32MT/DS-TS and FX5UC-32MT/DSS-TS or later.  
\*2: Requires the SD memory card module, sold separately.

Models with restrictions are marked with symbols such as \*A/\*B/\*C. For details of restrictions, refer to P78 [List of annotations].

# List of annotations

Annotation No.	Item	Content
<b>■ Content about versions</b>		
*A	1	Unicode character string FX5UJ: Supported in firmware Ver. 1.030 or later. In addition, GX Works3 Ver. 1.085P or later is required. FX5U/FX5UC: Supported in firmware Ver. 1.240 or later. In addition, GX Works3 Ver. 1.075D or later is required.
	2	Sequential function chart (SFC) FX5U/FX5UC: Supported in firmware Ver. 1.220 or later. In addition, GX Works3 Ver. 1.070Y or later is required.
	3	Program capacity (128 k steps)
	4	No. of input/output points (384 points)
	5	No. of remote I/O points (512 points)
	6	Device/label memory (standard area) Capacity expansion FX5U/FX5UC: Supported in firmware Ver. 1.210 or later. In addition, GX Works3 Ver. 1.065T or later is required.
	7	Improved operability of user Web drawing tool Supported in user Web drawing tool Ver. 1.01B or later.
	8	Expanded the number of remote I/O stations for CC-Link IE Field Network Basic from 6 to 16 FX5U/FX5UC: Supported in firmware Ver. 1.110 or later and serial number 17X**** (serial number 178**** for FX5UC-32MT/DS-TS and FX5UC-32MT/DSS-TS) or later. In addition, GX Works3 Ver. 1.050C or later is required. FX5U/FX5UC: Up to 6 stations with firmware versions before 1.110.
	9	EtherNet/IP Configuration Tool for FX5-ENET/IP Japanese version supported EtherNet/IP Configuration Tool for FX5-ENET/IP: Supported in Ver. 1.01B or later.
	10	EtherNet/IP Configuration Tool for FX5-ENET/IP can be started from GX Works3 screen EtherNet/IP Configuration Tool for FX5-ENET/IP: Supported in Ver. 1.00A or later. In addition, GX Works3 Ver. 1.085P or later is required.
	11	Parameter settings of the FX5-OPC FX5U/FX5UC: Supported in firmware Ver. 1.245 or later. In addition, GX Works3 Ver. 1.077F or later is required.
	12	OPC UA Module Configuration Tool FX5U/FX5UC: Supported in OPC UA Module Configuration Tool Ver. 1.00A or later. In addition, GX Works3 Ver. 1.077F or later is required.
	13	GX LogViewer FX5S: Supported in GX LogViewer Ver. 1.124E or later.
	14	Guidance flow function GX Works3: Ver. 1.085P or later is required.
<b>■ Content about specifications</b>		
*B	1	CPU module Frequency FX5S: 100 kpps FX5UJ: 200 kpps FX5U/FX5UC: 200 kpps
	2	Built-in positioning function Number of connected axes FX5S: max. 4 axes FX5UJ: max. 3 axes FX5U/FX5UC: max. 4 axes
	3	High-speed Counter Function FX5S/FX5UJ: 4 ch 100 kHz + 4 ch 10 kHz For FX5U-32M and FX5UC-32M only: 6 ch 200 kHz + 2 ch 10 kHz
	4	Synchronous control FX5-40SSC-S: Up to 64 types of cam patterns can be registered
<b>■ Content about network configuration</b>		
*C	1	CPU module CC-Link IE Field Network Basic master station function FX5U/FX5UC CPU module: Up to 16 occupied stations in total. FX5S/FX5UJ CPU module: Up to 8 occupied stations in total.
	2	Simple CPU communication function FX5-ENET, FX5-ENET/IP: Up to 32 connections FX5S/FX5UJ CPU module: Up to 8 connections FX5U/FX5UC CPU module: Up to 16 connections
<b>■ Content about options</b>		
*D	1	FX5-30EC Attach when connecting an extension cable type module to a distant location or when making two-tier connections.
	2	FX5-65EC The connector conversion adapter (FX5-CNV-BC) is required when connected with an input/output module (extension cable type), high-speed pulse input/output module, or an intelligent function module. When using also the bus conversion module in the same system, connect the FX5 extension power supply module or the powered I/O module right after the extended extension cable.
<b>■ Other</b>		
*E	1	FX2NC-100MPCB May not be included with some intelligent function modules. For details, refer to the manual.

memo

# FUTURE MANUFACTURING

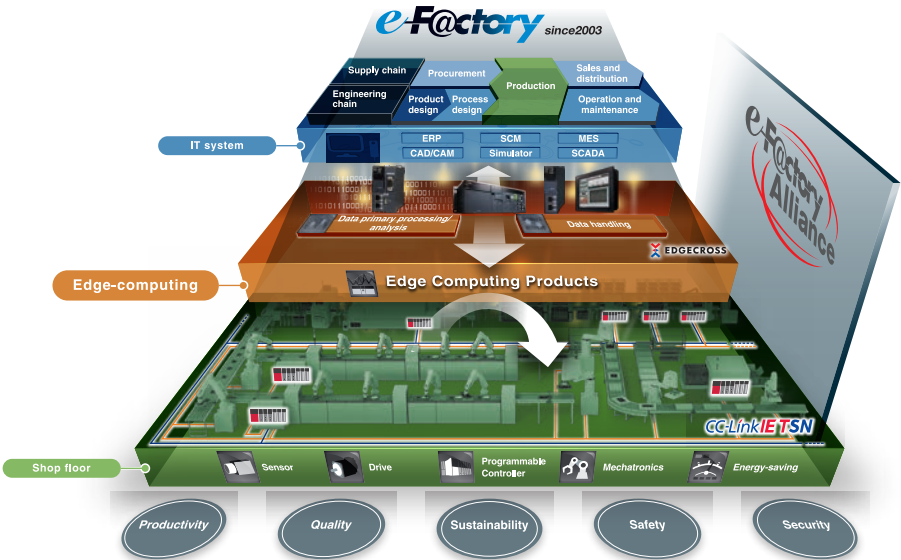

The Future of Manufacturing as envisioned by Mitsubishi Electric, e-F@ctory: "Manufacturing" that evolves in response to environmental changes in an IoT enabled world.

Established In 2003, e-F@ctory created a Kaizen<sup>#1</sup> automation methodology to help optimize and manage the increasingly complex business of "manufacturing". Continuously evolving itself, it also utilizes the expanded reach of IT, which has brought "cyber world" benefits of analysis, simulation and virtual engineering, and yet has also placed greater demands on the "physical" world for increased data sensing, collection and communication. The continued success of e-F@ctory comes from understanding that each manufacturer has individual needs and investment plans but must still deliver; "Reduced management costs" (TCO); production flexibility to make a multitude of product in varying quantities; continuously enhanced quality. In short e-F@ctory's goal is to deliver operational performance that is "a step ahead of the times", while enabling manufacturing to evolve in

response to its environment. To do this it is supported by three key elements:

- The e-F@ctory Alliance Partners; who bring a wide range of software, devices, and system integration skills that enable the creation of the optimal e-F@ctory architecture.
- Advanced communication; utilizing open network technology like CC-Link IE, and communication middleware such as OPC, to open the door to device data, including legacy systems, while supporting high speed extraction.
- Platform thinking; to reduce the number of complex interfaces making it easier to bring together Robotics, Motion, Open programming languages (C language), PACs etc. strengthening the field of control,

yet operating on industrial strength hardware.



Kaizen<sup>#1</sup> = continuous improvement  
 TCO = Total Cost of Ownership

# Table of Contents

<b>Lineup Details/Model Selection</b>	<b>82</b>	<b>1</b>
<b>Safety Control</b>	<b>105</b>	<b>2</b>
<b>I/O Module</b>	<b>109</b>	<b>3</b>
<b>Analog Control</b>	<b>119</b>	<b>4</b>
<b>High-Speed Counter</b>	<b>133</b>	<b>5</b>
<b>Pulse Output/Positioning</b>	<b>139</b>	<b>6</b>
<b>Network/Communication/Information-sharing</b>	<b>151</b>	<b>7</b>
<b>Programming/Development Environment</b>	<b>185</b>	<b>8</b>
<b>Option/Related Products</b>	<b>189</b>	<b>9</b>
<b>Related information</b>	<b>197</b>	<b>10</b>
<b>Overseas Service System/Compatible Products</b>	<b>199</b>	<b>11</b>
<b>Specifications</b>	<b>203</b>	<b>12</b>
<b>Products List</b>	<b>269</b>	<b>13</b>



# Selecting the FX5S model

## ◇ Product configuration

**FX5S**

- Control scale: 30 to 60 points (CPU module: 30/40/60 points)
- Excellent core performance and simple model selection help combine ease of use and simplicity into a single unit.

\* For details about the connection positions, refer to the manual.

Type	Details	Connection details, model selection
<b>1</b> CPU module	PLC with built-in CPU, power supply, input/output and program memory.	Various extension devices can be connected.
<b>2</b> FX5 expansion board	Board connected to front of CPU module to expand functions.	Up to 1 SD memory card module and 1 communication board (up to 2 modules in total) can be connected to the front of the CPU module. (Expansion adapter can also be used.)
<b>3</b> FX5 expansion adapter	Adapter connected to left side of CPU module to expand functions.	Up to 2 communication adapters and up to 4 analog adapters* (up to 6 adapters in total) can be connected to the left side of CPU module. When <b>2</b> is used, the number of units is restricted.

\*: For FX5-4A-ADP with a serial number 223\*\*\*\* or older, up to two modules can be connected in the entire system.

### 1 CPU module (AC power supply/DC input type)

Model	Function	Input/output points occupied	Power supply capacity	I/O type	No. of input points	No. of output points	
			24 V DC service power supply				
FX5S-30MR/ES	CPU module (With built-in 24 V DC service power supply)	30 points	400 mA*	DC input (sink/source)/relay output	16 points	14 points	
FX5S-30MT/ES				DC input (sink/source)/transistor (sink)			
FX5S-30MT/ESS				DC input (sink/source)/transistor (source)			
FX5S-40MR/ES		40 points		400 mA*	DC input (sink/source)/relay output	24 points	16 points
FX5S-40MT/ES					DC input (sink/source)/transistor (sink)		
FX5S-40MT/ESS					DC input (sink/source)/transistor (source)		
FX5S-60MR/ES		60 points		400 mA*	DC input (sink/source)/relay output	36 points	24 points
FX5S-60MT/ES					DC input (sink/source)/transistor (sink)		
FX5S-60MT/ESS					DC input (sink/source)/transistor (source)		

\*: Use as power supply for input devices. (Cannot be used as an external power supply for expansion adapters.)

### 2 FX5 expansion board

Model	Function	Number of occupied input/output points	Current consumption	
			5 V DC power supply*1	24 V DC power supply
FX5-232-BD	RS-232C communication	—	— (20 mA)	—
FX5-485-BD	RS-485 communication			
FX5-422-BD-GOT	RS-422 communication (for GOT connection)			
FX5-SDCD	SD memory card module			

\*1: Current consumption calculation is not required for the FX5S CPU module. Values in parentheses are values stated in the specifications of each product.

\*2: The current consumption will increase when the 5 V type GOT is connected.

3 FX5 expansion adapter

Model	Function	Number of occupied input/output points	Current consumption			
			5 V DC power supply*	24 V DC power supply*	External 24 V DC power supply	
FX5-232ADP	RS-232C communication	-	— (30 mA)	— (30 mA)	—	
FX5-485ADP	RS-485 communication		— (20 mA)			
FX5-4A-ADP	2 ch voltage input/current input, 2 ch voltage output/current output		-	— (10 mA)	—	100 mA
FX5-4AD-ADP	4 ch voltage input/current input				— (20 mA)	—
FX5-4AD-PT-ADP	4 ch temperature sensor (resistance temperature detector) input					
FX5-4AD-TC-ADP	4 ch temperature sensor (thermocouple) input					
FX5-4DA-ADP	4 ch voltage output/current output					

\*: Current consumption calculation is not required for the FX5S CPU module. Values in parentheses are values stated in the specifications of each product.

Rules for System Configuration

A maximum of 60 input and output points can be controlled by the FX5S CPU module.

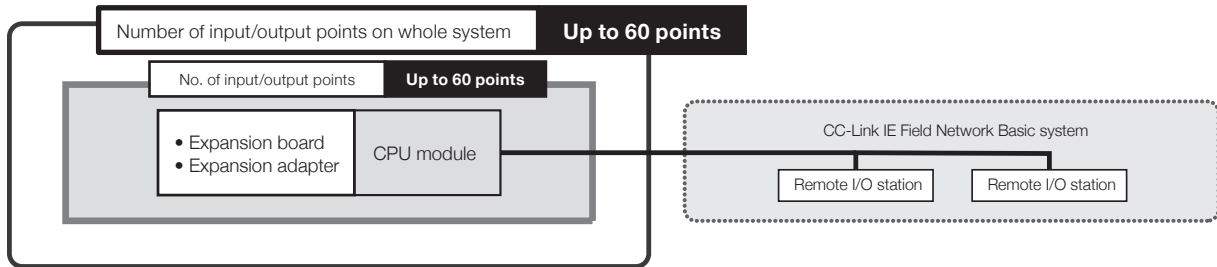

Limitation on number of modules when extending

The number of connectable modules is limited for the following products. For details, refer to the manual.

Type	Model/type	Setting method/precautions
FX5 expansion adapter	FX5-232ADP	Up to 2 modules can be connected for the entire system. When an expansion board (for RS-232C/RS-485/RS-422 communication) is connected to the CPU module, only 1 module can be connected.
	FX5-485ADP	
	FX5-4A-ADP*1	
	FX5-4AD-ADP	Up to 4 modules can be connected for the entire system. For FX5-4A-ADP with a serial number 223**** or older, up to two modules can be connected in the entire system.
	FX5-4DA-ADP	
	FX5-4AD-PT-ADP	
	FX5-4AD-TC-ADP*2	

\*1: When two or more FX5-4DA-ADP are used, and if they are connected adjacent to FX5-4A-ADP with a serial number 223\*\*\*\* or older, connect them only to one side. Do not use both sides.

\*2: When the FX5-4DA-ADP and FX5-4A-ADP are used, and if they are connected adjacent to FX5-4AD-TC-ADP, connect them to either one side. Do not use both sides.

Refer to the manual for details on each model.

# Selecting the FX5UJ model

## ◇ Product configuration



**FX5UJ**

- Control scale: 24 to 256 points (CPU module: 24/40/60 points)
- With as many built-in functions as the FX5U/FX5UC CPU module. Providing excellent cost performance.



\* For details about the connection positions, refer to the manual.

Type	Details	Connection details, model selection
<b>1</b> CPU module	PLC with built-in CPU, power supply, input/output and program memory.	Various extension devices can be connected.
<b>2 4</b> I/O module (extension cable type)	Product for extending I/O of extension cable type. Some products are powered.	The maximum number of input and output points for the entire system is 256 points. Up to 8 extension modules can be connected. (Extension power supply modules and connector conversion modules are not included in the number of connected modules.) Up to 4 high-speed pulse I/O modules can be connected. For details, refer to "Rules for System Configuration" on p. 88.
<b>3</b> FX5 extension power supply module	Module for extending power supply if CPU module's internal power supply is insufficient. Extension cable is enclosed.	Power can be supplied to I/O module, intelligent function module. Up to 1 module can be connected.
<b>5</b> FX5 intelligent function module	Module with functions other than input/output.	Up to 8 extension modules including the I/O module can be connected (Extension power supply modules and connector conversion modules are not included in the number of connected modules.)
<b>6</b> Connector conversion module	Module for connecting FX5 Series (extension connector type) extension module.	An extension module (extension connector type) for FX5 can be connected.
<b>7</b> I/O module (Extension connector type)	Product for adding extension connector type inputs/outputs.	The maximum number of input and output points for the entire system is 256 points. Up to 8 extension modules can be connected. (Extension power supply modules and connector conversion modules are not included in the number of connected modules.) Using this type of I/O module requires the connector conversion module.
<b>8</b> FX5 expansion board	Board connected to front of CPU module to expand functions.	Up to 1 module can be connected to the front of the CPU module. (Expansion adapter can also be used.)
<b>9</b> FX5 expansion adapter	Adapter connected to left side of CPU module to expand functions.	Up to 2 communication adapters and up to 2 analog adapters (up to 4 adapters in total) can be connected on the left side of the CPU module. When <b>8</b> is used, the number is limited.
<b>10</b> FX5 safety extension module	Module for configuring a safety control system.	Up to 1 safety main module and up to 2 safety input extension modules can be connected. Extension modules cannot be connected on the subsequent stage (the right side) of the safety extension module.

### 1 CPU module (AC power supply, DC input type)

Model	Function	Number of occupied input/output points	Power supply capacity	I/O type	No. of input points	No. of output points
			24 V DC service power supply			
FX5UJ-24MR/ES	CPU module (24 V DC service power built-in)	24 points (32 points)*1	400 mA (460 mA*2)	DC input (sink/source)/relay output	14 points (16 points)*1	10 points (16 points)*1
FX5UJ-24MT/ES				DC input (sink/source)/transistor (sink)		
FX5UJ-24MT/ESS				DC input (sink/source)/transistor (source)		
FX5UJ-40MR/ES		40 points	400 mA (500 mA*2)	DC input (sink/source)/relay output	24 points	16 points
FX5UJ-40MT/ES				DC input (sink/source)/transistor (sink)		
FX5UJ-40MT/ESS				DC input (sink/source)/transistor (source)		
FX5UJ-60MR/ES		60 points (64 points)*1	400 mA (550 mA*2)	DC input (sink/source)/relay output	36 points (40 points)*1	24 points
FX5UJ-60MT/ES				DC input (sink/source)/transistor (sink)		
FX5UJ-60MT/ESS				DC input (sink/source)/transistor (source)		

\*1: The number in parentheses represents occupied points. Use the value in parentheses to calculate the total number of input/output points.  
 \*2: Power supply capacity when an external power supply is used for input circuits.

**2 I/O module (AC power supply/DC input type) (extension cable type)**

Model	Function	Number of occupied input/output points	Power supply capacity		I/O type	No. of input points	No. of output points
			5 V DC power supply	24 V DC service power supply			
FX5-32ER/ES	I/O module (24 V DC service power built-in)	32 points	965 mA	250 mA (310 mA*)	DC input (sink/source)/relay output	16 points	16 points
FX5-32ET/ES					DC input (sink/source)/transistor (sink)		
FX5-32ET/ESS					DC input (sink/source)/transistor (source)		

\*: Power supply capacity when an external power supply is used for input circuits.

**3 FX5 extension power supply module**

Model	Function	Number of occupied input/output points	Power supply capacity	
			5 V DC power supply	24 V DC power supply
FX5-1PSU-5V	Extension power supply	—	1200 mA*	300 mA*

\*: Derating occurs when the ambient temperature exceeds 40°C. For details, refer to the manual.

**4 I/O module (extension cable type)**

Model	I/O type	Number of occupied input/output points	Current consumption	
			5 V DC power supply	24 V DC power supply
FX5-8EX/ES	DC input (sink/source)	8 points	75 mA	50 mA (0 mA* <sup>1</sup> )
FX5-16EX/ES	DC input (sink/source)	16 points	100 mA	85 mA (0 mA* <sup>1</sup> )
FX5-8EYR/ES	Relay output	8 points	75 mA	75 mA
FX5-8EYT/ES	Transistor output (sink)			
FX5-8EYT/ESS	Transistor output (source)			
FX5-16EYR/ES	Relay output	16 points	100 mA	125 mA
FX5-16EYT/ES	Transistor output (sink)			
FX5-16EYT/ESS	Transistor output (source)			
FX5-16ER/ES	DC input (sink/source)/relay output	16 points	100 mA	125 mA (85 mA* <sup>1</sup> )
FX5-16ET/ES	DC input (sink/source)/transistor output (sink)			
FX5-16ET/ESS	DC input (sink/source)/transistor output (source)			
FX5-16ET/ES-H* <sup>2</sup>	DC input (sink/source)/transistor output (sink)	16 points	100 mA	125 mA (85 mA* <sup>1</sup> )
FX5-16ET/ESS-H* <sup>2</sup>	DC input (sink/source)/transistor output (source)			

\*1: Current consumption when an external power supply is used for input circuits.

\*2: Supported by FX5UJ CPU module Ver. 1.030 or later.

**5 FX5 intelligent function module**

Model	Function	Number of occupied input/output points	Current consumption		
			5 V DC power supply	24 V DC power supply	24 V DC external power supply
FX5-4AD	4-ch voltage/current input	8 points	100 mA	40 mA	—
FX5-4DA	4-ch voltage/current output	8 points	100 mA	—	150 mA
FX5-8AD	8-ch voltage/current/thermocouple/resistance temperature detector input	8 points	—	40 mA	100 mA
FX5-4LC	4-ch temperature control (thermocouple/resistance temperature detector/micro voltage)	8 points	140 mA	—	25 mA
FX5-20PG-P	Pulse output for 2-axis control (transistor output)	8 points	—	—	120 mA
FX5-20PG-D	Pulse output for 2-axis control (differential driver output)	8 points	—	—	165 mA
FX5-40SSC-S	Simple motion 4-axis control (SSCNET III/H compatible)	8 points	—	—	250 mA
FX5-80SSC-S	Simple motion 8-axis control (SSCNET III/H compatible)	8 points	—	—	250 mA
FX5-CCLGN-MS* <sup>1</sup>	CC-Link IE TSN master/local	8 points	—	—	220 mA
FX5-ENET	Ethernet communication	8 points	—	110 mA	—
FX5-ENET/IP	EtherNet/IP communication, Ethernet communication	8 points	—	110 mA	—
FX5-CCL-MS	CC-Link system master/intelligent device station	8 points* <sup>2</sup>	—	—	100 mA
FX5-CCLIEF	CC-Link IE Field Network intelligent device station	8 points	10 mA	—	230 mA
FX5-ASL-M	AnyWireASLINK system master	8 points	200 mA	—	100 mA* <sup>3</sup>
FX5-DP-M	PROFIBUS-DP master	8 points	—	150 mA	—

\*1: Supported by FX5UJ CPU module Ver. 1.040 or later.

\*2: When using FX5-CCL-MS as a master station, the number of remote I/O points on the network increases.

\*3: This value does not include the supply current to remote modules (Max. 2 A).

**6 Connector conversion module**

Model	Function	Number of occupied input/output points	Current consumption	
			5 V DC power supply	24 V DC power supply
FX5-CNV-IF	Connector conversion (FX5 (Extension cable type) → FX5 (Extension connector type))	—	—	—

## 7 I/O module (Extension connector type)

Model	I/O type	Number of occupied input/output points	Current consumption	
			5 V DC power supply	24 V DC power supply
FX5-C16EX/D	DC input (sink)	16 points	100 mA	65 mA (0 mA*)
FX5-C16EX/DS	DC input (sink/source)			
FX5-C32EX/D	DC input (sink)	32 points	120 mA	130 mA (0 mA*)
FX5-C32EX/DS	DC input (sink/source)			
FX5-C32EX/DS-TS				
FX5-C16EYT/D	Transistor output (sink)	16 points	100 mA	100 mA
FX5-C16EYT/DSS	Transistor output (source)			
FX5-C16EYR/D-TS	Relay output			
FX5-C32EYT/D	Transistor output (sink)	32 points	120 mA	200 mA
FX5-C32EYT/DSS	Transistor output (source)			
FX5-C32EYT/D-TS	Transistor output (sink)			
FX5-C32EYT/DSS-TS	Transistor output (source)			
FX5-C32ET/D	DC input (sink)/transistor output (sink)	32 points	120 mA	165 mA (100 mA*)
FX5-C32ET/DSS	DC input (sink/source)/transistor output (source)			
FX5-C32ET/DS-TS	DC input (sink/source)/transistor output (sink)			
FX5-C32ET/DSS-TS	DC input (sink/source)/transistor output (source)			

\*: Current consumption when an external power supply is used for the input circuits.

## 8 FX5 expansion board

Model	Function	Number of occupied input/output points	Current consumption	
			5 V DC power supply*1	24 V DC power supply
FX5-232-BD	RS-232C communication	—	— (20 mA)	—
FX5-485-BD	RS-485 communication			
FX5-422-BD-GOT	RS-422 communication (for GOT connection)			

\*1: Current consumption calculation is not required for the FX5UJ CPU module. Shown in parentheses are values stated in the specifications of each product.

\*2: The current consumption will increase when the 5 V type GOT is connected.

## 9 FX5 expansion adapter

Model	Function	Number of occupied input/output points	Current consumption		
			5 V DC power supply*1	24 V DC power supply*1	24 V DC external power supply
FX5-232ADP	RS-232C communication	—	— (30 mA)	— (30 mA)	—
FX5-485ADP	RS-485 communication		— (20 mA)		
FX5-4A-ADP*2	2 ch voltage input/current input, 2 ch voltage output/current output		—	100 mA	
FX5-4AD-ADP	4 ch voltage input/current input		— (10 mA)	— (20 mA)	160 mA
FX5-4AD-PT-ADP	4 ch temperature sensor (resistance temperature detector) input				
FX5-4AD-TC-ADP	4 ch temperature sensor (thermocouple) input				
FX5-4DA-ADP	4 ch voltage output/current output				

\*1: Current consumption calculation is not required for the FX5UJ CPU module. Shown in parentheses are values stated in the specifications of each product.

\*2: Supported by FX5UJ CPU modules Ver. 1.010 or later.

## 10 FX5 safety extension module

Model	Function	Number of occupied input/output points	Current consumption		
			5 V DC power supply	24 V DC power supply	24 V DC external power supply
FX5-SF-MU4T5*1*2	Safety main module 4-points safety input/4-points safety output	8 points	200 mA	5 mA	125 mA
FX5-SF-8DI4*2	Safety input expansion module 8-points safety input	0 points	—	—	125 mA*3

\*1: Locate these modules on the rightmost side of the system configuration. However, this does not apply when the safety input extension module is connected. They cannot be used together with the bus conversion module or FX3 extension module.

\*2: Supported by FX5UJ CPU modules Ver. 1.010 or later.

\*3: Supplied from external 24 V DC power supply of the FX5-SF-MU4T5.

### Limitation on the number of modules connected to the CPU module

There is a limitation on the number of extension modules connected to the CPU module, as shown on the right.

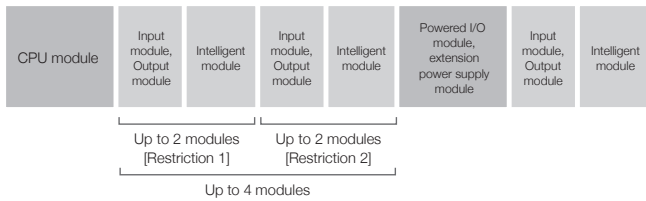

#### [Restriction 1]

- Up to 2 modules can be connected.
- The total number of the input/output points occupied by the extension modules must be 32 or less.
- When 32 input/output points are occupied by the first module, the [Restriction 2] shall apply to the connection of the second and following modules.

#### [Restriction 2]

- Up to 2 modules can be connected.
- If one extension module is connected, 200 mA of 24 V DC service power supply will be consumed unconditionally.
- If the 24 V DC service power supply is insufficient, such as external power for the extension module is supplied from the 24 V DC service power supply of the CPU module, the extension module cannot be connected.

### Calculation of current consumed by extension modules

The power required for the expansion adapter, expansion board and extension module is supplied from the CPU module or extension power supply module. Use the following calculations to confirm whether the required power can be supplied. (All calculations must be satisfied.)

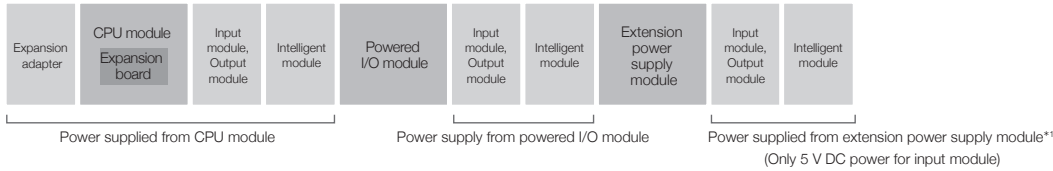

#### ■ Power supply from CPU module

##### [24 V DC power supply]

$$24 \text{ V DC service power supply capacity (CPU module)} - \text{Total current consumption (Total no. of extension devices to be connected)} = \text{Calculation results} \geq 0 \text{ mA}^{*2}$$

#### ■ Power supply from powered I/O module

##### [5 V DC power supply]

$$5 \text{ V DC power supply capacity (Powered I/O module)} - \text{Total current consumption (Total no. of extension devices to be connected)} = \text{Calculation results} \geq 0 \text{ mA}$$

##### [24 V DC power supply]

$$24 \text{ V DC service power supply capacity (Powered I/O module)} - \text{Total current consumption (Total no. of extension devices to be connected)} = \text{Calculation results} \geq 0 \text{ mA}^{*2}$$

#### ■ Power supply from extension power supply module

##### [5 V DC power supply]

$$5 \text{ V DC power supply capacity (Extension power supply module)} - \text{Total current consumption (Total no. of extension devices to be connected)} = \text{Calculation results} \geq 0 \text{ mA}$$

##### [24 V DC power supply]

$$24 \text{ V DC power supply capacity (Extension power supply module)} - \text{Total current consumption (Total no. of extension devices to be connected)} = \text{Calculation results} \geq 0 \text{ mA}$$

**<Cautions>**  
If the calculation results are negative, the power capacity is exceeded so review the system configuration.

\*1: When connecting an input module to the back stage (right side) of the extension power supply module, power will be supplied from the CPU module or a powered I/O module. 5 V DC power is supplied from an extension power supply module.

\*2: The 24 V DC service power calculation results value (when positive) indicates the 24 V DC service power supply's remaining capacity, and can be used as an external load power.

Refer to the next section for the details of some products since the number of connected modules may be limited.

## Rules for System Configuration

The total number of I/O points and remote I/O points for the CPU module and extension devices controllable in FX5UJ CPU module is 256 points or less.

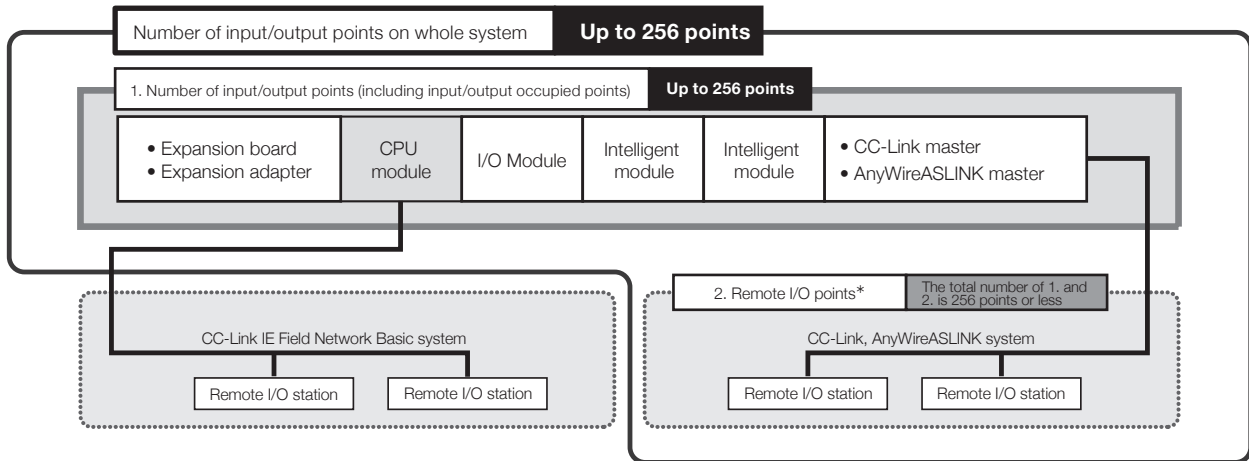

### Number of input/output points

The maximum number of I/O points that can be configured with FX5UJ is as follows.

<b>Maximum number of input/output points</b>	<b>Number of occupied I/O points</b>
<b>256 points</b>	$\text{CPU module (A) points} + \text{I/O module Total (B) points} + \text{Intelligent module (C) modules} \times 8 \text{ points}$
	<small>The number of occupied I/O points does not include those of the expansion adapters, expansion boards, connector conversion modules, and extension power supply modules.</small>

(A): Number of input/output points of CPU module (B): Total number of input/output points of I/O module (C): Total number of intelligent modules

### About remote I/O points

The maximum number of I/O points when using a network master module is as follows.

<b>Maximum number of remote I/O points</b>	<b>Number of occupied remote I/O points*</b>
<b>256 points</b> <small>Number of occupied remote I/O points</small>	$\text{CC-Link (D) points} + \text{AnyWireASLINK (E) points}$

#### (D) Number of CC-Link remote I/O points

<b>Maximum number of CC-Link remote I/O points</b>	<b>Remote I/O points</b>	<b>The total number of remote I/O points in CC-Link</b>
<b>192 points</b>	Number of CC-Link remote I/O points	The total number of remote I/O stations × 32 points
	$\geq$ <input type="text" value="points"/>	$=$ <input type="text" value="stations"/> × 32 points

#### (E) Number of AnyWireASLINK remote I/O points

<b>Maximum number of AnyWire ASLINK remote I/O points</b>	<b>AnyWireASLINK remote I/O points</b>
<b>216 points</b>	Number of remote I/O points assigned to AnyWireASLINK master
	$\geq$ <input type="text" value="points"/>

\*: CC-Link IE Field Network Basic remote I/O stations are not calculated as remote I/O points.



## Limitation on power supply type when connecting

The power supply type is limited for extension modules connectable to the following CPU modules. For details, refer to the manual.

Type/model/power supply type	Connectable extension module	
	Type	Model/power supply type
FX5UJ CPU module	Powered I/O module	FX5-32E□/E□ (AC power supply type)
	Extension power supply module	FX5-1PSU-5V (AC power supply type)

## Limitation on number of modules when extending

The number of connectable modules is limited for the following products. For details, refer to the manual.

Type	Model/type	Setting method/precautions
I/O module (Extension cable type)	FX5-16ET/ES-H	Up to 4 modules can be connected for the entire system.
	FX5-16ET/ESS-H	
FX5 intelligent function module	FX5-CCLGN-MS	Only 1 module can be connected in the entire system for each station type. <ul style="list-style-type: none"> <li>Master station: 1 module</li> <li>Local station: 1 module</li> </ul>
	FX5-CCL-MS	Only 1 module can be connected in the entire system for each station type. <ul style="list-style-type: none"> <li>Master station: 1 module</li> <li>Intelligent device station: 1 module</li> </ul>
	FX5-ENET	Only 1 module can be connected in the entire system.
	FX5-ENET/IP	
	FX5-CCLIEF	
	FX5-DP-M	
	FX5-ASL-M	
		FX5-40SSC-S
	FX5-80SSC-S	Only 1 module may be connected per system. Use together with the FX5-40SSC-S is not possible.
FX5 expansion adapter	FX5-232ADP	Up to 2 modules can be connected for the entire system.
	FX5-485ADP	When an extension board is connected to the CPU module, only 1 module can be connected.
	FX5-4A-ADP	Up to 2 modules can be connected for the entire system.
	FX5-4AD-ADP	
	FX5-4DA-ADP	
	FX5-4AD-PT-ADP	
	FX5-4AD-TC-ADP	
FX5 safety extension module	FX5-SF-MU4T5	Only 1 module of the FX5-SF-MU4T5 and up to 2 modules of the FX5-SF-8DI4 can be connected in the entire system.
	FX5-SF-8DI4	

# Selecting the FX5U model

## ◇ Product configuration

**FX5U**

- Control scale: 32 to 384 points (CPU module: 32/64/80 points)
- Control points up to 512 input/output points, including remote I/O\*

\*: For CC-Link and AnyWireASLINK

\* For details about the connection positions, refer to the manual.

Type	Details	Connection details, model selection
<b>1</b> CPU module	PLC with built-in CPU, power supply, input/output and program memory.	Various extension devices can be connected.
<b>2 4</b> I/O module (extension cable type)	Product for extending I/O of extension cable type. Some products are powered.	The maximum number of input and output points for the entire system is 256 points/384 points*1. Up to 16 extension modules can be connected. (Extension power supply modules and connector conversion modules are not included in the number of connected modules.) Up to 4 high-speed pulse I/O modules can be connected. For details, refer to "Rules for System Configuration" on p. 95.
<b>3</b> FX5 extension power supply module	Module for extending power supply if CPU module's internal power supply is insufficient. Extension cable is enclosed.	Power can be supplied to I/O module, intelligent function module, and bus conversion module. Up to 2 modules can be connected.
<b>5</b> FX5 intelligent function module	Module with functions other than input/output.	Up to 16 extension modules including the I/O module can be connected (Extension power supply modules and connector conversion modules are not included in the number of connected modules.)
<b>6</b> Connector conversion module	Module for connecting FX5 Series (extension connector type) extension module.	An extension module (extension connector type) for FX5 can be connected.
<b>7</b> I/O module (Extension connector type)	Product for adding extension connector type inputs/outputs.	The maximum number of input and output points for the entire system is 256 points/384 points*1. Up to 16 extension modules can be connected. (Extension power supply modules and connector conversion modules are not included in the number of connected modules.) Using this type of I/O module requires the connector conversion module.
<b>8</b> Bus conversion module	Conversion module for connecting FX3 Series extension module.	FX3 extension module can be connected only to the right side of the bus conversion module. When using FX5-CNV-BUSC, a connector conversion module is required.
<b>9</b> FX5 expansion board	Board connected to front of CPU module to expand functions.	Up to 1 module can be connected to the front of the CPU module. (Expansion adapter can also be used.)
<b>10</b> FX5 expansion adapter	Adapter connected to left side of CPU module to expand functions.	Up to 2 communication adapters and up to 4 analog adapters*2 (up to 6 adapters in total) can be connected on the left side of the CPU module.
<b>11</b> FX3 extension power supply module	Module for extending power supply if CPU module's internal power supply is insufficient. Extension cable is enclosed.	Up to 2 modules can be connected. The bus conversion module is required for use.
<b>12</b> FX3 intelligent function module	Module with functions other than input/output.	When using the FX3 extension power supply module, up to 8 modules*3 can be used. When not using the FX3 extension power supply module, up to 6 modules*3 can be used. The bus conversion module is required for use.
<b>13</b> FX5 safety extension module	Module for configuring a safety control system.	Up to 1 safety main module and up to 2 safety input extension modules can be connected. Extension modules cannot be connected on the downstream side (right side) of any safety extension module. Bus conversion modules and FX3 extension modules cannot be used simultaneously.

\*1: Supported by FX5U CPU modules Ver. 1.100 or later and by GX Works3 Ver. 1.047Z or later.  
 \*2: For FX5-4A-ADP with a serial number 223\*\*\*\* or older, up to two modules can be connected in the entire system.  
 \*3: Excluding some models

### 1 -1) CPU module (AC power supply, DC input type)

Model	Function	Number of occupied input/output points	Power supply capacity		I/O type	No. of input points	No. of output points
			5 V DC power supply	24 V DC service power supply			
FX5U-32MR/ES	CPU module (24 V DC service power built-in)	32 points	900 mA	400 mA (480 mA*) [300 mA (380 mA*)]*2	DC input (sink/source)/relay output	16 points	16 points
FX5U-32MT/ES					DC input (sink/source)/transistor (sink)		
FX5U-32MT/ESS					DC input (sink/source)/transistor (source)		
FX5U-64MR/ES		64 points	1100 mA	600 mA (740 mA*) [300 mA (440 mA*)]*2	DC input (sink/source)/relay output	32 points	32 points
FX5U-64MT/ES					DC input (sink/source)/transistor (sink)		
FX5U-64MT/ESS					DC input (sink/source)/transistor (source)		
FX5U-80MR/ES		80 points	1100 mA	600 mA (770 mA*) [300 mA (470 mA*)]*2	DC input (sink/source)/relay output	40 points	40 points
FX5U-80MT/ES					DC input (sink/source)/transistor (sink)		
FX5U-80MT/ESS					DC input (sink/source)/transistor (source)		

\*1: Power supply capacity when an external power supply is used for input circuits.  
 \*2: Value inside [ ] indicates the power supply capacity when the CPU module is used at the operating ambient temperature of less than 0°C.

**1 -2) CPU module (DC power supply/DC input type)**

Model	Function	Number of occupied input/output points	Power supply capacity		I/O type	No. of input points	No. of output points
			5 V DC power supply	24 V DC power supply			
FX5U-32MR/DS	CPU module	32 points	900 mA [775 mA]*	480 mA [360 mA]*	DC input (sink/source)/relay output	16 points	16 points
FX5U-32MT/DS					DC input (sink/source)/transistor output (sink)		
FX5U-32MT/DSS					DC input (sink/source)/transistor output (source)		
FX5U-64MR/DS		64 points	1100 mA [975 mA]	740 mA [530 mA]*	DC input (sink/source)/relay output	32 points	32 points
FX5U-64MT/DS					DC input (sink/source)/transistor output (sink)		
FX5U-64MT/DSS					DC input (sink/source)/transistor output (source)		
FX5U-80MR/DS		80 points	1100 mA [975 mA]	770 mA [560 mA]*	DC input (sink/source)/relay output	40 points	40 points
FX5U-80MT/DS					DC input (sink/source)/transistor output (sink)		
FX5U-80MT/DSS					DC input (sink/source)/transistor output (source)		

\*: Value inside [ ] indicates the power supply capacity when the supply voltage is 16.8 to 19.2 V DC.

**2 -1) I/O module (AC power supply/DC input type) (extension cable type)**

Model	Function	Number of occupied input/output points	Power supply capacity		I/O type	No. of input points	No. of output points
			5 V DC power supply	24 V DC service power supply			
FX5-32ER/ES*1	I/O module (24 V DC service power built-in)	32 points	965 mA	250 mA (310 mA*2)	DC input (sink/source)/relay output	16 points	16 points
FX5-32ET/ES*1					DC input (sink/source)/transistor (sink)		
FX5-32ET/ESS*1					DC input (sink/source)/transistor (source)		

\*1: Can be connected only to the AC power type system

\*2: Power supply capacity when an external power supply is used for input circuits.

**2 -2) I/O module (DC power supply/DC input type) (extension cable type)**

Model	Function	Number of occupied input/output points	Power supply capacity		I/O type	No. of input points	No. of output points
			5 V DC power supply	24 V DC power supply			
FX5-32ER/DS*	I/O module	32 points	965 mA	310 mA	DC input (sink/source)/relay output	16 points	16 points
FX5-32ET/DS*					DC input (sink/source)/transistor output (sink)		
FX5-32ET/DSS*					DC input (sink/source)/transistor output (source)		

\*: Can be connected only to the DC power type system

**3 FX5 extension power supply module**

Model	Function	Number of occupied input/output points	Power supply capacity	
			5 V DC power supply	24 V DC power supply
FX5-1PSU-5V*1	Extension power supply	—	1200 mA*3	300 mA*3
FX5-C1PS-5V*2	Extension power supply	—	1200 mA*3	625 mA*3

\*1: Can be connected only to the AC power type system

\*2: Can be connected only to the DC power type system

\*3: Derating occurs when the ambient temperature exceeds 40°C. For details, refer to the manual.

**4 I/O module (extension cable type)**

Model	I/O type	Number of occupied input/output points	Current consumption	
			5 V DC power supply	24 V DC power supply
FX5-8EX/ES	DC input (sink/source)	8 points	75 mA	50 mA (0 mA*2)
FX5-16EX/ES	DC input (sink/source)	16 points	100 mA	85 mA (0 mA*2)
FX5-8EYR/ES	Relay output	8 points	75 mA	75 mA
FX5-8EYT/ES	Transistor output (sink)			
FX5-8EYT/ESS	Transistor output (source)			
FX5-16EYR/ES	Relay output	16 points	100 mA	125 mA
FX5-16EYT/ES	Transistor output (sink)			
FX5-16EYT/ESS	Transistor output (source)			
FX5-16ER/ES	DC input (sink/source)/relay output	16 points	100 mA	125 mA (85 mA*2)
FX5-16ET/ES	DC input (sink/source)/transistor output (sink)			
FX5-16ET/ESS	DC input (sink/source)/transistor output (source)			
FX5-16ET/ES-H*1	DC input (sink/source)/transistor output (sink)	16 points	100 mA	125 mA (85 mA*2)
FX5-16ET/ESS-H*1	DC input (sink/source)/transistor output (source)			

\*1: Supported by FX5U CPU module Ver. 1.030 or later.

\*2: Current consumption when an external power supply is used for input circuits.

## 5 FX5 intelligent function module

Model	Function	Number of occupied input/output points	Current consumption		
			5 V DC power supply	24 V DC power supply	24 V DC external power supply
FX5-4AD*1	4-ch voltage/current input	8 points	100 mA	40 mA	—
FX5-4DA*1	4-ch voltage/current output	8 points	100 mA	—	150 mA
FX5-8AD*1	8-ch voltage/current/thermocouple/resistance temperature detector input	8 points	—	40 mA	100 mA
FX5-4LC*1	4-ch temperature control (thermocouple/resistance temperature detector/micro voltage)	8 points	140 mA	—	25 mA
FX5-20PG-P*1	Pulse output for 2-axis control (transistor output)	8 points	—	—	120 mA
FX5-20PG-D*1	Pulse output for 2-axis control (differential driver output)	8 points	—	—	165 mA
FX5-40SSC-S	Simple motion 4-axis control (SSCNET III/H compatible)	8 points	—	—	250 mA
FX5-80SSC-S	Simple motion 8-axis control (SSCNET III/H compatible)	8 points	—	—	250 mA
FX5-40SSC-G*2	Motion 4-axis control (CC-Link IE TSN compatible)	8 points	—	—	240 mA
FX5-80SSC-G*2	Motion 8-axis control (CC-Link IE TSN compatible)	8 points	—	—	240 mA
FX5-CCLGN-MS*3	CC-Link IE TSN master/local	8 points	—	—	220 mA
FX5-ENET*4	Ethernet communication	8 points	—	110 mA	—
FX5-ENET/IP*4	EtherNet/IP communication, Ethernet communication	8 points	—	110 mA	—
FX5-CCL-MS*1	CC-Link system master/intelligent device station	8 points*5	—	—	100 mA
FX5-CCLIEF*6	CC-Link IE Field Network intelligent device station	8 points	10 mA	—	230 mA
FX5-ASL-M*1	AnyWireASLINK system master	8 points	200 mA	—	100 mA*7
FX5-DP-M*4	PROFIBUS-DP master	8 points	—	150 mA	—
FX5-OPC*8	OPC UA communication	8 points	—	110 mA	—

\*1: Supported by FX5U CPU module Ver. 1.050 or later.

\*2: Supported by FX5U CPU module Ver. 1.230 or later.

\*3: Supported by FX5U CPU module Ver. 1.210 or later.

\*4: Supported by FX5U CPU module Ver. 1.110 or later.

\*5: When using FX5-CCL-MS as a master station, the number of remote I/O points on the network increases.

\*6: Supported by FX5U CPU module Ver. 1.030 or later.

\*7: This value does not include the supply current to remote modules (Max. 2 A).

\*8: Supported by FX5U CPU module Ver. 1.245 or later.

## 6 Connector conversion module

Model	Function	Number of occupied input/output points	Current consumption	
			5 V DC power supply	24 V DC power supply
FX5-CNV-IF	Connector conversion (FX5 (Extension cable type) →FX5 (Extension connector type))	—	—	—

## 7 I/O module (Extension connector type)

Model	I/O type	Number of occupied input/output points	Current consumption	
			5 V DC power supply	24 V DC power supply
FX5-C16EX/D	DC input (sink)	16 points	100 mA	65 mA (0 mA*)
FX5-C16EX/DS	DC input (sink/source)			
FX5-C32EX/D	DC input (sink)	32 points	120 mA	130 mA (0 mA*)
FX5-C32EX/DS	DC input (sink/source)			
FX5-C32EX/DS-TS	DC input (sink/source)			
FX5-C16EYT/D	Transistor output (sink)	16 points	100 mA	100 mA
FX5-C16EYT/DSS	Transistor output (source)			
FX5-C16EYR/D-TS	Relay output			
FX5-C32EYT/D	Transistor output (sink)	32 points	120 mA	200 mA
FX5-C32EYT/DSS	Transistor output (source)			
FX5-C32EYT/D-TS	Transistor output (sink)			
FX5-C32EYT/DSS-TS	Transistor output (source)			
FX5-C32ET/D	DC input (sink)/transistor output (sink)	32 points	120 mA	165 mA (100 mA*)
FX5-C32ET/DSS	DC input (sink/source)/transistor output (source)			
FX5-C32ET/DS-TS	DC input (sink/source)/transistor output (sink)			
FX5-C32ET/DSS-TS	DC input (sink/source)/transistor output (source)			

\*: Current consumption when an external power supply is used for the input circuits.

**8 Bus conversion module**

Model	Function	Number of occupied input/output points	Current consumption	
			5 V DC power supply	24 V DC power supply
FX5-CNV-BUSC	Bus conversion FX5 (extension cable type) → FX3 extension	8 points	150 mA	—
FX5-CNV-BUS	Bus conversion FX5 (extension cable type) → FX3 extension			

**9 FX5 expansion board**

Model	Function	Number of occupied input/output points	Current consumption	
			5 V DC power supply	24 V DC power supply
FX5-232-BD	RS-232C communication	—	20 mA	—
FX5-485-BD	RS-485 communication			
FX5-422-BD-GOT	RS-422 communication (for GOT connection)		20 mA*	

\*: The current consumption will increase when the 5 V type GOT is connected.

**10 FX5 expansion adapter**

Model	Function	Number of occupied input/output points	Current consumption			
			5 V DC power supply	24 V DC power supply	24 V DC external power supply	
FX5-232ADP	RS-232C communication	—	30 mA	30 mA	—	
FX5-485ADP	RS-485 communication		20 mA			
FX5-4A-ADP*1	2 ch voltage input/current input, 2 ch voltage output/current output		10 mA	—	20 mA	100 mA
FX5-4AD-ADP	4 ch voltage input/current input					—
FX5-4AD-PT-ADP*2	4 ch temperature sensor (resistance temperature detector) input					
FX5-4AD-TC-ADP*2	4 ch temperature sensor (thermocouple) input					
FX5-4DA-ADP	4 ch voltage output/current output					160 mA

\*1: Supported by FX5U CPU module Ver. 1.240 or later.

\*2: Supported by FX5U CPU module Ver. 1.040 or later.

**11 FX3 extension power supply module**

Model	Function	Number of occupied input/output points	Current consumption	
			5 V DC power supply	24 V DC power supply
FX3U-1PSU-5V	Extension power supply	—	1000 mA*	300 mA*

\*: Derating occurs when the ambient temperature exceeds 40°C. For details, refer to the manual.

**12 FX3 intelligent function module**

Model	Function	Number of occupied input/output points	Current consumption			
			5 V DC power supply	24 V DC power supply	24 V DC external power supply	
FX3U-4AD	4 ch voltage input/current input	8 points	110 mA	—	90 mA	
FX3U-4DA	4 ch voltage output/current output		120 mA		160 mA	
FX3U-4LC	4-loop temperature control (thermocouple/resistance temperature detector/micro voltage)		160 mA		50 mA	
FX3U-1PG	Pulse output for 1-axis control		150 mA		40 mA	
FX3U-2HC	2 ch high-speed counter		245 mA		—	
FX3U-16CCL-M	CC-Link master		8 points*1		—	240 mA
FX3U-64CCL	CC-Link intelligent device station		8 points		—	220 mA
FX3U-128ASL-M	AnyWireASLINK system master	8 points*2	130 mA	100 mA*3		
FX3U-32DP	PROFIBUS-DP slave station	8 points	—	145 mA	—	

\*1: When using FX3U-16CCL-M as a master station, the number of remote I/O points on the network increases.

\*2: The number of input/output points set by the rotary switch is added.

\*3: This value does not include the supply current to remote modules (Max. 2 A).

**13 FX5 safety extension module**

Model	Function	Number of occupied input/output points	Current consumption		
			5 V DC power supply	24 V DC power supply	24 V DC external power supply
FX5-SF-MU4T5*1*2	Safety main module 4-points safety input/4-points safety output	8 points	200 mA	5 mA	125 mA
FX5-SF-8DJ4*2	Safety input expansion module 8-points safety input	0 points	—	—	125 mA*3

\*1: Locate these modules on the rightmost side of the system configuration. However, this does not apply when the safety input extension module is connected. They cannot be used together with the bus conversion module or FX3 extension module.

\*2: Supported by FX5U CPU module Ver. 1.200 or later.

\*3: Supplied from external 24 V DC power supply of the FX5-SF-MU4T5.

## Calculation of current consumed by extension modules (For the AC power supply type)\*1

The power required for the expansion adapter, expansion board and extension module is supplied from the CPU module or extension power supply module. Use the following calculations to confirm whether the required power can be supplied. (All calculations must be satisfied.)

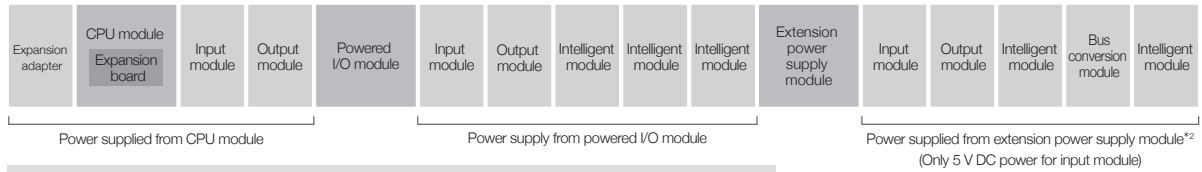

**■ Power supply from CPU module**

**[5 V DC power supply]**

5 V DC power supply capacity (CPU module)	-	Total current consumption (Total no. of extension devices to be connected)	=	Calculation results	≥	0 mA
---	---	--	---	---------------------	---	------

**[24 V DC power supply]**

24 V DC service power supply capacity (CPU module)	-	Total current consumption (Total no. of extension devices to be connected)	=	Calculation results	≥	0 mA*3
--	---	--	---	---------------------	---	--------

---

**■ Power supply from powered I/O module**

**[5 V DC power supply]**

5 V DC power supply capacity (Powered I/O module)	-	Total current consumption (Total no. of extension devices to be connected)	=	Calculation results	≥	0 mA
---	---	--	---	---------------------	---	------

**[24 V DC power supply]**

24 V DC service power supply capacity (Powered I/O module)	-	Total current consumption (Total no. of extension devices to be connected)	=	Calculation results	≥	0 mA*3
--	---	--	---	---------------------	---	--------

---

**■ Power supply from extension power supply module\*4**

**[5 V DC power supply]**

5 V DC power supply capacity (Extension power supply module)	-	Total current consumption (Total no. of extension devices to be connected)	=	Calculation results	≥	0 mA
--	---	--	---	---------------------	---	------

**[24 V DC power supply]**

24 V DC power supply capacity (Extension power supply module)	-	Total current consumption (Total no. of extension devices to be connected)	=	Calculation results	≥	0 mA
---	---	--	---	---------------------	---	------

**<Cautions>**

**If the calculation results are negative, the power capacity is exceeded so review the system configuration.**

Refer to the next section for the details of some products since the number of connected modules may be limited.

\*1: For calculation for the DC power supply type, refer to the manual.  
 \*2: When connecting an input module to the back stage (right side) of the extension power supply module, power will be supplied from the CPU module or a powered I/O module.  
 5 V DC power is supplied from an extension power supply module.  
 \*3: The 24 V DC service power calculation results value (when positive) indicates the 24 V DC service power supply's remaining capacity, and can be used as an external load power.  
 \*4: When using FX3 extension power supply module, another calculation is required. For details, refer to the manual.

Rules for System Configuration

The total number of I/O points and remote I/O points for the CPU module and extension devices controllable in FX5U CPU module is 512 points or less.

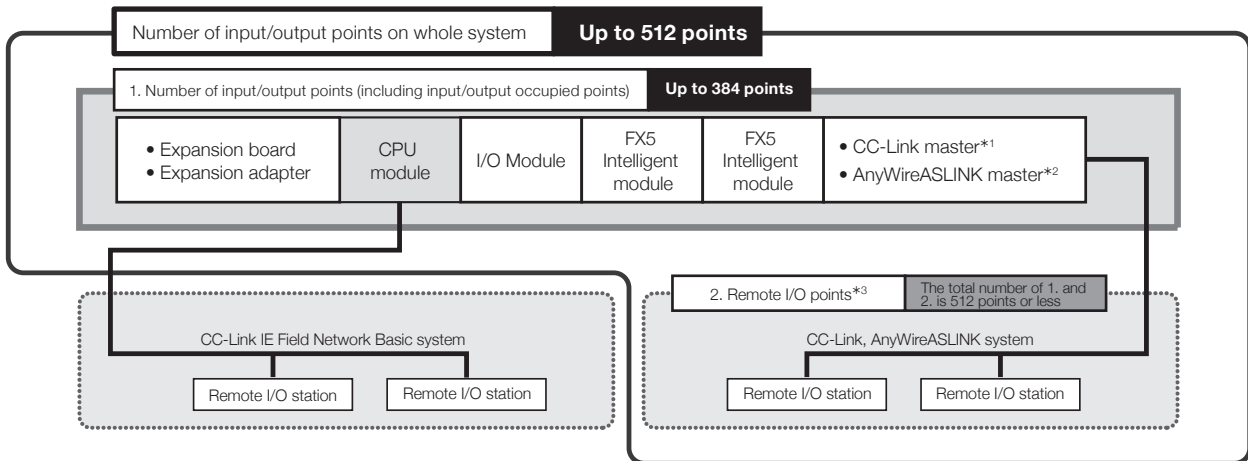

Number of input/output points

The maximum number of I/O points that can be configured with FX5U is as follows.

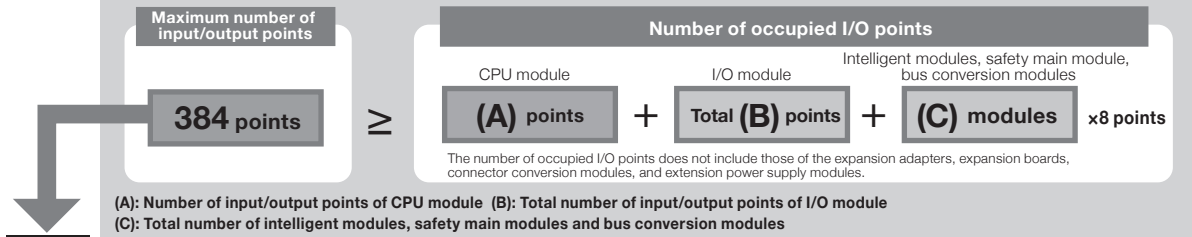

About remote I/O points

The maximum number of I/O points when using a network master module is as follows.

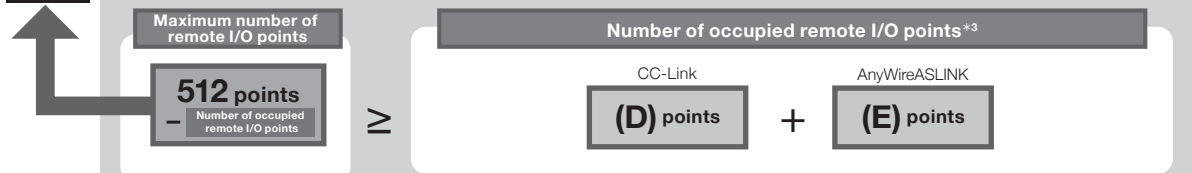

(D) Number of CC-Link remote I/O points

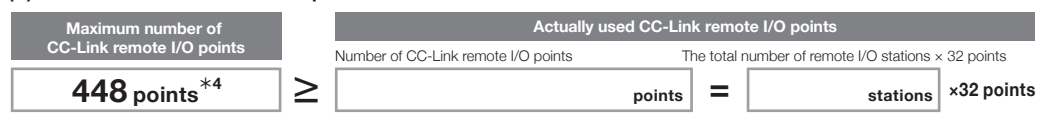

(E) Number of AnyWireASLINK remote I/O points

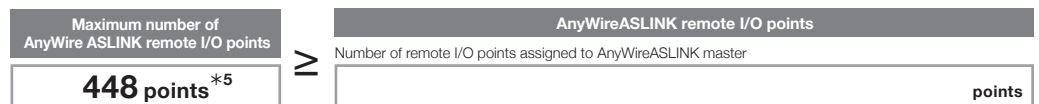

\*1: A bus conversion module is required when using the FX3U-16CCL-M.  
 \*2: A bus conversion module is required when using the FX3U-12BASL-M.  
 \*3: CC-Link IE Field Network Basic remote I/O stations are not calculated as remote I/O points.  
 \*4: 256 points when FX3U-16CCL-M is used.  
 \*5: 128 points when FX3U-12BASL-M is used.

The number of points will vary if the CPU module firmware version is below 1.110. For details, refer to the manual.



# Lineup Details/Model Selection

## Limitation on power supply type when connecting

It is not possible to install both the AC type and the DC type in one system.

The power supply type is limited for extension modules connectable to the following CPU modules. For details, refer to the manual.

Type/model/power supply type	Connectable extension module	
	Type	Model/power supply type
FX5U CPU module FX5U-□M□/E□ (AC power supply type)	Powered I/O module	FX5-32E□/E□ (AC power supply type)
	Extension power supply module	FX5-1PSU-5V (AC power supply type)
FX5U CPU module FX5U-□M□/D□ (DC power supply type)	Powered I/O module	FX5-32E□/D□ (DC power supply type)
	Extension power supply module	FX5-C1PS-5V (DC power supply type)

## Limitation on number of modules when extending

The number of connectable modules is limited for the following products. For details, refer to the manual.

Type	Model/type	Setting method/precautions
I/O module (Extension cable type)	FX5-16ET/ES-H FX5-16ET/ESS-H	Up to 4 modules can be connected for the entire system.
FX5 intelligent function module	FX5-CCLGN-MS	Only 1 module can be connected in the entire system for each station type. <ul style="list-style-type: none"> <li>Master station: 1 module</li> <li>Local station: 1 module</li> </ul> When 4 modules of the FX5-40SSC-G and FX5-80SSC-G are connected to the entire system, the FX5-CCLGN-MS (master station) cannot be connected.
	FX5-CCL-MS	Only 1 module can be connected in the entire system for each station type. <ul style="list-style-type: none"> <li>Master station: 1 module*<sup>1</sup></li> <li>Intelligent device station: 1 module*<sup>2</sup></li> </ul>
	FX5-ENET	Only 1 module can be connected in the entire system.
	FX5-ENET/IP	
	FX5-CCLIEF	
	FX5-DP-M	
	FX5-OPC	
FX5-ASL-M	Only 1 module can be connected in the entire system. Use together with the FX3U-128ASL-M is not possible.	
FX5-40SSC-G	Up to 4 modules can be connected for the entire system. Up to 4 modules of the FX5-40SSC-G, FX5-80SSC-G, and FX5-CCLGN-MS (master station) can be connected in total. By using a firmware version 1.001 or later, these models can be used with FX5-SF-MU4T5/FX5-SF-8DI4. If the following intelligent function modules are also used besides the safety extension modules (FX5-SF-MU4T5/FX5-SF-8DI4) and motion modules (FX5-40SSC-G/FX5-80SSC-G), use the following firmware version specified for each of them. <ul style="list-style-type: none"> <li>FX5-20PG-P: Ver. 1.011 or later</li> <li>FX5-20PG-D: Ver. 1.011 or later</li> <li>FX5-CCLGN-MS: Ver. 1.002 or later</li> <li>FX5-DP-M: Ver. 1.001 or later</li> </ul>	
FX5-80SSC-G	<ul style="list-style-type: none"> <li>FX5-20PG-P: Ver. 1.011 or later</li> <li>FX5-20PG-D: Ver. 1.011 or later</li> <li>FX5-CCLGN-MS: Ver. 1.002 or later</li> <li>FX5-DP-M: Ver. 1.001 or later</li> </ul>	
FX5 expansion adapter	FX5-232ADP	Up to 2 modules can be connected for the entire system.
	FX5-485ADP	
	FX5-4A-ADP* <sup>3</sup>	Up to 4 modules can be connected for the entire system. For FX5-4A-ADP with a serial number 223**** or older, up to two modules can be connected in the entire system.
	FX5-4AD-ADP	
	FX5-4DA-ADP	
	FX5-4AD-PT-ADP	
FX5-4AD-TC-ADP* <sup>4</sup>		
FX5 safety extension module	FX5-SF-MU4T5	Only 1 module of the FX5-SF-MU4T5 and up to 2 modules of the FX5-SF-8DI4 can be connected in the entire system. This module cannot be used together with the bus conversion module or FX3 extension module. If a motion module (FX5-40SSC-G, FX5-80SSC-G) is used with these modules, connect a motion module with firmware version 1.001 or later. If the following intelligent function modules are also used besides the FX5 safety extension modules and motion modules, use the following firmware version specified for each of them. <ul style="list-style-type: none"> <li>FX5-20PG-P: Ver. 1.011 or later</li> <li>FX5-20PG-D: Ver. 1.011 or later</li> <li>FX5-CCLGN-MS: Ver. 1.002 or later</li> <li>FX5-DP-M: Ver. 1.001 or later</li> </ul>
	FX5-SF-8DI4	
FX3 intelligent function module	FX3U-4AD	<ul style="list-style-type: none"> <li>When using FX3U-1PSU-5V: Up to 8 modules can be connected per system.</li> <li>When not using FX3U-1PSU-5V: Up to 6 modules can be connected per system.</li> </ul>
	FX3U-4DA	
	FX3U-1PG	
	FX3U-4LC	Only 1 module can be connected in the entire system. It cannot be used together with the FX5-ASL-M.
	FX3U-128ASL-M	
	FX3U-16CCL-M	Only 1 module can be connected in the entire system. When using the FX5-CCL-MS as the master station, it cannot be used together with the FX5-CCL-MS.
	FX3U-64CCL	Only 1 module can be connected in the entire system. When using the FX5-CCL-MS as the intelligent device station, it cannot be used together with the FX5-CCL-MS.
FX3U-2HC	Up to 2 modules can be connected for the entire system. When not using the FX3U-1PSU-5V, connect immediately after the bus conversion module.	

\*1: When using the FX5-CCL-MS as the master station, it cannot be used together with the FX3U-16CCL-M.

\*2: When using the FX5-CCL-MS as the intelligent device station, it cannot be used together with the FX3U-64CCL.

\*3: When two or more FX5-4DA-ADP are used, and if they are connected adjacent to FX5-4A-ADP with a serial number 223\*\*\*\* or older, connect them only to one side. Do not use both sides.

\*4: When the FX5-4DA-ADP and FX5-4A-ADP are used, and if they are connected adjacent to FX5-4AD-TC-ADP, connect them to either one side. Do not use both sides.

memo

# Selecting the FX5UC model

## ◇ Product configuration



**FX5UC**

- Control scale: 32 to 384 points (CPU module: 32/64/96 points)
- Control points up to 512 input/output points, including remote I/O\*

\*: For CC-Link and AnyWireASLINK

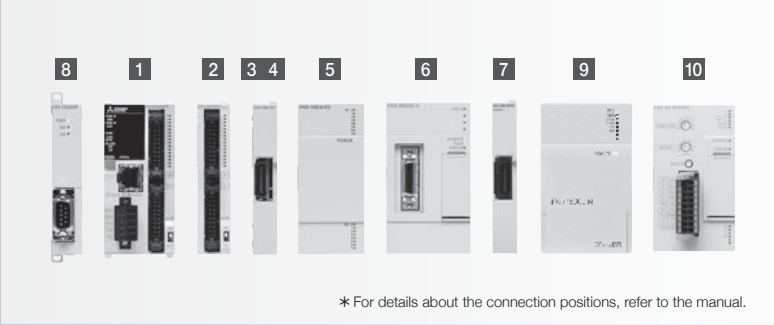

\* For details about the connection positions, refer to the manual.

Type	Details	Connection details, model selection
<b>1</b> CPU module	PLC with built-in CPU, power supply, input/output and program memory.	Various extension devices can be connected.
<b>2</b> I/O module (extension connector type)	Product for extension I/O of extension connector type.	The maximum number of input and output points for the entire system is 256 points/384 points*1. Up to 16 extension modules can be connected. (Extension power supply modules and connector conversion modules are not included in the number of connected modules.) For details, refer to "Rules for System Configuration" on p. 103.
<b>3</b> FX5 extension power supply module	Module for extension power supply if CPU module's internal power supply is insufficient. Connector conversion function is also provided.	Power can be supplied to I/O module, intelligent function module, and bus conversion module. Up to 2 modules can be connected.
<b>4</b> Connector conversion module	Module for connecting FX5 (extension cable type) extension module	Extension devices (extension cable type) for FX5 can be connected.
<b>5</b> I/O module (extension cable type)	Product for extending I/O of extension cable type.	The maximum number of input and output points for the entire system is 256 points/384 points*1. Up to 16 extension modules can be connected. (Connector conversion modules are not included in the number of connected modules.) Up to 4 high-speed pulse I/O modules can be connected. Using this type of I/O module requires the connector conversion module.
<b>6</b> FX5 intelligent function module	Module with functions other than input/output.	Up to 16 extension modules including I/O modules can be connected. (Connector conversion modules are not included in the number of connected modules.) Using this type of module requires the connector conversion module.
<b>7</b> Bus conversion module	Conversion module for connecting FX3 extension module.	FX3 Series extension modules can be connected only to the right side of the bus conversion module. Using the FX5-CNV-BUS requires the connector conversion module or extension power supply module.
<b>8</b> FX5 expansion adapter	Adapter connected to left side of CPU module to expand functions.	Up to 2 communication adapters and up to 4 analog adapters*2 (up to 6 adapters in total) can be connected on the left side of the CPU module.
<b>9</b> FX3 intelligent function module	Module with functions other than input/output.	Up to 6 modules*3 can be connected to the right side of the bus conversion module. The bus conversion module is required for use.
<b>10</b> FX5 safety extension module	Module for configuring a safety control system.	Up to 1 safety main module and up to 2 safety input extension modules can be connected. Extension modules cannot be connected on the downstream side (right side) of any safety extension module. Bus conversion modules and FX3 extension modules cannot be used simultaneously.

\*1: Supported by FX5UC Ver. 1.100 or later and by GX Works3 Ver. 1.047Z or later.  
 \*2: For FX5-4A-ADP with a serial number 223\*\*\*\* or older, up to two modules can be connected in the entire system.  
 \*3: Excluding some models

**1 CPU module**

Model	Function	Number of occupied input/output points	Power supply capacity		I/O type	No. of input points	No. of output points
			5 V DC power supply	24 V DC power supply			
FX5UC-32MT/D	CPU module	32 points	720 mA	500 mA	DC input (sink)/transistor (sink)	16 points	16 points
FX5UC-32MT/DSS					DC input (sink/source)/transistor (source)		
FX5UC-32MT/DS-TS					DC input (sink/source)/transistor (sink)		
FX5UC-32MT/DSS-TS					DC input (sink/source)/transistor (source)		
FX5UC-32MR/DS-TS					DC input (sink/source)/relay output		
FX5UC-64MT/D		64 points			32 points	32 points	
FX5UC-64MT/DSS		DC input (sink/source)/transistor (source)			32 points	32 points	
FX5UC-96MT/D		96 points			DC input (sink)/transistor (sink)	48 points	48 points
FX5UC-96MT/DSS					DC input (sink/source)/transistor (source)	48 points	48 points

**2 I/O module (extension connector type)**

Model	I/O type	Number of occupied input/output points	Current consumption		
			5 V DC power supply	24 V DC power supply	24 V DC external power supply (24 V DC power supply for input circuit)
FX5-C16EX/D	DC input (sink)	16 points	100 mA	-	65 mA
FX5-C16EX/DS	DC input (sink/source)				
FX5-C32EX/D	DC input (sink)	32 points	120 mA	-	130 mA
FX5-C32EX/DS	DC input (sink/source)				
FX5-C32EX/DS-TS					
FX5-C16EYT/D	Transistor output (sink)	16 points	100 mA	100 mA	-
FX5-C16EYT/DSS	Transistor output (source)				
FX5-C16EYR/D-TS	Relay output				
FX5-C32EYT/D	Transistor output (sink)	32 points	120 mA	200 mA	-
FX5-C32EYT/DSS	Transistor output (source)				
FX5-C32EYT/D-TS	Transistor output (sink)				
FX5-C32EYT/DSS-TS	Transistor output (source)				
FX5-C32ET/D	DC input (sink)/transistor output (sink)	32 points	120 mA	100 mA	65 mA
FX5-C32ET/DSS	DC input (sink/source)/transistor output (source)				
FX5-C32ET/DS-TS	DC input (sink/source)/transistor output (sink)				
FX5-C32ET/DSS-TS	DC input (sink/source)/transistor output (source)				

**3 FX5 extension power supply module**

Model	Function	Number of occupied input/output points	Power supply capacity	
			5 V DC power supply	24 V DC power supply
FX5-C1PS-5V	Extension power supply	-	1200 mA*	625 mA*

\*: Derating occurs when the ambient temperature exceeds 40°C. For details, refer to the manual.

**4 Connector conversion module**

Model	Function	Number of occupied input/output points	Current consumption	
			5 V DC internal current consumption	24 V DC internal current consumption
FX5-CNV-IFC	Connector conversion (FX5 (Extension connector type) → FX5 (Extension cable type))	-	-	-

**5 -1) I/O module (DC power supply/DC input type) (extension cable type)**

Model	Function	Number of occupied input/output points	Power supply capacity		I/O type
			5 V DC power supply	24 V DC power supply	
FX5-32ER/DS	Input/output module	32 points	965 mA	310 mA	DC input (sink/source)/relay output
FX5-32ET/DS					DC input (sink/source)/transistor output (sink)
FX5-32ET/DSS					DC input (sink/source)/transistor output (source)

# Lineup Details/Model Selection

## 5 -2) I/O module (extension cable type)

Model	Function	Number of occupied input/output points	Current consumption		
			5 V DC power supply	24 V DC power supply	24 V DC external power supply (24 V DC power supply for input circuit)
FX5-8EX/ES	DC input (sink/source)	8 points	75 mA	—	50 mA
FX5-16EX/ES	DC input (sink/source)	16 points	100 mA	—	85 mA
FX5-8EYR/ES	Relay output	8 points	75 mA	75 mA	—
FX5-8EYT/ES	Transistor output (sink)				
FX5-8EYT/ESS	Transistor output (source)				
FX5-16EYR/ES	Relay output	16 points	100 mA	125 mA	—
FX5-16EYT/ES	Transistor output (sink)				
FX5-16EYT/ESS	Transistor output (source)				
FX5-16ER/ES	DC input (sink/source)/relay output	16 points	100 mA	85 mA	40 mA
FX5-16ET/ES	DC input (sink/source)/transistor output (sink)				
FX5-16ET/ESS	DC input (sink/source)/transistor output (source)				
FX5-16ET/ES-H*	DC input (sink/source)/transistor output (sink)	16 points	100 mA	85 mA	40 mA
FX5-16ET/ESS-H*	DC input (sink/source)/transistor output (source)				

\*: Supported by FX5UC CPU module Ver. 1.030 or later.

## 6 FX5 intelligent function module

Model	Function	Number of occupied input/output points	Current consumption		
			5 V DC power supply	24 V DC power supply	24 V DC external power supply
FX5-4AD*1	4-ch voltage/current input	8 points	100 mA	40 mA	—
FX5-4DA*1	4-ch voltage/current output	8 points	100 mA	—	150 mA
FX5-8AD*1	8-ch voltage/current/thermocouple/resistance temperature detector input	8 points	—	40 mA	100 mA
FX5-4LC*1	4-ch temperature control (thermocouple/resistance temperature detector/micro voltage)	8 points	140 mA	—	25 mA
FX5-20PG-P*1	Pulse output for 2-axis control (transistor output)	8 points	—	—	120 mA
FX5-20PG-D*1	Pulse output for 2-axis control (differential driver output)	8 points	—	—	165 mA
FX5-40SSC-S	Simple motion 4-axis control (SSCNET III/H compatible)	8 points	—	—	250 mA
FX5-80SSC-S	Simple motion 8-axis control (SSCNET III/H compatible)	8 points	—	—	250 mA
FX5-40SSC-G*2	Motion 4-axis control (CC-Link IE TSN compatible)	8 points	—	—	240 mA
FX5-80SSC-G*2	Motion 8-axis control (CC-Link IE TSN compatible)	8 points	—	—	240 mA
FX5-CCLGN-MS*3	CC-Link IE TSN master/local	8 points	—	—	220 mA
FX5-ENET*4	Ethernet communication	8 points	—	110 mA	—
FX5-ENET/IP*4	EtherNet/IP communication, Ethernet communication	8 points	—	110 mA	—
FX5-CCL-MS*1	CC-Link system master/intelligent device station	8 points*5	—	—	100 mA
FX5-CCLIEF*6	CC-Link IE Field Network intelligent device station	8 points	10 mA	—	230 mA
FX5-ASL-M*1	AnyWireASLINK system master	8 points	200 mA	—	100 mA*7
FX5-DP-M*4	PROFIBUS-DP master	8 points	—	150 mA	—
FX5-OPC*8	OPC UA communication	8 points	—	110 mA	—

\*1: Supported by FX5UC CPU module Ver. 1.050 or later.

\*2: Supported by FX5UC CPU module Ver. 1.230 or later.

\*3: Supported by FX5UC CPU module Ver. 1.210 or later.

\*4: Supported by FX5UC CPU module Ver. 1.110 or later.

\*5: When using FX5-CCL-MS as a master station, the number of remote I/O points on the network increases.

\*6: Supported by FX5UC CPU module Ver. 1.030 or later.

\*7: This value does not include the supply current to remote modules (Max. 2 A).

\*8: Supported by FX5UC CPU module Ver. 1.245 or later.

## 7 Bus conversion module

Model	Function	Number of occupied input/output points	Current consumption	
			5 V DC power supply	24 V DC power supply
FX5-CNV-BUSC	Bus conversion FX5 (extension connector type) → FX3 extension	8 points	150 mA	—
FX5-CNV-BUS	Bus conversion FX5 (extension cable type) → FX3 extension			

**8 FX5 expansion adapter**

Model	Function	Number of occupied input/output points	Current consumption			
			5 V DC power supply	24 V DC power supply	24 V DC external power supply	
FX5-232ADP	RS-232C communication	—	30 mA	30 mA	—	
FX5-485ADP	RS-485 communication		20 mA			
FX5-4A-ADP*1	2 ch voltage input/current input, 2 ch voltage output/current output		10 mA	—	20 mA	100 mA
FX5-4AD-ADP	4 ch voltage input/current input					
FX5-4AD-PT-ADP*2	4 ch temperature sensor (resistance temperature detector) input		—	—	160 mA	
FX5-4AD-TC-ADP*2	4 ch temperature sensor (thermocouple) input					
FX5-4DA-ADP	4 ch voltage output/current output					

\*1: Supported by FX5UC CPU module Ver. 1.240 or later.  
 \*2: Supported by FX5UC CPU module Ver. 1.040 or later.

**9 FX3 intelligent function module**

Model	Function	Number of occupied input/output points	Current consumption		
			5 V DC power supply	24 V DC power supply	24 V DC external power supply
FX3U-4AD	4 ch voltage input/current input	8 points	110 mA	—	90 mA
FX3U-4DA	4 ch voltage output/current output		120 mA		160 mA
FX3U-4LC	4-loop temperature control (thermocouple/resistance temperature detector/micro voltage)		160 mA		50 mA
FX3U-1PG	Pulse output for 1-axis control		150 mA		40 mA
FX3U-2HC	2 ch high-speed counter		245 mA		—
FX3U-16CCL-M	CC-Link master	8 points*1	—	240 mA	
FX3U-64CCL	CC-Link intelligent device station	8 points	—	220 mA	
FX3U-128ASL-M	AnyWireASLINK system master	8 points*2	130 mA	100 mA*3	
FX3U-32DP	PROFIBUS-DP slave station	8 points	—	145 mA	—

\*1: When using FX3U-16CCL-M as a master station, the number of remote I/O points on the network increases.  
 \*2: The number of input/output points set by the rotary switch is added.  
 \*3: This value does not include the supply current to remote modules.

**10 FX5 safety extension module**

Model	Function	Number of occupied input/output points	Current consumption		
			5 V DC power supply	24 V DC power supply	24 V DC external power supply
FX5-SF-MU4T5*1*2	Safety main module 4-points safety input/4-points safety output	8 points	200 mA	5 mA	125 mA
FX5-SF-8DI4*2	Safety input expansion module 8-points safety input	0 points	—	—	125 mA*3

\*1: Locate these modules on the rightmost side of the system configuration. However, this does not apply when the safety input extension module is connected. They cannot be used together with the bus conversion module or FX3 extension module.  
 \*2: Supported by FX5UC CPU module Ver. 1.200 or later.  
 \*3: Supplied from external 24 V DC power supply of the FX5-SF-MU4T5.

## Calculation of current consumed by extension modules

The power required for the expansion adapter and extension module is supplied from the CPU module.  
Use the following calculations to confirm whether the required power can be supplied. (All calculations must be satisfied.)

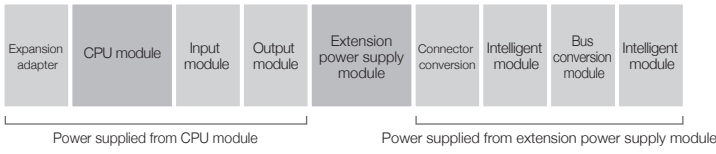

### ■ Power supply from CPU module [5 V DC power supply]

$$\text{5 V DC power supply capacity (CPU module)} - \text{Total current consumption (Total no. of extension devices to be connected)} = \text{Calculation results} \geq 0 \text{ mA}$$

### [24 V DC power supply]

$$\text{24 V DC power supply capacity (CPU module)} - \text{Total current consumption (Total no. of extension devices to be connected)} = \text{Calculation results} \geq 0 \text{ mA}$$

### ■ Power supply from extension power supply module [5 V DC power supply]

$$\text{5 V DC power supply capacity (Extension power supply module)} - \text{Total current consumption (Total no. of extension devices to be connected)} = \text{Calculation results} \geq 0 \text{ mA}$$

### [24 V DC power supply]

$$\text{24 V DC power supply capacity (Extension power supply module)} - \text{Total current consumption (Total no. of extension devices to be connected)} = \text{Calculation results} \geq 0 \text{ mA}$$

**<Cautions>**  
If the calculation results are negative, the power capacity is exceeded so review the system configuration.

Refer to the next section for the details of some products since the number of connected modules may be limited.



Rules for System Configuration

The total number of I/O points and remote I/O points for the CPU module and extension devices controllable in FX5UC CPU module is 512 points or less.

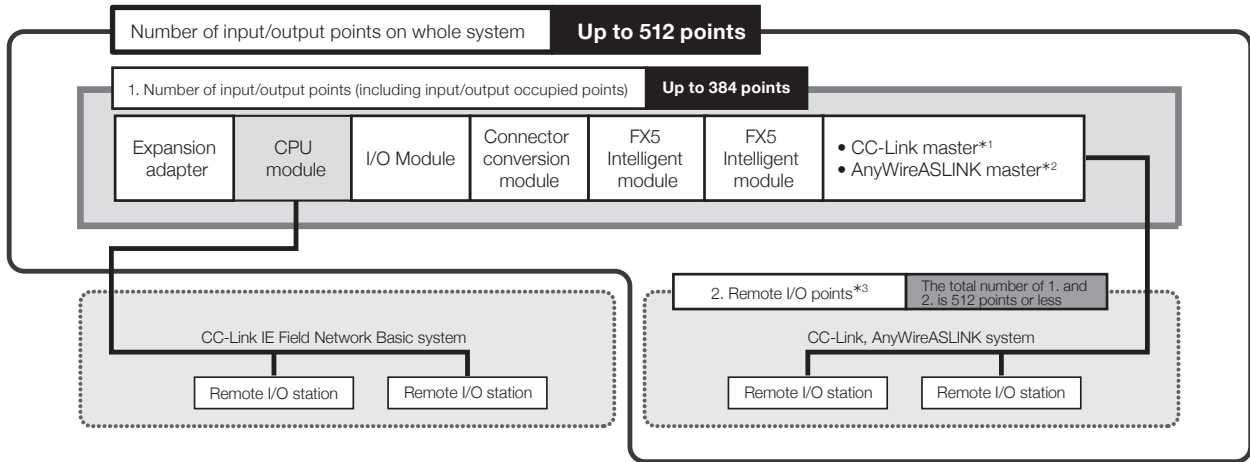

Number of input/output points

The maximum number of I/O points that can be configured with FX5UC is as follows.

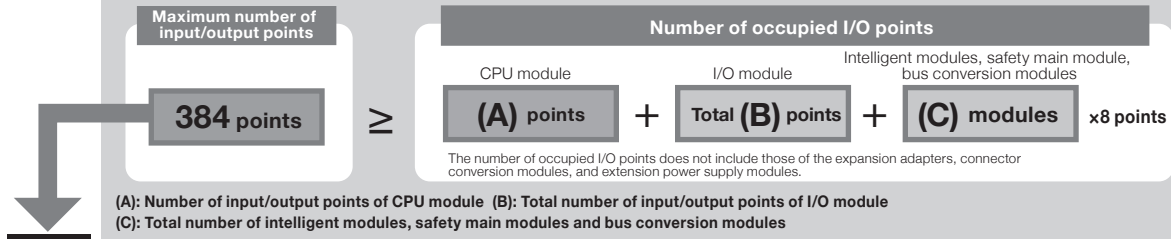

About remote I/O points

The maximum number of I/O points when using a network master module is as follows.

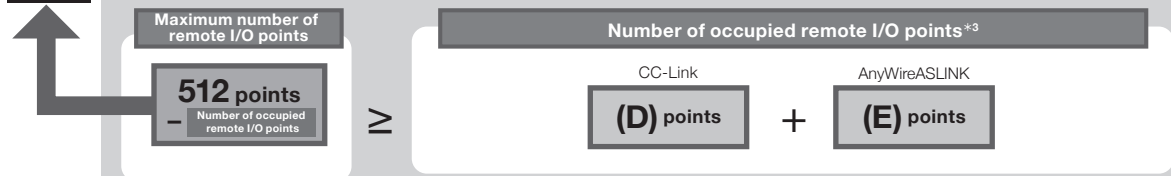

(D) Number of CC-Link remote I/O points

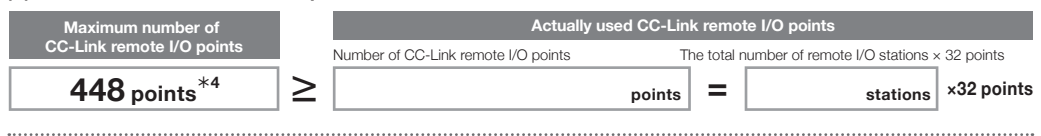

(E) Number of AnyWireASLINK remote I/O points

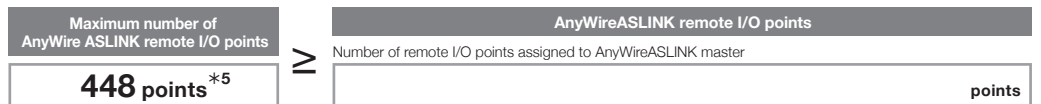

\*1: A bus conversion module is required when using the FX3U-16CCL-M.  
 \*2: A bus conversion module is required when using the FX3U-128ASL-M.  
 \*3: CC-Link IE Field Network Basic remote I/O stations are not calculated as remote I/O points.  
 \*4: 256 points when FX3U-16CCL-M is used.  
 \*5: 128 points when FX3U-128ASL-M is used.

The number of points will vary if the CPU module firmware version is below 1.110. For details, refer to the manual.

# Lineup Details/Model Selection

## Limitation on power supply type when connecting

The power supply type is limited for extension modules connectable to the following CPU modules. For details, refer to the manual.

Type/model/power supply type	Connectable extension module	
	Type	Model/power supply type
FX5UC CPU module FX5UC-□□□/□□ (DC power supply type)	Powered I/O module	FX5-32E□/□□ (DC power supply type)
	Extension power supply module	FX5-C1PS-5V (DC power supply type)

## Limitation on number of modules when extending

The number of connectable modules is limited for the following products. For details, refer to the manual.

Type	Model/type	Setting method/precautions
I/O module (Extension cable type)	FX5-16ET/ES-H	Up to 4 modules can be connected for the entire system.
	FX5-16ET/ESS-H	
FX5 intelligent function module	FX5-40SSC-G	Up to 4 modules can be connected for the entire system. Up to 4 modules of the FX5-40SSC-G, FX5-80SSC-G, and FX5-CCLGN-MS (master station) can be connected in total. By using a firmware version 1.001 or later, these models can be used with FX5-SF-MU4T5/FX5-SF-8DI4. If the following intelligent function modules are also used besides the safety extension modules (FX5-SF-MU4T5/FX5-SF-8DI4) and motion modules (FX5-40SSC-G/FX5-80SSC-G), use the following firmware version specified for each of them. <ul style="list-style-type: none"> <li>FX5-20PG-P: Ver. 1.011 or later</li> <li>FX5-20PG-D: Ver. 1.011 or later</li> <li>FX5-CCLGN-MS: Ver. 1.002 or later</li> <li>FX5-DP-M: Ver. 1.001 or later</li> </ul>
	FX5-80SSC-G	
	FX5-CCLGN-MS	Only 1 module can be connected in the entire system for each station type. <ul style="list-style-type: none"> <li>Master station: 1 module</li> <li>Local station: 1 module</li> </ul> When 4 modules of the FX5-40SSC-G and FX5-80SSC-G are connected to the entire system, the FX5-CCLGN-MS (master station) cannot be connected.
	FX5-CCL-MS	Only 1 module can be connected in the entire system for each station type. <ul style="list-style-type: none"> <li>Master station: 1 module*1</li> <li>Intelligent device station: 1 module*2</li> </ul>
	FX5-ENET	Only 1 module can be connected in the entire system.
	FX5-ENET/IP	
	FX5-CCLIEF	
	FX5-DP-M	
	FX5-OPC	
	FX5-ASL-M	Only 1 module can be connected in the entire system. Use together with the FX3U-128ASL-M is not possible.
FX5 expansion adapter	FX5-232ADP	Up to 2 modules can be connected for the entire system.
	FX5-485ADP	
	FX5-4A-ADP*3	
	FX5-4AD-ADP	Up to 4 modules can be connected for the entire system. For FX5-4A-ADP with a serial number 223**** or older, up to two modules can be connected in the entire system.
	FX5-4DA-ADP	
	FX5-4AD-PT-ADP	
FX5-4AD-TC-ADP*4		
FX5 safety extension module	FX5-SF-MU4T5	Only 1 module of the FX5-SF-MU4T5 and up to 2 modules of the FX5-SF-8DI4 can be connected in the entire system. This module cannot be used together with the bus conversion module or FX3 extension module. If a motion module (FX5-40SSC-G, FX5-80SSC-G) is used with these modules, connect a motion module with firmware version 1.001 or later. If the following intelligent function modules are also used besides the FX5 safety extension modules and motion modules, use the following firmware version specified for each of them. <ul style="list-style-type: none"> <li>FX5-20PG-P: Ver. 1.011 or later</li> <li>FX5-20PG-D: Ver. 1.011 or later</li> <li>FX5-CCLGN-MS: Ver. 1.002 or later</li> <li>FX5-DP-M: Ver. 1.001 or later</li> </ul>
	FX5-SF-8DI4	
FX3 intelligent function module	FX3U-4AD	Up to 6 modules can be connected for the entire system.
	FX3U-4DA	
	FX3U-1PG	
	FX3U-4LC	
	FX3U-128ASL-M	Only 1 module can be connected in the entire system. It cannot be used together with the FX5-ASL-M.
	FX3U-16CCL-M	Only 1 module can be connected in the entire system. When using the FX5-CCL-MS as the master station, it cannot be used together with the FX5-CCL-MS.
	FX3U-64CCL	Only 1 module can be connected in the entire system. When using the FX5-CCL-MS as the intelligent device station, it cannot be used together with the FX5-CCL-MS.
FX3U-2HC	Up to 2 modules can be connected for the entire system. Connect immediately after the bus conversion module.	

\*1: When using the FX5-CCL-MS as the master station, it cannot be used together with the FX3U-16CCL-M.

\*2: When using the FX5-CCL-MS as the intelligent device station, it cannot be used together with the FX3U-64CCL.

\*3: When two or more FX5-4DA-ADP are used, and if they are connected adjacent to FX5-4A-ADP with a serial number 223\*\*\*\* or older, connect them only to one side. Do not use both sides.

\*4: When the FX5-4DA-ADP and FX5-4A-ADP are used, and if they are connected adjacent to FX5-4AD-TC-ADP, connect them to either one side. Do not use both sides.

# Safety Extension Module

The safety extension module is designed to configure a safety control system with the FX5UJ/FX5U/FX5UC CPU module. A safety control system can be easily introduced by connecting the safety extension module, and general control and safety control can be performed only with this one system. The module has received the certification of the international safety standard (category 4, PL e, SIL3).

## Safety main module

The safety extension module is designed to configure a safety control system with the FX5UJ/FX5U/FX5UCCPU module. A safety control system can be configured only by connecting the safety main module to the FX5UJ/FX5U/FX5UC CPU module.

Model	Specifications		Compatible CPU module			
			FX5S	FX5UJ	FX5U	FX5UC
 <b>FX5-SF-MU4T5</b>	Total No. of points	8 points	×	○*1	○*1	○*1*2
	Number of safety inputs	4 points				
	Number of safety outputs	4 points				
	Maximum number of connectable modules	1 module				
	Safety integrity level (SIL)	SIL3 (IEC 61508)				
	Performance level (PL)	PL e (DIN EN ISO 13849-1)				
	Off delay time	0 / 0.5 / 1 / 1.5 / 2 / 2.5 / 3 / 3.5 / 4 / 5 s				
	Program for a safety control	9 types				

\*1: Supported by FX5UJ CPU modules Ver. 1.010 or later. Supported by FX5U/FX5UC CPU module Ver. 1.200 or later.  
 \*2: Connection with FX5UC CPU module requires connector conversion module (FX5-CNV-IFC) or extension power supply module (FX5-C1PS-5V).

## Safety input expansion module

The safety extension module is designed to configure a safety control system with the FX5UJ/FX5U/FX5UC CPU module. Safety input can be extended by connecting the safety input expansion module.

Model	Specifications		Compatible CPU module			
			FX5S	FX5UJ	FX5U	FX5UC
 <b>FX5-SF-8DI4</b>	Total No. of points	8 points	×	○*1	○*1	○*1*2
	Number of safety inputs	8 points				
	Number of safety outputs	—				
	Maximum number of connectable modules	2 modules				
	Safety integrity level (SIL)	SIL3 (IEC 61508)				
	Performance level (PL)	PL e (DIN EN ISO 13849-1)				
	Off delay time	—*3				
	Program for a safety control	9 types				

\*1: Supported by FX5UJ CPU modules Ver. 1.010 or later. Supported by FX5U/FX5UC CPU module Ver. 1.200 or later.  
 \*2: Connection with FX5UC CPU module requires connector conversion module (FX5-CNV-IFC) or extension power supply module (FX5-C1PS-5V).  
 \*3: The off-delay time is set on the safety main module.

## FX5-SF-MU4T5 safety main module

### ◆ Features



- 1) Module for configuring a safety control system.
- 2) It can be connected directly to the FX5UJ/FX5U/FX5UC CPU module. An existing general control system can be extended to a safety control system only by installing the safety main module.
- 3) A sequence program for safety control is unnecessary. A safety control system can be configured only by selecting a built-in program (9 kinds).
- 4) If any error occurs on the safety control side, the error status can be easily checked on the monitor or the diagnosis screen of GX Works3, and troubleshooting can be easily performed.

### ◆ Safety precautions

FX5-SF-MU4T5 is jointly developed and manufactured by Mitsubishi Electric Corporation and SICK AG. The warranty for this module differs from that of other PLC products. For warranty and specification, refer to the manual.

- \*1: For details regarding the general inputs, refer to the manual.
- \*2: The minimum switch-off time is the minimum time takes until a switch-off condition is detected after a module is switched off.
- \*3: A response time without any sensors. If a sensor is connected, the response time of the connected sensor is added to this value.
- \*4: The time from when a muting condition is enabled (I2/I3 are turned ON) until a muting function is activated.
- \*5: Indicates the maximum switch-off time when a muting error occurs.
- \*6: A muting input (I2 or I3) keeps OFF for the specified period of time.
- \*7: A time from when an ERROR LED starts flashing.
- \*8: A cross-circuit detection is performed only in the module.
- \*9: A response time without any sensors. If a sensor is connected, the response time of the connected sensor is added to this value.

### ◆ Specifications

Items		Specifications	
Safety integrity level		SIL3 (IEC 61508)/SILCL 3 (IEC 62061)	
Category		Category 4 (DIN EN ISO 13849-1)	
Performance level		PL e (DIN EN ISO 13849-1)	
PFHd		$1.5 \times 10^{-8}$	
Tm (mission time)		20 years (EN ISO 13849-1)	
Safety inputs*1	Number of inputs	4 points	
	Input voltage (ON)	13 V DC or more (13 V DC to 30 V DC)	
	Input voltage (OFF)	5 V DC or less (-5 V DC to 5 V DC)	
	Input current (ON)	3 mA (2.4 mA to 3.8 mA)	
	Input current (OFF)	2.1 mA or less (-2.5 mA to 2.1 mA)	
	Input response time (filter delay)	2 ms	
	Minimum switch-off time*2*3 (I0/I1)	Program 1, 2, 4, 5, 6, and 9	24 ms
		Program 3.1, 7, and 8	4 ms
		Program 3.2	76 ms/24 ms
	Minimum switch-off time*2*3 (I2/I3)	Program 4, 5, and 6	24 ms
		Program 1, 2, 3, 7, 8, and 9	4 ms
	Power-up time	70 ms	
	Synchronous time monitoring	Program 1 and 2	1500 ms
		Program 4 and 5	500 ms
	Muting ON*4	Program 3	61 ms
	Muting OFF	Program 3	61 ms (165 ms*5)
	Muting gap suppression*6	Program 3	94 ms to 100 ms
Reset time		106 ms	
Maximum teach-in time of the ENTER button*7		3 s	
Duration of actuation of a reset button (X0 and X1)		50 ms to 5 s	
Test outputs		For details, refer to the manual.	
Safety outputs	Number of outputs	4 points	
	Output method	Source output, short-circuit protection, cross-circuit detection*8	
	Output voltage	18.4 V DC to 30.0 V DC	
	Output current	2.0 A (@TA≤45°C) 1.5 A (@TA≤55°C)	
	Total current Isum	4.0 A (@TA≤45°C) 3.0 A (@TA≤55°C)	
	Leak current (in the switch OFF status)	1 mA or less	
	Response time*9 (I0/I1)	Program 1, 2, 4, 5, 6, and 9	29 ms
		Program 3.1, 7, and 8	9 ms
		Program 3.2	81 ms/29 ms
	Response time*9 (I2/I3)	Program 4, 5, and 6	29 ms
		Program 1, 2, 3, 7, 8, and 9	9 ms
Response time (XS0)		9 ms	
Off delay time		0 / 0.5 / 1 / 1.5 / 2 / 2.5 / 3 / 3.5 / 4 / 5 s	
Programs		0: Inactive 1: OR control (1) 2: OR control (2) 3: Muting control 4: Two-hand control (1) 5: Two-hand control (2) 6: AND control (1) 7: AND control (2) 8: Independent control 9: AND control (3)	
Power supply		5 V DC 200 mA, 24 V DC 5 mA (internal power supply) 24 V DC (+20%, -15%) 125 mA (external power supply)	
Compatible CPU module		FX5UJ: Ver. 1.010 or later FX5U, FX5UC: Ver. 1.200 or later Connection with FX5UC CPU module requires connector conversion module (FX5-CNV-IFC) or extension power supply module (FX5-C1PS-5V).	
Applicable engineering tool		FX5UJ: GX Works3 Ver. 1.075D or later FX5U, FX5UC: GX Works3 Ver. 1.060N or later	
Number of occupied I/O points		8 points (Either input or output is available for counting.)	
Number of connectable modules		FX5UJ: Up to 1 module FX5U: Up to 1 module FX5UC: Up to 1 module	
External dimensions W × H × D (mm)		50 × 90 × 102.2	
MASS (Weight): kg		Approx. 0.3	

## FX5-SF-8DI4 safety input expansion module

### ◆ Features



- 1) Safety input can be extended on the configured safety control system.
- 2) A sequence program for safety control is unnecessary. A safety control system can be configured only by selecting a built-in program (9 kinds).
- 3) If any error occurs on the safety control side, the error status can be easily checked on the monitor or the diagnosis screen of GX Works3, and troubleshooting can be easily performed.

### ◆ Safety precautions

FX5-SF-8DI4 is jointly developed and manufactured by Mitsubishi Electric Corporation and SICK AG.

The warranty for this module differs from that of other PLC products.

For warranty and specification, refer to the manual.

### ◆ Specifications

Items		Specifications
Safety integrity level		SIL3 (IEC 61508)/SILCL 3 (IEC 62061)
Category		Category 4 (DIN EN ISO 13849-1)
Performance level		PL e (DIN EN ISO 13849-1)
PFHd		$1.5 \times 10^{-8}$
Tm (mission time)		20 years (EN ISO 13849-1)
Safety inputs	Number of inputs	8 points
	Input voltage (ON)	13 V DC or more (13 V DC to 30 V DC)
	Input voltage (OFF)	5 V DC or less (-5 V DC to 5 V DC)
	Input current (ON)	3 mA (2.4 mA to 3.8 mA)
	Input current (OFF)	2.1 mA or less (-2.5 mA to 2.1 mA)
	Minimum switch-off time	Program 1, 2, 3, 4, 5, and 8 Program 6 and 7
	Synchronous time monitoring	Program 3 and 5
Power-up time		70 ms
Test outputs		For details, refer to the manual.
Response time	Program 1, 2, 3, 4, 5, and 8	33 ms
	Program 6 and 7	13 ms
Programs		0: Inactive 1: AND link (single channel) 2: AND link (dual channel) (1) 3: AND link (dual channel) (2) 4: AND link (dual channel) (3) 5: AND link (dual channel) (4) 6: AND link (dual channel) (5) 7: OR link (dual channel) 8: Bypass 9: All paths batch connection
Power supply		24 V DC (+20%, -15%) 125 mA (Internal power supply from the FX5-SF-MU4T5)
Compatible CPU module		FX5UJ: Ver. 1.010 or later FX5U, FX5UC: Ver. 1.200 or later Connection with FX5UC CPU module requires connector conversion module (FX5-CNV-IFC) or extension power supply module (FX5-C1PS-5V).
Applicable engineering tool		FX5UJ: GX Works3 Ver. 1.075D or later FX5U, FX5UC: GX Works3 Ver. 1.060N or later
Number of occupied I/O points		0 points (no occupied points)
Number of connectable modules		FX5UJ: Up to 2 modules FX5U: Up to 2 modules FX5UC: Up to 2 modules
External dimensions W × H × D (mm)		50 × 90 × 102.2
MASS (Weight): kg		Approx. 0.25

## Example of built-in program

### ◇ Safety main module built-in program

For the details of the programs and wiring of the safety main module and safety extension module, refer to the manuals, quick start guide for safety extension module (L(NA)08708ENG) or safety extension module configuration guide (see page 63).

Program number	Outline	Logic diagram	Program number	Outline	Logic diagram
1	OR control (1)		6	AND control (1)	
2	OR control (2)		7	AND control (2)	
3	Muting control		8	Independent control	
4	Two-hand control (1)		9	AND control (3)	
5	Two-hand control (2)				

\*: This is an off delay time. The factory default setting of the rotary switch is 0 second.

For the terms in the logic diagrams, refer to the following.

Left side of terminal arrangement		Right side of terminal arrangement	
Name	Description	Name	Description
I0	Safety input 0	Q0	Safety output 0
I1	Safety input 1	Q1	Safety output 1
I2	Safety input 2	Q2	Safety output 2
I3	Safety input 3	Q3	Safety output 3
AND	AND Operation	OR	OR Operation
N/C	An abbreviation for normally closed.	N/O	An abbreviation for normally open.



# I/O Module

The I/O module is a product for extending inputs/outputs.  
Some products are powered.

## Powered input/output modules

Powered input/output module is a powered input/output extension device.  
Like with the CPU module, various I/O modules and intelligent function modules can be connected to the rear stage of extension module.

### ◇ List of powered input/output modules

Model	Total No. of points	No. of input/output points, Input/output type		Compatible CPU module				MASS (Weight): kg	External dimensions W x H x D (mm)		
		Input	Output	FX5S	FX5UJ	FX5U	FX5UC				
<b>AC power supply type</b> 	32 points	16 points	24 V DC (sink/source)	16 points	Relay					Approx. 0.65	150 x 90 x 83
					Transistor (sink)	×	○	○*1	×		
					Transistor (source)						
<b>DC power supply type</b> 	32 points	16 points	24 V DC (sink/source)	16 points	Relay					Approx. 0.65	150 x 90 x 83
					Transistor (sink)	×	×	○*2	○*3		
					Transistor (source)						

\*1: Can be connected only to the AC power type system.

\*2: Can be connected only to the DC power type system.

\*3: Connection with FX5UC requires connector conversion module (FX5-CNV-IFC).

## Connection cable

The extension cable for connection to the right side of the front-stage device is offered as an accessory of each powered I/O module.

## I/O module

Input modules/output modules receive the power from the CPU module, and extend input/output points.  
Each module can be offered as the extension cable type or extension connector type.

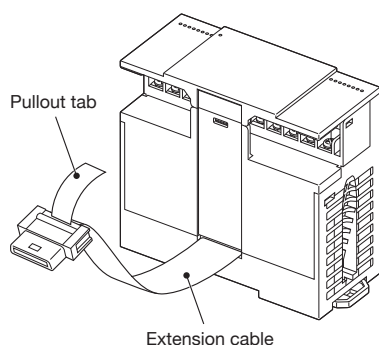

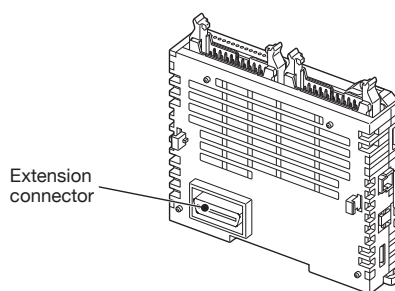

Extension cable type



Extension connector type







## ◇ List of input modules (extension cable type)

Model		Total No. of points	No. of input/output points, Input/output type				Compatible CPU module				MASS (Weight): kg	External dimensions W x H x D (mm)
			Input		Output		FX5S	FX5UJ	FX5U	FX5UC		
	FX5-8EX/ES	8 points	8 points	24 V DC (sink/source)	—	—	×	○	○	○*	Approx. 0.2	40 x 90 x 83
	FX5-16EX/ES	16 points	16 points	24 V DC (sink/source)	—	—					Approx. 0.25	

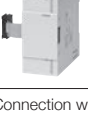

\*: Connection with FX5UC CPU module requires connector conversion module (FX5-CNV-IFC) or extension power supply module (FX5-C1PS-5V).

## ◇ List of output modules (extension cable type)

Model		Total No. of points	No. of input/output points, Input/output type				Compatible CPU module				MASS (Weight): kg	External dimensions W x H x D (mm)
			Input		Output		FX5S	FX5UJ	FX5U	FX5UC		
	FX5-8EYR/ES	8 points	—	—	8 points	Relay	×	○	○	○*	Approx. 0.2	40 x 90 x 83
	FX5-8EYT/ES	8 points			8 points	Transistor (sink)					Approx. 0.2	
	FX5-8EYT/ESS	8 points			8 points	Transistor (source)					Approx. 0.2	
	FX5-16EYR/ES	16 points			16 points	Relay					Approx. 0.25	
	FX5-16EYT/ES	16 points			16 points	Transistor (sink)					Approx. 0.25	
	FX5-16EYT/ESS	16 points			16 points	Transistor (source)					Approx. 0.25	

\*: Connection with FX5UC CPU module requires connector conversion module (FX5-CNV-IFC) or extension power supply module (FX5-C1PS-5V).

## ◇ List of input/output modules (extension cable type)

Model		Total No. of points	No. of input/output points, Input/output type				Compatible CPU module				MASS (Weight): kg	External dimensions W x H x D (mm)
			Input		Output		FX5S	FX5UJ	FX5U	FX5UC		
	FX5-16ER/ES	16 points	8 points	24 V DC (sink/source)	8 points	Relay	×	○	○	○*	Approx. 0.25	40 x 90 x 83
	FX5-16ET/ES					Transistor (sink)						
	FX5-16ET/ESS					Transistor (source)						

\*: Connection with FX5UC CPU module requires connector conversion module (FX5-CNV-IFC) or extension power supply module (FX5-C1PS-5V).

### ◇ List of high-speed pulse input/output modules (extension cable type)

Model		Total No. of points	No. of input/output points, Input/output type				Compatible CPU module				MASS (Weight): kg	External dimensions W × H × D (mm)
			Input		Output		FX5S	FX5UJ	FX5U	FX5UC		
	FX5-16ET/ES-H	16 points	8 points	24 V DC (sink/source)	8 points	Transistor (sink)	×	○	○	○*	Approx. 0.25	40 × 90 × 83
	FX5-16ET/ESS-H					Transistor (source)						

\*: Connection with FX5UC CPU module requires connector conversion module (FX5-CNV-IFC) or extension power supply module (FX5-C1PS-5V).

### Connection cable

Extension cable type input/output modules are equipped with the extension cable for connection to the right side of the front-stage device.

### ◇ List of input modules (extension connector type)

Model		Total No. of points	No. of input/output points, Input/output type				Compatible CPU module				MASS (Weight): kg	External dimensions W × H × D (mm)
			Input		Output		FX5S	FX5UJ	FX5U	FX5UC		
	FX5-C16EX/D	16 points	16 points	24 V DC (sink)	-	-	×	○*	○*	○	Approx. 0.1	14.6 × 90 × 87
	FX5-C16EX/DS			24 V DC (sink/source)							Approx. 0.1	14.6 × 90 × 87
	FX5-C32EX/D	32 points	32 points	24 V DC (sink)	-	-	×	○*	○*	○	Approx. 0.15	20.1 × 90 × 87
	FX5-C32EX/DS			24 V DC (sink/source)							Approx. 0.15	20.1 × 90 × 87
	FX5-C32EX/DS-TS			Approx. 0.15							20.1 × 90 × 93.7	

\*: Connection with FX5UJ/FX5U CPU module requires connector conversion module (FX5-CNV-IFC).

### ◇ List of output modules (extension connector type)

Model		Total No. of points	No. of input/output points, Input/output type				Compatible CPU module				MASS (Weight): kg	External dimensions W × H × D (mm)
			Input		Output		FX5S	FX5UJ	FX5U	FX5UC		
	FX5-C16EYT/D	16 points	-	-	16 points	Transistor (sink)	×	○*	○*	○	Approx. 0.1	14.6 × 90 × 87
	FX5-C16EYT/DSS					Transistor (source)					Approx. 0.1	14.6 × 90 × 87
	FX5-C16EYR/D-TS					Relay					Approx. 0.2	30.7 × 90 × 93.7
	FX5-C32EYT/D	32 points	-	-	32 points	Transistor (sink)	×	○*	○*	○	Approx. 0.15	20.1 × 90 × 87
	FX5-C32EYT/DSS					Transistor (source)					Approx. 0.15	20.1 × 90 × 87
	FX5-C32EYT/D-TS					Transistor (sink)					Approx. 0.15	20.1 × 90 × 93.7
	FX5-C32EYT/DSS-TS					Transistor (source)					Approx. 0.15	20.1 × 90 × 93.7

\*: Connection with FX5UJ/FX5U CPU module requires connector conversion module (FX5-CNV-IFC).

### ◇ List of I/O modules (extension connector type)

Model		Total No. of points	No. of input/output points, Input/output type				Compatible CPU module				MASS (Weight): kg	External dimensions W × H × D (mm)
			Input		Output		FX5S	FX5UJ	FX5U	FX5UC		
	FX5-C32ET/D	32 points	16 points	24 V DC (sink)	16 points	Transistor (sink)	×	○*	○*	○	Approx. 0.15	20.1 × 90 × 87
	FX5-C32ET/DSS			Transistor (source)		Approx. 0.15					20.1 × 90 × 87	
	FX5-C32ET/DS-TS			24 V DC (sink/source)		Transistor (sink)					Approx. 0.15	20.1 × 90 × 93.7
	FX5-C32ET/DSS-TS			Transistor (source)		Approx. 0.15					20.1 × 90 × 93.7	

\*: Connection with FX5UJ/FX5U CPU module requires connector conversion module (FX5-CNV-IFC).

Examples of combinations of FX5UJ inputs/outputs

The table below shows examples of combinations of FX5UJ extension modules. The contents of combinations can be described based on the number of input points.

- In addition to the combinations shown below, various combinations can be made by changing selected I/O modules and extension modules

Number of I/O points		CPU module		Input/output module		Powered input/output module FX5-32E		Input/output module		I/O total (Total occupied)	
Input	Output	Module model	Input	Output	Input	Output	Input	Output	Input	Output	
14	10	24M	14	10							24 (32)
14	18	24M	14	10	0	8					32 (40)
14	26	24M	14	10	0	16					40 (48)
14	34	24M	14	10	0	24					48 (56)
14	42	24M	14	10	0	32					56 (64)
14	50	24M	14	10	0	40					64 (72)
14	58	24M	14	10	0	48					72 (80)
14	74	24M	14	10	0	64					88 (96)
24	16	40M	24	16							40
24	24	40M	24	16	0	8					48
24	32	40M	24	16	0	16					56
24	40	40M	24	16	0	24					64
24	48	40M	24	16	0	32					72
24	56	40M	24	16	0	40					80
24	64	40M	24	16	0	48					88
24	80	40M	24	16	0	64					104
30	10	24M	14	10	16	0					40 (48)
30	26	24M	14	10	0	0	16	16			56 (64)
30	26	24M	14	10	16	16					56 (64)
30	34	24M	14	10	0	8	16	16			64 (72)
30	42	24M	14	10	0	16	16	16			72 (80)
30	50	24M	14	10	0	24	16	16			80 (88)
30	58	24M	14	10	0	32	16	16			88 (96)
30	66	24M	14	10	0	40	16	16			96 (104)
30	74	24M	14	10	0	48	16	16			104 (112)
30	90	24M	14	10	0	64	16	16			120 (128)
36	24	60M	36	24							60 (64)
36	32	60M	36	24	0	8					68 (72)
36	40	60M	36	24	0	16					76 (80)
36	48	60M	36	24	0	24					84 (88)
36	56	60M	36	24	0	32					92 (96)
36	64	60M	36	24	0	40					100 (104)
36	72	60M	36	24	0	48					108 (112)
36	88	60M	36	24	0	64					124 (128)

Number of I/O points		CPU module		Input/output module		Powered input/output module FX5-32E		Input/output module		I/O total (Total occupied)	
Input	Output	Module model	Input	Output	Input	Output	Input	Output	Input	Output	
40	16	40M	24	16	16	0					56
40	32	40M	24	16	0	0	16	16			72
40	32	40M	24	16	16	16					72
40	40	40M	24	16	0	8	16	16			80
40	48	40M	24	16	0	16	16	16			88
40	48	40M	24	16	16	32					88
40	56	40M	24	16	0	24	16	16			96
40	64	40M	24	16	0	32	16	16			104
40	72	40M	24	16	0	40	16	16			112
40	80	40M	24	16	0	48	16	16			120
40	96	40M	24	16	0	64	16	16			136
46	10	24M	14	10	32	0					56 (64)
46	26	24M	14	10	16	0	16	16			72 (80)
46	42	24M	14	10	0	0	16	16	16	16	88 (96)
46	42	24M	14	10	16	16	16	16			88 (96)
46	50	24M	14	10	0	8	16	16	16	16	96 (104)
46	58	24M	14	10	0	16	16	16	16	16	104 (112)
46	66	24M	14	10	0	24	16	16	16	16	112 (120)
46	74	24M	14	10	0	32	16	16	16	16	120 (128)
46	82	24M	14	10	0	40	16	16	16	16	128 (136)
46	90	24M	14	10	0	48	16	16	16	16	136 (144)
46	106	24M	14	10	0	64	16	16	16	16	152 (160)
52	24	60M	36	24	16	0					76 (80)
52	40	60M	36	24	0	0	16	16			92 (96)
52	40	60M	36	24	16	16					92 (96)
52	48	60M	36	24	0	8	16	16			100 (104)
52	56	60M	36	24	0	16	16	16			108 (112)
52	56	60M	36	24	16	32					108 (112)
52	64	60M	36	24	0	24	16	16			116 (120)
52	72	60M	36	24	0	32	16	16			124 (128)
52	80	60M	36	24	0	40	16	16			132 (136)
52	88	60M	36	24	0	48	16	16			140 (144)
52	104	60M	36	24	0	64	16	16			156 (160)

Number of I/O points		CPU module		Input/output module		Powered input/output module FX5-32E		Input/output module		I/O total (Total occupied)	
Input	Output	Module model	Input	Output	Input	Output	Input	Output	Input	Output	
56	16	40M	24	16	32	0					72
56	32	40M	24	16	16	0	16	16			88
56	32	40M	24	16	32	16					88
56	40	40M	24	16	32	24					96
56	48	40M	24	16	0	0	16	16	16	16	104
56	48	40M	24	16	16	16	16	16			104
56	56	40M	24	16	0	8	16	16	16	16	112
56	64	40M	24	16	0	16	16	16	16	16	120
56	64	40M	24	16	16	32	16	16			120
56	72	40M	24	16	0	24	16	16	16	16	128
56	80	40M	24	16	0	32	16	16	16	16	136
56	88	40M	24	16	0	40	16	16	16	16	144
56	96	40M	24	16	0	48	16	16	16	16	152
56	112	40M	24	16	0	64	16	16	16	16	168
68	24	60M	36	24	32	0					92 (96)
68	40	60M	36	24	16	0	16	16			108 (112)
68	40	60M	36	24	32	16					108 (112)
68	56	60M	36	24	0	0	16	16	16	16	124 (128)
68	56	60M	36	24	16	16	16	16			124 (128)
68	64	60M	36	24	0	8	16	16	16	16	132 (136)
68	72	60M	36	24	0	16	16	16	16	16	140 (144)
68	72	60M	36	24	16	32	16	16			140 (144)
68	80	60M	36	24	0	24	16	16	16	16	148 (152)
68	88	60M	36	24	0	32	16	16	16	16	156 (160)
68	96	60M	36	24	0	40	16	16	16	16	164 (168)
68	104	60M	36	24	0	48	16	16	16	16	172 (176)
68	120	60M	36	24	0	64	16	16	16	16	188 (192)
72	16	40M	24	16	48	0					88
72	32	40M	24	16	32	0	16	16			104
72	32	40M	24	16	48	16					104
72	48	40M	24	16	32	16	16	16			120
72	56	40M	24	16	32	24	16	16			128
72	64	40M	24	16	16	16	16	16	16	16	136
84	24	60M	36	24	48	0					108 (112)
84	40	60M	36	24	32	0	16	16			124 (128)
84	40	60M	36	24	48	16					124 (128)
84	56	60M	36	24	32	16	16				140 (144)

Number of I/O points		CPU module		Input/output module		Powered input/output module FX5-32E		Input/output module		I/O total (Total occupied)	
Input	Output	Module model	Input	Output	Input	Output	Input	Output	Input	Output	
88	16	40M	24	16	64	0					104
88	32	40M	24	16	48	0	16	16			120
88	40	40M	24	16	16	0	16	16	32	8	128
88	48	40M	24	16	48	16	16	16			136
88	56	40M	24	16	16	16	16	16	32	8	144
88	72	40M	24	16	16	32	16	16	32	8	160
100	24	60M	36	24	64	0					124 (128)
100	40	60M	36	24	48	0	16	16			140 (144)
100	48	60M	36	24	16	0	16	16	32	8	148 (152)
100	56	60M	36	24	48	16	16	16			156 (160)
100	64	60M	36	24	16	16	16	16	32	8	164 (168)
100	80	60M	36	24	16	32	16	16	32	8	180 (184)
104	32	40M	24	16	64	0	16	16			136
104	40	40M	24	16	32	0	16	16	32	8	144
104	56	40M	24	16	32	16	16	16	32	8	160
104	64	40M	24	16	32	24	16	16	32	8	168
116	40	60M	36	24	64	0	16	16			156 (160)
116	48	60M	36	24	32	0	16	16	32	8	164 (168)
116	64	60M	36	24	32	16	16	16	32	8	180 (184)
120	40	40M	24	16	48	0	16	16	32	8	160
120	56	40M	24	16	48	16	16	16	32	8	176
132	48	60M	36	24	48	0	16	16	32	8	180 (184)
132	64	60M	36	24	48	16	16	16	32	8	196 (200)
148	48	60M	36	24	64	0	16	16	32	8	196 (200)

Examples of combinations of FX5U inputs/outputs

The table below shows examples of combinations of FX5U extension modules. The contents of combinations can be described based on the number of input points.

- In addition to the combinations shown below, various combinations can be made by changing selected I/O modules and extension modules.

Number of I/O points		CPU module		Input/output module		Powered input/output module FX5-32E		Input/output module		I/O total	
Input	Output	Module model	Input	Output	Input	Output	Input	Output	Input		Output
16	16	32M	16	16							32
16	24	32M	16	16	0	8					40
16	32	32M	16	16	0	16					48
16	40	32M	16	16	0	24					56
16	48	32M	16	16	0	32					64
16	64	32M	16	16	0	48					80
24	16	32M	16	16	8	0					40
24	24	32M	16	16	8	8					48
24	32	32M	16	16	8	16					56
24	40	32M	16	16	8	24					64
32	16	32M	16	16	16	0					48
32	32	32M	16	16	16	16					64
32	32	32M	16	16	0	0	16	16			64
32	32	64M	32	32							64
32	40	32M	16	16	0	8	16	16			72
32	40	64M	32	32	0	8					72
32	48	32M	16	16	0	16	16	16			80
32	48	64M	32	32	0	16					80
32	56	32M	16	16	0	24	16	16			88
32	56	64M	32	32	0	24					88
32	64	64M	32	32	0	32					96
32	80	64M	32	32	0	48					112
32	80	64M	32	32	0	48					112
40	16	32M	16	16	24	0					56
40	24	32M	16	16	24	8					64
40	32	32M	16	16	8	0	16	16			72
40	40	32M	16	16	8	8	16	16			80
40	40	80M	40	40							80
40	56	80M	40	40	0	16					96
40	72	80M	40	40	0	32					112
40	88	80M	40	40	0	48					128
48	16	32M	16	16	32	0					64
48	32	32M	16	16	16	0	16	16			80
48	32	64M	32	32	16	0					80
48	48	32M	16	16	16	16	16	16			96
48	48	64M	32	32	16	16					96
48	48	64M	32	32	0	0	16	16			96
48	64	64M	32	32	16	32					112
48	64	64M	32	32	0	16	16	16			112
48	80	64M	32	32	0	32	16	16			128
48	96	64M	32	32	0	48	16	16			144

Number of I/O points		CPU module		Input/output module		Powered input/output module FX5-32E		Input/output module		I/O total	
Input	Output	Module model	Input	Output	Input	Output	Input	Output	Input		Output
56	32	32M	16	16	24	0	16	16			88
56	40	32M	16	16	24	8	16	16			96
56	40	80M	40	40	16	0					96
56	56	80M	40	40	16	16					112
56	56	80M	40	40	0	0	16	16			112
56	72	80M	40	40	16	32					128
56	72	80M	40	40	0	16	16	16			128
56	88	80M	40	40	0	32	16	16			144
56	104	80M	40	40	0	48	16	16			160
64	32	32M	16	16	32	0	16	16			96
64	32	64M	32	32	32	0					96
64	48	32M	16	16	0	0	16	16	32	16	112
64	48	64M	32	32	16	0	16	16			112
64	48	64M	32	32	32	16					112
64	56	32M	16	16	0	8	16	16	32	16	120
64	56	64M	32	32	32	24					120
64	64	32M	16	16	0	16	16	16	32	16	128
64	64	64M	32	32	16	16	16	16			128
64	72	32M	16	16	0	24	16	16	32	16	136
64	80	64M	32	32	16	32	16	16			144
72	40	80M	40	40	32	0					112
72	48	32M	16	16	8	0	16	16	32	16	120
72	56	32M	16	16	8	8	16	16	32	16	128
72	56	80M	40	40	32	16					128
72	56	80M	40	40	16	0	16	16			128
72	64	80M	40	40	32	24					136
72	72	80M	40	40	16	16	16	16			144
72	88	80M	40	40	16	32	16	16			160
80	32	64M	32	32	48	0					112
80	48	32M	16	16	16	0	16	16	32	16	128
80	48	64M	32	32	48	16					128
80	48	64M	32	32	32	0	16	16			128
80	64	32M	16	16	16	16	16	16	32	16	144
80	64	64M	32	32	32	16	16	16			144
80	72	64M	32	32	32	24	16	16			152
80	80	64M	32	32	0	16	16	16	32	16	160
80	96	64M	32	32	0	32	16	16	32	16	176
80	112	64M	32	32	0	48	16	16	32	16	192

Number of I/O points		CPU module		Input/output module		Powered input/output module FX5-32E		Input/output module		I/O total	
Input	Output	Module model	Input	Output	Input	Output	Input	Output	Input		Output
88	40	80M	40	40	48	0					128
88	48	32M	16	16	24	0	16	16	32	16	136
88	56	32M	16	16	24	8	16	16	32	16	144
88	56	80M	40	40	48	16					144
88	56	80M	40	40	32	0	16	16			144
88	64	32M	16	16	24	8	16	16	32	24	152
88	72	80M	40	40	32	16	16	16			160
88	80	80M	40	40	32	24	16	16			168
88	88	80M	40	40	0	16	16	16	32	16	176
88	104	80M	40	40	0	32	16	16	32	16	192
88	120	80M	40	40	0	48	16	16	32	16	208
96	32	64M	32	32	64	0					128
96	48	32M	16	16	32	0	16	16	32	16	144
96	48	64M	32	32	48	0	16	16			144
96	56	32M	16	16	32	0	16	16	32	24	152
96	64	64M	32	32	48	16	16	16			160
96	64	64M	32	32	16	0	16	16	32	16	160
96	80	64M	32	32	16	16	16	16	32	16	176
96	96	64M	32	32	16	32	16	16	32	16	192
104	40	80M	40	40	64	0					144
104	56	80M	40	40	48	0	16	16			160
104	72	80M	40	40	48	16	16	16			176
104	72	80M	40	40	16	0	16	16	32	16	176
104	88	80M	40	40	16	16	16	16	32	16	192
104	104	80M	40	40	16	32	16	16	32	16	208
112	48	64M	32	32	64	0	16	16			160
112	64	64M	32	32	32	0	16	16	32	16	176
112	80	64M	32	32	32	16	16	16	32	16	192
112	88	64M	32	32	32	24	16	16	32	16	200
120	56	80M	40	40	64	0	16	16			176
120	72	80M	40	40	32	0	16	16	32	16	192
120	88	80M	40	40	32	16	16	16	32	16	208
120	96	80M	40	40	32	24	16	16	32	16	216
128	64	64M	32	32	48	0	16	16	32	16	192
128	80	64M	32	32	48	16	16	16	32	16	208
128	88	64M	32	32	48	16	16	16	32	24	216
136	72	80M	40	40	48	0	16	16	32	16	208
136	88	80M	40	40	48	16	16	16	32	16	224
136	96	80M	40	40	48	16	16	16	32	24	232

Number of I/O points		CPU module		Input/output module		Powered input/output module FX5-32E		Input/output module		I/O total	
Input	Output	Module model	Input	Output	Input	Output	Input	Output	Input		Output
144	64	64M	32	32	64	0	16	16	32	16	208
144	72	64M	32	32	64	0	16	16	32	24	216
144	80	64M	32	32	64	0	16	16	32	32	224
152	72	80M	40	40	64	0	16	16	32	16	224
152	80	80M	40	40	64	0	16	16	32	24	232

Examples of combinations of FX5UC inputs/outputs

The table below shows examples of combinations of FX5UC extension modules. The contents of combinations can be described based on the number of input points.

- In addition to the combinations shown below, various combinations can be made by changing selected I/O modules and extension modules.

Number of I/O points		CPU module			Input/output module		Connector conversion module	Input/output module		I/O total
Input	Output	Module model	Input	Output	Input	Output		Input	Output	
16	16	32M	16	16	0	0				32
16	24	32M	16	16	0	0	●		8	40
16	32	32M	16	16	0	16				48
16	48	32M	16	16	0	32				64
24	16	32M	16	16	0	0	●	8		40
24	48	32M	16	16	0	32	●	8		72
24	64	32M	16	16	0	48	●	8		88
24	80	32M	16	16	0	64	●	8		104
32	16	32M	16	16	16	0				48
32	32	32M	16	16	16	16				64
32	32	64M	32	32	0	0				64
32	48	32M	16	16	16	32				80
32	48	64M	32	32	0	16				80
32	64	64M	32	32	0	32				96
32	72	32M	16	16	16	48	●		8	104
32	80	64M	32	32	0	48				112
40	16	32M	16	16	16	0	●	8		56
40	32	32M	16	16	16	16	●	8		72
40	32	64M	32	32	0	0	●	8		72
40	48	32M	16	16	16	32	●	8		88
40	64	64M	32	32	0	32	●	8		104
48	16	32M	16	16	32	0				64
48	32	64M	32	32	16	0				80
48	32	32M	16	16	32	16				80
48	48	32M	16	16	32	32				96
48	48	64M	32	32	16	16				96
48	48	96M	48	48	0	0				96
48	64	96M	48	48	0	16				112
48	64	64M	32	32	16	32				112
48	80	96M	48	48	0	32				128
56	32	32M	16	16	32	16	●	8		88
56	48	32M	16	16	32	32	●	8		104
56	48	64M	32	32	16	16	●	8		104
56	48	96M	48	48	0	0	●	8		104
56	64	32M	16	16	32	48	●	8		120
56	64	64M	32	32	16	32	●	8		120
56	64	96M	48	48	0	16	●	8		120
56	80	64M	32	32	16	48	●	8		136
56	96	96M	48	48	0	48	●	8		152
64	32	32M	16	16	48	16				96
64	48	64M	32	32	32	16				112
64	64	32M	16	16	48	48				128
64	64	96M	48	48	16	16				128
64	80	64M	32	32	32	48				144
64	96	96M	48	48	16	48				160

Number of I/O points		CPU module			Input/output module		Connector conversion module	Input/output module		I/O total
Input	Output	Module model	Input	Output	Input	Output		Input	Output	
72	32	32M	16	16	48	16	●	8		104
72	48	64M	32	32	32	16	●	8		120
72	64	32M	16	16	48	48	●	8		136
72	64	96M	48	48	16	16	●	8		136
72	64	64M	32	32	32	32	●	8		136
72	80	32M	16	16	48	64	●	8		152
72	80	64M	32	32	32	48	●	8		152
72	96	96M	48	48	16	48	●	8		168
80	32	64M	32	32	48	0				112
80	48	64M	32	32	48	16				128
80	48	32M	16	16	64	32				128
80	64	32M	16	16	64	48				144
80	64	96M	48	48	32	16				144
80	80	64M	32	32	48	48				160
80	80	32M	16	16	64	64				160
80	96	64M	32	32	48	64				176
80	96	96M	48	48	32	48				176
88	48	32M	16	16	64	32	●	8		136
88	48	64M	32	32	48	16	●	8		136
88	64	96M	48	48	32	16	●	8		152
88	64	32M	16	16	64	48	●	8		152
88	80	64M	32	32	48	48	●	8		168
88	80	96M	48	48	32	32	●	8		168
88	96	64M	32	32	48	64	●	8		184
88	112	64M	32	32	48	80	●	8		200
88	112	96M	48	48	32	64	●	8		200
88	128	96M	48	48	32	80	●	8		216
96	32	64M	32	32	64	0				128
96	48	96M	48	48	48	0				144
96	48	32M	16	16	80	32				144
96	64	32M	16	16	80	48				160
96	80	64M	32	32	64	48				176
96	96	32M	16	16	80	80				192
96	112	64M	32	32	64	80				208
96	112	96M	48	48	48	64				208
96	128	96M	48	48	48	80				224
96	144	96M	48	48	48	96				240
104	32	32M	16	16	80	16	●	8		136
104	48	96M	48	48	48	0	●	8		152
104	48	32M	16	16	80	32	●	8		152
104	48	64M	32	32	64	16	●	8		152
104	64	32M	16	16	80	48	●	8		168
104	64	64M	32	32	64	32	●	8		168
104	96	64M	32	32	64	64	●	8		200
104	112	96M	48	48	48	64	●	8		216
104	112	64M	32	32	64	80	●	8		216
104	128	96M	48	48	48	80	●	8		232



Number of I/O points		CPU module			Input/output module		Connector conversion module	Input/output module		I/O total
Input	Output	Module model	Input	Output	Input	Output		Input	Output	
112	64	64M	32	32	80	32				176
112	80	96M	48	48	64	32				192
112	96	32M	16	16	96	80				208
112	112	64M	32	32	80	80				224
112	112	96M	48	48	64	64				224
112	128	32M	16	16	96	112				240
112	128	64M	32	32	80	96				240
112	144	96M	48	48	64	96				256
120	64	32M	16	16	96	48	●	8		184
120	80	64M	32	32	80	48	●	8		200
120	96	96M	48	48	64	48	●	8		216
120	112	32M	16	16	96	96	●	8		232
120	112	64M	32	32	80	80	●	8		232
120	128	96M	48	48	64	80	●	8		248
120	128	64M	32	32	80	96	●	8		248
120	136	96M	48	48	64	80	●	8	8	256
128	64	32M	16	16	112	48				192
128	96	96M	48	48	80	48				224
128	96	32M	16	16	112	80				224
128	96	64M	32	32	96	64				224
128	112	96M	48	48	80	64				240
128	112	64M	32	32	96	80				240
128	128	96M	48	48	80	80				256
136	48	32M	16	16	112	32	●	8		184
136	80	64M	32	32	96	48	●	8		216
136	96	96M	48	48	80	48	●	8		232
136	96	64M	32	32	96	64	●	8		232
136	112	64M	32	32	96	80	●	8		248
136	120	96M	48	48	80	64	●	8	8	256
144	64	32M	16	16	128	48				208
144	80	64M	32	32	112	48				224
144	96	96M	48	48	96	48				240
144	112	64M	32	32	112	80				256
144	112	96M	48	48	96	64				256
152	64	32M	16	16	128	48	●	8		216
152	64	64M	32	32	112	32	●	8		216
152	96	96M	48	48	96	48	●	8		248
152	96	64M	32	32	112	64	●	8		248
152	104	96M	48	48	96	48	●	8	8	256
160	64	64M	32	32	128	32				224
160	80	96M	48	48	112	32				240
160	96	64M	32	32	128	64				256
160	96	96M	48	48	112	48				256
168	64	64M	32	32	128	32	●	8		232
168	80	96M	48	48	112	32	●	8		248
168	80	64M	32	32	128	48	●	8		248
168	88	96M	48	48	112	32	●	8	8	256

Number of I/O points		CPU module			Input/output module		Connector conversion module	Input/output module		I/O total
Input	Output	Module model	Input	Output	Input	Output		Input	Output	
176	64	64M	32	32	144	32				240
176	64	96M	48	48	128	16				240
176	80	64M	32	32	144	48				256
184	64	96M	48	48	128	16	●	8		248
184	64	64M	32	32	144	32	●	8		248
184	72	96M	48	48	128	16	●	8	8	256
192	48	64M	32	32	160	16				240
192	56	96M	48	48	144	0	●		8	248
192	64	96M	48	48	144	16				256
200	32	64M	32	32	160	0	●	8		232
200	48	96M	48	48	144	0	●	8		248
200	56	96M	48	48	144	0	●	8	8	256
208	48	96M	48	48	160	0				256

## I/O Module

memo

# Input/Output Devices for Voltage and Current

Analog input/output devices can be used to input and output analog amount of voltage, current, etc.

Analog control essential for FA control can easily be implemented by the PLC.

(For supporting micro voltage input of 0 to 10 mV DC, 0 to 100 mV DC, refer to FX5-4LC for "Input device for temperature sensor".)

## List of analog input/output devices

### ◇ Analog input/output expansion adapter

Model (Number of channels)	Input specifications			Isolation method	Compatible CPU module				Analog input points
	Item	Input current	Input voltage		FX5S	FX5UJ	FX5U	FX5UC	
<b>FX5-4A-ADP</b> (Input: 2 ch/ Output: 2 ch) 	Input range	-20 to +20 mA DC (Input resistance 250 Ω)	-10 to +10 V DC (Input resistance 1 MΩ)	Between input terminal and PLC: Photocoupler Between input channels: Non-isolation	○	○	○	○	2 points (2 ch)
	Resolution	1.25 μA (0 to 20 mA) 1.25 μA (4 to 20 mA) 2.5 μA (-20 to +20 mA)	625 μV (0 to 10 V) 312.5 μV (0 to 5 V) 312.5 μV (1 to 5 V) 1250 μV (-10 to +10 V)						
	Output specifications								
	Items	Output current	Output voltage	Between output terminal and PLC: Photocoupler Between output channels: Non-isolation					
	Output range	0 to 20 mA DC (External load resistance value 0 to 500 Ω)	-10 to +10 V DC (External load resistance value 1 kΩ to 1 MΩ)						
	Resolution	1.25 μA (0 to 20 mA) 1 μA (4 to 20 mA)	625 μV (0 to 10 V) 312.5 μV (0 to 5 V) 250 μV (1 to 5 V) 1250 μV (-10 to +10 V)						
									Analog output points
									2 points (2 ch)

### ◇ Analog input expansion adapter (A/D conversion)



Model (Number of channels)	Input specifications			Isolation method	Compatible CPU module				Analog input points
	Item	Input current	Input voltage		FX5S	FX5UJ	FX5U	FX5UC	
<b>FX5-4AD-ADP (4 ch)</b> 	Input range	-20 to +20 mA DC (Input resistance 250 Ω)	-10 to +10 V DC (Input resistance 1 MΩ)	Between input terminal and PLC: Photocoupler Between input channels: Non-isolation	○	○	○	○	4 points (4 ch)
	Resolution	1.25 μA (0 to 20 mA) 1.25 μA (4 to 20 mA) 2.5 μA (-20 to +20 mA)	625 μV (0 to 10 V) 312.5 μV (0 to 5 V) 312.5 μV (1 to 5 V) 1250 μV (-10 to +10 V)						

### ◇ Analog output expansion adapter (D/A conversion)

Model (Number of channels)	Output specifications			Isolation method	Compatible CPU module				Analog output points
	Items	Output current	Output voltage		FX5S	FX5UJ	FX5U	FX5UC	
<b>FX5-4DA-ADP (4 ch)</b> 	Output range	0 to 20 mA DC (External load resistance value 0 to 500 Ω)	-10 to +10 V DC (External load resistance value 1 kΩ to 1 MΩ)	Between output terminal and PLC: Photocoupler Between output channels: Non-isolation	○	○	○	○	4 points (4 ch)
	Resolution	1.25 μA (0 to 20 mA) 1 μA (4 to 20 mA)	625 μV (0 to 10 V) 312.5 μV (0 to 5 V) 250 μV (1 to 5 V) 1250 μV (-10 to +10 V)						

# Input/Output Devices for Voltage and Current

## ◇ Analog input module (A/D conversion)



Model (Number of channels)	Input specifications			Isolation method	Compatible CPU module				Analog input points
	Items	Input current	Input voltage		FX5S	FX5UJ	FX5U	FX5UC	
<b>FX5-4AD (4 ch)</b> 	Input range	-20 to +20 mA DC (Input resistance 250 Ω)	-10 to +10 V DC (Input resistance 400 kΩ or more)	Between input terminal and PLC: Photocoupler Between input terminal channels: Non-isolation	×	○	○	○*2	4 points (4 ch)
	Resolution	625 nA (0 to 20 mA) 500 nA (4 to 20 mA) 625 nA (-20 to +20 mA) 500 nA*1 (User range setting)	312.5 μV (0 to 10 V) 156.25 μV (0 to 5 V) 125 μV (1 to 5 V) 312.5 μV (-10 to +10 V) 125 μV*1 (User range setting)						
<b>FX5-8AD (8 ch)</b> 	Input range	-20 to +20 mA DC (Input resistance 250 Ω)	-10 to +10 V DC (Input resistance 1 MΩ)	Between input terminal and PLC: Photocoupler Between input terminal channels: Non-isolation	×	○	○	○*2	8 points (8 ch)
	Resolution	625 nA (0 to 20 mA) 500 nA (4 to 20 mA) 625 nA (-20 to +20 mA)	312.5 μV (0 to 10 V) 156.25 μV (0 to 5 V) 125 μV (1 to 5 V) 312.5 μV (-10 to +10 V)						
<b>FX3U-4AD (4 ch)</b> 	Input range	-20 to +20 mA DC, 4 to 20 mA DC (Input resistance 250 Ω)	-10 to +10 V DC (Input resistance 200 kΩ)	Between input terminal and PLC: Photocoupler Between input channels: Non-isolation	×	×	○*3	○*3	4 points (4 ch)
	Resolution	1.25 μA (-20 to +20 mA)	0.32 mV (-10 to +10 V)						

\*1: Maximum resolution in the user range setting.

\*2: Connection with FX5UC CPU module requires connector conversion module (FX5-CNV-IFC) or extension power supply module (FX5-C1PS-5V).

\*3: Connection with FX5U/FX5UC CPU module requires bus conversion module (FX5-CNV-BUS or FX5-CNV-BUSC).

## ◇ Analog output module (D/A conversion)

Model (Number of channels)	Output specifications			Isolation method	Compatible CPU module				Analog output points
	Items	Output current	Output voltage		FX5S	FX5UJ	FX5U	FX5UC	
<b>FX5-4DA (4 ch)</b> 	Output range	0 to 20 mA DC (External load resistance value 0 to 500 Ω)	-10 to +10 V DC (External load resistance value 1 kΩ to 1 MΩ)	Between output terminal and PLC: Photocoupler Between output channels: Non-isolation	×	○	○	○*2	4 points (4 ch)
	Resolution	625 nA (0 to 20 mA) 500 nA (4 to 20 mA) 500 nA*1 (User range setting)	312.5 μV (0 to 10 V) 156.25 μV (0 to 5 V) 125 μV (1 to 5 V) 312.5 μV (-10 to +10 V) 312.5 μV*1 (User range setting)						
<b>FX3U-4DA (4 ch)</b> 	Output range	0 to 20 mA DC, 4 to 20 mA DC (External load resistance value 500 Ω or less)	-10 to +10 V DC (external load resistance value 1 kΩ to 1 MΩ)	Between output terminal and PLC: Photocoupler Between output channels: Non-isolation	×	×	○*3	○*3	4 points (4 ch)
	Resolution	0.63 μA (0 to 20 mA)	0.32 mV (-10 to +10 V)						

\*1: Maximum resolution in the user range setting.

\*2: Connection with FX5UC CPU module requires connector conversion module (FX5-CNV-IFC) or extension power supply module (FX5-C1PS-5V).

\*3: Connection with FX5U/FX5UC CPU module requires bus conversion module (FX5-CNV-BUS or FX5-CNV-BUSC).

## ◇ FX5U CPU module

Built-in analog input

Model (Number of channels)	Input specifications		Isolation method
	Items	Input voltage	
<b>FX5U CPU module (2 ch)</b> 	Input range	0 to 10 V DC (Input resistance 115.7 kΩ)	Between analog input circuit and PLC circuit: Non-isolation Between input channels: Non-isolation
	Resolution	2.5 mV	

Built-in analog output

Model (Number of channels)	Output specifications		Isolation method
	Items	Output voltage	
<b>FX5U CPU module (1 ch)</b> 	Output range	0 to 10 V DC (External load resistance value 2 kΩ to 1 MΩ)	Between analog input circuit and PLC circuit: Non-isolation
	Resolution	2.5 mV	

### FX5-4A-ADP analog input/output expansion adapter

#### ◆ Features



- 1) Expansion adapter for adding 2-channel analog input and 2-channel analog output.
- 2) High-precision input/analog output adapter with resolution of 14 bits binary.
- 3) 2-channel analog input (voltage input: -10 to +10 V DC or current input: -20 to +20 mA DC) and 2-channel analog output (voltage output: -10 to +10 V DC or current output: 0 to 20 mA DC) are allowed.
- 4) Voltage or current input can be specified for each channel.
- 5) Data can be transferred programless (no dedicated instructions).

#### ◆ Specifications

Items	Specifications				
Analog input points	2 points (2 channels)				
Analog input voltage	-10 to +10 V DC (input resistance 1 MΩ)				
Analog input current	-20 to +20 mA DC (input resistance 250 Ω)				
Digital output value	14-bit binary value				
Analog input	Input characteristics, resolution*1	Analog input range	Digital output value	Resolution	
		Voltage	0 to 10 V	0 to 16000	625 μV
	0 to 5 V		0 to 16000	312.5 μV	
	1 to 5 V		0 to 12800	312.5 μV	
	-10 to +10 V		-8000 to +8000	1250 μV	
	Current	0 to 20 mA	0 to 16000	1.25 μA	
		4 to 20 mA	0 to 12800	1.25 μA	
		-20 to +20 mA	-8000 to +8000	2.5 μA	
		Accuracy (Accuracy in respect to full-scale digital output value)			Ambient temperature 25±5°C: within ±0.1% (±16 digits*2) Ambient temperature 0 to 55°C: within ±0.2% (±32 digits*2) Ambient temperature -20 to 0°C: within ±0.3% (±48 digits*2)
	Analog output	Analog output points	2 points (2 channels)		
Digital input		14-bit binary value			
Analog output voltage		-10 to +10 V DC (external load resistance value 1 kΩ to 1 MΩ)			
Analog output current		0 to 20 mA DC (external load resistance value 0 to 500 Ω)			
Output characteristics, resolution*1		Analog output range	Digital value	Resolution	
		Voltage	0 to 10 V	0 to 16000	625 μV
			0 to 5 V	0 to 16000	312.5 μV
			1 to 5 V	0 to 16000	250 μV
			-10 to +10 V	-8000 to +8000	1250 μV
		Current	0 to 20 mA	0 to 16000	1.25 μA
4 to 20 mA	0 to 16000		1 μA		
Accuracy (Accuracy in respect to full-scale analog output value)			Ambient temperature 25±5°C: ±0.1 % (Voltage ±20 mV, Current ±20 μA) Ambient temperature 0 to 55°C: ±0.2 % (Voltage ±40 mV, Current ±40 μA) Ambient temperature -20 to 0°C: ±0.3 % (Voltage ±60 mV, Current ±60 μA)		
Absolute maximum input	Voltage: ±15 V, Current: ±30 mA				
Conversion speed	FX5S CPU module: Maximum 2.2 ms (The data will be updated at every scan time of the PLC.) FX5UJ/FX5U/FX5UC CPU module: Maximum 2.0 ms (The data will be updated at every scan time of the PLC.)				
Isolation method	Between input terminal and PLC: Photocoupler Between input channels: Non-isolation				
Power supply	24 V DC +20%, -15% 100 mA (external power supply)*3 5 V DC, 10 mA (internal power supply)*3				
Compatible CPU module	FX5S: Compatible from initial product FX5UJ: Ver. 1.010 or later FX5U, FX5UC: Ver. 1.240 or later				
Number of occupied input/output points	0 points (no occupied points)				
Number of connectable modules	FX5S, FX5U, FX5UC CPU module: Up to 4 modules to the left side of CPU module*4, FX5UJ CPU module: Up to 2 modules to the left side of CPU module				
External dimensions W × H × D (mm)	17.6 × 106 × 89.1				
MASS (Weight): kg	Approx. 0.1				

\*1: For details on the input conversion and output conversion characteristics, refer to the manual.

\*2: Digit refers to digital values.

\*3: Current consumption calculation is not required for the FX5S/FX5UJ CPU module.

\*4: For FX5-4A-ADP with a serial number 223\*\*\*\* or older, up to two modules can be connected in the entire system.

## FX5-4AD-ADP analog input expansion adapter

### ◆ Features



- 1) High-precision analog input adapter with resolution of 14 bits binary.
- 2) 4-channel voltage input (-10 to +10 V DC) or current input (-20 to +20 mA DC) is allowed.
- 3) Voltage or current input can be specified for each channel.
- 4) Data can be transferred programless (no dedicated instructions).

### ◆ Specifications

Items	Specifications			
Analog input points	4 points (4 channels)			
Analog input voltage	-10 to +10 V DC (input resistance 1 MΩ)			
Analog input current	-20 to +20 mA DC (input resistance 250 Ω)			
Digital output value	14-bit binary value			
Input characteristics, resolution*1	Analog input range	Digital output value	Resolution	
	Voltage	0 to 10 V	0 to 16000	625 μV
		0 to 5 V	0 to 16000	312.5 μV
		1 to 5 V	0 to 12800	312.5 μV
	Current	-10 to +10 V	-8000 to +8000	1250 μV
0 to 20 mA		0 to 16000	1.25 μA	
4 to 20 mA		0 to 12800	1.25 μA	
	-20 to +20 mA	-8000 to +8000	2.5 μA	
Accuracy (Accuracy in respect to full-scale digital output value)	Ambient temperature 25±5°C: within ±0.1% (±16 digits*2) Ambient temperature 0 to 55°C: within ±0.2% (±32 digits*2) Ambient temperature -20 to 0°C*3: within ±0.3% (±48 digits*2)			
Absolute maximum input	Voltage: ±15 V, Current: ±30 mA			
Conversion speed	FX5S CPU module: Maximum 500 μs (The data will be updated at every scan time of the PLC.) FX5UJ/FX5U/FX5UC CPU module: Maximum 450 μs (The data will be updated at every scan time of the PLC.)			
Isolation method	Between input terminal and PLC: Photocoupler Between input channels: Non-isolation			
Power supply	24 V DC, 20 mA (internal power supply)*4 5 V DC, 10 mA (internal power supply)*4			
Compatible CPU module	FX5S, FX5UJ, FX5U, FX5UC: Compatible from initial product			
Number of occupied input/output points	0 points (no occupied points)			
Number of connectable modules	FX5S, FX5U, FX5UC: Up to 4 modules to the left side of CPU module, FX5UJ: Up to 2 modules to the left side of CPU module			
External dimensions W × H × D (mm)	17.6 × 106 × 89.1			
MASS (Weight): kg	Approx. 0.1			

\*1: For the input conversion characteristics, refer to manuals of each product.

\*2: Digit refers to digital values.

\*3: Products manufactured earlier than June 2016 do not support this specification.

\*4: Current consumption calculation is not required for the FX5S/FX5UJ CPU module.

## FX5-4DA-ADP analog output expansion adapter

### ◆ Features



- 1) High-precision analog output adapter with resolution of 14 bits binary.
- 2) 4-channel voltage output (-10 to +10 V DC) or current output (0 to 20 mA DC) is allowed.
- 3) Voltage or current output can be specified for each channel.
- 4) Data can be transferred programless (no dedicated instructions).

### ◆ Specifications

Items	Specifications			
Analog output points	4 points (4 channels)			
Digital input	14-bit binary value			
Analog output voltage	-10 to +10 V DC (external load resistance value 1 kΩ to 1 MΩ)			
Analog output current	0 to 20 mA DC (external load resistance value 0 to 500 Ω)			
Output characteristics, resolution*1	Analog output range	Digital value	Resolution	
	Voltage	0 to 10 V	0 to 16000	625 μV
		0 to 5 V	0 to 16000	312.5 μV
		1 to 5 V	0 to 16000	250 μV
	Current	-10 to +10 V	-8000 to +8000	1250 μV
0 to 20 mA		0 to 16000	1.25 μA	
4 to 20 mA		0 to 16000	1 μA	
Accuracy (Accuracy in respect to full-scale analog output value)	Ambient temperature 25±5°C: within ±0.1% (Voltage ±20 mV, Current ±20 μA) Ambient temperature -20 to 55°C*2: within ±0.2% (Voltage ±40 mV, Current ±40 μA)			
Conversion speed	FX5S CPU module: Maximum 1100 μs (The data will be updated at every scan time of the PLC.) FX5UJ/FX5U/FX5UC CPU module: Maximum 950 μs (The data will be updated at every scan time of the PLC.)			
Isolation method	Between output terminal and PLC: Photocoupler Between output channels: Non-isolation			
Power supply	24 V DC +20%, -15% 160 mA (external power supply) 5 V DC, 10 mA (internal power supply)*3			
Compatible CPU module	FX5S, FX5UJ, FX5U, FX5UC: Compatible from initial product			
Number of occupied input/output points	0 points (no occupied points)			
Number of connectable modules	FX5S, FX5U, FX5UC: Up to 4 modules to the left side of CPU module, FX5UJ: Up to 2 modules to the left side of CPU module			
External dimensions W × H × D (mm)	17.6 × 106 × 89.1			
MASS (Weight): kg	Approx. 0.1			

\*1: For details on the output conversion characteristic, refer to manuals of each product.

\*2: The ambient temperature specification is 0 to 55°C for products manufactured earlier than June 2016.

\*3: Current consumption calculation is not required for the FX5S/FX5UJ CPU module.

## FX5-4AD analog input module

### ◆ Features



- 1) High-precision analog input module with 312.5  $\mu\text{V}$  at voltage input and 625 nA at current input.
- 2) Spring clamp terminal block type with excellent vibration resistance.
- 3) Data of 10,000 points can be logged for each channel and saved in buffer memory. Leaving logs will be useful for analyzing the cause of trouble.

### ◆ Specifications

Items	Specifications			
Analog input points	4 points (4 channels)			
Analog input voltage	-10 to +10 V DC (Input resistance 400 k $\Omega$ or more)			
Analog input current	-20 to +20 mA DC (Input resistance 250 $\Omega$ )			
Absolute maximum input	Voltage: $\pm 15$ V, Current: $\pm 30$ mA			
Digital output value	16-bit signed binary (-32768 to +32767)			
Input characteristics, resolution*1	Analog input range	Digital output value	Resolution	
		Voltage		
	Voltage	0 to 10 V	0 to 32000	312.5 $\mu\text{V}$
		0 to 5 V	0 to 32000	156.25 $\mu\text{V}$
		1 to 5 V	0 to 32000	125 $\mu\text{V}$
		-10 to +10 V	-32000 to +32000	312.5 $\mu\text{V}$
		User range setting	-32000 to +32000	125 $\mu\text{V}$ *2
	Current	0 to 20 mA	0 to 32000	625 nA
		4 to 20 mA	0 to 32000	500 nA
-20 to +20 mA		-32000 to +32000	625 nA	
User range setting		-32000 to +32000	500 nA*2	
Accuracy (full scale digital output value accuracy)	Ambient temperature 25 $\pm$ 5 $^{\circ}\text{C}$ : within $\pm 0.1\%$ ( $\pm 64$ digits*3) Ambient temperature 0 to 55 $^{\circ}\text{C}$ : within $\pm 0.2\%$ ( $\pm 128$ digits*3) Ambient temperature -20 to 0 $^{\circ}\text{C}$ : within $\pm 0.3\%$ ( $\pm 192$ digits*3)			
Conversion speed	80 $\mu\text{s}/\text{ch}$			
Isolation method	Between input terminal and PLC: Photocoupler Between input terminal channels: Non-isolation			
Power supply	5 V DC, 100 mA (internal power supply) 24 V DC, 40 mA (internal power supply)			
Compatible CPU module	FX5UJ: Compatible from initial product FX5U, FX5UC: Ver. 1.050 or later Connection with FX5UC CPU module requires connector conversion module (FX5-CNV-IFC) or extension power supply module (FX5-C1PS-5V).			
Number of occupied I/O points	8 points (Either input or output is available for counting.)			
Number of connectable modules	FX5UJ: Up to 8 modules FX5U: Up to 16 modules FX5UC: Up to 15 modules			
External dimensions W x H x D (mm)	40 x 90 x 102.2			
MASS (Weight): kg	Approx. 0.2			

\*1: For the input conversion characteristics, refer to manuals of each product.

\*2: Maximum resolution in the user range setting.

\*3: Digit refers to digital values.

## FX5-8AD multiple input module

### ◆ Features



- 1) High precision multi input module with 312.5  $\mu\text{V}$  at voltage input and 625 nA at current input.
- 2) Spring clamp terminal block type with excellent vibration resistance.
- 3) Data of 10,000 points can be logged for each channel and saved in buffer memory. Leaving logs will be useful for analyzing the cause of trouble.

### ◆ Specifications

Items	Specifications			
Analog input points	8 points (8 channels)			
Analog input voltage	-10 to 10 V DC (input resistance 1 M $\Omega$ )			
Analog input current	-20 to +20 mA DC (input resistance 250 $\Omega$ )			
Absolute maximum input	Voltage: $\pm 15$ V, Current: $\pm 30$ mA			
Input characteristics, resolution*1	Analog input range	Digital output value	Resolution	
		Voltage		
	Voltage	0 to 10 V	0 to 32000	312.5 $\mu\text{V}$
		0 to 5 V	0 to 32000	156.25 $\mu\text{V}$
		1 to 5 V	0 to 32000	125 $\mu\text{V}$
		-10 to +10 V	-32000 to +32000	312.5 $\mu\text{V}$
		0 to 20 mA	0 to 32000	625 nA
	Current	4 to 20 mA	0 to 32000	500 nA
		-20 to +20 mA	-32000 to +32000	625 nA
Digital output value (16-bit signed binary value)				
16-bit signed binary (-32000 to +32000)				
Accuracy (accuracy for the full scale digital output value)	Ambient temperature 25 $\pm$ 5 $^{\circ}\text{C}$ : within $\pm 0.3\%$ ( $\pm 192$ digits*2) Ambient temperature -20 to +55 $^{\circ}\text{C}$ : within $\pm 0.5\%$ ( $\pm 320$ digits*2)			
Conversion speed	1 ms/ch			
Isolation method	Between input terminal and PLC: Photocoupler Between input terminal channels: Non-isolation			
Power supply	24 V DC, 40 mA (internal power supply) 24 V DC +20%, -15% 100 mA (external power supply)			
Compatible CPU module	FX5UJ: Compatible from initial product FX5U, FX5UC: Ver. 1.050 or later Connection with FX5UC CPU module requires connector conversion module (FX5-CNV-IFC) or extension power supply module (FX5-C1PS-5V).			
Number of occupied I/O points	8 points (Either input or output is available for counting.)			
Number of connectable modules	FX5UJ: Up to 8 modules FX5U: Up to 16 modules FX5UC: Up to 15 modules			
External dimensions W x H x D (mm)	50 x 90 x 102.2			
MASS (Weight): kg	Approx. 0.3			

\*1: For the input conversion characteristics, refer to manuals of each product.

\*2: Digit refers to digital values.



## FX3U-4AD special function block for analog input

### ◆ Features



- 1) High-precision analog input module with resolution of 15 bits binary + 1-bit sign (voltage) and 14 bits binary + 1-bit sign (current).
- 2) 4-channel voltage input (-10 to +10 V DC) or current input (-20 to +20 mA DC, 4 to 20 mA DC) is allowed.
- 3) Voltage or current input can be specified for each channel.
- 4) High-speed AD conversion of 500  $\mu$ s/ch has been implemented.
- 5) Various functions such as digital filter function and peak value hold function have been provided.

### ◆ Specifications

Items	Input voltage	Input current
Analog input range	-10 to +10 V DC (Input resistance 200 k $\Omega$ )	-20 to +20 mA DC, 4 to 20 mA (Input resistance 250 $\Omega$ )
Effective digital output	15 bits binary + 1-bit sign	14 bits binary + 1-bit sign
Resolution	0.32 mV (20 V $\times$ 1/64000)	1.25 $\mu$ A (40 mA $\times$ 1/32000)
Total precision	[With ambient temperature 25°C $\pm$ 5°C] $\pm$ 0.3% in respect to full-scale 20 V ( $\pm$ 60 mV) [With ambient temperature 0 to 55°C] $\pm$ 0.5% in respect to full-scale 20 V ( $\pm$ 100 mV)	[With ambient temperature 25°C $\pm$ 5°C] With input of -20 to +20 mA $\pm$ 0.5% ( $\pm$ 200 $\mu$ A) in respect to full-scale 40 mA Same as with input 4 to 20 mA [With ambient temperature 0 to 55°C] With input of -20 to +20 mA $\pm$ 1% ( $\pm$ 400 $\mu$ A) in respect to full-scale 40 mA Same as with input 4 to 20 mA
Conversion speed	500 $\mu$ s $\times$ Number of channels (5 ms $\times$ Number of channels used when digital filter is used)	
Isolation method	Between input terminal and PLC: Photocoupler Between input terminal channels: Non-isolation	
Power supply	5 V DC, 110 mA (internal power supply) 24 V DC $\pm$ 10% 90 mA/24 V DC (external power feed)	
Compatible CPU module	FX5U, FX5UC: Compatible from initial product Connection with FX5U/FX5UC CPU module requires bus conversion module (FX5-CNV-BUS or FX5-CNV-BUSC).	
Number of occupied input/output points	8 points (Either input or output is available for counting.)	
Communication with PLC	Carried out by FROM/TO instruction via buffer memory (buffer memory can directly be specified)	
Number of connectable modules	FX5U: Up to 8 modules when FX3U extension power supply modules are used Up to 6 modules when FX3U extension power supply modules are not used FX5UC: Up to 6 modules	
External dimensions W $\times$ H $\times$ D (mm)	55 $\times$ 90 $\times$ 87	
MASS (Weight): kg	Approx. 0.2	

## FX5-4DA special function block for analog output

### ◆ Features

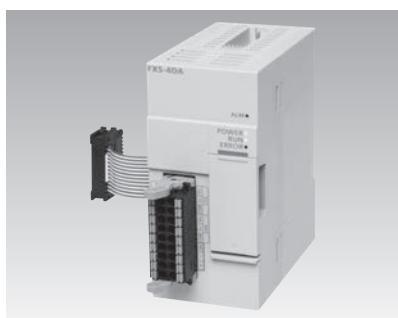

- 1) High-precision analog output module with 312.5  $\mu$ V at voltage output and 625 nA at current output.
- 2) Spring clamp terminal block type with excellent vibration resistance.
- 3) Built-in waveform output function for continuous analog output at a set conversion cycle by registering prepared waveform data (digital value) to the module extension parameter. Faster and smoother output than with programming, and program-free control for reduced overall programming work.

### ◆ Specifications

Items	Specifications			
Analog output points	4 points (4 channels)			
Analog output voltage	-10 to +10 V DC (external load resistance 1 k $\Omega$ to 1 M $\Omega$ )			
Analog output current	0 to 20 mA DC (external load resistance 0 to 500 $\Omega$ )			
Digital input	16-bit signed binary (-32768 to +32767)			
Output characteristics, resolution*1	Voltage	Analog output range		Resolution
		0 to 10 V	0 to 32000	312.5 $\mu$ V
		0 to 5 V	0 to 32000	156.3 $\mu$ V
		1 to 5 V	0 to 32000	125 $\mu$ V
		-10 to +10 V	-32000 to +32000	312.5 $\mu$ V
	User range setting	-32000 to +32000	312.5 $\mu$ V*2	
	Current	0 to 20 mA	0 to 32000	625 nA
4 to 20 mA		0 to 32000	500 nA	
User range setting		-32000 to +32000	500 nA*2	
Accuracy (full scale analog output value accuracy)	Ambient temperature 25 $\pm$ 5°C: within $\pm$ 0.1% (Voltage $\pm$ 20 mV, Current $\pm$ 20 $\mu$ A) Ambient temperature 0 to 55°C: within $\pm$ 0.2% (Voltage $\pm$ 40 mV, Current $\pm$ 40 $\mu$ A) Ambient temperature -20 to 0°C: within $\pm$ 0.3% (Voltage $\pm$ 60 mV, Current $\pm$ 60 $\mu$ A)			
Conversion speed	80 $\mu$ s/ch			
Isolation method	Between output terminal and PLC: Photocoupler Between output channels: Non-isolation			
Power supply	5 V DC, 100 mA (internal power supply) 24 V DC +20%, -15% 150 mA (external power supply)			
Compatible CPU module	FX5UJ: Compatible from initial product FX5U, FX5UC: Ver. 1.050 or later Connection with FX5UC CPU module requires connector conversion module (FX5-CNV-IFC) or extension power supply module (FX5-C1PS-5).			
Number of occupied I/O points	8 points (Either input or output is available for counting.)			
Number of connectable modules	FX5UJ: Up to 8 modules FX5U: Up to 16 modules FX5UC: Up to 15 modules			
External dimensions W $\times$ H $\times$ D (mm)	40 $\times$ 90 $\times$ 102.2			
MASS (Weight): kg	Approx. 0.2			

\*1: For details on the output conversion characteristic, refer to manuals of each product.  
\*2: Maximum resolution in the user range setting.

### FX3U-4DA special function block for analog output

#### ◆ Features



- 1) High-precision analog output module with resolution of 15 bits binary + 1-bit sign (voltage) and 15 bits binary (current).
- 2) 4-channel voltage output (-10 to +10 V DC) or current output (0 to 20 mA DC, 4 to 20 mA DC) is allowed.
- 3) Voltage or current output can be specified for each channel.
- 4) Various functions such as table output function and upper-limit/lower-limit value function have been provided.

#### ◆ Specifications

Items	Output voltage	Output current
Analog output range	-10 to +10 V DC (External load 1 kΩ to 1 MΩ)	0 to 20 mA DC, 4 to 20 mA DC (External load 500 Ω or less)
Effective digital input	15 bits binary + 1-bit sign	15-bit binary value
Resolution	0.32 mV (20 V × 1/64000)	0.63 μA (20 mA × 1/32000)
Total precision	Ambient temperature 25±5°C ±0.3% (±60 mV) in respect to full-scale 20 V Ambient temperature 0 to 55°C ±0.5% (±100 mV) in respect to full-scale 20 V	Ambient temperature 25±5°C ±0.3% (±60 μA) in respect to full-scale 20 mA Ambient temperature 0 to 55°C ±0.5% (±100 μA) in respect to full-scale 20 mA
Conversion speed	1 ms (unrelated to the number of channels used)	
Isolation method	Between output terminal and PLC: Photocoupler Between output terminal channels: Non-isolation	
Power supply	5 V DC, 120 mA (internal power supply) 24 V DC ±10% 160 mA/24 V DC (external power feed)	
Compatible CPU module	FX5U, FX5UC: Compatible from initial product Connection with FX5U/FX5UC CPU module requires bus conversion module (FX5-CNV-BUS or FX5-CNV-BUSC).	
Number of occupied input/output points	8 points (Either input or output is available for counting.)	
Communication with PLC	Carried out by FROM/TO instruction via buffer memory (buffer memory can directly be specified)	
Number of connectable modules	FX5U: Up to 8 modules when FX3U extension power supply modules are used Up to 6 modules when FX3U extension power supply modules are not used FX5UC: Up to 6 modules	
External dimensions W × H × D (mm)	55 × 90 × 87	
MASS (Weight): kg	Approx. 0.2	

### Built-in analog input/output function of FX5U CPU module

#### ◆ Features



FX5U CPU module has built-in analog input/output. It contains 2-channel analog input and 1-channel analog output.

#### ◆ Specifications (built-in analog input/output only)

Items		Specifications
A/D part	Analog input	0 to 10 V DC (Input resistance 115.7 Ω)
	Absolute maximum input	-0.5 V, +15 V
	Digital output value	0 to 4000
	Digital output	Unsigned 12-bit binary
	Maximum resolution	2.5 mV
	Precision (Accuracy for the full scale of the digital output value)	At ambient temperature of 25°C±5°C, within ±0.5% (±20 digit*) At ambient temperature of 0 to 55°C, within ±1.0% (±40 digit*) At ambient temperature of -20 to 0°C*2, within ±1.5% (±60 digit*)
	Conversion speed	30 μs/channels (data refreshed every operation cycle)

Items		Specifications
D/A part	Analog output	0 to 10 V DC (External load resistance value 2 kΩ to 1 MΩ)
	Digital input value	0 to 4000
	Digital input	Unsigned 12-bit binary
	Maximum resolution	2.5 mV
	Precision*3 (Accuracy for the full scale of the analog output value)	At ambient temperature of 25°C±5°C, within ±0.5% (±20 digit*) At ambient temperature of 0 to 55°C, within ±1.0% (±40 digit*) At ambient temperature of -20 to 0°C*2, within ±1.5% (±60 digit*)
	Conversion speed	30 μs (data refreshed every operation cycle)

Items		Input specifications	Output specifications
Common part	Isolation method	Inside the PLC: Non-isolation Between input terminal channels: Non-isolation	Inside the PLC: Non-isolation
	Number of occupied input/output points	0 points (no occupied points)	
	External dimensions W × H × D (mm)	FX5U-32M□: 150 × 90 × 83 FX5U-64M□: 220 × 90 × 83 FX5U-80M□: 285 × 90 × 83	
	MASS (Weight): kg	FX5U-32M□: Approx. 0.70 FX5U-64M□: Approx. 1.00 FX5U-80M□: Approx. 1.20	

\*1: Digit refers to digital values.

\*2: Products manufactured earlier than June 2016 do not support this specification.

\*3: External load resistance is set to 2 kΩ when shipped from the factory. Thus, output voltage will increase somewhat if the resistance is set higher than 2 kΩ.  
When the resistance is 1 MΩ, output voltage increases maximum 2%.

# Input/Output Devices for Voltage and Current





memo

# Input Device for Temperature Sensor

Platinum resistance thermometer sensor (Pt100) or thermocouple temperature sensors can be connected.

FX5-4LC type temperature control module, which provides PID control function with auto tuning, can use a function of intelligent function module to perform temperature control.

## ◇ List of input devices for temperature sensor

Model (Number of channels)	Compatible sensor	Input specifications		Isolation method	Compatible CPU module				Number of channels							
		Items	Temperature input		FX5S	FX5UJ	FX5U	FX5UC								
<b>FX5-4AD-PT-ADP (4 ch)</b> 	Resistance temperature detector Pt100, Ni100	Input range	Pt100: -200 to 850°C Ni100: -60 to 250°C	Between input terminal and PLC: Photocoupler Between input terminal channels: Non-isolation	○	○	○	○	4 ch							
		Resolution	0.1°C													
<b>FX5-4AD-TC-ADP (4 ch)</b> 	Thermocouple K, J, T, B, R, S	Input range	[Typical example] K type: -200 to 1200°C J type: -40 to 750°C	Between input terminal and PLC: Photocoupler Between input terminal channels: Non-isolation	○	○	○	○	4 ch							
		Resolution	0.1°C to 0.3°C (depending on the sensor used)													
<b>FX5-8AD (8 ch)</b> 	Resistance temperature detector Pt100, Ni100	Input range	Pt100: -200 to 850°C Ni100: -60 to 250°C	Between input terminal and PLC: Photocoupler Between input terminal channels: Non-isolation	×	○	○	○*	8 ch							
		Resolution	0.1°C													
	Thermocouple K, J, T, B, R, S	Input range	[Typical example] K type: -200 to 1200°C J type: -40 to 750°C													
		Resolution	0.1°C to 0.3°C (depending on the sensor used)													
<b>FX5-4LC (4 ch)</b> 	Resistance temperature detector 3-wire type Pt100 3-wire type JPt100 2-wire/3-wire type Pt1000	Input range	3-wire type Pt100: -200 to 600°C 3-wire type JPt100: -200 to 500°C 2-wire/3-wire type Pt1000: -200 to 650°C	Between analog input part and PLC: Photocoupler Between transistor output part and PLC: Photocoupler Between analog input part and power supply: Insulation by the DC-DC converter Between transistor output part and power supply: Insulation by the DC-DC converter Between channels: insulated	×	○	○	○*	4 ch							
		Resolution	0.1°C or 1°C (depends on the sensor used)													
	Thermocouple K, J, T, B, R, S, N, PLII, W5Re/W26Re, U, L	Input range	[Typical example] K type: -200 to 1300°C J type: -200 to 1200°C													
		Resolution	0.1°C or 1°C (depending on the sensor used)													
	Micro voltage input	Input range	0 to 10 mV DC, 0 to 100 mV DC													
		Resolution	0.5 μV, 5.0 μV													
	<b>FX3U-4LC (4 ch)</b> 	Resistance temperature detector 3-wire type Pt100 3-wire type JPt100 2-wire/3-wire type Pt1000	Input range							[Typical example] Pt100: -200 to 600°C Pt1000: -200.0 to 650.0°C	Between inside and channels: Photocoupler Between inside and power supply: Insulation by the DC-DC converter Between channels: insulated	×	×	○*2	○*2	4 ch
			Resolution							0.1°C or 1°C (depending on the sensor used)						
Thermocouple K, J, R, S, E, T, B, N, PLII, W5Re/W26Re, U, L		Input range	[Typical example] K type: -200.0 to 1300°C J type: -200.0 to 1200°C													
		Resolution	0.1°C or 1°C (depending on the sensor used)													
Micro voltage input		Input range	0 to 10 mV DC, 0 to 100 mV DC													
		Resolution	0.5 μV, 5.0 μV													

\*1: Connection with FX5UC CPU module requires connector conversion module (FX5-CNV-IFC) or extension power supply module (FX5-C1PS-5V).

\*2: Connection with FX5U/FX5UC CPU module requires bus conversion module (FX5-CNV-BUS or FX5-CNV-BUSC).

## FX5-4AD-PT-ADP resistance temperature detector temperature sensor input expansion adapter

### ◆ Features



- 1) Resistance temperature detector (Pt100, Ni100) temperature sensor input expansion adapter
- 2) Four channels can be measured with high resolution of 0.1°C.
- 3) It is possible to use a combination of temperature sensors for each channel.
- 4) The measurement unit can be expressed in degrees Celsius (°C) or Fahrenheit (°F).
- 5) Data transfer is possible without programming (no dedicated instructions).

### ◆ Specifications

Items		Specifications	
Analog input points		4 points (4 channels)	
Usable resistance temperature detector*1		Pt100 Ni100 (DIN 43760 1987)	
Temperature measuring range	Pt100	-200 to 850°C (-328 to 1562°F)	
	Ni100	-60 to 250°C (-76 to 482°F)	
		16-bit signed binary value	
Digital output value	Pt100	-2000 to 8500 (-3280 to 1562)	
	Ni100	-600 to 2500 (760 to 4820)	
Accuracy	Ambient temperature 25±5°C	Pt100	±0.8°C
		Ni100	±0.4°C
	Ambient temperature -20 to 55°C	Pt100	±2.4°C
		Ni100	±1.2°C
Resolution		0.1°C (0.1 to 0.2°F)	
Conversion speed*2		Approx 85 ms/channel	
Isolation method		Between input terminal and CPU module: Photocoupler Between input terminal channels: Non-isolation	
Power supply		24 V DC, 20 mA (internal power supply)*3 5 V DC, 10 mA (internal power supply)*3	
Compatible CPU module		FX5S, FX5UJ: Compatible from initial product FX5U, FX5UC: Ver. 1.040 or later	
Number of occupied I/O points		0 points (no occupied points)	
Number of connectable modules		FX5S, FX5U, FX5UC: Up to 4 modules to the left side of CPU module, FX5UJ: Up to 2 modules to the left side of CPU module	
External dimensions W × H × D (mm)		17.8 × 106 × 89.1	
MASS (Weight): kg		Approx. 0.1	

\*1: Only 3-wire type resistance temperature detectors can be used.

\*2: For details of conversion speeds, refer to the manual.

\*3: Current consumption calculation is not required for the FX5S/FX5UJ CPU module.

**FX5-4AD-TC-ADP thermocouple temperature sensor input expansion adapter**

◆ Features



- 1) Thermocouple temperature sensor input expansion adapter
- 2) Four channels can be measured with high resolution of 0.1°C.
- 3) It is possible to use a combination of temperature sensors for each channel.
- 4) The measurement unit can be expressed in degrees Celsius (°C) or Fahrenheit (°F).
- 5) Data transfer is possible without programming (no dedicated instructions).

◆ Specifications

Item		Specifications		
Analog input points		4 points (4 channels)		
Applicable thermocouple*1		K, J, T, B, R, S		
Temperature measuring range	K	-200 to 1200°C (-328 to 2192°F)		
	J	-40 to 750°C (-40 to 1382°F)		
	T	-200 to 350°C (-328 to 662°F)		
	B	600 to 1700°C (1112 to 3092°F)		
	R	0 to 1600°C (32 to 2912°F)		
	S	0 to 1600°C (32 to 2912°F)		
Digital output value	16-bit signed binary value			
	K	-2000 to 12000 (-3280 to 21920)		
	J	-400 to 7500 (-400 to 13820)		
	T	-2000 to 3500 (-3280 to 6620)		
	B	6000 to 17000 (11120 to 30920)		
	R, S	0 to 16000 (320 to 29120)		
Accuracy*1	Ambient temperature 25±5°C	K	±3.7°C (-100 to 1200°C)*2	±4.9°C (-150 to -100°C)*2
		J	±2.8°C	
		T	±3.1°C (0 to 350°C)*2	±4.1°C (-100 to 0°C)*2
		B	±3.5°C	
		R	±3.7°C	
		S	±3.7°C	
	Ambient temperature -20 to 55°C	K	±6.5°C (-100 to 1200°C)*2	±7.5°C (-150 to -100°C)*2
		J	±4.5°C	
		T	±4.1°C (0 to 350°C)*2	±5.1°C (-100 to 0°C)*2
		B	±6.0°C (-150 to -100°C)*2	
		R	±6.5°C	
		S	±6.5°C	
Resolution	K, J, T	0.1°C (0.1 to 0.2°F)		
	B, R, S	0.1 to 0.3°C (0.1 to 0.6°F)		
Conversion speed*3		Approx. 85 ms/channel		
Isolation method		Between input terminal and CPU module: Photocoupler Between input terminal channels: Non-isolation		
Power supply		24 V DC, 20 mA (internal power supply)*4 5 V DC, 10 mA (internal power supply)*4		
Compatible CPU module		FX5S, FX5UJ: Compatible from initial product FX5U, FX5UC: Ver. 1.040 or later		
Number of occupied I/O points		0 points (no occupied points)		
Number of connectable modules		FX5S, FX5U, FX5UC: Up to 4 modules to the left side of CPU module, FX5UJ: Up to 2 modules to the left side of CPU module		
External dimensions W × H × D (mm)		17.8 × 106 × 89.1		
MASS (Weight): kg		Approx. 0.1		

\*1: Obtaining sufficient accuracy requires a warm-up of 45 minutes (energization).  
 \*2: Accuracy varies depending on the measured temperature range in ( ).  
 \*3: For details of conversion speeds, refer to the manual.  
 \*4: Current consumption calculation is not required for the FX5S/FX5UJ CPU module.

## FX5-8AD multiple input module

### ◆ Features



- 1) Since a single module can handle input of voltage, current, thermocouple, and resistance temperature detector, there is no need to prepare multiple modules for different objects.
- 2) The module can easily detect a disconnection of the thermocouple or resistance temperature detector, and therefore can reduce the downtime and maintenance cost.
- 3) Data of 10000 points can be logged for each channel and saved in buffer memory. Saving logs will be useful for troubleshooting.

### ◆ Specifications

Item		Specifications	
Analog input points		8 points (8 channels)	
Analog input voltage		-10 to 10 V DC (input resistance 1 MΩ)	
Analog input current		-20 to +20 mA DC (input resistance 250 Ω)	
Absolute maximum input		Voltage: ±15 V, Current: ±30 mA	
Input characteristics, resolution*1	Thermocouple	K, J, T: 0.1°C (0.1 to 0.2°F) B, R, S: 0.1 to 0.3°C (0.1 to 0.6°F)	
	Resistance temperature detector	0.1°C (0.2°F)	
Digital output value (16-bit signed binary value)	Thermocouple	K: -2000 to +12000 (-3280 to +21920) J: -400 to +7500 (-400 to +13820) T: -2000 to +3500 (-3280 to +6620) B: 6000 to 17000 (11120 to 30920) R: 0 to 16000 (320 to 29120) S: 0 to 16000 (320 to 29120)	
	Resistance temperature detector	Pt100: -2000 to +8500 (-3280 to +15620) Ni100: -600 to +2500 (-760 to +4820)	
Accuracy	Thermocouple*2	Ambient temperature 25±5°C	K: ±3.5°C (-200 to -150°C) K: ±2.5°C (-150 to -100°C) K: ±1.5°C (-100 to 1200°C) J: ±1.2°C T: ±3.5°C (-200 to -150°C) T: ±2.5°C (-150 to -100°C) T: ±1.5°C (-100 to 350°C) B: ±2.3°C R: ±2.5°C S: ±2.5°C
		Ambient temperature -20 to 55°C	K: ±8.5°C (-200 to -150°C) K: ±7.5°C (-150 to -100°C) K: ±6.5°C (-100 to 1200°C) J: ±3.5°C T: ±5.2°C (-200 to -150°C) T: ±4.2°C (-150 to -100°C) T: ±3.1°C (-100 to 350°C) B: ±6.5°C R: ±6.5°C S: ±6.5°C
	Resistance temperature detector	Ambient temperature 25±5°C	Pt100: ±0.8°C Ni100: ±0.4°C
		Ambient temperature -20 to 55°C	Pt100: ±2.4°C Ni100: ±1.2°C
Conversion speed	Thermocouple/Resistance temperature detector	40 ms/ch	
Isolation method		Between input terminal and PLC: Photocoupler Between input terminal channels: Non-isolation	
Power supply		24 V DC, 40 mA (internal power supply) 24 V DC +20%, -15% 100 mA (external power supply)	
Compatible CPU module		FX5UJ: Compatible from initial product FX5U, FX5UC: Ver. 1.050 or later Connection with FX5UC CPU module requires connector conversion module (FX5-CNV-IFC) or extension power supply module (FX5-C1PS-5V).	
Applicable engineering tool		FX5UJ: GX Works3 Ver. 1.060N or later FX5U, FX5UC: GX Works3 Ver. 1.025B or later	
Number of occupied I/O points		8 points (Either input or output is available for counting.)	
Number of connectable modules		FX5UJ: Up to 8 modules FX5U: Up to 16 modules FX5UC: Up to 15 modules	
External dimensions W × H × D (mm)		50 × 90 × 102.2	
MASS (Weight): kg		Approx. 0.3	

\*1: For details of input conversion characteristics, refer to the manual.

\*2: To stabilize the accuracy, warm-up (supply power) the system for 30 minutes or more after power-on.



## FX5-4LC temperature control module

### ◆ Features



- 1) Being compatible with the thermocouple, resistance temperature detector, and micro voltage input, the module can be used for a wide range of applications.
- 2) The module can suppress the overshoot in which the output value exceeds the target value or hunting phenomenon which oscillates before and after the target value.
- 3) Since the change in temperature can be checked with the waveform, parameters can be adjusted while checking the waveform displayed in real time.

### ◆ Specifications

Item		Specifications	
Control system		Two-position control, standard PID control, heating/cooling PID control, cascade control	
Control operation cycle		250 ms/4 ch	
Temperature measuring range		Thermocouple	K: -200 to +1300°C (-100 to +2400°F) J: -200 to +1200°C (-100 to +2100°F) T: -200 to +400°C (-300 to +700°F) S: 0 to 1700°C (0 to 3200°F) R: 0 to 1700°C (0 to 3200°F) E: -200 to +1000°C (0 to 1800°F) B: 0 to 1800°C (0 to 3000°F) N: 0 to 1300°C (0 to 2300°F) PLI: 0 to 1200°C (0 to 2300°F) W5Re/W26Re: 0 to 2300°C (0 to 3000°F) U: -200 to +600°C (-300 to +700°F) L: 0 to 900°C (0 to 1600°F)
		Resistance temperature detector	Pt100 (3-wire type): -200 to +600°C (-300 to +1100°F) JPt100 (3-wire type): -200 to +500°C (-300 to +900°F) Pt1000 (2-wire/3-wire type): -200.0 to +650.0°C (-328 to +1184°F)
		Micro voltage input	0 to 10 mV DC, 0 to 100 mV DC
		Heater disconnection detection	Alarm detection
Input specifications	Number of input points	4 points	
	Input type (selectable for each channel)	Thermocouple	K, J, R, S, E, T, B, N, PLI, W5Re/W26Re, U, L
		Resistance temperature detector	3-wire type Pt100 3-wire type JPt100 2-wire/3-wire type Pt1000
		Micro voltage input	
	Measurement accuracy*	Refer to the MELSEC iQ-F FX5 User's Manual (Temperature Control).	
	Cold junction temperature compensation error	Ambient temperature 0 to 55°C	Within ±1.0°C. When the input value is -150 to -100°C: Within ±2.0°C. When the input value is -200 to -150°C: Within ±3.0°C
		Ambient temperature -20 to 0°C	Within ±1.8°C. When the input value is -150 to -100°C: Within ±3.6°C. When the input value is -200 to -150°C: Within ±5.4°C
	Resolution	0.1°C (0.1°F), 1.0°C (1.0°F), 0.5 μV, or 5.0 μV (depends on the input range of the sensor used)	
	Sampling cycle	250 ms/4 ch	
	Influence of input conductor resistance (for resistance temperature detector input)	3-wire type	Approx. 0.03%/Ω for full scale, and 10 Ω or less per line
		2-wire type	Approx. 0.04%/Ω for full scale, and 7.5 Ω or less per line
	Influence of external resistance (for thermocouple input)	About 0.125 μV/Ω	
	Input impedance	1 MΩ or more	
Sensor current	Approx. 0.2 mA (for resistance temperature detector input)		
Operation at input disconnection/short circuit	Upscale/downscale (for resistance temperature detector input)		
Current detector (CT) input specifications	Number of input points	4 points	
	Sampling cycle	0.5 seconds	
Output specifications		Number of points: 4 Type: NPN open collector transistor output, Rated load voltage: 5 to 24 V DC Maximum load current: 100 mA, Control output cycle: 0.5 to 100.0 seconds	
Power supply		5 V DC, 140 mA (internal power supply) 24 V DC +20%, -15% 25 mA (external power supply)	
Isolation method		<ul style="list-style-type: none"> <li>• The analog input part and between the transistor output part and PLC are insulated by the photocoupler.</li> <li>• The analog input part and between the transistor output part and power supply are insulated by the DC/DC converter.</li> <li>• Insulated between channels</li> </ul>	
Compatible CPU module		FX5UJ: Compatible from initial product FX5U, FX5UC: Ver. 1.050 or later Connection with FX5UC CPU module requires connector conversion module (FX5-CNV-IFC) or extension power supply module (FX5-C1PS-5V).	
Applicable engineering tool		FX5UJ: GX Works3 Ver. 1.060N or later FX5U, FX5UC: GX Works3 Ver. 1.035M or later	
Number of occupied I/O points		8 points (Either input or output is available for counting.)	
Number of connectable modules		FX5UJ: Up to 8 modules FX5U: Up to 16 modules FX5UC: Up to 15 modules	
External dimensions W × H × D (mm)		60 × 90 × 102.2	
MASS (Weight): kg		Approx. 0.3	

\*: To stabilize the measurement accuracy, warm-up (supply power) the system for 30 minutes or more after power-on.

## FX3U-4LC temperature control block

### ◆ Features



- 1) The module provides 4-ch temperature sensor input and control output through which "two-position control, standard PID control (auto-tuning possible), heating/cooling PID control, and cascade control" can be carried out. It can also be used in combination with an analog input/output module to perform PID control by voltage and current.
- 2) The module is newly equipped with cascade control. With two control loops of master and slave, the module can quickly adjust the temperature against temperature change due to disturbance or the like.
- 3) Heating/cooling PID control of up to 4 loops can be performed by output operation of 2 systems (heating output and cooling output). Temperature control can be achieved with high stability in both the heating and cooling sides.
- 4) Micro voltage signals such as "0-10 mV DC" and "0-100 mV DC" can be input. Sensors such as micro voltage output sensor can directly be connected.
- 5) The module supports a wide range of thermocouple temperature sensor and high-precision Pt1000 temperature sensor.

### ◆ Specifications

Items		Specifications
Control system		Two-position control, standard PID control, heating/cooling PID control, and cascade control
Control operation cycle		250 ms/4 ch
Setting temperature range*1		Thermocouple K: -200.0 to 300°C (-100 to 400°F) J: -200.0 to 200°C (-100 to 100°F)
		Resistance temperature detector Pt100 (3-wire type): -200.0 to 00.0°C (-300.0 to 100°F) Pt1000 (2-wire/3-wire type): -200.0 to 50.0°C (-328 to 184°F)
		Micro voltage input 0 to 10 mV DC, 0 to 100 mV DC
Heater disconnection detection		Detection of alarm by buffer memory (variable in the range from 0.0 to 100.0 A)
Input specifications	No. of input points	4 points
	Type of input (selectable for each channel)	[Resistance temperature detector] 3-wire type Pt100 3-wire type JPt100 2-wire/3-wire type Pt1000 [Thermocouple] K, J, R, S, E, T, B, N, PLII, W5Re/W26Re, U, L [Micro voltage input] 0 to 10 mV DC, 0 to 100 mV DC
	Example of measurement accuracy*1*2	[At ambient temperature 25°C±5°C] K type thermocouple input range is 500°C or more: Displayed value ±0.3% ±1 digit*3 [At ambient temperature 0 to 55°C] K type thermocouple input range is 500°C or more: Displayed value ±0.7% ±1 digit*3
	Example of resolution*1	0.1°C (0.1°F), 1°C (1°F), 0.5 μV, or 5.0 μV
	Sampling cycle	250 ms/4 ch
	Operation at the time of input disconnection/short-circuit	Up scale/down scale (at the time of resistance thermometer sensor input)
Current detector (CT) input specification		Number of points: 4 Current detector: CTL-12-S36-8, CTL-12-S56-10, CTL-6-P-H (manufactured by U.R.D. Ltd.), sampling cycle: 0.5 sec.
Output specifications		Number of points: 4 Type: NPN open collector transistor, Rated load voltage: 5 to 24 V DC, Maximum load current: 100 mA, Control output cycle: 0.5 to 100.0 sec.
Power supply		5 V DC 160 mA (Internal power supply) 24 V DC +20% -15% 50 mA (external power feed from terminal block)
Isolation method		• The analog input part and between the transistor output part and PLC are insulated by the photocoupler. • The analog input part and between the transistor output part and power supply are insulated by the DC/DC converter. • Insulated between channels
Compatible CPU module		FX5U, FX5UC: Compatible from initial product Connection with FX5U/FX5UC CPU module requires bus conversion module (FX5-CNV-BUS or FX5-CNV-BUSC).
Number of occupied input/output points		8 points (Either input or output is available for counting.)
Communication with PLC		Carried out by FROM/TO instruction via buffer memory (buffer memory can directly be specified)
Number of connectable modules		FX5U: Up to 8 modules when FX3U extension power supply modules are used Up to 6 modules when FX3U extension power supply modules are not used FX5UC: Up to 6 modules
External dimensions W × H × D (mm)		90 × 90 × 86
MASS (Weight): kg		Approx. 0.4

\*1: Differs depending on the sensor input range.

\*2: To stabilize the measurement accuracy, warm-up (supply power) the system for 30 minutes or more after power-on.

\*3: Digit refers to digital values.

# High-Speed Counter

Using high-speed counters allow PLC to capture high-speed signals from encoders and sensors. Since the CPU module has built-in high performance high-speed counters, high-speed control is possible with simple programs.

## List of high-speed counters

### ◆ Built-in high-speed counter functions of CPU module\*1





















Model	Type	Maximum frequency		Operation mode	High-speed processing instruction
		FX5S/FX5UJ	FX5U/FX5UC		
	1-phase, 1-input (S/W)	100 kHz*2	200 kHz	<ul style="list-style-type: none"> <li>• Normal mode</li> <li>• Pulse density measurement mode</li> <li>• Rotation speed measurement mode</li> </ul>	<ul style="list-style-type: none"> <li>• 32-bit data comparison set</li> <li>• 32-bit data comparison reset</li> <li>• 32-bit data band comparison</li> <li>• 16-bit data high-speed input/output function start/stop</li> <li>• 32-bit data high-speed input/output function start/stop</li> </ul>
	1-phase, 1-input (H/W)	100 kHz*2	200 kHz		
	1-phase, 2-input	100 kHz	200 kHz		
	2-phase, 2-input [1 edge count]	100 kHz	200 kHz		
	2-phase, 2-input [2 edge count]	50 kHz	100 kHz		
	2-phase, 2-input [4 edge count]	25 kHz	50 kHz		
	Internal clock	1 MHz (fixed)	1 MHz (fixed)		

\*1: For the details of the high-speed counter functions, refer to the manual.

\*2: 1-phase, 1-input 100 kHz: 4 ch, 10 kHz: 4 ch

### ◆ High-speed counter of FX5S/FX5UJ/FX5U/FX5UC CPU module

High-speed counters use parameters to make input allocation and function settings and use HIOEN instruction to perform operations.

Types of high-speed counters		Pulse input signal type	
1-phase, 1-input counter (S/W)		Input A phase ON  OFF Counting Direction Switching Bit OFF  ON	
1-phase, 1-input counter (H/W)		Input A phase ON  OFF Input B phase (input for switching the counting direction) OFF  ON	
1-phase, 2-input counter		Input A phase (Up-Counting Input from OFF to ON: +1) ON  OFF Input B phase (Down-Counting Input from OFF to ON: -1) ON  OFF	
2-phase, 2-input counter	1 edge count	At Up-Counting Input A phase  +1 Input B phase  +1 At Down-Counting Input A phase  -1 Input B phase  -1	
	2 edge count	At Up-Counting Input A phase  +1 Input B phase  +1 At Down-Counting Input A phase  -1 Input B phase  -1	
	4 edge count	At Up-Counting Input A phase  +1 Input B phase  +1 At Down-Counting Input A phase  -1 Input B phase  -1	
Internal clock		Counting Direction Switching Bit OFF  ON Internal Clock (1 MHz) ON  OFF	

# High-Speed Counter

## ◇ Built-in high-speed counter input allocation

Parameter is used to set the input device allocation of high-speed counters.

Parameter is used to set the function for each channel, and input device allocation is determined by the settings.

When internal clock is used, the allocation is the same as that of 1-phase, 1-input (S/W), without using phase A.

### ● FX5S/FX5UJ CPU module

CH	Type of high-speed counter	X0	X1	X2	X3	X4	X5	X6	X7	X10	X11	X12	X13	X14	X15	X16	X17
CH1	1-phase, 1-input (S/W)	A	P					E									
	1-phase, 1-input (H/W)	A	B	P				E									
	1-phase, 2-input	A	B	P				E									
	2-phase, 2-input	A	B	P				E									
CH2	1-phase, 1-input (S/W)		A	P					E								
	1-phase, 1-input (H/W)		A	B	P				E								
	1-phase, 2-input		A	B	P				E								
CH3	1-phase, 1-input (S/W)			A	P					E							
	1-phase, 1-input (H/W)			A	B	P				E							
	1-phase, 2-input			A	B	P				E							
CH4	1-phase, 1-input (S/W)				A	P					E						
	1-phase, 1-input (H/W)				A	B	P				E						
	1-phase, 2-input				A	B	P				E						
	2-phase, 2-input				A	B	P				E						
CH5	1-phase, 1-input (S/W)					A	P					E					
	1-phase, 1-input (H/W)					A	B	P				E					
	1-phase, 2-input					A	B	P				E					
CH6	1-phase, 1-input (S/W)						A	P					E				
	1-phase, 1-input (H/W)						A	B	P				E				
	1-phase, 2-input						A	B	P				E				
	2-phase, 2-input						A	B	P				E				
CH7	1-phase, 1-input (S/W)							A	P					E			
	1-phase, 1-input (H/W)							A	B	P				E			
	1-phase, 2-input							A	B	P				E			
	2-phase, 2-input							A	B	P				E			
CH8	1-phase, 1-input (S/W)								A	P					E		
	1-phase, 1-input (H/W)								A	B	P				E		

A: Input A phase (In the case of 1-phase 1-input, pulse input is employed and in the case of 1-phase 2-input, pulse input of down-counting direction is employed.)

B: Input B phase (In the case of 1-phase 1-input (H/W), direction switch input is employed and in the case of 1-phase 2-input, pulse input of down-counting direction is employed.)

P: Input external preset

E: Input external enable

● FX5U/FX5UC CPU module

CH	Type of high-speed counter	X0	X1	X2	X3	X4	X5	X6	X7	X10	X11	X12	X13	X14	X15	X16	X17
CH1	1-phase, 1-input (S/W)	A								P	E						
	1-phase, 1-input (H/W)	A	B							P	E						
	1-phase, 2-input	A	B							P	E						
	2-phase, 2-input	A	B							P	E						
CH2	1-phase, 1-input (S/W)		A									P	E				
	1-phase, 1-input (H/W)			A	B							P	E				
	1-phase, 2-input			A	B							P	E				
	2-phase, 2-input			A	B							P	E				
CH3	1-phase, 1-input (S/W)			A										P	E		
	1-phase, 1-input (H/W)					A	B							P	E		
	1-phase, 2-input					A	B							P	E		
	2-phase, 2-input					A	B							P	E		
CH4	1-phase, 1-input (S/W)				A											P	E
	1-phase, 1-input (H/W)							A	B							P	E
	1-phase, 2-input							A	B							P	E
	2-phase, 2-input							A	B							P	E
CH5	1-phase, 1-input (S/W)					A				P	E						
	1-phase, 1-input (H/W)									A	B	P	E				
	1-phase, 2-input									A	B	P	E				
	2-phase, 2-input									A	B	P	E				
CH6	1-phase, 1-input (S/W)						A					P	E				
	1-phase, 1-input (H/W)											A	B	P	E		
	1-phase, 2-input											A	B	P	E		
	2-phase, 2-input											A	B	P	E		
CH7	1-phase, 1-input (S/W)							A						P	E		
	1-phase, 1-input (H/W)													A	B	P	E
	1-phase, 2-input													A	B	P	E
	2-phase, 2-input													A	B	P	E
CH8	1-phase, 1-input (S/W)								A							P	E
	1-phase, 1-input (H/W)															A	B
	1-phase, 2-input															A	B
	2-phase, 2-input															A	B
CH1 to CH8	Internal clock	Not used															

A: Input A phase  
 B: Input B phase (direction switch input is however employed in the case of 1-phase 1-input [H/W])  
 P: Input external preset (Use or nonuse can be selected for each channel using parameters.)  
 E: Input external enable (Use or nonuse can be selected for each channel using parameters.)

# High-Speed Counter

## ◇ High-speed pulse input/output module

Model	Type	Maximum frequency	Operation mode	High-speed processing instruction	Compatible CPU module			
					FX5S	FX5UJ	FX5U	FX5UC
 <b>FX5-16ET/ES-H</b> <b>FX5-16ET/ESS-H</b>	1-phase, 1-input (S/W)	200 kHz	<ul style="list-style-type: none"> <li>• Normal mode</li> </ul>	<ul style="list-style-type: none"> <li>• 16-bit data high-speed input/output function start/stop</li> <li>• 32-bit data high-speed input/output function start/stop</li> </ul>	×	○	○	○*
	1-phase, 1-input (H/W)	200 kHz						
	1-phase, 2-input	200 kHz						
	2-phase, 2-input [1 edge count]	200 kHz						
	2-phase, 2-input [2 edge count]	100 kHz						
	2-phase, 2-input [4 edge count]	50 kHz						
	Internal clock	1 MHz (fixed)						

\*: Connection with FX5UC CPU module requires connector conversion module (FX5-CNV-IFC) or extension power supply module (FX5-C1PS-5V).

## ◇ Input assignment and the maximum frequency for each input assignment of the high-speed pulse input/output module

“□” of each input represents the prefix input number of the high-speed pulse input/output module.

“X□+6” and “X□+7” are input frequencies up to 10 kHz, regardless of maximum frequency value.

Preset input and enable input are input frequencies up to 10 kHz, regardless of maximum frequency value.

CH	High-speed counter type	X□	X□+1	X□+2	X□+3	X□+4	X□+5	X□+6	X□+7	Maximum frequency
CH9, CH11, CH13, CH15	1-phase, 1-input (S/W)	A	P					E		200 kHz
	1-phase, 1-input (H/W)	A	B	P				E		200 kHz
	1-phase, 2-input	A	B	P				E		200 kHz
	2-phase, 2-input [1 edge count]	A	B	P				E		200 kHz
	2-phase, 2-input [2 edge count]	A	B	P				E		100 kHz
	2-phase, 2-input [4 edge count]	A	B	P				E		50 kHz
CH10, CH12, CH14, CH16	1-phase, 1-input (S/W)				A	P			E	200 kHz
	1-phase, 1-input (H/W)				A	B	P		E	200 kHz
	1-phase, 2-input				A	B	P		E	200 kHz
	2-phase, 2-input [1 edge count]				A	B	P		E	200 kHz
	2-phase, 2-input [2 edge count]				A	B	P		E	100 kHz
	2-phase, 2-input [4 edge count]				A	B	P		E	50 kHz
CH9 to CH16	Internal clock	Not used								

A: Input A phase  
 B: Input B phase (direction switch input is however employed in the case of 1-phase 1-input [H/W])  
 P: Input external preset (Use or nonuse can be selected for each channel using parameters.)  
 E: Input external enable (Use or nonuse can be selected for each channel using parameters.)

## ◇ High-speed counter block

Model (Number of channels)	Type	Highest response frequency	Function	Hardware comparison output function	2-phase counter edge count function	Compatible CPU module			
						FX5S	FX5UJ	FX5U	FX5UC
 <b>FX3U-2HC (2 ch)</b>	1-phase 1-input	Max. 200 kHz	With match output (delay of up to 30 μs) function Output type: Output common to sink/source 2 points/channel	○	-	×	×	○*	○*
	1-phase 2-input	Max. 200 kHz							
	2-phase 2-input	1 edge count: Max. 200 kHz 2 edge count: Max. 100 kHz 4 edge count: Max. 50 kHz							

\*: Connection with FX5U/FX5UC CPU module requires bus conversion module (FX5-CNV-BUS or FX5-CNV-BUSC).

## FX3U-2HC high-speed counter block

### ◆ Features



- 1) Input of 2-ch high-speed signal can be made in a module to count a maximum of 200 kHz. Each channel is equipped with 2 high-speed output terminal points based on the setting of comparison value received from CPU module.
- 2) In 2-phase input, 1/2/4 edge count mode can be set.
- 3) Counting can be permitted/inhibited in CPU module or external input.
- 4) Connection with an encoder of line driver output type can be made.
- 5) I/O signal connection adopts a connector system and is compact.

### ◆ Specifications

Items	Specifications
No. of input points	2 points
Signal level	According to connection terminals, 5 V DC, 12 V DC and 24 V DC are selectable. The line driver output type is connected to the 5 V terminal.
Frequency	1-phase, 1-input: 200 kHz or less 1-phase, 2-input: 200 kHz or less 2-phase, 2-input: 200 kHz or less/1 edge count, 100 kHz or less/2 edge count, 50 kHz or less/4 edge count
Counting range	Binary signed 32 bits (-2,147,483,648 to +2,147,483,647) or binary unsigned 16 bits (0 to 65,535)
Count mode	Automatic up/down (with 1-phase 2-input or 2-phase input, or selected up/down with 1-phase 1-input)
Match output	When the current value of the counter matches a comparison set value, comparison output is set within 30 μs (ON), and cleared (OFF) within 100 μs by reset instruction.
Output type	2 points/ch, 5 to 24 V DC 0.5 A (output common to sink/source)
Additional function	Buffer memory is available to set mode and comparison data from the CPU module. Current value, comparison results, and error status can be monitored via the CPU module.
Current consumption	5 V DC 245 mA (Internal power supply)
Compatible CPU module	FX5U, FX5UC: Compatible from initial product Connection with FX5U/FX5UC CPU module requires bus conversion module (FX5-CNV-BUS or FX5-CNV-BUSC).
Number of occupied input/output points	8 points (Either input or output is available for counting.)
Communication with PLC	Carried out by FROM/TO instruction via buffer memory (buffer memory can directly be specified)
Number of connectable modules	FX5U, FX5UC: Up to 2 modules
External dimensions W × H × D (mm)	55 × 90 × 87
MASS (Weight): kg	Approx. 0.2

### ◆ Option

Connector for discrete wires (40-pin)

Model name	Type
FX-I/O-CON2-S	Connector for single wires AWG22 (0.3 mm <sup>2</sup> )
FX-I/O-CON2-SA	Connector for single wires AWG20 (0.5 mm <sup>2</sup> )

External device connection connectors and connection cables etc. are not included with the product. Please arrange them by the customer.

## FX5-16ET/E□-H high-speed pulse input/output module

### ◆ Features

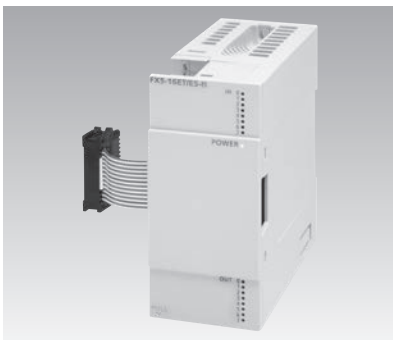

- 1) Input of high-speed pulses can be counted (2 ch, 200 kHz).
- 2) The high-speed counter function and the positioning function can be used together (2 ch + 2 axes). The terminals not assigned to high-speed input/output can be used as general-purpose inputs/outputs.

### ◆ Specifications

Items	Specifications
High-speed pulse input	2 ch
Input response frequency	X□ to X□+5* X□+6, X□+7*
Power supply	5 V DC, 100 mA (internal power supply) 24 V DC, 125 mA (supplied from service power supply or external power supply)
Compatible CPU module	FX5UJ, FX5U, FX5UC from Ver. 1.030 Connection with FX5UC CPU module requires connector conversion module (FX5-CNV-IFC) or extension power supply module (FX5-C1PS-5V).
Applicable engineering tool	FX5UJ: GX Works3 Ver. 1.085P or later FX5U, FX5UC: GX Works3 Ver. 1.025B or later
Number of connectable modules	FX5UJ, FX5U, FX5UC: Up to 4 modules
External dimensions W × H × D (mm)	40 × 90 × 83
MASS (Weight): kg	Approx. 0.25

\*: "□" represents the prefix input number of each high-speed pulse input/output module.



# High-Speed Counter

memo

# Positioning Control

In addition to CPU module built-in positioning instructions, a pulse output module has been prepared to achieve full-scale positioning control. Furthermore, simple motion modules, which can perform complicated control as well as even multi-axis/interpolation control, are lined up to support positioning control.

## List of positioning control

### ◇ Built-in pulse output function of CPU module

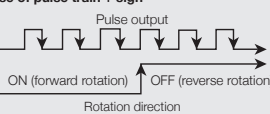
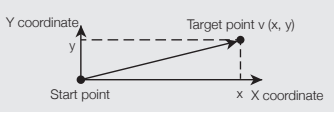
Model/feature	Items	Function
<b>FX5S/FX5UJ/FX5U/FX5UC</b>  <b>In case of pulse train + sign</b>  <b>Simple linear interpolation (2-axis simultaneous start)</b>  This module has a built-in 4-axis*1 high-speed pulse output and built-in positioning function with 8 input channels and 4-axis*1 pulse output.	Number of control axes	FX5UJ: 3 axes FX5S, FX5U, FX5UC: 4 axes*2 (Simple linear interpolation by 2-axis simultaneous start)
	Maximum frequency	FX5S: 100 kpps (100 kpps in pulses) FX5UJ, FX5U, FX5UC: 200 kpps (200 kpps in pulses)
	Positioning program	Sequence program, Table operation
	Compatible CPU module	Transistor output type
	Pulse output instruction	PLSY and DPLSY instructions
	Positioning instruction	DSZR, DDSZR, DVIT, DDVIT, TBL, DRVTBL, DRVMUL, DABS, PLSV, DPLSV, DRVI, DDRVI, DRVA, and DDRVA instructions

\*1: 3 axes in the FX5UJ CPU module.



\*2: The number of control axes is 2 when the pulse output mode is CW/CCW mode.

### ◇ High-speed pulse input/output module

Model/feature	Items	Function	Compatible CPU module			
			FX5S	FX5UJ	FX5U	FX5UC
<b>FX5-16ET/ES-H</b> <b>FX5-16ET/ESS-H</b>  Up to 200 kpps pulse output is possible. Because various positioning operation modes are supported, the module is suitable for 2-axis simple positioning.	Number of control axes	2 axes (Simple linear interpolation by 2-axis simultaneous start)				
	Maximum frequency	200 kpps (200 kpps in pulses)				
	Positioning program	Sequence program, Table operation				
	Output type	FX5-16ET/ES-H: Transistor output (Sink type) FX5-16ET/ESS-H: Transistor output (Source type)	×	○	○	○*
	Pulse output instruction	—				
	Positioning instruction	DSZR, DDSZR, DVIT, DDVIT, DRVTBL, DRVMUL, DABS, PLSV, DPLSV, DRVI, DDRVI, DRVA, and DDRVA instructions				

\*: Connection with FX5UC CPU module requires connector conversion module (FX5-CNV-IFC) or extension power supply module (FX5-C1PS-5V).

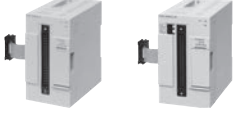
## ◇ Pulse output module

Model/feature	Items	Function		Compatible CPU module			
		FX5-20PG-P	FX5-20PG-D	FX5S	FX5UJ	FX5U	FX5UC
<b>FX5-20PG-P</b> <b>FX5-20PG-D</b>  <p>Two-axis positioning module equipped with linear interpolation and circular interpolation. By analyzing the positioning data in advance, it can start the positioning at high-speeds.</p>	Number of control axes	2 axes		×	○	○	○*1
	Interpolation	2-axis linear interpolation, 2-axis circular interpolation					
	Output type	Transistor	Differential driver				
	Pulse output type	PULSE/SIGN mode, CW/CCW mode Phase A/B (4 multiplication), phase A/B (1 multiplication)					
	Command speed	200 kpps	5 Mpps				
	Control system	PTP (Point To Point) control, path control (both linear and arc configurable), speed control, speed/position switching control, position/speed switching control					
	Positioning program	Sequence program					
	Positioning data	600 data/axis					
	Number of occupied I/O points	8 points (Either input or output is available for counting.)					
	<b>FX3U-1PG</b>  <p>Up to 200 kpps pulse output is possible. Because various positioning operation modes are supported the module is suitable for 1-axis simple positioning.</p>	Number of control axes	1 axis				
Interpolation function		—					
Command speed		200 kpps					
Output type		Transistor					
Pulse output type		Forward rotation pulse/reverse rotation pulse, or pulse train + direction					
Manual pulse generator connection		—					
Positioning program		Sequence program (FROM/TO instruction)					
ABS current value read		Allowed by a sequence program					
Number of occupied input/output points		8 points (Either input or output is available for counting.)					

\*1 : Connection with FX5UC CPU module requires connector conversion module (FX5-CNV-IFC) or extension power supply module (FX5-C1PS-5V).

\*2 : Connection with FX5U/FX5UC CPU module requires bus conversion module (FX5-CNV-BUS or FX5-CNV-BUSC).

## ◇ Simple motion module

Model/feature	Items	Function		Compatible CPU module			
		FX5-40SSC-S	FX5-80SSC-S	FX5S	FX5UJ	FX5U	FX5UC
<b>FX5-40SSC-S</b> <b>FX5-80SSC-S</b>  <p>High-speed/high-precision positioning can be achieved in combination with MELSERVO-J4 series servo amplifiers which are compatible with SSCNET III/H. Parameter settings and table operation settings can easily be made with GX Works3.</p>	Number of control axes	4 axes	8 axes	×	○*1	○	○*2
	Interpolation function	2-axis, 3-axis, 4-axis linear interpolation 2-axis circular interpolation					
	Control system	PTP (Point To Point) control, Trajectory control (both linear and arc), Speed control, Speed-position switching control, Position-speed switching control, Speed-torque control					
	Mark detection function	Regular mode, Specified Number of Detections mode, Ring Buffer mode Mark detection signal: up to 4 points, mark detection setting: 16 settings					
	Digital oscilloscope function*3	Bit data: 16 ch, Word data: 16 ch					
	Servo amplifier connection method	SSCNET III/H					
	Manual pulse generator connection	Possible to connect 1 module					
	Positioning program	Sequence program					
	Number of occupied input/output points	8 points (Either input or output is available for counting.)					

\*1: Only 1 module may be connected per system.

\*2: Connection with FX5UC CPU module requires connector conversion module (FX5-CNV-IFC) or extension power supply module (FX5-C1PS-5V).

\*3: 8 ch word data and 8 ch bit data can be displayed in real time.

◇ Motion module

Model/feature	Items	Function		Compatible CPU module			
		FX5-40SSC-G	FX5-80SSC-G	FX5S	FX5UJ	FX5U	FX5UC
<b>FX5-40SSC-G</b> <b>FX5-80SSC-G</b>  <p>The functions of the CC-Link IE TSN-compatible MELSERVO-J5 series of high-performance servo amplifiers can be used. Also the programs of the simple motion modules can be used. Parameter settings and table operation settings can easily be made with GX Works3.</p>	Number of control axes	4 axes	8 axes				
	Interpolation function	2-axis, 3-axis, 4-axis linear interpolation 2-axis circular interpolation					
	Control system	PTP (Point To Point) control, Trajectory control (both linear and arc), Speed control, Speed-position switching control, Position-speed switching control, Speed-torque control					
	Mark detection function	Regular mode, Specified Number of Detections mode, Ring Buffer mode Mark detection signal: up to 4 points, mark detection setting: 16 settings		×	×	○	○*1
	Digital oscilloscope function*2	Bit data: 16 ch, Word data: 16 ch					
	Servo amplifier connection method	CC-Link IE TSN					
	Manual pulse generator connection	Possible to connect 1 module (via CPU)					
	Positioning program	Sequence program					
	Number of occupied input/output points	8 points (Either input or output is available for counting.)					

\*1: Connection with FX5UC CPU module requires connector conversion module (FX5-CNV-IFC) or extension power supply module (FX5-C1PS-5V).

\*2: 8 ch word data and 8 ch bit data can be displayed in real time.

## ◆ List of positioning operation modes

To confirm detailed operation of each module, refer to manuals of the product.

Positioning instruction Operation pattern	Details	FX5S, FX5U, FX5UC	FX5UJ	FX5-16ET/ES-H, FX5-16ET/ESS-H	FX5-20PG-P, FX5-20PG-D	FX3U-1PG	FX5-40SSC-S, FX5-80SSC-S, FX5-40SSC-G, FX5-80SSC-G
<b>◆ JOG operation</b> 	While the forward rotation/reverse rotation instruction input is ON, the motor performs forward rotation/reverse rotation.	○ *1	○ *1	○ *1	○	○	○
<b>◆ Machine home position return</b> 	The module starts operation at a home position return speed according to the machine home position return start instruction and then outputs clear signal after the end of machine home position return.	○ *2	○ *2	○ *2	○ *2*3	○ *2*3	○ *2*4
<b>◆ 1-speed positioning</b> 	The module starts operation at an operation speed according to start instruction and then decelerates and stops at a target position.	○	○	○	○	○	○
<b>◆ 2-speed operation (2-speed positioning)</b> 	The module moves at operation speed (1) for amount of movement (1) and then moves at operation speed (2) for amount of movement (2) according to start instruction.	○ *5	○ *5	○ *5	○	○	○
<b>◆ Multi-speed operation</b> 	Multi-speed operation can be achieved by performing continuous trajectory control of multiple tables. The diagram at left shows continuous trajectory control of 3 tables.	○ *5	○ *5	○ *5	○	×	○
<b>◆ Interrupt stop</b> 	When interrupt input is ON, the module decelerates and stops.	○	○	○	×	○	×
<b>◆ Interrupt and 1-speed positioning (interrupt and 1-speed pitch feed)</b> 	When the interrupt input turns ON after the start of operation, the object moves the specified distance and decelerates to stop.	○	○	○	○	○	○
<b>◆ Interrupt and 2-speed positioning (interrupt and 2-speed pitch feed)</b> 	When the interrupt input (1) turns ON, the speed is changed to the second speed. In addition, when the interrupt input (2) turns ON, the object moves the specified distance and decelerates to stop.	○ *6	○ *6	○ *6	○ *7	○	○ *7

- \*1: Can be substituted by variable speed operation instruction.
- \*2: Dog search function available.
- \*3: Count type, and data set type function available.
- \*4: Count type, scale origin signal detection type, and data set type function available.
- \*5: Can be substituted by 1-speed positioning table operation.
- \*6: Can be substituted by variable speed operation or interrupt 1-speed positioning operation.
- \*7: Can be substituted by speed-position switching control and speed change function.

Positioning instruction Operation pattern	Details	FX5S, FX5U, FX5UC	FX5UJ	FX5-16ET/ES-H, FX5-16ET/ESS-H	FX5-20PG-P, FX5-20PG-D	FX3U-1PG	FX5-40SSC-S, FX5-80SSC-S, FX5-40SSC-G, FX5-80SSC-G																
<p>◆ Interrupt 2-speed positioning (external instruction positioning)</p>	<p>When the interrupt input turns ON, the speed is changed to the second speed. When an external instruction is turned ON, the object decelerates to stop.</p>	○ *1	○ *1	○ *1	×	○	×																
<p>◆ Variable speed operation</p>	<p>The module operates at the operation speed specified from PLC.</p>	○	○	○	○	○	○																
<p>◆ Linear interpolation</p>	<p>The module moves to the target position at the specified speed. For the speed, composite speed and reference axis speed are selectable.</p>	○ *2	×	○ *2	○	×	○																
<p>◆ Circular interpolation</p>	<p>The module moves to the target position (x, y) at the peripheral speed according to circular interpolation control. Operation can be performed according to sub point designation or center point designation.</p>	×	×	×	○	×	○																
<p>◆ Table operation</p> <table border="1"> <thead> <tr> <th>No.</th> <th>Position</th> <th>Speed</th> <th>.....</th> </tr> </thead> <tbody> <tr> <td>1</td> <td>200</td> <td>500</td> <td></td> </tr> <tr> <td>2</td> <td>500</td> <td>1000</td> <td></td> </tr> <tr> <td>3</td> <td>1000</td> <td>2000</td> <td></td> </tr> </tbody> </table>	No.	Position	Speed	.....	1	200	500		2	500	1000		3	1000	2000		<p>A table is available to create a program for positioning control.</p>	○	○	○	○	×	○
No.	Position	Speed	.....																				
1	200	500																					
2	500	1000																					
3	1000	2000																					
<p>◆ Pulse generator input operation</p>	<p>External pulse can be input from the manual pulse generator input terminal. Synchronous ratio operation using an encoder etc., can be performed.</p>	×	×	×	○	×	○																

\*1: Can be substituted by variable speed operation or interrupt 1-speed positioning operation.  
\*2: Simple linear interpolation only.

## Built-in positioning function of FX5S/FX5UJ/FX5U/FX5UC CPU module

### ◆ Features



- 1) Can position up to 4 axes\*<sup>2</sup> using transistor outputs (Y0, Y1, Y2 and Y3) of the CPU module.
- 2) Can output pulse trains of 200 kpps\*<sup>3</sup> maximum.
- 3) Can realize a reasonable system configuration because the intelligent function module for positioning is not required.
- 4) Change of the speed and positioning address can be made during positioning operation.
- 5) Supports the simple linear interpolation operation.\*<sup>4</sup>

\*1: When the pulse output mode is CW/CCW, the 2 axes.  
 \*2: Up to 3 axes with the FX5UJ CPU module  
 \*3: Up to 100 kpps with the FX5S CPU module  
 \*4: Supported only by the FX5S/FX5U/FX5UC CPU module.

### ◆ Specifications

Items	Specifications
Number of control axes	FX5UJ: 3 axes FX5S, FX5U, FX5UC: 4 axes* <sup>1</sup> (Simple linear interpolation possible by 2-axis simultaneous start)
Maximum frequency	FX5S: 100 kpps (100 kpps in pulses) FX5UJ, FX5U, FX5UC: 200 kpps (200 kpps in pulses)
Positioning program	Sequence program, Table operation
Compatible CPU module	Transistor output type
Pulse output instruction	PLSY and DPLSY instructions
Positioning instruction	DSZR, DDSZR, DVIT, DDVIT, TBL, DRVTBL, DRVMUL, DABS, PLSV, DPLSV, DRVI, DDRVI, DRVA, and DDRVA instructions

[Example of Packaging System Using built-in positioning]

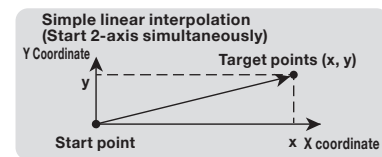
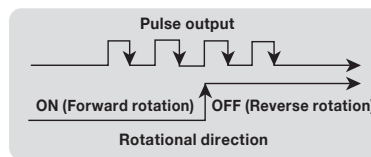
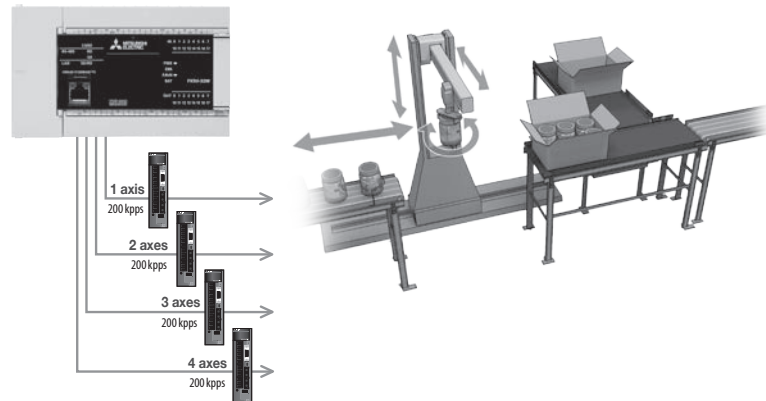



## FX5-16ET/E□-H high-speed pulse input/output module

### ◆ Features



- 1) Can extend the high-speed counter function (2 ch) and positioning function (2 axes) at the same time, and realize a reasonable system configuration.
- 2) Offers easy extension in the same way as the positioning function built in the CPU module.
- 3) Can output pulse trains of 200 kpps maximum.
- 4) Allows terminals not using the high-speed counter function or positioning function to be used for general-purpose inputs/outputs.

### ◆ Specifications

Items	Specifications
Number of control axes	2 axes (Simple linear interpolation by 2-axis simultaneous start)
Maximum frequency	200 kpps (200 kpps in pulses)
Positioning program	Sequence program, Table operation
Output type	FX5-16ET/ES-H: Transistor output (Sink type) FX5-16ET/ESS-H: Transistor output (Source type)
Pulse output instruction	—
Positioning instruction	DSZR, DDSZR, DVIT, DDVIT, DRVTBL, DRVMUL, DABS, PLSV, DPLSV, DRVI, DDRVI, DRVA, and DDRVA instructions
Power supply	5 V DC, 100 mA (internal power supply) 24 V DC, 125 mA (supplied from service power supply or external power supply)
Compatible CPU module	FX5UJ, FX5U, FX5UC from Ver. 1.030 Connection with FX5UC CPU module requires connector conversion module (FX5-CNV-IFC) or extension power supply module (FX5-C1PS-5V)..
Applicable engineering tool	FX5UJ: GX Works3 Ver. 1.085P or later FX5U, FX5UC: GX Works3 Ver. 1.025B or later
Number of connectable modules	FX5UJ, FX5U, FX5UC: Up to 4 modules
External dimensions W × H × D (mm)	40 × 90 × 83
MASS (Weight): kg	Approx. 0.25

## FX5-20PG-P 2-axis pulse train positioning module (transistor output) FX5-20PG-D 2-axis pulse train positioning module (differential line driver output)

### ◆ Features



- 1) By analyzing the positioning data in advance, the module can start the positioning at a higher speed than the normal positioning start.
- 2) It can easily draw the smooth path by combining linear interpolation, 2-axis circular interpolation, and continuous path control in a point table method program.
- 3) Acceleration/deceleration processing can be selected from two methods of trapezoidal and S-shaped acceleration/deceleration, and four kinds each of acceleration time and deceleration time can be set. In the case of S-shaped acceleration/deceleration, the S-character ratio can also be set.

### ◆ Specifications

Items	Specifications	
	FX5-20PG-P	FX5-20PG-D
Number of control axes	2 axes	
Control unit	mm, inch, degree, pulse	
Output type	Transistor	Differential line driver
Command speed	200 kpps	5 Mpps
Pulse output	Output signal: PULSE/SIGN mode, CW/CCW mode, phase A/B (4 multiplication), phase A/B (1 multiplication) Output terminal: Transistor 5 to 24 V DC 50 mA or less	Differential line driver equivalent to AM26C31
External I/O specifications	Input: READY/STOP/FLS/RLS/PG024/DOG/CHG terminals: 24 V DC 5 mA, PULSER A/PULSER B terminals: 5 V DC 14 mA Zero point signal PG05 terminal: 5 V DC 5 mA Output: CLEAR (deviation counter): 5 to 24 V DC 100 mA or less Circuit insulation: Photocoupler	
Power supply	24 V DC +20%, -15% 120 mA (external power supply)	24 V DC +20%, -15% 165 mA (external power supply)
Compatible CPU module	FX5UJ: Compatible from initial product FX5U, FX5UC: Ver. 1.050 or later Connection with FX5UC CPU module requires connector conversion module (FX5-CNV-IFC) or extension power supply module (FX5-C1PS-5V).	
Applicable engineering tool	FX5UJ: GX Works3 Ver. 1.060N or later FX5U, FX5UC: GX Works3 Ver. 1.035M or later	FX5U, FX5UC: GX Works3 Ver. 1.050C or later
Number of occupied I/O points	8 points (Either input or output is available for counting.)	
Number of connectable modules	FX5UJ: Up to 8 modules FX5U: Up to 16 modules FX5UC: Up to 15 modules	
External dimensions W × H × D (mm)	50 × 90 × 83	
MASS (Weight): kg	Approx. 0.2	

### ◆ Option

Connector for external devices (40-pin)

Model name	Type
A6CON1	Soldered type (straight protrusion)
A6CON2	Crimped type (straight protrusion)
A6CON4	Soldered type (both straight/inclined protrusion type)

External device connection connectors and connection cables etc. are not included with the product. Please arrange them by the customer.

## FX3U-1PG pulse output block

### ◆ Features



- 1) The module is equipped with 7 operation modes necessary for simple positioning control.
- 2) Pulse train of up to 200 kpps can be output.
- 3) Speed and target address can be changed during positioning operation to perform operation for each process.
- 4) Approximate S-curve acceleration/ deceleration is supported. Smooth high-speed operation can be performed.

### ◆ Specifications

Items	Specifications
Number of control axes	1 axis
Command speed	200 kpps (instruction unit can be selected from among 1 pps, cm/min, inch/min, and 10 deg/min)
Set pulse	-2,147,483,648 to 2,147,483,647 (Instruction unit can be selected from pulse, $\mu\text{m}$ , mdeg, $10^{-4}$ inch. In addition, magnification can be set for position data.)
Pulse output	Output signal format: Forward rotation (FP)/reverse rotation (RP) pulse or pulse (PLS)/direction (DIR) can be selected. Pulse output terminal: Transistor output 5 to 24 V DC, 20 mA or less (Photocoupler, with indication of operation by LED)
External input/output specification	Input: For STOP/DOG terminal, 24 V DC, 7 mA For zero-point signal PG0 terminal, 5 to 24 V DC, 20 mA or less Output: For each of FP (forward rotation), RP (reverse rotation), and CLR (clear) terminals, 5 to 24 V DC, 20 mA or less
Driving power	For input signal: 24 V DC, 40 mA For pulse output: 5 to 24 V DC, power consumption 35 mA or less
Control power	5 V DC, 150 mA (supplied from PLC via extension cable)
Compatible CPU module	FX5U, FX5UC: Compatible from initial product Connection with FX5U/FX5UC CPU module requires bus conversion module (FX5-CNV-BUS or FX5-CNV-BUSC).
Number of occupied input/output points	8 points (Either input or output is available for counting.)
Communication with PLC	Carried out by FROM/TO instruction via buffer memory (buffer memory can directly be specified)
Number of connectable modules	FX5U : Up to 8 modules when FX3U extension power supply modules are used Up to 6 modules when FX3U extension power supply modules are not used FX5UC : Up to 6 modules
External dimensions W × H × D (mm)	43 × 90 × 87
MASS (Weight): kg	Approx. 0.2

# Advanced Synchronous Control

FX5-40SSC-S and FX5-80SSC-S type simple motion modules are intelligent function modules compatible with SSCNET III/H, while the FX5-40SSC-G and FX5-80SSC-G type motion modules are compatible with CC-Link IE TSN.

They can be used for positioning control by servo motor via SSCNET III/H or CC-Link IE TSN-compatible servo amplifiers. For positioning control, refer to the relevant manual.

## FX5-40SSC-S type simple motion module FX5-80SSC-S type simple motion module

### ◆ Features



FX5-40SSC-S and FX5-80SSC-S are SSCNET III/H compatible modules provided with 4-/8-axis positioning function.

It can easily draw the smooth path by combining linear interpolation, 2-axis circular interpolation, and continuous path control in a point table-based program.

In "synchronous control", "parameter for synchronous control" is set and synchronous control is started for each output axis to perform control in synchronization with the input axes (servo input axis, instruction generation axis\*1, and synchronous encoder axis).

\*1: The instruction generation axis is used only for instruction generation. It can be controlled independently as an axis connected to a servo amplifier. (It is not counted as a control axis.)

### ◆ Specifications

Items		Specifications	
		FX5-40SSC-S	FX5-80SSC-S
Number of control axes		4 axes	8 axes
Operation cycle [ms]		0.888/1.777	
Interpolation function		Linear interpolation (maximum 4 axes), two-axis circular interpolation	
Control system		PTP (Point To Point) control, Trajectory control (both linear and arc), Speed control, Speed-position switching control, Position-speed switching control, Speed-torque control	
Acceleration/deceleration process		Trapezoidal acceleration/deceleration, S-curve acceleration/deceleration	
Synchronous control	Input axis	Servo input axis, synchronous encoder axis, command generation axis	
	Output axis	Cam shaft	
Cam control	Number of registration*2	Up to 64 cams	Up to 128 cams
	Cam data type	Stroke ratio data type, Coordinate data type	
	Cam auto-generation	Cam auto-generation for rotary cutter	
Control unit		mm, inch, degree, pulse	
Number of positioning data		600 data (positioning data No. 1 to 600)/axis (Can be set with MELSOFT GX Works3 or a sequence program.)	
Backup		Parameters, positioning data, and block start data can be saved on flash ROM (battery-less backup)	
Positioning control	Linear control	1-axis linear control, 2-axis linear interpolation control, 3-axis linear interpolation control, 4-axis linear interpolation control*3 (Composite speed, Reference axis speed)	
	Fixed-pitch feed control	1-axis fixed-pitch feed, 2-axis fixed-pitch feed, 3-axis fixed-pitch feed, 4-axis fixed-pitch feed*3	
	2-axis circular interpolation	Sub point designation, center point designation	
	Speed control	1-axis speed control, 2-axis speed control*3, 3-axis speed control*3, 4-axis speed control*3	
	Speed-position switching control	INC mode, ABS mode	
	Position-speed switching control	INC mode	
	Current value change	Positioning data, Start No. for a current value changing	
	NOP instruction	Provided	
	JUMP instruction	Unconditional JUMP, Conditional JUMP	
	LOOP, LEND	Provided	
High-level positioning control	Block start, Condition start, Wait start, Simultaneous start, Repeated start		
Servo amplifier connection method		SSCNET III/H	
Maximum overall cable distance [m]		400	
Maximum distance between stations [m]		100	
24 V DC external current consumption		250 mA	
Compatible CPU module		FX5UJ, FX5U, FX5UC: Compatible from initial product	
Applicable engineering tool		FX5UJ: GX Works3 Ver. 1.060N or later FX5U, FX5UC: GX Works3 Ver. 1.030G or later	
Number of occupied input/output points		8 points (Either input or output is available for counting.)	
Number of connectable modules		FX5UJ: Up to 1 module (FX5-40SSC-S and FX5-80SSC-S cannot be used simultaneously.) FX5U: Up to 16 modules FX5UC: Up to 15 modules	
External dimensions W × H × D (mm)		50 × 90 × 83	
MASS (Weight): kg		Approx. 0.3	

\*2: The number of registered cams varies depending on the memory capacity, cam resolution, and the number of coordinates.  
\*3: Only the reference axis speed is effective for the interpolation speed specification method.

## FX5-40SSC-G type motion module FX5-80SSC-G type motion module

### ◆ Features

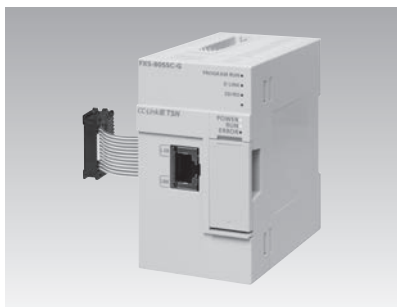

FX5-40SSC-G and FX5-80SSC-G are CC-Link IE TSN compatible modules provided with 4-/8-axis positioning function.

The functions of the CC-Link IE TSN compatible MELSERVO-J5 series of high-performance servo amplifiers can be used. Also the programs of the simple motion modules can be used.

### ◆ Specifications

Items	Specifications		
	FX5-40SSC-G	FX5-80SSC-G	
Number of control axes	4 axes	8 axes	
Operation cycle [ms]	0.500/1.000/2.000/4.000		
Interpolation function	Linear interpolation (maximum 4 axes), two-axis circular interpolation		
Control system	PTP (Point To Point) control, Trajectory control (both linear and arc), Speed control, Speed-position switching control, Position-speed switching control, Speed-torque control		
Acceleration/deceleration process	Trapezoidal acceleration/deceleration, S-curve acceleration/deceleration		
Synchronous control	Synchronous encoder input, command generation axis, cam, phase compensation, cam auto-generation		
Cam control	Number of registration*1	Up to 128 cams	
	Cam data type	Stroke ratio data type, Coordinate data type	
	Cam auto-generation	Cam auto-generation for rotary cutter	
Control unit	mm, inch, degree, pulse		
Number of positioning data	600 data (positioning data No. 1 to 600)/axis (Can be set with MELSOFT GX Works3 or a sequence program.)		
Backup	Parameters, positioning data, and block start data can be saved on flash ROM (battery-less backup)		
Positioning control	Linear control	1-axis linear control, 2-axis linear interpolation control, 3-axis linear interpolation control, 4-axis linear interpolation control*2 (Composite speed, Reference axis speed)	
	Fixed-pitch feed control	1-axis fixed-pitch feed, 2-axis fixed-pitch feed, 3-axis fixed-pitch feed, 4-axis fixed-pitch feed*2	
	2-axis circular interpolation	Sub point designation, center point designation	
	Speed control	1-axis speed control, 2-axis speed control*2, 3-axis speed control*2, 4-axis speed control*2	
	Speed-position switching control	INC mode, ABS mode	
	Position-speed switching control	INC mode	
	Current value change	Positioning data, Start No. for a current value changing	
	NOP instruction	Provided	
	JUMP instruction	Unconditional JUMP, Conditional JUMP	
	LOOP, LEND	Provided	
High-level positioning control	Block start, Condition start, Wait start, Simultaneous start, Repeated start		
Servo amplifier connection method	CC-Link IE TSN		
Maximum overall cable distance [m]	Line topology	1900 (when 20 modules are connected)	2300 (when 24 modules are connected)
	Others	Depends on the system configuration.	
Maximum distance between stations [m]	100		
24 V DC external current consumption	240 mA		
Compatible CPU module	FX5U, FX5UC: Ver. 1.230 or later		
Applicable engineering tool	FX5U, FX5UC: GX Works3 Ver. 1.072A or later		
Number of occupied input/output points	8 points (Either input or output is available for counting.)		
Number of connectable modules	FX5U, FX5UC: Up to 4 module		
External dimensions W × H × D (mm)	50 × 90 × 83		
MASS (Weight): kg	Approx. 0.3		

\*1: The number of registered cams varies depending on the memory capacity, cam resolution, and the number of coordinates.  
\*2: Only the reference axis speed is effective for the interpolation speed specification method.

memo

# Network/Communication/Information-sharing

MELSEC iQ-F Series can support not only high-speed networks like CC-Link but also other networks corresponding to control contents such as Ethernet, MODBUS, Sensor Solution, and PROFIBUS-DP. In addition, communication function to easily establish simple data link between MELSEC iQ-F Series and to RS-232C and RS-485 devices is also supported.

## ◇ CC-Link

Examples of connection are shown.

Types	Contents	Total extension length or transmission distance	Station types	Compatible CPU module			
				FX5S	FX5UJ	FX5U	FX5UC
<p><b>CC-Link IE TSN</b> (CC-Link IE TSN system by the MELSEC iQ-F series master)</p> <p>For star connections</p>	<ul style="list-style-type: none"> <li>● Outline MELSEC iQ-F series can be connected as a local station to the CC-Link IE TSN system in which the MELSEC iQ-F series is the master station.</li> <li>● Scale Max. 61 modules*1 (1 master station, 60 device stations)</li> <li>● Scope Distributed control and central management of lines, information transfer from the host network, etc.</li> </ul>	<p>Line topology: 6000 m (With 61 modules connected)</p> <p>Star topology: Depending on the system configuration</p>	<p>Master station or local station (FX5-CCLGN-MS)</p>	×	○	○	○*2
<p><b>CC-Link IE TSN</b> (CC-Link IE TSN system by the MELSEC iQ-R series master)</p> <p>For star connections</p>	<ul style="list-style-type: none"> <li>● Outline MELSEC iQ-R series can be connected as a local station to the CC-Link IE TSN system in which the MELSEC iQ-F series is the master station.</li> <li>● Scale Max. 121 modules*1 (1 master station, 120 device stations)</li> <li>● Scope Distributed control and central management of lines, information transfer from the host network, etc.</li> </ul>	<p>Line topology: 12000 m (With 121 modules connected)</p> <p>Star topology: Depending on the system configuration</p> <p>Ring topology: The FX5-CCLGN-MS is not compatible.</p>	<p>Local station (FX5-CCLGN-MS)</p>	×	○	○	○*2
<p><b>CC-Link IE Field Network</b></p> <p>For star connections</p>	<ul style="list-style-type: none"> <li>● Outline MELSEC iQ-F Series can be connected as intelligent device stations for the CC-Link IE Field Network system using MELSEC iQ-R series as master station.</li> <li>● Scale Max. 121 modules (1 master station, 120 device stations)</li> <li>● Scope Distributed control and central management of lines, information transfer from the host network, etc.</li> </ul>	<p>Line topology: 12000 m (With 121 modules connected)</p> <p>Star topology: Depending on the system configuration</p> <p>Ring topology: 12100 m (With 121 modules connected)</p>	<p>Intelligent device station (FX5-CCLIEF)</p>	×	○	○	○*2
<p><b>CC-Link IE Field Network Basic</b></p>	<ul style="list-style-type: none"> <li>● Outline CC-Link IE Field Network Basic is an FA network utilizing general-purpose Ethernet. Data communication is performed periodically (cyclic transmission) using a link device between the master station and remote station.</li> <li>● Scale FX5S/FX5UJ: Up to 8 modules FX5U/FX5UC: Up to 16 modules FX5-ENET: Up to 32 modules</li> <li>● Scope Distributed control and centralized management of lines, and exchange of information with upper network</li> </ul>	<p>Depending on the system configuration</p>	<p>Master station (FX5S/FX5UJ/FX5U/FX5UC)</p> <p>Master station (FX5-ENET)</p>	○	○	○	○

\*1: The numbers of stations shown above include the master station. When more than 1 master station (FX5-CCLGN-MS, FX5-40/80SSC-G, etc.), using the device station parameters is connected to the CPU module, the total number of the device stations must be less than the number of the device station parameter files that can be saved in the CPU module. For details about the number of device station parameter files that can be saved in the CPU module, refer to the manual.  
\*2: Connection with FX5UC CPU module requires connector conversion module (FX5-CNV-IFC) or extension power supply module (FX5-C1PS-5V).



# Network/Communication/Information-sharing

Types	Contents	Total extension length or transmission distance	Station types	Compatible CPU module			
				FX5S	FX5UJ	FX5U	FX5UC
<b>CC-Link V2 (CC-Link V2 system with MELSEC iQ-F Series master)</b> 	<ul style="list-style-type: none"> <li>● Outline This is a CC-Link V2 system where MELSEC iQ-F Series is used as master station. CC-Link V2 system can be established using just MELSEC iQ-F Series. Ver. 1.10 is also supported.</li> <li>● Scale Remote I/O station: max. 14<sup>*1*</sup> modules Intelligent device station or remote device station: max. 14<sup>*1*</sup> modules</li> <li>● Scope Distributed control and central management of lines, configuration of small-scale and high-speed network, etc.</li> </ul>	Max.1200 m	Master station (FX5-CCL-MS) Master station (FX3U-16CCL-M) Intelligent device station (FX3U-64CCL)	×	○	○	○ <sup>*4</sup>
<b>CC-Link V2 (CC-Link V2 system with MELSEC iQ-R Series master)</b> 	<ul style="list-style-type: none"> <li>● Outline MELSEC iQ-F series can be connected as an intelligent device station to the CC-Link V2 system in which the MELSEC iQ-R series etc. is the master station.</li> <li>● Scale Max. 64 modules</li> <li>● Scope Distributed control and central management of lines, information transfer from the host network, etc.</li> </ul>	Max.1200 m	Intelligent device station (FX5-CCL-MS) Intelligent device station (FX3U-64CCL)	×	○	○	○ <sup>*4</sup>

- \*1: This number is applicable when FX5-CCL-MS is used as the master station. The maximum number is 8 when FX3U-16CCL-M is used as the master station.
- \*2: Up to 6 stations when connected with the FX5UJ.
- \*3: Up to 8 stations when connected with the FX5U.
- \*4: Connection with FX5UC CPU module requires connector conversion module (FX5-CNV-IFC) or extension power supply module (FX5-C1PS-5V).
- \*5: Connection with FX5U/FX5UC CPU module requires bus conversion module (FX5-CNV-BUS or FX5-CNV-BUSC).

## ◇ Ethernet

Examples of connection are shown.

Types	Contents	Total extension length or transmission distance	Compatible CPU module			
			FX5S	FX5UJ	FX5U	FX5UC
<b>FX5S/FX5UJ/FX5U/FX5UC CPU Module</b> 	<ul style="list-style-type: none"> <li>● Outline The general-purpose Ethernet communication using the built-in Ethernet port enables the simultaneous use of some protocols.</li> <li>● Protocol type Compatible with CC-Link IE Field Network Basic, MELSOFT connection, SLMP server (3E/1E frame), socket communications, communication protocol support, FTP server, FTP client, MODBUS/TCP communication, SNMP client, Web server (HTTP), simple CPU communication function</li> <li>● Scale 1:n</li> <li>● Scope Distributed control of lines, central management, data collection, program maintenance, etc.</li> </ul>	—	○	○	○	○
<b>FX5-ENET</b> 	<ul style="list-style-type: none"> <li>● Outline The general-purpose Ethernet communication in the Ethernet module using the built-in Ethernet port enables the simultaneous use of some protocols.</li> <li>● Protocol type CC-Link IE Field Network Basic, MELSOFT connection, SLMP server (3E/1E frame), Socket communication, simple CPU communication, BACnet/IP</li> <li>● Scale 1:n</li> <li>● Scope Distributed control of lines, central management, data collection, etc.</li> </ul>	—	×	○	○	○ <sup>*</sup>
<b>FX5-ENET/IP</b> 	<ul style="list-style-type: none"> <li>● Outline The general-purpose Ethernet communication in the Ethernet module using the built-in Ethernet port enables the simultaneous use of some protocols.</li> <li>● Protocol type EtherNet/IP communication, MELSOFT connection, SLMP server (3E/1E frame), Socket communication, simple CPU communication, BACnet/IP</li> <li>● Scale 1:n</li> <li>● Scope Distributed control of lines, central management, data collection, etc.</li> </ul>	—	×	○	○	○ <sup>*</sup>

\*: Connection with FX5UC CPU module requires connector conversion module (FX5-CNV-IFC) or extension power supply module (FX5-C1PS-5V).

◇ EtherNet/IP

Examples of connection are shown.

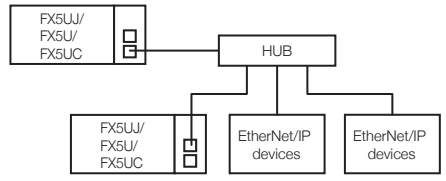
Types	Contents	Total extension length or transmission distance	Compatible CPU module			
			FX5S	FX5UJ	FX5U	FX5UC
<p><b>FX5-ENET/IP</b></p> 	<ul style="list-style-type: none"> <li>● Outline Seamless communication with the EtherNet/IP network can be realized by using the CIP communication protocol.</li> <li>● Scale 1:n</li> <li>● Scope Distributed control of lines, central management, data collection, etc.</li> </ul>	—	×	○	○	○*

\*: Connection with FX5UC CPU module requires connector conversion module (FX5-CNV-IFC) or extension power supply module (FX5-C1PS-5V).

◇ BACnet

Examples of connection are shown.

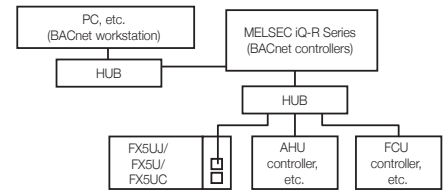
Types	Contents	Total extension length or transmission distance	Compatible CPU module			
			FX5S	FX5UJ	FX5U	FX5UC
<p><b>FX5-ENET, FX5-ENET/IP</b></p> 	<ul style="list-style-type: none"> <li>● Outline FX5-ENET(/IP) can be used as a BACnet device. Analog values and digital values are provided as inputs/outputs to the workstation and controller.</li> <li>● Scale Number of registrable input/output objects: 92 instances</li> <li>● Scope Control of air conditioning and lighting inside buildings</li> </ul>	—	×	○	○	○*

\*: Connection with FX5UC CPU module requires connector conversion module (FX5-CNV-IFC) or extension power supply module (FX5-C1PS-5V).

◇ Simple CPU communication

Examples of connection are shown.

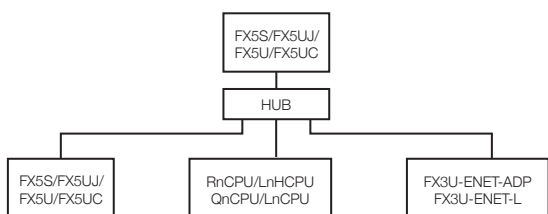
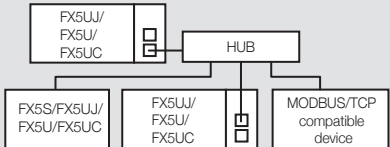
Types	Contents	Total extension length or transmission distance	Compatible CPU module			
			FX5S	FX5UJ	FX5U	FX5UC
<p><b>FX5S/FX5UJ/FX5U/FX5UC CPU Module</b></p> 	<ul style="list-style-type: none"> <li>● Outline Transmit and receive data from a specified device at a specified timing using the built-in Ethernet function.</li> <li>● Scale FX5S/FX5UJ: Max. 8 modules FX5U/FX5UC: Max. 16 modules</li> <li>● Scope Distributed control of lines, central management, data collection, etc.</li> </ul>	—	○	○	○	○
<p><b>FX5-ENET, FX5-ENET/IP</b></p> 	<ul style="list-style-type: none"> <li>● Outline This function uses the built-in Ethernet port in the Ethernet module to send/receive the specified device data at the specified timing.</li> <li>● Scale Maximum number of connected: 32 modules</li> <li>● Scope Distributed control of lines, central management, data collection, etc.</li> </ul>	—	×	○	○	○*

\*: Connection with FX5UC CPU module requires connector conversion module (FX5-CNV-IFC) or extension power supply module (FX5-C1PS-5V).

◇ MODBUS

Examples of connection are shown.

Types	Contents	Total extension length or transmission distance	Compatible CPU module			
			FX5S	FX5UJ	FX5U	FX5UC
<p><b>FX5U/FX5UC CPU Module (built-in RS-485 port), FX5-485-BD</b></p>	<ul style="list-style-type: none"> <li>● Outline The FX5 can be connected as a master or a slave to the MODBUS/RTU device via the RS-485.</li> <li>● Scale Max. 32 stations</li> <li>● Scope Configuration of small-size and high-speed network, etc.</li> </ul>	Max. 50 m	○*1	○*1	○	○*2
<p><b>FX5-232ADP, FX5-232-BD</b></p>	<ul style="list-style-type: none"> <li>● Outline The FX5 can be connected as a master or a slave to the MODBUS/RTU device via the RS-232C.</li> <li>● Scale 1:1</li> <li>● Scope Data transfer from PCs, code readers, printers, various measurement devices, etc.</li> </ul>	Max. 15 m	○	○	○	○*2
<p><b>FX5-485ADP</b></p>	<ul style="list-style-type: none"> <li>● Outline The FX5 can be connected as a master or a slave to the MODBUS/RTU device via the RS-485.</li> <li>● Scale Max. 32 stations</li> <li>● Scope Distributed control of lines, central management, etc.</li> </ul>	Max. 1200 m	○	○	○	○
<p><b>FX5S/FX5UJ/FX5U/FX5UC CPU module (with built-in Ethernet port)</b></p>	<ul style="list-style-type: none"> <li>● Outline Connections with the FX5 set as the master*3 or slave station are possible via Ethernet connection to various MODBUS/TCP devices.</li> <li>● Scale Up to 8 connections</li> <li>● Scope Distributed control of lines, central management, data collection, program maintenance, etc.</li> </ul>	—	○	○	○	○

\*1: FX5S, FX5UJ CPU module does not have a built-in RS-485 port.  
 \*2: No expansion board can be used in FX5UC CPU module.  
 \*3: The communication protocol support function is used.

◇ Sensor Solution

Examples of connection are shown.

Types	Contents	Total extension length or transmission distance	Compatible CPU module			
			FX5S	FX5UJ	FX5U	FX5UC
<p><b>FX5-ASL-M</b></p>	<ul style="list-style-type: none"> <li>● Outline This is the master module of the AnyWireASLINK system. A sensor saving wiring system of AnyWireASLINK system can be constructed.</li> <li>● Scale Max. 128 modules</li> <li>● Scope Distributed control of lines, central management of sensors, etc.</li> </ul>	Max. 200 m	×	○	○	○*1
<p><b>FX3U-128ASL-M</b></p>	<ul style="list-style-type: none"> <li>● Outline This is the master module of the AnyWireASLINK system. A sensor saving wiring system of AnyWireASLINK system can be constructed.</li> <li>● Scale Max. 128 modules</li> <li>● Scope Distributed control of lines, central management of sensors, etc.</li> </ul>	Max. 200 m	×	×	○*2	○*2

\*1: Connection with FX5UC CPU module requires connector conversion module (FX5-CNV-IFC) or extension power supply module (FX5-C1PS-5V).  
 \*2: Connection with FX5U/FX5UC CPU module requires bus conversion module (FX5-CNV-BUS or FX5-CNV-BUSC).

◇ PROFIBUS-DP

Examples of connection are shown.



Types	Contents	Total extension length or transmission distance	Station type	Compatible CPU module			
				FX5S	FX5UJ	FX5U	FX5UC
<p><b>FX5-DP-M</b></p> <p>Termination resistance</p> <p>Master station*1</p> <p>Slave stations: Up to 64 modules</p> <p>Termination resistance</p> <p>Repeater</p> <p>Slave</p>	<ul style="list-style-type: none"> <li>● Outline This PROFIBUS-DP system uses the MELSEC iQ-F Series as the master station. Using this product makes it possible to incorporate PROFIBUS-compatible slave devices used throughout Europe into the system.</li> <li>● Scale Up to 64 modules</li> <li>● Scope Distributed control and centralized management of lines, exchange of information with upper network, etc.</li> </ul>	Up to 4800 m when repeaters are used	Master station	×	○	○	○*2
<p><b>FX3U-32DP</b></p> <p>FX5-DP-M</p> <p>FX5U/FX5UC</p> <p>Master station</p> <p>Slave stations: Up to 64 modules</p> <p>Termination resistance</p> <p>Bus conversion</p> <p>FX5U/FX5UC*3</p> <p>FX3U-32DP</p> <p>FX3U-32DP</p> <p>Repeater</p> <p>Slave station or master station</p>	<ul style="list-style-type: none"> <li>● Outline Connectable as a slave station to PROFIBUS-DP systems using the MELSEC iQ-F Series as the master station.</li> <li>● Scale Up to 64 modules</li> <li>● Scope Distributed control and centralized management of lines, exchange of information with upper network, etc.</li> </ul>	Up to 4800 m when repeaters are used	Slave stations	×	×	○*3	○*3

\*1: Any station number can be set for the master station.

\*2: Connection with FX5UC CPU module requires connector conversion module (FX5-CNV-IFC) or extension power supply module (FX5-C1PS-5V).

\*3: Connection with FX5U/FX5UC CPU module requires bus conversion module (FX5-CNV-BUS or FX5-CNV-BUSC).

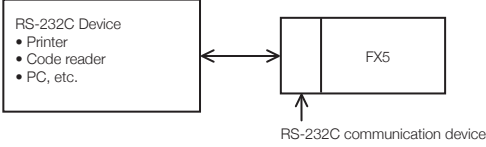
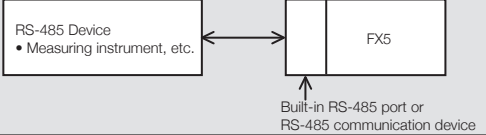
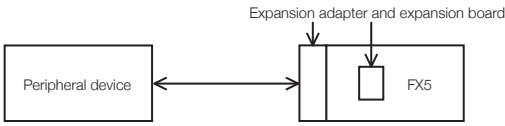
◇ **General-purpose communication/peripheral device communication** Examples of connection are shown.

Types	Contents	Distance	Compatible CPU module			
			FX5S	FX5UJ	FX5U	FX5UC
<b>RS-232C Communication</b> <b>(Communication between FX5 and RS-232C device)</b> 	<ul style="list-style-type: none"> <li>● Outline Data can be transferred from various devices with built-in RS-232C interface by non-protocol communication.</li> <li>● Scale 1:1</li> <li>● Scope Data transfer from PCs, code readers, printers, various measurement devices, etc.</li> </ul>	Max. 15 m	○	○	○	○*2
<b>RS-485 Communication</b> <b>(Communication between FX5 and RS-485 device)</b> 	<ul style="list-style-type: none"> <li>● Outline Data can be transferred from various devices with built-in RS-485 interface by non-communication protocol.</li> <li>● Scale 1:1 (1:n)</li> <li>● Scope Data transfer from PCs, code readers, printers, various measuring instrument, etc.</li> </ul>	Max. 50 m or 1200 m	○*1	○*1	○	○*2
<b>Addition of peripheral device connection port</b> <b>(Connection between FX5 and peripheral device)</b> 	<ul style="list-style-type: none"> <li>● Outline RS-232C or RS-422 port (GOT port) can be added.</li> <li>● Scale 1:1</li> <li>● Scope Simultaneous connection of two HMI, etc.</li> </ul>	[RS-422] Depends on peripheral devices to be connected.  [RS-232C] Max.15 m	○	○	○	○*2
<b>USB communication</b> 	<ul style="list-style-type: none"> <li>● Outline It can be connected with an engineering tool (GX Works3, etc.) by connecting the built-in USB port in the FX5S/FX5UJ CPU module directly with a PC.</li> <li>● Scale Maximum number of connected: 1 module</li> <li>● Scope Programming communication using engineering tools</li> </ul>	—	○	○	×	×

\*1: FX5S, FX5UJ CPU module does not have a built-in RS-485 port.  
 \*2: No expansion board can be used in FX5UC CPU module.

◇ Data link

Examples of connection are shown.

Types	Contents	Total extension length or transmission distance	Compatible CPU module			
			FX5S	FX5UJ	FX5U	FX5UC
<p><b>N:N network (n:n connection)</b></p>	<ul style="list-style-type: none"> <li>● Outline: Enabling a simple data link between FX5 and FX3.</li> <li>● Scale: Max. 8 modules</li> <li>● Scope: Distributed control and central management of lines, etc.</li> </ul>	Max. 50 m or 1200 m	○*1	○*1	○	○*2
<p><b>Parallel link</b></p>	<ul style="list-style-type: none"> <li>● Outline: With two FX5 PLCs connected, devices can be linked to each other. The data link is automatically updated between the two FX5 PLCs.</li> <li>● Scale: 1:1</li> <li>● Scope: Distributed control and centralized control of small-scale lines</li> </ul>	Max. 50 m or 1200 m	○*1	○*1	○	○*2
<p><b>MC protocol (1: n connection to external device)</b></p>	<ul style="list-style-type: none"> <li>● Outline: FX5 can be connected as a slave station by setting an external device (PC, etc.) as a master station.</li> <li>Frame 1C: Compatible to Type 1/Type 4</li> <li>Frame 3C: Compatible to Type 1/Type 4</li> <li>Frame 4C: Compatible to Type 1/Type 4/Type 5</li> <li>● Scale: 1:n (n = max. 16 modules)</li> <li>● Scope: Distributed control and central management of lines, etc.</li> </ul>	Max. 50 m or 1200 m	○*1	○*1	○	○*2
<p><b>MC protocol (1:1 connection to external device)</b></p>	<ul style="list-style-type: none"> <li>● Outline: FX5 can be connected as a slave station by setting an external device (PC, etc.) as a master station.</li> <li>Frame 1C: Compatible to Type 1/Type 4</li> <li>Frame 3C: Compatible to Type 1/Type 4</li> <li>Frame 4C: Compatible to Type 1/Type 4/Type 5</li> <li>● Scale: 1:1</li> <li>● Scope: Data collection, central management, etc.</li> </ul>	Max. 15 m	○	○	○	○*2

\*1: FX5S, FX5UJ CPU module does not have a built-in RS-485 port.  
 \*2: No expansion board can be used in FX5UC CPU module.

◇ OPC UA communication

Examples of connection are shown.

Types	Contents	Total extension length or transmission distance	Compatible CPU module			
			FX5S	FX5UJ	FX5U	FX5UC
<p><b>FX5-OPC</b></p>	<ul style="list-style-type: none"> <li>● Outline: Information on PLC input/output and internal registers is exchanged between the OPC UA server (FX5-OPC) and the OPC UA client (external application or device).</li> <li>● Scale: Maximum number of parallel sessions : 4</li> <li>● Scope: Data collection</li> </ul>	—	×	×	○	○*

\*: Connection with FX5UC CPU module requires connector conversion module (FX5-CNV-IFC) or extension power supply module (FX5-C1PS-5V).

# CC-Link IE TSN

CC-Link IE TSN

CC-Link IE TSN supports TCP/IP communications and applies it to industrial architectures through its support of TSN enabling real-time communications. FX5-CCLGN-MS is an intelligent function module intended for connecting the FX5UJ/ FX5U/FX5UC CPU module as a master or local station of the CC-Link IE TSN.

## FX5-CCLGN-MS master/local module for CC-Link IE TSN

### ◆ Features



- 1) The FX5UJ/FX5U/FX5UC CPU module can be connected as a master or local station of the CC-Link IE TSN.
- 2) Data can be transferred between the FX5UJ/FX5U/FX5UC CPU module and the FX5-CCLGN-MS via buffer memory by using the FROM/TO instruction. Data can be used in programs through replacement with internal devices (X, Y, B, W, SB, SW, etc.) via the automatic refresh function.

- \*1: The maximum number of points for all link devices may not be used simultaneously depending on the number of device stations, or the number of points and assignments of the link devices that are set in the "Network Configuration Settings" of the "Basic Settings".
- \*2: Supported by the FX5-CCLGN-MS Ver. 1.010 or later.
- \*3: The maximum number of connectable stations (61) includes the master station. When connecting multiple master stations, such as the FX5-CCLGN-M and the FX5-40/80SSC-G, which use device station parameters for the CPU module, the total number of device stations must be less than or equal to the number of device station parameter files that can be saved in the CPU module. For details about the number of device station parameter files that can be saved in the CPU module, refer to the following manual.  
→ MELSEC IQ-F FX5 User's Manual (Application)

### ◆ Specifications

Items		Specifications	
Station type		Master or local station	
Station number		<ul style="list-style-type: none"> <li>• Master station: 0</li> <li>• Local station: 1 to 120</li> </ul>	
Maximum number of link points per network	RX	16 K points (16384 points, 2 K bytes)	
	RY	16 K points (16384 points, 2 K bytes)	
	RWr	8 K points (8192 points, 16 K bytes)	
	RWw	8 K points (8192 points, 16 K bytes)	
Maximum number of link points per station*1	Master station	RX	8 K points (8192 points, 1 K bytes)
		RY	8 K points (8192 points, 1 K bytes)
		RWr	4 K points (4096 points, 8 K bytes)
		RWw	4 K points (4096 points, 8 K bytes)
	Local station	RX	16 K points (16384 points, 2 K bytes)
		RY	16 K points (16384 points, 2 K bytes)
		RWr	8 K points (8192 points, 16 K bytes)
		RWw	8 K points (8192 points, 16 K bytes)
Communication speed		1 Gbps, 100 Mbps*2	
Minimum synchronization cycle		250.00 μs	
CC-Link IE TSN Class		CC-Link IE TSN Class B device	
Maximum number of connectable stations	When used as a master station	61*3	
	When used as a local station	121	
Station-based data assurance	When used as a master station	61*3	
	When used as a local station	121	
Connection cable		For details, refer to MELSEC IQ-F FX5 User's Manual (CC-Link IE TSN).	
Overall cable distance	Line topology	12000 m (when 121 stations are connected)	
	Others	Depends on the system configuration.	
Maximum station-to-station distance		100 m	
Network number setting range		1 to 239	
Network topology		Line topology, star topology (coexistence of line topology and star topology is also possible)	
Communication method		Time sharing method	
Multicast filter		Supported	
Transient transmission capacity		1920 bytes	
Compatible CPU module		FX5UJ: Ver. 1.040 or later FX5U, FX5UC: Ver. 1.210 or later Connection with FX5UC CPU module requires connector conversion module (FX5-CNV-IFC) or extension power supply module (FX5-C1PS-5V).	
Applicable engineering tool		FX5UJ: GX Works3 Ver. 1.090U or later FX5U, FX5UC: GX Works3 Ver. 1.065T or later	
Number of occupied I/O points		8 points (Either input or output is available for counting.)	
Number of connectable modules		Only 1 module can be connected to CPU module for each station type <ul style="list-style-type: none"> <li>• Master station: 1 module</li> <li>• Local station: 1 module</li> </ul>	
Power supply		24 V DC 220 mA (external power supply)	
External dimensions W × H × D (mm)		50 × 90 × 83	
MASS (Weight): kg		Approx. 0.3	

### ◆ Network topology

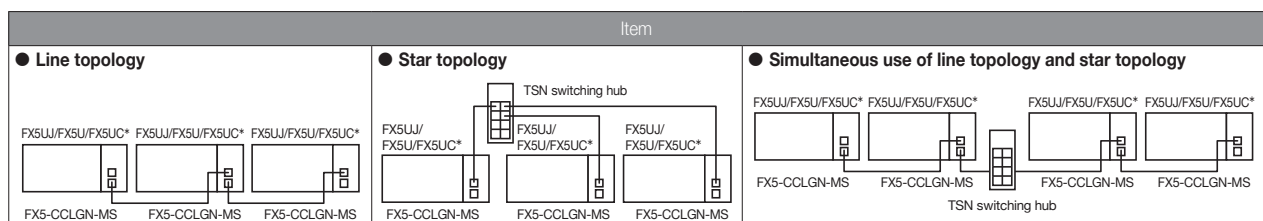

\*: Connection with FX5UC CPU module requires connector conversion module (FX5-CNV-IFC) or extension power supply module (FX5-C1PS-5V).



# CC-Link IE Field

CC-Link IE **Field**

CC-Link IE Field is a high-speed (1 Gbps), high capacity open field network using Ethernet (1000BASE-T).  
 FX5-CCLIEF is an intelligent function module to connect the FX5 CPU module as an intelligent device station to a CC-Link IE Field Network.

## FX5-CCLIEF intelligent device station for CC-Link IE Field network

### ◆ Features



MELSEC iQ-F Series modules can be connected as intelligent device stations in the CC-Link IE Field network.

### ◆ Specifications

Items		Specifications
Station type		Intelligent device station
Station number		1 to 120 (set by parameter or program)
Communication speed		1 Gbps
Network topology		Line topology, star topology (coexistence of line topology and star topology is also possible), and ring topology
Maximum station-to-station distance		100 m (conforms to ANSI/TIA/EIA-568-B (Category 5e))
Cascade connection		Max. 20 stages
Communication method		Token passing
Maximum number of link points*1	RX	384 points, 48 bytes
	RY	384 points, 48 bytes
	RWr	1024 points, 2048 bytes*2
	RWw	1024 points, 2048 bytes*2
Compatible CPU module		FX5UJ: Compatible from initial product FX5U, FX5UC: Ver. 1.030 or later Connection with FX5UC CPU module requires connector conversion module (FX5-CNV-IFC) or extension power supply module (FX5-C1PS-5V).
Applicable engineering tool		FX5UJ: GX Works3 Ver. 1.060N or later FX5U, FX5UC: GX Works3 Ver. 1.025B or later
Number of occupied I/O points		8 points (Either input or output is available for counting.)
Communication with PLC		Done by FROM/TO instruction via buffer memory (buffer memory can be directly specified)
Number of connectable modules		FX5UJ, FX5U, FX5UC: Max. 1 module
Power supply		5 V DC 10 mA (internal power supply) 24 V DC 230 mA (external power supply)
External dimensions W × H × D (mm)		50 × 90 × 103
MASS (Weight): kg		Approx. 0.3

\*1: The maximum number of link points that a master station can assign to one FX5-CCLIEF module.  
 \*2: 256 points (512 bytes) when the mode of the master station is online (High-Speed Mode).

### ◆ Network topology

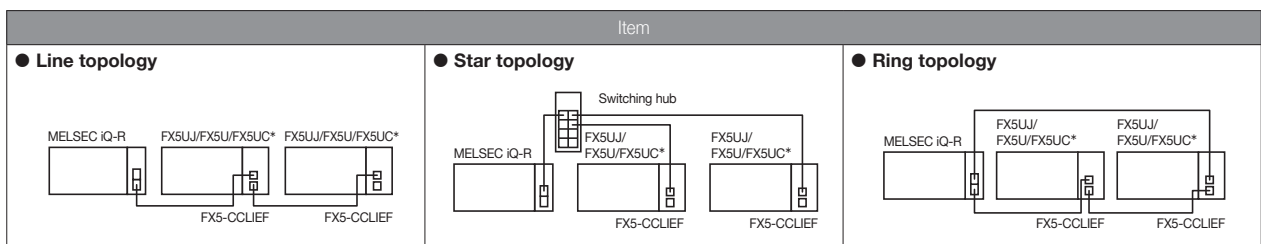

\*: Connection with FX5UC CPU module requires connector conversion module (FX5-CNV-IFC) or extension power supply module (FX5-C1PS-5V).

# CC-Link V2

CC-Link V2 is an open network enabling connection of various FA equipment.  
 A master module to set MELSEC iQ-F Series as CC-Link master, as well as an interface to connect as a CC-Link device are available.

## FX5-CCL-MS type CC-Link system master/intelligent device module

### ◆ Features



- 1) Since this module has both functions, the master station and intelligent device station, it can be used as either of them by switching with parameters.
- 2) When FX5U/FX5UC CPU module is used, parameters from the program can be set\*1.
- 3) When using the module as an intelligent device station, the transmission speed can be set to auto-tracking. Since the module tracks the transmission speed of the master station automatically, there is no setting mistake.
- 4) Supporting the other station access function, the module can use GX Works3 connected to the local station to monitor program writing and reading and devices of PLCs of other stations in the same network. This function thus eliminates the need for connecting GX Works3 to individual MELSEC iQ-F series and reduces man-hours.

### ◆ Specifications

Item		Specifications										
Compatible functions		Master station or intelligent device station										
CC-Link supported version		Ver. 2.00 and Ver. 1.10										
Transmission Speed		<ul style="list-style-type: none"> <li>• Master station: 156 kbps/625 kbps/2.5 Mbps/5 Mbps/10 Mbps</li> <li>• Intelligent device station: 156 kbps/625 kbps/2.5 Mbps/5 Mbps/10 Mbps/auto-tracking</li> </ul>										
Station number		<ul style="list-style-type: none"> <li>• Master station: 0</li> <li>• Intelligent device station: 1 to 64</li> </ul>										
Connectable station type (at the time of master station)		Remote I/O station, remote device station, intelligent device station (local station and standby master station cannot be connected)										
Maximum overall cable length		1200 m (varies depending on transmission speed)										
Maximum number of connected stations (at the time of master station)		<ul style="list-style-type: none"> <li>■ FX5UJ CPU module</li> <li>• Remote I/O stations: 6 maximum (The total number of I/O points of remote I/O station is 192 or less.)</li> <li>• The total number of intelligent device stations + remote device stations: 8 maximum (The total number of I/O points of intelligent device station + remote device station is 256 or less.)</li> <li>■ FX5U/FX5UC CPU module*2</li> <li>• Remote I/O stations: 14 maximum (The total number of I/O points of remote I/O station is 448 or less.)</li> <li>• The total number of remote device stations + intelligent device stations: 14 maximum (The total number of I/O points of intelligent device station + remote device station is 448 or less.)</li> </ul>										
Number of occupied stations (at the time of intelligent device station)		1 to 4 stations										
Maximum number of link points per system*2	CC-Link Ver. 1	<ul style="list-style-type: none"> <li>■ FX5UJ CPU module</li> <li>• Remote I/O (RX, RY): 448 points (remote I/O station: 192 points*3 + remote device stations and intelligent device stations: 256 points)</li> <li>• Remote register (RWw): 32 points</li> <li>• Remote register (RWr): 32 points</li> <li>■ FX5U/FX5UC CPU module*2</li> <li>• Remote I/O (RX, RY): 896 points (remote I/O station: 448 points*3 + remote device stations and intelligent device stations: 448 points)</li> <li>• Remote register (RWw): 56 points</li> <li>• Remote register (RWr): 56 points</li> </ul>										
	CC-Link Ver. 2	<ul style="list-style-type: none"> <li>■ FX5UJ CPU module</li> <li>• Remote I/O (RX, RY): 448 points (remote I/O station: 192 points*3 + remote device stations and intelligent device stations: 256 points)</li> <li>• Remote register (RWw): 64 points</li> <li>• Remote register (RWr): 64 points</li> <li>■ FX5U/FX5UC CPU module*2</li> <li>• Remote I/O (RX, RY): 896 points (remote I/O station: 448 points*3 + remote device stations and intelligent device stations: 448 points)</li> <li>• Remote register (RWw): 112 points</li> <li>• Remote register (RWr): 112 points</li> </ul>										
Number of link points*2	Extended cyclic setting	CC-Link Ver. 1		CC-Link Ver. 2								
				Single		Double		Quadruple		Octuple		
	Number of occupied stations		Remote I/O	Remote register	Remote I/O	Remote register	Remote I/O	Remote register	Remote I/O	Remote register	Remote I/O	Remote register
	1 station occupied		RX, RY: 32 points (16 points)*4	RWw: 4 points RWr: 4 points	RX, RY: 32 points (16 points)*4	RWw: 4 points RWr: 4 points	RX, RY: 32 points (16 points)*4	RWw: 8 points RWr: 8 points	RX, RY: 64 points (48 points)*4	RWw: 16 points RWr: 16 points	RX, RY: 128 points*5 (112 points)*4*5	RWw: 32 points*5 RWr: 32 points*5
	2 stations occupied		RX, RY: 64 points (48 points)*4	RWw: 8 points RWr: 8 points	RX, RY: 64 points (48 points)*4	RWw: 8 points RWr: 8 points	RX, RY: 96 points (80 points)*4	RWw: 16 points RWr: 16 points	RX, RY: 192 points (176 points)*4	RWw: 32 points RWr: 32 points	RX, RY: 384 points*5 (368 points)*4*5	RWw: 64 points*5 RWr: 64 points*5
	3 stations occupied		RX, RY: 96 points (80 points)*4	RWw: 12 points RWr: 12 points	RX, RY: 96 points (80 points)*4	RWw: 12 points RWr: 12 points	RX, RY: 160 points (144 points)*4	RWw: 24 points RWr: 24 points	RX, RY: 320 points*5 (304 points)*4*5	RWw: 48 points*5 RWr: 48 points*5	/	/
4 stations occupied		RX, RY: 128 points (112 points)*4	RWw: 16 points RWr: 16 points	RX, RY: 128 points (112 points)*4	RWw: 16 points RWr: 16 points	RX, RY: 224 points (208 points)*4	RWw: 32 points RWr: 32 points	RX, RY: 448 points*5 (432 points)*4*5	RWw, RWr: 64 points*5 (64 points)*4*5	/	/	
Transmission cable		CC-Link Ver. 1.10 compatible CC-Link dedicated cable										

Item	Specifications
Compatible CPU module	FX5UJ: Compatible from initial product FX5U, FX5UC: Ver. 1.050 or later Connection with FX5UC CPU module requires connector conversion module (FX5-CNV-IFC) or extension power supply module (FX5-C1PS-5V).
Applicable engineering tool	FX5UJ: GX Works3 Ver. 1.060N or later FX5U, FX5UC: GX Works3 Ver. 1.035M or later*1
Communication method	Broadcast polling method
Transmission format	HDLC compliant
Error control system	CRC ( $X^{16} + X^{12} + X^5 + 1$ )
Number of occupied I/O points	8 points (Either input or output is available for counting.)
Number of connectable modules	Only 1 module can be connected to CPU module for each station type    • Master station: 1 module*6    • Intelligent device station: 1 module*7
Power supply	24 V DC +20%, -15% 100 mA (external power supply)
Accessories	FX2NC-100MPCB type power cable (1 m, 3-wire) Ver. 1.10 compatible CC-Link dedicated cable terminating resistor (2) 110 Ω 1/2 W (color code: brown, brown, brown) Dust proof protection sheet (1)
External dimensions W x H x D (mm)	50 x 90 x 83
MASS (Weight): kg	Approx. 0.3

- \*1: To set the parameters from the buffer memory via the program in the FX5U/FX5UC CPU module, GX Works3 of Ver. 1.065T or later is required.
- \*2: Number of links with FX5U/FX5UC CPU module Ver. 1.100 or later. GX Works3 Ver. 1.047Z or later required. For details on the number of links with FX5U/FX5UC CPU module earlier than Ver. 1.100, refer to the following manual.  
→ MELSEC iQ-F FX5 User's Manual (CC-Link)
- \*3: The number of remote I/O points that can be used with the CPU module varies depending on the number of input/output points of the extension device.  
For the limit of the number of I/O points, refer to the following manual.  
→ MELSEC iQ-F FX5S/FX5UJ/FX5U/FX5UC User's Manual (Hardware)
- \*4: The numbers in parentheses are the points that can be used when the module is an intelligent device station.
- \*5: Not applicable to the FX5UJ CPU module. For details, refer to the following manual.  
→ MELSEC iQ-F FX5 User's Manual (CC-Link)
- \*6: When using the FX5-CCL-MS as the master station, it cannot be used together with the FX3U-16CCL-M.
- \*7: When using the FX5-CCL-MS as the intelligent device station, it cannot be used together with the FX3U-64CCL.

CC-Link master block FX3U-16CCL-M

◆ Features



- 1) A master module setting MELSEC iQ-F Series as master station of CC-Link.
- 2) Up to 8 remote I/O stations and up to 8 remote device stations or intelligent device stations can be connected to a master station.

◆ Specifications

Items		Specifications									
Supported functions		Master station function (No local station and standby master station functions)									
CC-Link compatible version		Ver. 2.00 compliance (Ver. 1.10 compatible at the time of setting extension cyclic to 1 time)									
Transmission speed		156 kbps/625 kbps/2.5 Mbps/5 Mbps/10 Mbps (setting by a rotary switch)									
Station No.		0 (setting by a rotary switch)									
Connectable station type		Remote I/O station, remote device station, intelligent device station (local station and standby master station cannot be connected)									
Max. cable extension length		1,200 m (varies depending on the transmission speed.)									
Max. no. of connection stations		Max. 16 stations • Remote I/O stations: 8 maximum (Each station occupies 32 I/O points of the PLC.) • Remote device stations + Intelligent device stations: 8 maximum (The total number of RX/Ry points is 256 or less.)									
Max. no of I/O points per system		[FX5U/FX5UC] The total connectable no. of (1) + (2) points below is 512 or less. (1) (No. of PLC actual I/O points) + (No. of occupied intelligent function module points) + (Occupied FX3U-16CCL-M points: 8 points) ≤ 256 (2) (32 × No. of remote I/O stations) ≤ 256									
		CC-Link Ver. 1.10				CC-Link Ver. 2.00					
		—		Single		Double		Quadruple		Octuple	
No. of link points	Extension cyclic setting	—									
	No. of occupied stations	Remote I/O	Remote register	Remote I/O	Remote register	Remote I/O	Remote register	Remote I/O	Remote register	Remote I/O	Remote register
	One station occupied	RX: 32 points RY: 32 points	RWw: 4 points RWr: 4 points	RX: 32 points RY: 32 points	RWw: 4 points RWr: 4 points	RX: 32 points RY: 32 points	RWw: 8 points RWr: 8 points	RX: 64 points RY: 64 points	RWw: 16 points RWr: 16 points	RX: 128 points RY: 128 points	RWw: 32 points RWr: 32 points
	Two stations occupied	RX: 64 points RY: 64 points	RWw: 8 points RWr: 8 points	RX: 64 points RY: 64 points	RWw: 8 points RWr: 8 points	RX: 96 points RY: 96 points	RWw: 16 points RWr: 16 points	RX: 192 points RY: 192 points	RWw: 32 points RWr: 32 points		
	Three stations occupied	RX: 96 points RY: 96 points	RWw: 12 points RWr: 12 points	RX: 96 points RY: 96 points	RWw: 12 points RWr: 12 points	RX: 160 points RY: 160 points	RWw: 24 points RWr: 24 points				
Four stations occupied	RX: 128 points RY: 128 points	RWw: 16 points RWr: 16 points	RX: 128 points RY: 128 points	RWw: 16 points RWr: 16 points	RX: 224 points RY: 224 points	RWw: 32 points RWr: 32 points					
Transmission cable		CC-Link specific cable, CC-Link specific high-performance cable, Ver. 1.10 compatible CC-Link specific cable									
RAS function		Automatic return function, device station separating function, abnormal detection by link special relay/register, device station refresh/Forced clear settings at the time of PLC CPU stop, cyclic data consistency function, and Consistency control function									
Compatible CPU module		FX5U, FX5UC: Compatible from initial product Connection with FX5U/FX5UC CPU module requires bus conversion module (FX5-CNV-BUS or FX5-CNV-BUSC).									
No. of occupied I/O points		8 points (Either input or output is available for counting.)									
Communication with PLC		Done by FROM/TO instruction via buffer memory (buffer memory can be directly specified)									
No. of connectable modules		FX5U, FX5UC: Max. 1 module*									
External power supply	Power supply voltage/ Current consumption	24 V DC +20%/ -15% ripple (p-p) within 5% (Electricity supplied from terminal block for power supply)/240 mA									
Accessories		Terminal resistors • For standard cable: 110 Ω 1/2 W (Color code, brown/brown/brown) 2 pcs. • For high-performance cable: 130 Ω 1/2 W (Color code, brown/orange/brown) 2 pcs. Special block No. label									
External dimensions W × H × D (mm)		55 × 90 × 87									
MASS (Weight): kg		Approx. 0.3									

\*: When using the FX3U-16CCL-M, it cannot be used together with the FX5-CCL-MS used as the master station.

◇ Example of system configuration with FX5U

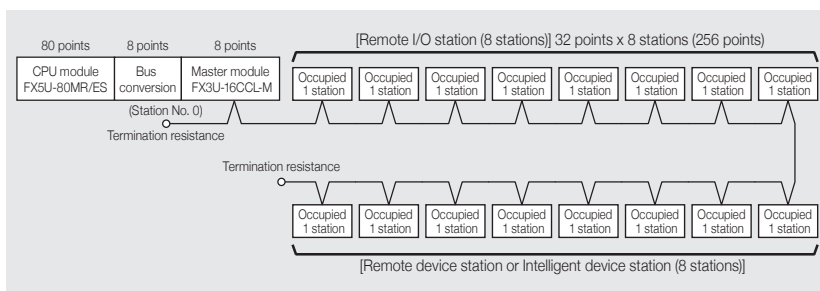

The maximum number of remote I/O stations to be connected is 8 when connecting 80-point type CPU module and FX3U-16CCL-M. The maximum number of remote I/O stations to be connected is less than 8 when the total number of points exceeds the maximum I/O points (512 points) due to the connection of I/O modules and intelligent function modules.

CC-Link interface block FX3U-64CCL

◇ Features



MELSEC iQ-F Series can be connected as intelligent device stations of CC-Link.

◇ Specifications

Items		Specifications							
Isolation method		Photocoupler							
CC-Link compatible version		Ver. 2.00 (Ver. 1.10 compliance at the time of setting extension cyclic to 1 time; Buffer memory FX2N-32CCL compatibility also selectable)							
Station types		Intelligent device station							
Station No.		1 to 64 (setting by a rotary switch)							
No. of occupied stations/ Extension cyclic setting		Occupied 1 to 4 stations, set to 1 to 8 times (setting by a rotary switch). Refer to the table below for the details of allowable range.							
Transmission speed		156 kbps/625 kbps/2.5 Mbps/5 Mbps/10 Mbps (setting by a rotary switch)							
Transmission cable		Ver. 1.10 compatible CC-Link specific cable, CC-Link specific high-performance cable							
		CC-Link Ver. 1.10				CC-Link Ver. 2.00			
No. of link points	Extension cyclic setting	Single		Double		Quadruple		Octuple	
	No. of occupied stations*1	Remote I/O	Remote register	Remote I/O	Remote register	Remote I/O	Remote register	Remote I/O	Remote register
	One station occupied	RX: 32 points RY: 32 points	RWw: 4 points RWr: 4 points	RX: 32 points RY: 32 points	RWw: 8 points RWr: 8 points	RX: 64 points RY: 64 points	RWw: 16 points RWr: 16 points	RX: 128 points RY: 128 points	RWw: 32 points RWr: 32 points
	Two stations occupied	RX: 64 points RY: 64 points	RWw: 8 points RWr: 8 points	RX: 96 points RY: 96 points	RWw: 16 points RWr: 16 points	RX: 192 points RY: 192 points	RWw: 32 points RWr: 32 points		
	Three stations occupied	RX: 96 points RY: 96 points	RWw: 12 points RWr: 12 points	RX: 160 points RY: 160 points	RWw: 24 points RWr: 24 points				
Four stations occupied	RX: 128 points RY: 128 points	RWw: 16 points RWr: 16 points	RX: 224 points RY: 224 points	RWw: 32 points RWr: 32 points					
Compatible CPU module		FX5U, FX5UC: Compatible from initial product Connection with FX5U/FX5UC CPU module requires bus conversion module (FX5-CNV-BUS or FX5-CNV-BUSC).							
No. of occupied I/O points		8 points (Either input or output is available for counting.)							
Communication with PLC		Done by FROM/TO instruction via buffer memory (buffer memory can be directly specified)							
No. of connectable modules		FX5U, FX5UC: Max. 1 module*2							
External power supply	Power supply voltage/ Current consumption	24 V DC +20%/-15% ripple (p-p) within 5% (Electricity supplied from terminal block for power supply)/220 mA							
External dimensions W x H x D (mm)		55 x 90 x 87							
MASS (Weight): kg		Approx. 0.3							

\*1: RX/Ry for a high-order word of the last station of "Remote I/O" points is occupied as a system area.  
\*2: When using the FX3U-64CCL, it cannot be used together with the FX5-CCL-MS used as the intelligent device station.

# Ethernet

Connecting FX5 to LAN (Local Area Network) via Ethernet enables various data communications and program maintenance.

## ● Outline of Functions

**Simple CPU communication**

Allows data communications between specified devices at the specified timing just by setting simple parameters from GX Works3.

**Communication by SLMP**

SLMP (SeamLess Message Protocol) can read/write the device data of PLC from the PC via the Ethernet communication.

**Remote maintenance**

Remote maintenance enables comfortable remote maintenance and monitoring. Realizes flexible maintenance using Internet regardless of where base is located!

**VPN connection construction**

VPN router: Relaying communication device by encrypting data

**VPN (Virtual Private Network)\***

This is a technology that connects networks by encrypting the communication contents. In combination with the Internet, VPN allows remotely separated networks to be accessed as if connected with each other via LAN.

\*: A VPN connection service support partner will help you support VPN system construction.

**Vision system**

An image inspection device with a high cost performance can be configured by combining FX5U and EZ-700 series into an all-in-one system.

**Main functions of Vision System**

- Presence Inspection
- Burr Inspection
- Number Counting
- Fault Test
- Positioning
- Code Reading
- Dimensional Inspection
- Inclination Inspection
- Character Recognition, etc.
- Flaw/Stain Inspection
- Foreign Matter Inspection

**Easy Builder**

- Program
- Parameter setting

**MELSOFT connection**

The Ethernet-equipped module is connected to an engineering tool (GX Works3) without using a hub but only by one Ethernet cable. This connection communicates by only specifying the connection destination without setting an IP address.

- \*1: IEEE802.3x flow control is not supported.
- \*2: For maximum segment length (length between hubs), consult the manufacturer of the hub used.
- \*3: Number of stages that can be connected when a repeater hub is used. When a switching hub is used, check the specifications of the switching hub used.
- \*4: The first device for MELSOFT connection is not included in the number of connections. (The second and the following devices are included.)
- \*5: The CC-Link IE Field Network Basic, FTP server, FTP client, SNTIP client, Web server and simple CPU communication function are not included in the number of connections.
- \*6: The ports must comply with the IEEE802.3 100BASE-TX or IEEE802.3 10BASE-T standards.
- \*7: If the first octet is 0 or 127, a parameter error (2222H) will occur. (Example: 0.0.0.0, 127.0.0.0, etc.)
- \*8: A straight cable can be used. If a personal computer or GOT and CPU module are directly connected, a cross cable can be used.

## Built-in Ethernet communication

### ◇ Features

- 1) The built-in Ethernet port can be used to connect to a PC or other device. In addition, the Ethernet communication port can handle seamless SLMP communication with the upper-level device.
- 2) Monitors and diagnoses the CPU module using a Web browser via connected network. Connect not only from a general-purpose browser on an Ethernet-connected PC but also from any general-purpose browser on a tablet or smartphone connected to an Ethernet network.

### ◇ Communication Specifications

Items	Specifications	
	FX5S/FX5UJ/FX5U/FX5UC CPU module	
Data transmission speed	100/10 Mbps	
Communication mode	Full duplex/Half duplex*1	
Interface	RJ45 connector	
Transmission method	Base band	
Maximum segment length	100 m (length between hub and node)*2	
Cascade connection	100BASE-TX	Max. 2 stages*3
	10BASE-T	Max. 4 stages*3
Supported protocol	CC-Link IE Field Network Basic, MELSOFT connection, SLMP server (3E/1E frame), socket communications, communication protocol support, FTP server, FTP client, MODBUS/TCP communication, SNTIP client, Web server (HTTP), simple CPU communication function	
No. of connections	Total of 8 connections**4*5 (Up to 8 external devices are accessible to one CPU module at a time.)	
Hub*1	A hub having 100BASE-TX or 10BASE-T port*6 can be used.	
IP address*7	Initial value: 192.168.3.250	
Circuit insulation	Pulse transformer insulation	
Cable used*8	When connecting 100BASE-TX	Ethernet cable of category 5 or higher (STP cable)
	When connecting 10BASE-T	Ethernet cable of category 3 or higher (STP cable)

## FX5-ENET Ethernet module

### ◆ Features

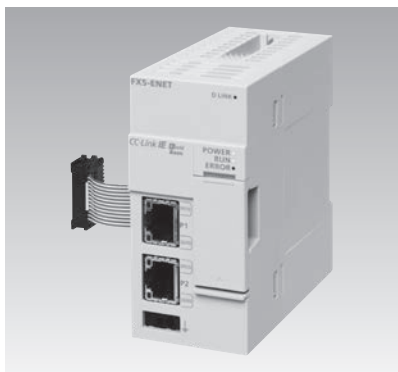

- 1) Master module for using the MELSEC iQ-F Series as a CC-Link IE Field Network Basic master station. Co-existence with general-purpose Ethernet is also possible.
- 2) Up to 32 connectable remote stations for CC-Link IE Field Network Basic, with control for up to 2048 link points for RX/Ry, and 1024 points for RWr/RWw within the same network.
- 3) Grouping of remote stations for CC-Link IE Field Network Basic with configuration of a group number, with cyclic transmission possible for each group. Grouping stations according to the remote station standard response time makes it possible to suppress the influence of differences in the standard response times of each remote station.
- 4) This module is compatible with general-purpose Ethernet communication, such as SLMP communication and socket communication.

### ◆ Specifications

Items		Specifications		
CC-Link IE Field Network Basic	Station type	Master station		
	Maximum number of connectable stations*1	32		
	Number of stations occupied by a remote station	1 to 4		
	Number of remote station groups	2		
	Maximum number of link points per network	RX	2048 points	
		Ry	2048 points	
		RWr	1024 points	
		RWw	1024 points	
	Maximum number of link points per station	Master station	RX	2048 points
			Ry	2048 points
			RWr	1024 points
			RWw	1024 points
		Remote station*2	RX	64/128/192/256 points
			Ry	64/128/192/256 points
			RWr	32/64/96/128 points
RWw			32/64/96/128 points	
UDP port number used in the cyclic transmission	61450			
UDP port number used in automatic detection of connected devices	Master station: An unused port number is assigned automatically. Remote station: 61451			
Transmission specifications	Data transfer speed	100 Mbps		
	Interface	RJ45 connector		
	Maximum station-to-station distance	100 m		
	Overall cable distance	Depends on the system configuration		
Number of cascade connections	100BASE-TX	When using a switching hub, check the number of cascaded stages with the manufacturer of the hub to be used.		
		Network topology	Line topology, star topology (Coexistence of line topology and star topology is also possible.)	
Hub*3	Hubs with 100BASE-TX ports*4 can be used.			
Connection cable*5	100BASE-TX	Ethernet cable of category 5 or higher (STP cable)		
General-purpose Ethernet communication	Transmission specifications	Data transfer speed	100/10 Mbps	
		Communication mode	Full-duplex or half-duplex*3	
		Transmission method	Base band	
		Interface	RJ45 connector	
		Maximum segment length	100 m (length between hub and node)*6	
		Number of cascade connections	100BASE-TX	2 levels maximum*7
	10BASE-T		4 levels maximum*7	
	Supported protocol*8	MELSOFT connection, SLMP server (3E/1E frame), Socket communication, simple CPU communication, BACnet/IP		
	Number of connections	Total of 32 connections*9 (Up to 32 external devices can access one FX5-ENET module at the same time.)		
	Hub*3	Hubs with 100BASE-TX or 10BASE-T ports*10 can be used.		
Connection cable*5	100BASE-TX	Ethernet cable of category 5 or higher (STP cable)		
	10BASE-T	Ethernet cable of category 3 or higher (STP/UTP cable)		
Number of ports	2*11			
Compatible CPU module	FX5UJ: Compatible from initial product FX5U, FX5UC: Ver. 1.110 or later Connection with FX5UC CPU module requires connector conversion module (FX5-CNV-IFC) or extension power supply module (FX5-C1PS-5V).			
Applicable engineering tool	FX5UJ: GX Works3 Ver. 1.060N or later*12 FX5U, FX5UC: GX Works3 Ver. 1.050C or later*12			
Number of occupied I/O points	8 points (Either input or output is available for counting.)			
Number of connectable modules	FX5UJ, FX5U, FX5UC: Up to 1 module			
Power supply	24 V DC, 110 mA (internal power supply)			
External dimensions W × H × D (mm)	40 × 90 × 83			
MASS (Weight): kg	Approx. 0.2			



# Ethernet

- \*1 : Maximum number of connected remote stations that FX5-ENET (master station) can manage. However, the maximum number of connectable modules varies depending on the number of stations occupied by a remote station.
- \*2 : Value for 1-station occupation, 2-station occupation, 3-station occupation, or 4-station occupation.
- \*3 : IEEE802.3x flow control is not supported.
- \*4 : The ports must comply with the IEEE802.3 100BASE-TX standards.
- \*5 : A straight/cross cable can be used.
- \*6 : For maximum segment length (length between hubs), consult the manufacturer of the hub used.
- \*7 : This number applies when a repeater hub is used. When using a switching hub, check the number of cascaded stages with the manufacturer of the hub to be used.
- \*8 : For a compatible version of each protocol, refer to the following manual.  
→ MELSEC iQ-F FX5-ENET User's Manual
- \*9 : The first device for MELSOFT connection is not included in the number of connections. (The second and the following devices are included.)  
The CC-Link IE field network Basic is not included in the number of connections.
- \*10: The ports must comply with the IEEE802.3 100BASE-TX or IEEE802.3 10BASE-T standards.
- \*11: Because the IP address is shared by two ports, only one address can be set.
- \*12: To use the MELSOFT connection, SLMP communication, simple CPU communication, and BACnet/IP, GX Works3 of Ver. 1.075D or later is required.



# EtherNet/IP

EtherNet/IP is a network using Ethernet.

Standard Ethernet is used, so general-purpose Ethernet can be used simultaneously.

## FX5-ENET/IP Ethernet module

### ◆ Features



- 1) MELSEC iQ-F series module can be connected to the EtherNet/IP network. Coexistence with general-purpose Ethernet is also possible.
- 2) The EtherNet/IP communication parameters can be set with the dedicated setting tool (EtherNet/IP Configuration Tool for FX5-ENET/IP). The tool can be used not only to set the EtherNet/IP communication conditions, but also to detect EtherNet/IP devices on the network and set the EtherNet/IP communication conditions online.
- 3) Up to 32 modules can be connected to each of EtherNet/IP communication and general Ethernet communication networks.
- 4) This module is compatible with general-purpose Ethernet communication, such as SLMP communication and socket communication.

### ◆ Specifications

Items		Specifications	
EtherNet/IP communications	Class 1 communications	Communication format	Standard EtherNet/IP
		Number of connections	32
		Communication data size	1444 bytes (per connection)
		Connection type	Point-to-point, multicast
		RPI (communication cycle)	2 to 60000 ms
	Class 3 communications*1	Communication format	Standard EtherNet/IP
		Number of connections	32*2
		Connection type	Point-to-point
	UCMM communications	Communication format	Standard EtherNet/IP
		Number of connections (number of simultaneous executions)	32*2
		Communication data size	1414 bytes*3
	Transmission specifications	Connection type	Point-to-point
		Data transmission speed	100 Mbps
		Communication mode	Full-duplex
		Transmission method	Base band
		Interface	RJ45 connector
IP version		IPv4 is supported.	
Maximum segment length		100 m (length between hub and node)*4	
Number of cascade connections	100BASE-TX	2 levels maximum*5	
Network topology	Star topology, line topology		
Hub*6	Hubs with 100BASE-TX ports*7 can be used.		
Connection cable*8	100BASE-TX	Ethernet cable of category 5 or higher (STP cable)	
General-purpose Ethernet communication	Transmission specifications	Data transfer speed	100/10 Mbps
		Communication mode	Full-duplex or half-duplex*6
		Transmission method	Base band
		Interface	RJ45 connector
		Maximum segment length	100 m (length between hub and node)*4
	Number of cascade connections	100BASE-TX	2 levels maximum*5
		10BASE-T	4 levels maximum*5
	Protocol type*9	MELSOFT connection, SLMP server (3E/1E frame), socket communication, simple CPU communication, BACnet/IP	
	Number of connections	Total of 32 connections*10 (Up to 32 external devices can access one FX5-ENET/IP module at the same time.)	
	Hub*6	Hubs with 100BASE-TX or 10BASE-T ports*11 can be used.	
Connection cable*8	100BASE-TX	Ethernet cable of category 5 or higher (STP cable)	
	10BASE-T	Ethernet cable of category 3 or higher (STP/UTP cable)	

Items	Specifications
Number of ports	2*12
Compatible CPU module	FX5UJ: Compatible from initial product FX5U, FX5UC: Ver. 1.110 or later Connection with FX5UC CPU module requires connector conversion module (FX5-CNV-IFC) or extension power supply module (FX5-C1PS-5V).
Applicable engineering tool	FX5UJ: GX Works3 Ver. 1.060N or later*13 FX5U, FX5UC: GX Works3 Ver. 1.050C or later*13 EtherNet/IP Configuration Tool for FX5-ENET/IP: Ver. 1.00A or later
Number of occupied I/O points	8 points (Either input or output is available for counting.)
Number of connectable modules	FX5UJ, FX5U, FX5UC: Up to 1 module
Power supply	24 V DC, 110 mA (internal power supply)
External dimensions W x H x D (mm)	40 x 90 x 83
MASS (Weight): kg	Approx. 0.2

- \*1 : Class 3 communication supports the server functions.
- \*2 : The total number of connections for Class 3 communications and UCMM communications is 32.
- \*3 : This size is the maximum size which can be specified to 'Data length' of Class 1 communication input data area of the request command during the client operation.  
During the sever operation, since the FX5-ENET/IP automatically responds according to the request command received from the client, the maximum size is not prescribed.
- \*4 : For maximum segment length (length between hubs), consult the manufacturer of the hub used.
- \*5 : This number applies when a repeater hub is used. When using a switching hub, check the number of cascaded stages with the manufacturer of the hub to be used.
- \*6 : IEEE802.3x flow control is not supported.
- \*7 : The ports must comply with the IEEE802.3 100BASE-TX standards.
- \*8 : A straight/cross cable can be used.
- \*9 : For a compatible version of each protocol, refer to the following manual.  
→ MELSEC iQ-F FX5-ENET/IP User's Manual
- \*10: The first device for MELSOFT connection is not included in the number of connections. (The second and the following devices are included.)  
The CC-Link IE field network Basic is not included in the number of connections.
- \*11: The ports must comply with the IEEE802.3 100BASE-TX or IEEE802.3 10BASE-T standards.
- \*12: Since the IP address is shared by two ports, only one address can be set.
- \*13: To use the MELSOFT connection, SLMP communication, simple CPU communication, and BACnet/IP, GX Works3 of Ver. 1.075D or later is required.

memo

# MODBUS

FX5 can be connected to various MODBUS communication devices as master station or slave station of the MODBUS communication.

## MODBUS RTU communication

### ◆ Features

- 1) Connection to 32 slave stations for RS-485 communication and one slave station for RS-232C communication is possible with a single master station.
- 2) Master function and slave functions are supported, and the master and slave can be used simultaneously by a single FX5. (However, only 1 channel can be used for the master station.)
- 3) Up to 4 channels\*1 can be used for MODBUS serial communication function by one CPU module.

### ◆ System configuration example

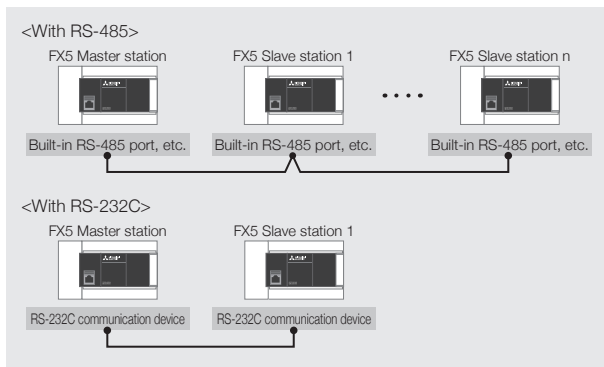

### ◆ Specifications

Item	Specifications	
	FX5U/FX5UC CPU module Built-in RS-485 port FX5-485-BD FX5-485ADP	FX5-232-BD FX5-232ADP
Number of connected modules	Up to 4 channels*1 (only 1 channel for the master)	
Communication Specifications	Communication interface	RS-485 / RS-232C
	Baud rate	300/600/1200/2400/4800/9600/19200/ 38400/57600/115200 bps
	Data length	8 bits
	Parity bit	None, odd or even
	Stop bit	1 bit/2 bits
Transmission distance*2	1200 m or less when configured with FX5-485ADP only	15 m or less
	50 m or less when configured other than the above	
Communication protocol	RTU	
Master function	Number of connectable slaves*3	32 stations / 1 station
	Number of functions	8 (without diagnostic function)
	Number of simultaneous transmission messages	1 message
	Maximum number of writes	123 words or 1968 coils
Slave function	Maximum number of reads	125 words or 2000 coils
	Number of functions	8 (without diagnostic function)
	Number of messages that can be received simultaneously	1 message
Station number	1 to 247	

\*1: Available by either master or slave.  
Maximum number of channels differs depending on the CPU module. For details, refer to the following manual.  
→ MELSEC iQ-F FX5 User's Manual (MODBUS Communication)

\*2: The transmission distance varies depending on the type of communications equipment.

\*3: The number of slaves varies depending on the type of communications equipment.

## MODBUS/TCP communication

### ◆ Features

- 1) Communication is possible, via Ethernet connection, with various MODBUS/TCP master devices connected to the FX5 set as the slave station.
- 2) Master function and slave functions are supported, and the master and slave can be used simultaneously by a single FX5.
- 3) Up to 8 connections can be used for MODBUS/TCP communication function by one CPU module.
- 4) The master uses a predefined protocol support function and controls the slave.

### ◆ System configuration example

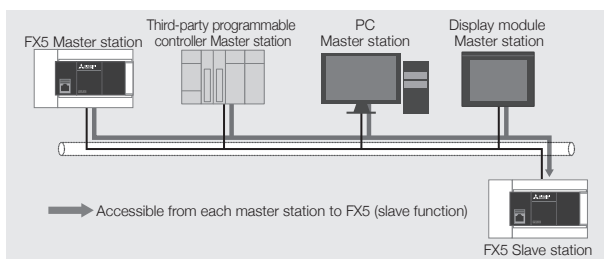

### ◆ Specifications

For communication specification other than the followings, refer to the MELSEC iQ-F FX5 User's Manual (Ethernet Communication).

Items	Specifications
Supported protocol	MODBUS/TCP (Binary only supported)
Number of connections	Total of 8 connections*1 (Up to 8 external devices can access one CPU module at the same time.)
Slave function	Number of functions
	Port station No.

\*1: The number of available connections decreases when the other Ethernet communication function is used. However, the first MELSOFT connection, CC-Link IE Field Network Basic, FTP server, FTP client, SNMP client, and Web server are not included in the number of connections (The second and subsequent MELSOFT connections are included). For details on the Ethernet communication function, refer to the following manual.  
→ MELSEC iQ-F FX5 User's Manual (Ethernet Communication)

\*2: The port station No. can be changed by the communication setting.

# Sensor Solution

Sensor wire-saving system of AnyWireASLINK is easily configurable.

## FX5-ASL-M type AnyWireASLINK system master module

### ◇ Features



- 1) The AnyWireASLINK system can centrally monitor the status of sensors from the PLC and perform disconnection/short-circuit detection, sensor sensitivity setting, status monitoring, etc. It has no restriction on minimum distance between terminals. Any wiring method, such as T-branch, multi-drop, and star, can be used, and it can be flexibly branched and connected.
- 2) Since the status of the sensor can be monitored from the PLC, it is possible to predict the occurrence of troubles such as a decrease in the amount of light received by the sensor and prevent the production line from stopping in advance.
- 3) ID (address) can be changed from the buffer memory for one remote module without using the address writer. A remote ID can be changed even from a remote location.\*

\*: For the remote modules compatible with the remote address change function, contact Anywire Corporation.

### ◇ Safety precautions

FX5-ASL-M is jointly developed and manufactured with Anywire Corporation. Note that the warranty for this product differs from the ones for other PLC products.

For details of warranty and specifications, refer to the manual.

### ◇ Specifications

Item	Specifications
Transmission clock	27.0 kHz
Maximum transmission distance (total extension distance)	200 m*1
Transmission system	DC power supply superimposed total frame/cyclic system
Connection type	Bus type (multi-drop method, T-branch method, tree branch method)
Transmission protocol	Dedicated protocol (AnyWireASLINK)
Error control	Checksum, double check method
Number of connected I/O points	<ul style="list-style-type: none"> <li>• FX5UJ: Up to 216 points*2 (192 input points maximum/192 output points maximum)</li> <li>• FX5U, FX5UC: Up to 448 points*2*3 (256 input points maximum/256 output points maximum)</li> </ul>
Number of connected modules	Up to 128 modules (the number varies depending on the current consumption of each remote module)
Maximum number of I/O points per system	Number of remote module input points + number of remote module output points ≤ 384 points
External interface	7-piece spring clamp terminal block push-in type
RAS function	<ul style="list-style-type: none"> <li>• Transmission line disconnection position detection function</li> <li>• Transmission line short-circuit detection function</li> <li>• Transmission power drop detection function</li> </ul>
Transmission line (DP, DN)	UL compatible general-purpose 2-wire cable (VCTF, VCT 1.25 mm <sup>2</sup> , 0.75 mm <sup>2</sup> , temperature rating 70°C or higher) UL compatible general-purpose cable (1.25 mm <sup>2</sup> , 0.75 mm <sup>2</sup> , temperature rating 70°C or higher) Dedicated flat cable (1.25 mm <sup>2</sup> , 0.75 mm <sup>2</sup> , temperature rating 90°C)
Power cable (24 V, 0 V)	UL compatible general-purpose 2-wire cable (VCTF, VCT 0.75 to 2.0 mm <sup>2</sup> , temperature rating 70°C or higher) UL compatible general-purpose power cable (0.75 to 2.0 mm <sup>2</sup> , temperature rating 70°C or higher) Dedicated flat cable (1.25 mm <sup>2</sup> , 0.75 mm <sup>2</sup> , temperature rating 90°C)
Memory	Built-in EEPROM (Number of times of overwrite : 100000 times)
Compatible CPU module	FX5UJ: Compatible from initial product FX5U, FX5UC: Ver. 1.050 or later Connection with FX5UC CPU module requires connector conversion module (FX5-CNV-IFC) or extension power supply module (FX5-C1PS-5V).
Applicable engineering tool	FX5UJ: GX Works3 Ver. 1.060N or later FX5U, FX5UC: GX Works3 Ver. 1.035M or later
Power supply	5 V DC, 200 mA (internal power supply) 24 V DC -10%, +15% 100 mA (external power supply)
Number of occupied I/O points	8 points (Either input or output is available for counting.)
Number of connectable modules	FX5UJ, FX5U, FX5UC: Max. 1 module*4
External dimensions W × H × D (mm)	40 × 90 × 97.3
MASS (Weight): kg	Approx. 0.2

\* 1: For the remote module in which the transmission line (DP, DN) and module body are integrated, the length of the transmission line (DP, DN) is also included in the total extension.  
When laying a 4-wire (DP, DN, 24 V, 0 V) line for fifty meters or more, insert a power line noise filter between the power supply and the line.

For details, refer to the manual of ASLINK filter (ANF-01) made by Anywire Corporation.

\* 2: The number of remote I/O points that can be used CPU module varies depending on the number of input/output points of the extension device.

For the limit of the number of I/O points, refer to the following manual.  
→ MELSEC iQ-F FX5S/FX5UJ/FX5U/FX5UC User's Manual (Hardware)

\* 3: Supported by FX5U/FX5UC CPU module Ver. 1.100 or later and by GX Works3 Ver. 1.047Z or later.

\* 4: Use together with the FX3U-128ASL-M is not possible.

## FX3U-128ASL-M type AnyWireASLINK system master block

### ◇ Characteristics



- 1) A master module enables MELSEC iQ-F series to be connected to the AnyWireASLINK sensor wire-saving system of Anywire Corporation.
- 2) FX3U-128ASL-M type AnyWireASLINK system master module has a proprietary AnyWire transmission system including a power supply (equivalent to 24 V DC, MAX. 2 A) as a transmission signal, and thus realizes save wiring up to 200 m with a 4-core or 2-core cable.
- 3) When using ASLINKAMP or ASLINKSENSOR, settings can be changed by a ladder program, engineering tool or GOT. Set-up changes can be done remotely.

### ◇ Safety Precautions

FX3U-128ASL-M is jointly developed/ manufactured with Anywire Corporation. Guarantee details are different from other PLC products. Refer to manuals for guarantees/ specifications.

### ◇ Specifications

Items	Specifications
Transmission clock	27.0 kHz
Max. transmission distance (total extension length)	200 m
Transmission method	DC power supply superimposing total frame/cyclic method
Connection configuration	Bus type (Multi-drop method, T-branch method, tree branch method)
Transmission protocol	Dedicated protocol (AnyWireASLINK)
Error control	Double verification method, checksum
No. of connection I/O points	Max. 128 points
No. of connection modules	Max. 128 modules (variable depending on current consumption)
Max. no of I/O points per system	No. of input points of remote module + No. of output points of remote module ≤ 128 points
RAS function	<ul style="list-style-type: none"> <li>• Transmission line disconnection position detection function</li> <li>• Transmission line short-circuit detection function</li> <li>• Transmission power drop detection function</li> </ul>
AnyWireASLINK transmission line	UL supported general-use 2-line cable (VCTF, VCT 1.25 mm <sup>2</sup> , 0.75 mm <sup>2</sup> , rated temperature: 70°C or higher) UL supported general-use electric wire (1.25 mm <sup>2</sup> , 0.75 mm <sup>2</sup> , rated temperature: 70°C or higher), dedicated flat cable (1.25 mm <sup>2</sup> , 0.75 mm <sup>2</sup> , rated temperature: 90°C)
24 V DC power supply line	UL supported general-use 2-line cable (VCTF, VCT 0.75 to 2.0 mm <sup>2</sup> , rated temperature: 70°C or higher) UL supported general-use electric wire (0.75 to 2.0 mm <sup>2</sup> , rated temperature: 70°C or higher), dedicated flat cable (1.25 mm <sup>2</sup> , 0.75 mm <sup>2</sup> , rated temperature: 90°C)
Compatible CPU module	FX5U, FX5UC: Compatible from initial product Connection with FX5U/FX5UC CPU module requires bus conversion module (FX5-CNV-BUS or FX5-CNV-BUSC).
Power supply	5 V DC, 130 mA (internal power supply) 24 V DC -10% +15% 100 mA (AnyWireASLINK communication external power supply)
No. of occupied I/O points	8 points (Either input or output is available for counting.)
Communication with PLC	Done by FROM/TO instruction via buffer memory (buffer memory can be directly specified)
No. of connectable modules	FX5U, FX5UC: Max. 1 module*
External dimensions W x H x D (mm)	43 x 90 x 95.5
MASS (Weight): kg	Approx. 0.2

\*: Use together with the FX5-ASL-M is not possible.

Your requests for reduced wiring, detecting of disconnection/short circuit, setting of sensor sensitivity, and status monitoring can be satisfied by MELSEC iQ-F.

Powered by **Anywire**

► Example of system configuration (AnyWireASLINK)

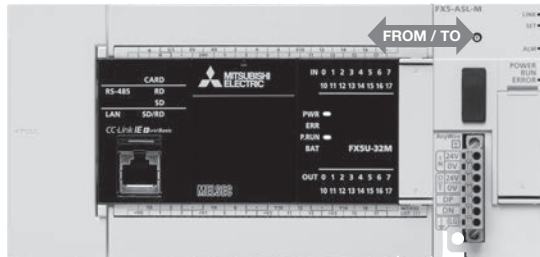

FX5-ASL-M

AnyWireASLINK sensor can be connected.

Detection of short circuit and disconnection, setting of sensor sensitivity, address automatic recognition

Total extension length of 200 m\*1, Max. 448 points\*2\*3\*4 and Max. 128 modules\*5 connectable

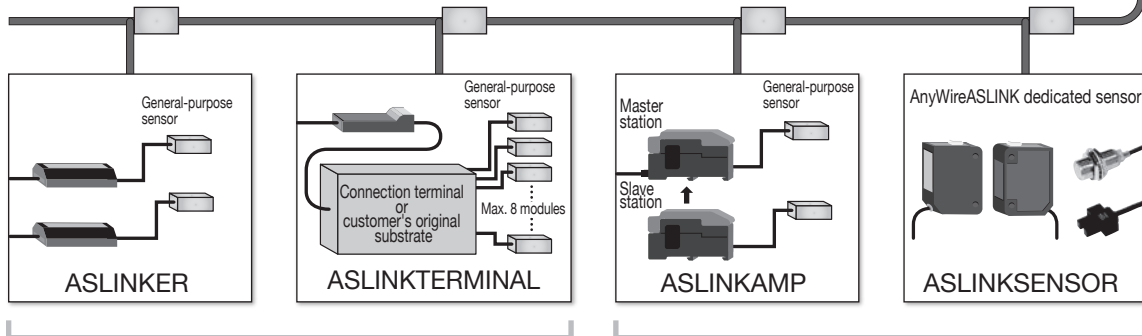

Sensor disconnection is detectable

Disconnection and short-circuit of sensors are detectable  
Setting of sensor sensitivity or status monitoring are possible

AnyWireASLINK

Max. no. of I/O: 2 points

■ ASLINKER

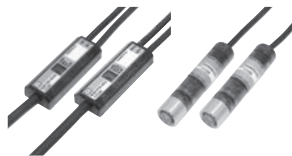

Cable lamp

Connector type

Max. no. of I/O: 8 points

■ ASLINKTERMINAL



8-point input terminal

8-point output terminal

General-purpose sensor head connection

■ ASLINKAMP



Max. 16 modules can be added.

Directly connected sensors

■ ASLINKSENSOR



Optical sensor

Proximity sensor

Photo interrupter

\* 1: Total extension distance including the portion of branch line.  
 \* 2: The number of remote I/O points that can be used with the CPU module varies depending on the number of input/output points of the extension device. For the limit of the number of I/O points, refer to the following manual.  
 → MELSEC iQ-F FX5S/FX5UJ/FX5U/FX5UC User's Manual (Hardware)  
 \* 3: Supported by FX5U/FX5UC CPU module Ver. 1.100 or later and by GX Works3 Ver. 1.047Z or later.  
 \* 4: FX5UJ CPU module: Up to 216 points.  
 \* 5: Subject to change based upon current consumption of each remote module.

# PROFIBUS-DP

PROFIBUS is an industrial fieldbus developed and maintained by PROFIBUS & PROFINET International (PI). This protocol enables high-speed data transmission between field devices such as a remote I/O module or drive and a controller.

## FX5-DP-M type PROFIBUS-DP master module

### ◆ Features



- 1) This master module is necessary for using the MELSEC iQ-F Series as a PROFIBUS-DP master station. Using this product makes it possible to incorporate compatible slave devices into the system.
- 2) Using the buffer memory makes it possible to obtain communications error information or extended communications error information generated by a slave station during I/O data transmission.
- 3) Settings can be configured with the following software:
  - GX Works3 (FX5UJ: Ver. 1.060N or later, FX5U/FX5UC: Ver. 1.050C or later)
  - PROFIBUS Configuration Tool (FX5UJ: Ver. 1.03D or later, FX5U/FX5UC: Ver. 1.02C or later)

### ◆ Specifications

Items		Specifications
PROFIBUS-DP station type		Class 1 master station
Electrical standard and characteristics		Compliant with EIA-RS485
Medium		Shielded twisted pair cable
Network configuration		Bus topology (or tree topology when repeaters are used)
Data link method		Between DP-Masters: Token passing Between DP-Master and DP-Slave: Polling
Encoding method		NRZ
Transmission speed*		9.6 kbps, 19.2 kbps, 93.75 kbps, 187.5 kbps, 500 kbps, 1.5 Mbps, 3 Mbps, 6 Mbps, 12 Mbps
Transmission distance		Differs depending on transmission speed
Maximum number of repeaters (Between DP-Master and DP-Slave)		3 repeaters
Number of connectable modules (per segment)		32 per segment (including repeaters)
Maximum number of DP-Slaves		64 modules
Number of connectable nodes (number of repeaters)		32, 62 (1), 92 (2), 122 (3), 126 (4)
Transmittable data	Input data	Max. of 2048 bytes (Max. of 244 bytes per DP-Slave)
	Output data	Max. of 2048 bytes (Max. of 244 bytes per DP-Slave)
Compatible CPU module		FX5UJ: Compatible from initial product FX5U, FX5UC: Ver. 1.110 or later Connection with FX5UC CPU module requires connector conversion module (FX5-CNV-IFC) or extension power supply module (FX5-C1PS-5V).
Applicable engineering tool		FX5UJ: GX Works3 Ver. 1.060N or later PROFIBUS Configuration Tool: Ver. 1.03D or later FX5U, FX5UC: GX Works3 Ver. 1.050C or later PROFIBUS Configuration Tool: Ver. 1.02C or later
Number of occupied I/O points		8 points (Either input or output is available for counting.)
Number of connectable modules		FX5UJ, FX5U, FX5UC: Up to 1 module
Power supply		24 V DC, 150 mA (internal power supply)
External dimensions W × H × D (mm)		40 × 90 × 85.3
MASS (Weight): kg		Approx. 0.2

\*: Transmission speed accuracy is within ±0.2% (compliant with IEC61158-2).

## FX3U-32DP PROFIBUS-DP interface block

### ◆ Features



Connectable as a MELSEC iQ-F Series slave station in PROFIBUS-DP systems.

### ◆ Specifications

Items		Specifications					
PROFIBUS-DP station type		PROFIBUS-DP slave station					
Transmission speed		9.6 kbps, 19.2 kbps, 45.45 kbps, 93.75 kbps, 187.5 kbps, 500 kbps, 1.5 Mbps, 3 Mbps, 6 Mbps, 12 Mbps					
Transmission distance/segment	Transmission speed	9.6 kbps, 19.2 kbps, 45.45 kbps, 93.75 kbps	187.5 kbps	500 kbps	1.5 Mbps	3 Mbps, 6 Mbps, 12 Mbps	
		No repeaters	1,200 m	1,000 m	400 m	200 m	100 m
		1 repeater	2,400 m	2,000 m	800 m	400 m	200 m
		2 repeaters	3,600 m	3,000 m	1,200 m	600 m	300 m
		3 repeaters	4,800 m	4,000 m	1,600 m	800 m	400 m
Transmittable data		Up to 144 bytes Default: 32 bytes (cyclic input / cyclic output)					
PROFIBUS module ID		F332h					
Global control		Supports SYNC, UNSYNC, FREEZE, and UNFREEZE modes					
Compatible CPU module		FX5U, FX5UC: Compatible from initial product Connection with FX5U/FX5UC CPU module requires bus conversion module (FX5-CNV-BUS or FX5-CNV-BUSC).					
Number of occupied I/O points		8 points (Either input or output is available for counting.)					
Number of connectable modules		FX5U: Up to 8 modules*, FX5UC: Up to 6 modules					
Power supply		24 V DC, 145 mA (internal power supply)					
External dimensions W × H × D (mm)		43 × 90 × 89					
MASS (Weight): kg		Approx. 0.2					

\*: When using FX3U-1PSU-5V. Up to 6 modules when not using FX3U-1PSU-5V.



# General-purpose Communication Devices

Various communication functions can be added easily using an expansion board or expansion adapter. Communications with data link or external serial interface device can be realized easily by adding an expansion board.

## Expansion board (for communication)

### ◆ Features

- 1) Communication expansion board can be added to FX5S/FX5UJ/FX5U CPU module.
- 2) Communication function can be added inexpensively.

Refer to the following items for usage method of expansion board.

- "N:N network" • "Parallel link" • "MC protocol"
- "Non-protocol communication"
- "Connection to peripheral device"
- "Inverter communication function"



### ◆ Specifications

Model/Characteristics	Items	Specifications
<b>FX5-232-BD</b> RS-232C communication expansion board 	Transmission standard	Conforming to RS-232C standard
	Max. transmission distance	15 m
	External device connection method	9-pin D-sub (male)
	Insulation	Non-isolation (between communication line and CPU)
	Communication method	Half-duplex bidirectional/Full-duplex bidirectional*1
	Protocol type	MELSOFT connection, MC protocol (1C/3C/4C frame), non-protocol communication, MODBUS RTU communication, predefined protocol support
	Communication speed	300/600/1200/2400/4800/9600/19200/38400/57600/115200 (bps)*1
	Terminal resistors	—
	Power supply	5 V DC, 20 mA (internal power supply)*2
	Compatible CPU module	FX5S, FX5UJ, FX5U CPU module
	No. of occupied I/O points	0 points (no occupied points)
	External dimensions W × H × D (mm)	38 × 51.4 × 18.2
MASS (Weight): kg	Approx. 0.02	
<b>FX5-485-BD</b> RS-485 communication expansion board 	Transmission standard	Conforming to RS-485 and RS-422 standards
	Max. transmission distance	50 m
	External device connection method	European-type terminal block
	Insulation	Non-isolation (between communication line and CPU)
	Communication method	Half-duplex bidirectional/Full-duplex bidirectional*1
	Protocol type	MELSOFT connection, MC protocol (1C/3C/4C frame), non-protocol communication, MODBUS RTU communication, inverter communication, N:N network, parallel link, predefined protocol support
	Communication speed	300/600/1200/2400/4800/9600/19200/38400/57600/115200 (bps)*1
	Terminal resistors	Built in (OPEN/110 Ω/330 Ω)
	Power supply	5 V DC, 20 mA (internal power supply)*2
	Compatible CPU module	FX5S, FX5UJ, FX5U CPU module
	No. of occupied I/O points	0 points (no occupied points)
	External dimensions W × H × D (mm)	38 × 51.4 × 30.5
MASS (Weight): kg	Approx. 0.02	
<b>FX5-422-BD-GOT</b> RS-422 communication expansion board (GOT connection) 	Transmission standard	Conforming to RS-422 standard
	Max. transmission distance	As per GOT specifications
	External device connection method	8-pin MINI-DIN (female)
	Insulation	Non-isolation (between communication line and CPU)
	Communication method	Half-duplex bidirectional
	Communication speed	9600/19200/38400/57600/115200 (bps)
	Terminal resistors	—
	Power supply	5 V DC, 20 mA (internal power supply)*2*3
	Compatible CPU module	FX5S, FX5UJ, FX5U CPU module
	No. of occupied I/O points	0 points (no occupied points)
	External dimensions W × H × D (mm)	38 × 51.4 × 15.4
	MASS (Weight): kg	Approx. 0.02

\*1: The communication method and communication speed vary depending upon the communication type.

\*2: Current consumption calculation is not required for the FX5S/FX5UJ CPU module.

\*3: When the GOT 5V type is connected with this product, the power consumption increases. For the current consumption, refer to the manual of the model to be connected.

## FX5-232ADP communication adapter is an expansion adapter for RS-232C communication

### ◆ Features



Insulation type RS-232C communication adapter  
Refer to the "MC protocol", "Non-protocol communication", "Connection to peripheral device" for more details of functions.

### ◆ Specifications

Items	Specifications
Transmission standard	Conforming to RS-232C standard
Max. transmission distance	15 m
Insulation	Photocoupler (between communication line and CPU)
External device connection method: connector	9-pin D-sub (male)
Communication method	Half-duplex bidirectional/Full-duplex bidirectional
Protocol type	MELSOFT connection, MC protocol (1C/3C/4C frame), non-protocol communication, MODBUS RTU communication, predefined protocol support
Communication speed	300/600/1200/2400/4800/9600/19200/38400/57600/115200 (bps)*1
No. of occupied I/O points	0 points (no occupied points)
Current consumption (internal supply)	5 V DC 30 mA/24 V DC 30 mA
Compatible CPU module	FX5S, FX5UJ, FX5U, FX5UC: Compatible from initial product
Number of connectable modules	FX5S, FX5UJ, FX5U, FX5UC: Up to 2 communication adapters are provided on the left side of the CPU module.*2
External dimensions W × H × D (mm)	17.6 × 106 × 82.8
MASS (Weight): kg	Approx. 0.08

\*1: The communication method and communication speed vary depending upon the communication type.

\*2: For FX5S, FX5UJ CPU module, when the expansion board is connected, up to one communication adapter can be connected.

## FX5-485ADP communication adapter is an expansion adapter for RS-485 communication

### ◆ Features

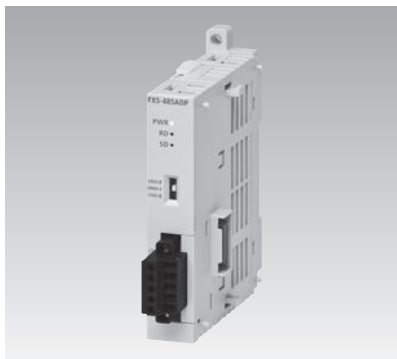

Insulation type RS-485 communication adapter  
Refer to the "N:N network", "Parallel link", "MC Protocol", "Non-protocol communication", "Connection to peripheral device", "Inverter communication function" for more details of functions.

### ◆ Specifications

Items	Specifications
Transmission standard	Conforming to RS-485 and RS-422 standards
Max. transmission distance	1200 m
Insulation	Photocoupler (between communication line and CPU)
External device connection method	European-type terminal block
Communication method	Half-duplex bidirectional/Full-duplex bidirectional
Protocol type	MELSOFT connection, MC protocol (1C/3C/4C frame), non-protocol communication, MODBUS RTU communication, inverter communication, N:N network, parallel link, predefined protocol support
Communication speed	300/600/1200/2400/4800/9600/19200/38400/57600/115200 (bps)*1
Terminal resistors	Built in (OPEN/110 Ω/330 Ω)
No. of occupied I/O points	0 points (no occupied points)
Current consumption (internal supply)	5 V DC 20 mA/24 V DC 30 mA
Compatible CPU module	FX5S, FX5UJ, FX5U, FX5UC: Compatible from initial product
Number of connectable modules	FX5S, FX5UJ, FX5U, FX5UC: Up to 2 communication adapters are provided on the left side of the CPU module.*2
External dimensions W × H × D (mm)	17.6 × 106 × 89.1
MASS (Weight): kg	Approx. 0.08

\*1: The communication method and communication speed vary depending upon the communication type.

\*2: For FX5S, FX5UJ CPU module, when the expansion board is connected, up to one communication adapter can be connected.

# N:N Network

Data links can be easily configured among PLCs by using an RS-485 communication device.

## RS-485 communication device

Model	Types	Compatible CPU module			
		FX5S	FX5UJ	FX5U	FX5UC
FX5-485-BD	Expansion board	○	○	○	×
FX5-485ADP	Expansion adapter	○	○	○	○
—	Built-in RS-485 port	×	×	○	○

## N:N network function

### ◆ Features

- 1) Data link can be realized by a simple program for connecting up to 8 modules of FX5 or FX3.
- 2) The bit device (0 to 64 points) and word device (4 to 8 points) are automatically linked between each station. The ON/OFF state of other stations and data register values can be obtained by the device allocated on the local station.

### ◆ System configuration example

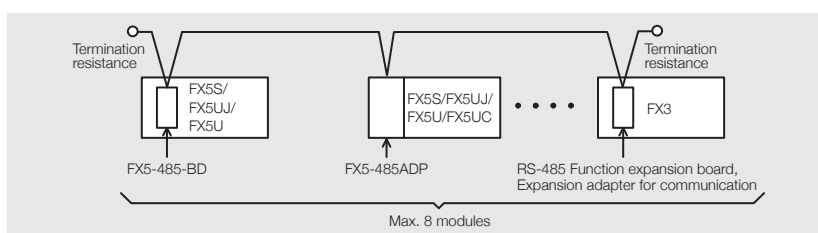

### ◆ Specifications of N:N network function

Items		Specifications
Transmission standard		Conforming to RS-485 standard
Total extension length		Configuration only using FX5-485ADP: 1200 m or less Configuration using FX5-485ADP, FX3U-485ADP(-MB): 500 m or less Configuration other than above: 50 m or less (at coexisting of built-in RS-485 port, FX5-485-BD and 485-BD for FX3: 50 m or less)
Communication method/Transmission speed		Half-duplex bidirectional, 38400 bps
No. of connectable modules		Max. 8 modules
No. of link points	Pattern 0	Bit device: 0 points Word device: 4 points
	Pattern 1	Bit device: 32 points Word device: 4 points
	Pattern 2	Bit device: 64 points Word device: 8 points
Link refresh time (ms)	Pattern 0	Based on the no. of connection modules, 2 modules (20), 3 modules (29), 4 modules (37), 5 modules (46), 6 modules (54), 7 modules (63), 8 modules (72)
	Pattern 1	Based on the no. of connection modules, 2 modules (24), 3 modules (35), 4 modules (45), 5 modules (56), 6 modules (67), 7 modules (78), 8 modules (88)
	Pattern 2	Based on the no. of connection modules, 2 modules (37), 3 modules (52), 4 modules (70), 5 modules (87), 6 modules (105), 7 modules (122), 8 modules (139)
Connection device with PLC	FX5S	FX5-485ADP, FX5-485-BD
	FX5UJ	FX5-485ADP, FX5-485-BD
	FX5U	FX5-485ADP, FX5-485-BD
	FX5UC	FX5-485ADP
	FX3S	FX3G-485-BD(-RJ) or FX3S-CNV-ADP+FX3U-485ADP(-MB)
	FX3G	FX3G-485-BD(-RJ) or FX3G-CNV-ADP+FX3U-485ADP(-MB)
	FX3GC	FX3U-485ADP(-MB)
FX3U, FX3UC*	FX3U-485-BD or Function expansion board+FX3U-485ADP(-MB)	
Compatible CPU module		FX5S, FX5UJ, FX5U, FX5UC, FX3S, FX3G, FX3GC, FX3U, FX3UC

\*: Function expansion board cannot be connected to FX3UC-□□MT/D, FX3UC-□□MT/DSS, and FX3UC-16MR/D□-T. A special adapter can be connected directly.

# Parallel Link

Devices can be mutually linked by connecting two FX5 CPU modules via an RS-485 communication device.

## RS-485 communication equipment

Model name	Classification	Compatible CPU module			
		FX5S	FX5UJ	FX5U	FX5UC
FX5-485-BD	Expansion board	○	○	○	×
FX5-485ADP	Expansion adapter	○	○	○	○
—	Built-in RS-485 port	×	×	○	○

## Parallel link function

### ◆ Features

- 1) With 2 modules of FX5 CPU module connected, devices can be linked to each other only by parameter setting.
- 2) 2 types of link modes, normal parallel link mode and high-speed parallel link mode, can be selected according to the number of points you want to link to and the link time, and the data link is automatically updated between the 2 modules of FX5 CPU module.

### ◆ System configuration example

Parallel link

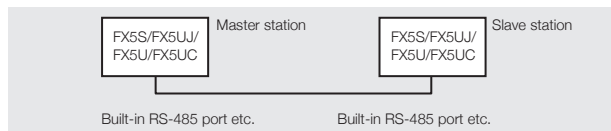

### ◆ Parallel link specifications

Item	Specifications
Number of connected modules	Up to 2 modules (1:1)
Transmission standards	RS-485 standard compliant
Maximum overall cable distance	1200 m or less when configured with FX5-485ADP only 50 m or less when configured other than the above
Link time	Normal parallel link mode: 15 ms + master station operation cycle (ms) + slave station operation cycle (ms) High-speed parallel link mode: 5 ms + master station operation cycle (ms) + slave station operation cycle (ms)

# MC Protocol

Data link of multiple PLCs can be realized by setting a CPU module or external device as a master station using MC protocol (serial communication).

Since data link is done by command from the external device, it is suitable for configuration of data management and control system by the external device as the main controller.

## RS-232C, RS-485 communication device

Model	Types	Compatible CPU module			
		FX5S	FX5UJ	FX5U	FX5UC
FX5-232-BD	Expansion board	○	○	○	×
FX5-232ADP	Expansion adapter	○	○	○	○
FX5-485-BD	Expansion board	○	○	○	×
FX5-485ADP	Expansion adapter	○	○	○	○
—	Built-in RS-485 port	×	×	○	○

## MC protocol function

### ◆ Features

- Using the RS-485 communication device enables connection of up to 16 modules of FX5 CPU module, and data can be transferred according to commands from the PC.
- Using the RS-232C communication device enables 1 : 1 data transfer with the PC.
- Communication by MC protocol A-compatible 1C frame and QnA-compatible-3C/4C frame is possible. (Type 1/Type 4/Type 5)

### ◆ System configuration example

- 1 : n connection using RS-485 communication

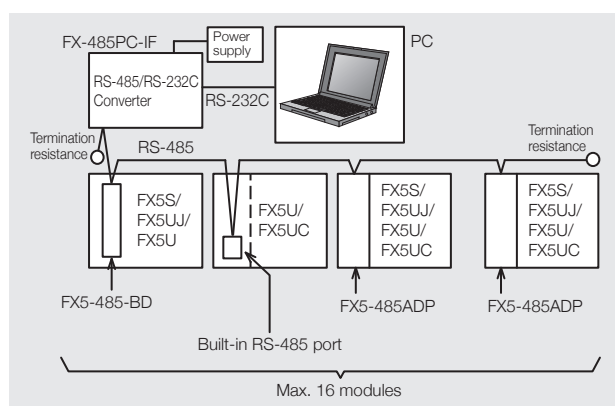

- 1 : 1 connection using RS-232C communication

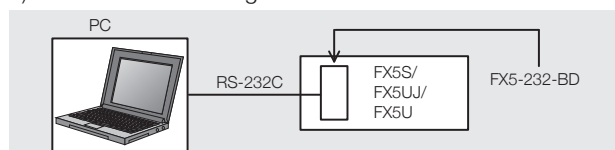

### ◆ MC protocol function specifications



Items		Specifications
Transmission standard		Conforming to RS-485/RS-232C standard
Total extension length	RS-485	When using FX5-485ADP: 1200 m or less When using the built-in RS-485 port or FX5-485-BD: 50 m or less
	RS-232C	15 m or less
Communication method		Half-duplex bidirectional
Transmission speed		300/600/1200/2400/4800/9600/19200/38400/57600/115200 bps
No. of connectable modules		Max. 16 modules
Protocol types		MC protocol (dedicated protocol) 1C/3C Frame (Type1/Type4) / 4C Frame (Type1/Type4/Type5)
RS-485 connection device	FX5S	FX5-485-BD or FX5-485ADP
	FX5UJ	FX5-485-BD or FX5-485ADP
	FX5U	Built-in RS-485 port, FX5-485-BD or FX5-485ADP
	FX5UC	Built-in RS-485 port or FX5-485ADP
RS-232C connection device	FX5S	FX5-232-BD or FX5-232ADP
	FX5UJ	FX5-232-BD or FX5-232ADP
	FX5U	FX5-232-BD or FX5-232ADP
	FX5UC	FX5-232ADP
Compatible CPU module		FX5S, FX5UJ, FX5U, FX5UC

# RS-232C/RS-485 Non-protocol Communication

MELSEC iQ-F Series modules can communicate with printers, code readers, measurement instruments, etc. having an interface in accordance with RS-232C/RS-485 (RS-422). Communication is performed using sequence programs (RS2 instruction).

## RS-232C communication

### ◇ RS-232C communication device

Model (No. of channels)	Communication method	Insulation	Maximum transmission distance	Control instruction	Compatible CPU module			
					FX5S	FX5UJ	FX5U	FX5UC
<b>FX5-232-BD (1 ch)</b> 	Half-duplex bidirectional/ Full-duplex bidirectional	Non-isolation (between communication line and CPU)	15 m	RS2 instruction	○ (Max. 1 module)	○ (Max. 1 module)	○ (Max. 1 module)	×
<b>FX5-232ADP (1 ch)</b> 	Half-duplex bidirectional/ Full-duplex bidirectional	Photocoupler (between communication line and CPU)	15 m	RS2 instruction	○ (Max. 2 modules)	○ (Max. 2 modules)	○ (Max. 2 modules)	○ (Max. 2 modules)

### ◇ Communication specification

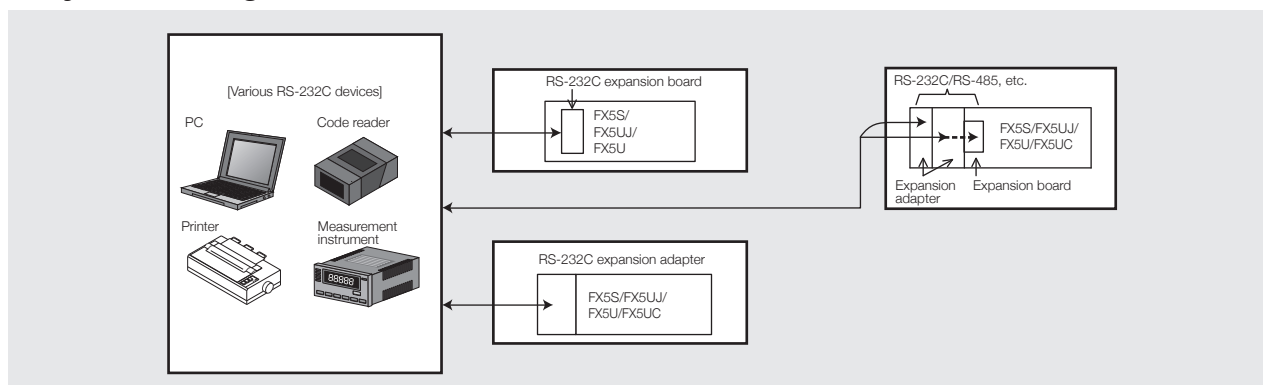

Refer to the specifications of each communication device for the details of RS-232C device specifications.

### ◇ System configuration



RS-485 (RS-422) communication

◇ RS-485 (RS-422) communication device

Model (No. of channels)	Communication method	Insulation	Maximum transmission distance	Control instruction	Compatible CPU module			
					FX5S	FX5UJ	FX5U	FX5UC
<b>FX5-485-BD (1 ch)</b> 	Half-duplex bidirectional/ Full-duplex bidirectional	Non-isolation (between communication line and CPU)	50 m	RS2 instruction	○ (Max. 1 module)	○ (Max. 1 module)	○ (Max. 1 module)	×
<b>FX5-485ADP (1 ch)</b> 	Half-duplex bidirectional/ Full-duplex bidirectional	Photocoupler (between communication line and CPU)	1200 m	RS2 instruction	○ (Max. 2 modules)	○ (Max. 2 modules)	○ (Max. 2 modules)	○ (Max. 2 modules)
<b>Built-in RS-485 port (1 ch)</b> 	Half-duplex bidirectional/ Full-duplex bidirectional	Non-isolation (between communication line and CPU)	50 m	RS2 instruction	×	×	○	○

◇ Communication specification

Refer to the specifications of each communication device for the details of RS-485 device specifications.

◇ System configuration example

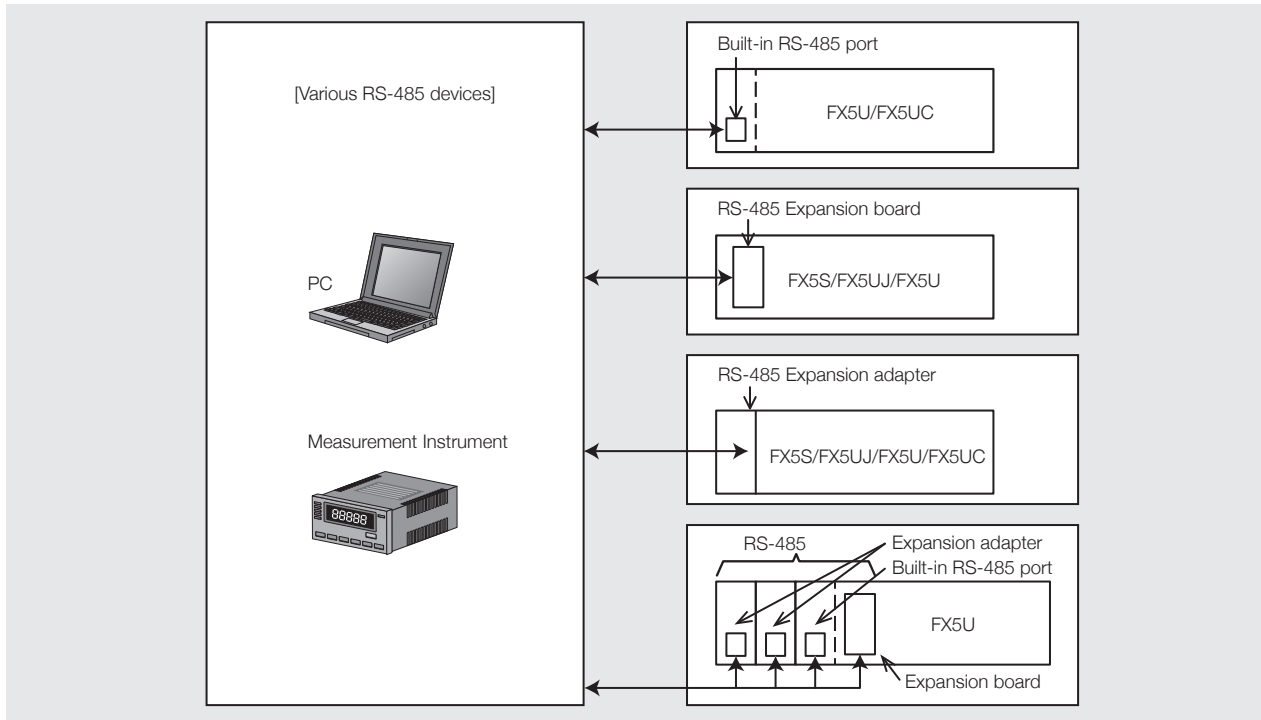



# Connection to Peripheral Devices

Installing RS-422/RS-232C communication devices enables addition of connection ports with peripheral devices. PLC programming devices such as PC and HMI (GOT) can be connected to the added ports.

## RS-232C communication

### ◇ RS-232C communication device

Model (No. of channels)	Communication method	Insulation	Maximum transmission distance	Compatible CPU module			
				FX5S	FX5UJ	FX5U	FX5UC
<b>FX5-232-BD (1 ch)</b> 	Half-duplex bidirectional/ Full-duplex bidirectional	Non-isolation (between communication line and CPU)	15 m	○ (Max. 1 module)	○ (Max. 1 module)	○ (Max. 1 module)	×
<b>FX5-232ADP (1 ch)</b> 	Half-duplex bidirectional/ Full-duplex bidirectional	Photocoupler (between communication line and CPU)	15 m	○ (Max. 2 modules)	○ (Max. 2 modules)	○ (Max. 2 modules)	○ (Max. 2 modules)

### ◇ Communication specification

Refer to the specifications of each communication device for the detailed specifications of RS-232C peripheral devices (programming protocol).

### ◇ Connection cable for RS-232C communication device and peripheral devices

The main connection cables are as follows:

Connection destination	Cable
DOS/V PC (9-pin D-SUB)	FX-232CAB-1
HMI (GOT)	Use the specific cable or wire for RS-232C connection of each HMI.

### ◇ Concurrent use of peripheral device

Connect an engineering tool such as PC software to either one of peripheral devices to avoid programs from being changed by multiple peripheral devices.

## RS-422 (GOT) communication

### ◇ RS-422 communication device

Model (No. of channels)	Communication method	Insulation	Maximum transmission distance	Compatible CPU module			
				FX5S	FX5UJ	FX5U	FX5UC
<b>FX5-422-BD-GOT (1 ch)</b> 	Half-duplex bidirectional	Non-isolation (between communication line and CPU)	As per GOT specifications	○ (Max. 1 module)	○ (Max. 1 module)	○ (Max. 1 module)	×

### ◇ Communication specification

Refer to the manual of GOT.

### ◇ Communication cable

Use a dedicated cable for GOT.





# Inverter Communication Function

Dedicated instructions for Mitsubishi Electric inverter protocol and communication control are built in FX5. Connecting an inverter enables simple control of inverter.

## RS-485 communication

### ◇ RS-485 communication device

Model (No. of channels)	Communication method	Insulation	Maximum transmission distance	Control instruction	Compatible CPU module			
					FX5S	FX5UJ	FX5U	FX5UC
<b>FX5-485-BD (1 ch)</b> 	Half-duplex bidirectional/ Full-duplex bidirectional*	Non-isolation (between communication line and CPU)	50 m	Inverter instruction	○ (Max. 1 module)	○ (Max. 1 module)	○ (Max. 1 module)	×
<b>FX5-485ADP (1 ch)</b> 	Half-duplex bidirectional/ Full-duplex bidirectional*	Photocoupler (between communication line and CPU)	1200 m	Inverter instruction	○ (Max. 2 modules)	○ (Max. 2 modules)	○ (Max. 2 modules)	○ (Max. 2 modules)
<b>Built-in RS-485 port (1 ch)</b> 	Half-duplex bidirectional/ Full-duplex bidirectional*	Non-isolation (between communication line and CPU)	50 m	Inverter instruction	×	×	○	○

\*: Half-duplex bidirection in case of connecting to inverter.

### ◇ System configuration example

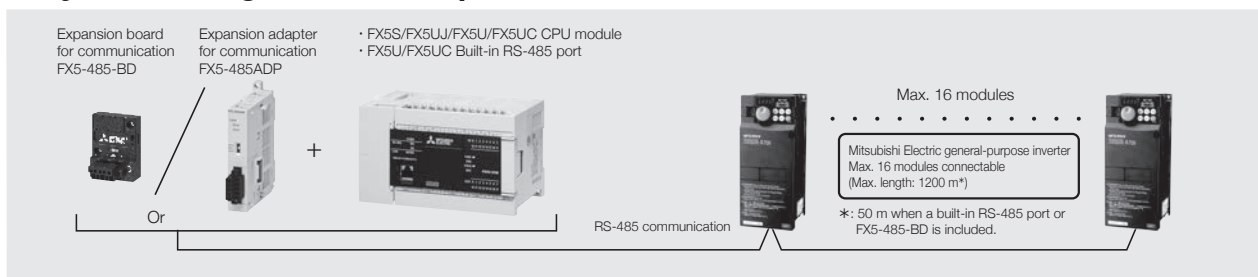

### ● Connectable Mitsubishi Electric general-purpose inverter



#### Inverter

[Connectable Models]  
A800/A800 Plus/F800/E800/F700PJ/E700/E700EX (sensorless servo)/D700

# OPC UA

By installing the OPC UA module (OPC UA server), OPC UA communication with the OPC UA client (an external application or device) can be performed. OPC UA communication is suitable for use in all networks including the Internet due to robust security.

## FX5-OPC type OPC UA module

### ◆ Features



- 1) The FX5U/FX5UC CPU module can be connected to the OPC UA network.
- 2) The OPC UA server can be mounted in the equipment, and a robust system can be configured as an alternative to a PC-based OPC UA server.
- 3) The OPC UA security functions, such as certificate, encryption, and signing, can be used.
- 4) The dedicated setting tool (OPC UA Module Configuration Tool) enables you to set the IP address and security parameters, control the server certificate, and check/change the server status. After the initial setting, GX Works3 is not required. The functions can be operated only via the OPC UA Module Configuration Tool.

### ◆ Specifications

Items		Specifications	
OPC UA server	OPC UA version	1.03	
	Profile	Micro Embedded Device Server Profile For details, refer to the manual.	
	Service	For details, refer to the manual.	
	Address space	For details, refer to the manual.	
	User authentication	User name and password	
	Maximum number of parallel sessions	4	
	Maximum number of subscriptions per session	2	
	Maximum number of monitored items per subscription	500	
	Minimum sampling interval of a monitored item	100 ms	
	Maximum number of trusted certificates	10	
Time information	For details, refer to the manual.		
Network topology	Star topology		
Ethernet	Transmission specifications	Data transmission speed	100/10 Mbps
		Communication mode	Full-duplex or half-duplex*1
		Transmission method	Base band
		Interface	RJ45 connector
		Maximum segment length	100 m*2
	Number of cascade connections	100BASE-TX	2 levels maximum*3
		10BASE-T	4 levels maximum*3
Hub*1	Hubs with 100BASE-TX or 10BASE-T ports*4 can be used.		
Connection cable*5	100BASE-TX, 10BASE-T		
Number of ports	2		
Compatible CPU module	FX5U, FX5UC: Ver. 1.245 or later Connection with FX5UC CPU module requires connector conversion module (FX5-CNV-IFC) or extension power supply module (FX5-C1PS-5V).		
Applicable engineering tool	FX5U, FX5UC: GX Works3 Ver. 1.077F or later OPC UA Module Configuration Tool: Ver. 1.00A or later		
Number of occupied I/O points	8 points (Either input or output is available for counting.)		
Number of connectable modules	FX5U, FX5UC: Up to 1 module		
Power supply	24 V DC, 110 mA (internal power supply)		
External dimensions W × H × D (mm)	40 × 90 × 83		
MASS (Weight): kg	Approx. 0.2		

\*1: IEEE802.3x flow control is not supported.  
 \*2: For maximum segment length (length between hubs), consult the manufacturer of the hub used.  
 \*3: This number applies when a repeater hub is used. When using a switching hub, check the number of cascaded stages with the manufacturer of the hub to be used.  
 \*4: The ports must comply with the IEEE802.3 100BASE-TX or IEEE802.3 10BASE-T standards.  
 \*5: A straight/cross cable can be used.

# Engineering Tool

Various types of engineering software are prepared to enable easy programming for the Mitsubishi Electric PLC and realize comfortable operation.

## MELSOFT iQ Works FA Integrated Engineering Software

● iQ Works (English version) ..... Model: SW2DND-IQWK-E (DVD)

### ◇ Features

- By realization of a seamless integrated engineering environment, the total cost will be reduced.
- All the system labels can be checked on MELSOFT Navigator.
- Parameter settings for each project (GX Works3, GX Works2, MT Works2, and GT Works3) can be configured from MELSOFT Navigator.  
This eliminates the need to launch various tools when configuring the parameter settings.
- System configuration can be managed graphically. Allows the user to manage the system configuration graphically, and the effort to search for an appropriate tool can be eliminated by linking the project.
- Double click the project from the system configuration figure and work space tree of MELSOFT Navigator to start the software for the device automatically.
- The data on whole system can be backed up in a batch by simple operation.

### By realization of a seamless integrated engineering environment, the total cost will be reduced!

Sold as a set integrating various engineering software centered around MELSOFT Navigator, MELSOFT iQ Works eliminates the need to purchase software separately. The ability to share design information including system design and programming throughout the control system makes it possible to improve efficiency of system design and programming while reducing total costs.

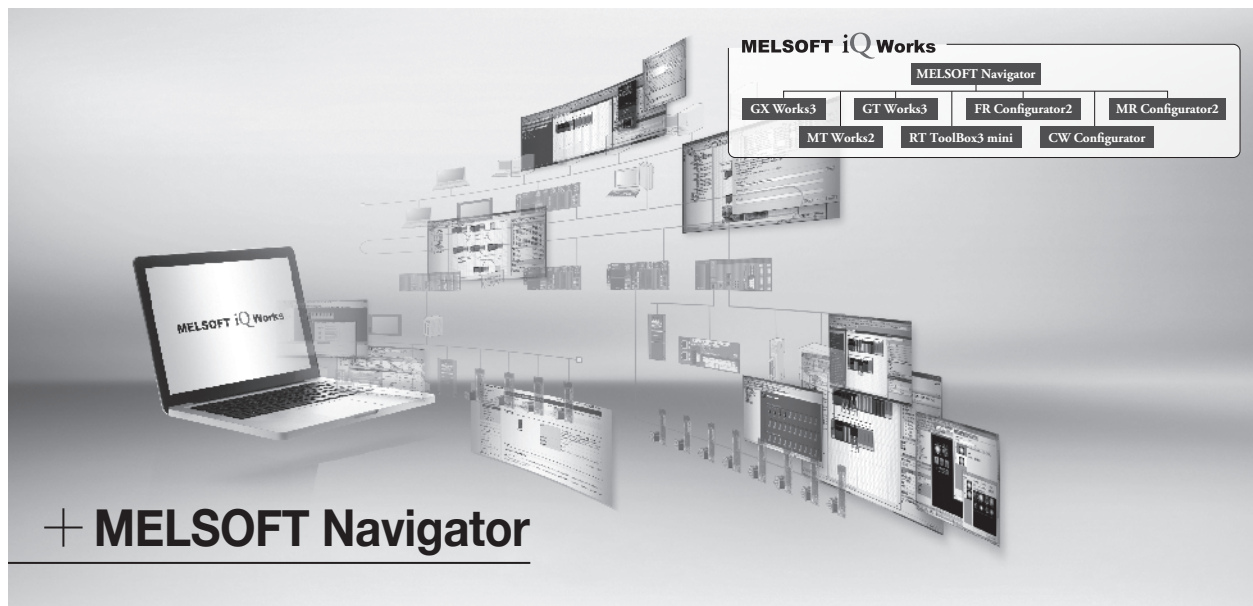

For details on MELSOFT iQ Works, refer to the following catalog:

"MELSOFT iQ Works catalog"  
L(NA)08232ENG



## MELSOFT GX Works3 PLC Engineering Software

● **GX Works3** ..... **Model: SW1DND-GXW3-E (DVD)**

### ◇ Features

- Achieving an easy and intuitive programming by only making "selections" in a graphical environment with module configuration diagram and module label/module FB.
- Supporting various applications (parameter settings of simple motion module, creation of positioning data, parameter setting and servo adjustments of servo amplifier).
- Complying with the international standard IEC 61131-3 for engineering software and supporting the modularized and structured programming. Programming languages such as ladder, ST, FBD/LD, SFC\* are available.
- Enabling transmitting/receiving of the data between an external device and the CPU module by matching the protocol of the external device. (Communication protocol support function)

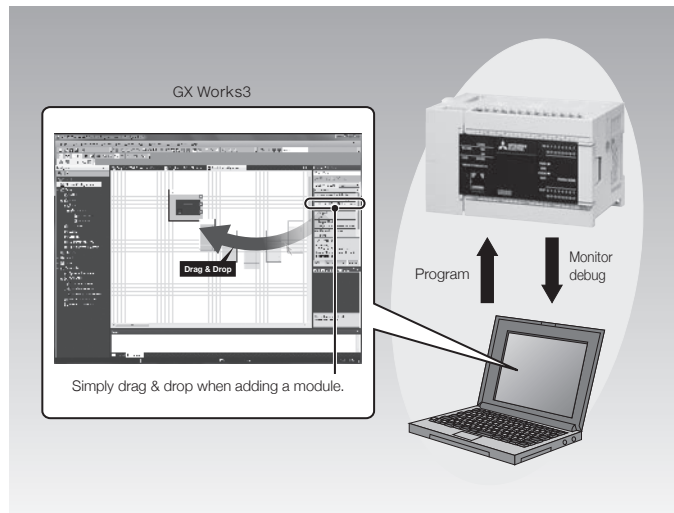

For details on MELSOFT GX Works3, refer to the following catalog available on request

"MELSOFT GX Works3 catalog"  
L(NA)08334ENG



\*: Supported in the FX5U/FX5UC CPU module firmware version 1.220 or later. In addition, GX Works3 version 1.070Y or later is required.

## MELSOFT MX series Integrated Data Link Software

- **MX Component (Communication ActiveX® Library)**  
**MX Component Ver. 4 Model: SW4DNC-ACT-E**  
**MX Component Ver. 5 Model: SW5DND-ACT-E**
- **MX Sheet (Microsoft® Excel® Communication Support Tool)**  
**MX Sheet Ver. 2 Model: SW2DNC-SHEET-E**  
**MX Sheet Ver. 3 Model: SW3DND-SHEET-E**
- **MX Works**  
**A set product of MX Component Ver. 4 and MX Sheet Ver. 2 Model: SW2DNC-SHEETSET-E**  
**A set product of MX Component Ver. 5 and MX Sheet Ver. 3 Model: SW3DNC-SHEETSET-E**

### ◇ Features

- A group of middleware remarkably improving development efficiency in the system configuration.
- Familiar Microsoft® Excel® settings on the screen enables easy data access of the on-site PLC without any program.
- Enabling the system to be configurable without considering a communication protocol.
- Enabling monitoring of on-site system only by setting parameters on the screen.
- Available in the 64-bit application. (MX Component Ver. 5)
- Available in the 64-bit version of Microsoft® Excel®. (MX Sheet Ver. 3)

# Operating Environment

Engineering tool operating environment.  
For details, refer to catalogs and manuals.

## MELSOFT iQ Works and GX Works3 operating environment

Items		Contents		
PC Module	OS English Version	Microsoft® Windows® 11 Home*1*2 Microsoft® Windows® 11 Pro*1*2 Microsoft® Windows® 11 Enterprise*1*2 Microsoft® Windows® 11 Education*1*2 Microsoft® Windows® 10 Home Microsoft® Windows® 10 Pro Microsoft® Windows® 10 Enterprise*3	Microsoft® Windows® 10 Education Microsoft® Windows® 10 IoT Enterprise 2016 LTSB Microsoft® Windows® 8.1 Microsoft® Windows® 8.1 Pro Microsoft® Windows® 8.1 Enterprise Microsoft® Windows® 8 Microsoft® Windows® 8 Pro	Microsoft® Windows® 8 Enterprise Microsoft® Windows® 7 Starter Microsoft® Windows® 7 Home Basic*2 Microsoft® Windows® 7 Home Premium Microsoft® Windows® 7 Professional Microsoft® Windows® 7 Ultimate Microsoft® Windows® 7 Enterprise
	CPU	Intel® Core™2 Duo 2 GHz or more recommended		
	Memory Requirements	For 32-bit version: 1 GB or more recommended For 64-bit version: 2 GB or more recommended (For Microsoft® Windows® 11, 4 GB or more recommended)		
Hard Disc Free Space		[Installation] 26 GB or more*4 free disk space, [Operation] 512 MB or more free virtual memory		
Disc Drive		DVD supported disc drive		
Display		Resolution 1024 × 768 pixels or more		
Connection to PLC		Optional connection cable and interface are necessary. [PC Communication Port] Connectable from Ethernet port, USB (Mini-B) port, or RS-232C port. FX5S, FX5UJ PLC : Directly connectable by Ethernet and USB, or connectable via an RS-232C communication expansion adapter or an RS-232C communication expansion board. FX5U PLC : Directly connectable by Ethernet, or connectable by RS-232C communication expansion adapter or RS-232C communication expansion board. FX5UC PLC : Directly connectable by Ethernet or connectable by RS-232C communication expansion adapter. Refer to the "PC and PLC Connection Method and Required Equipment" for the details of connection method and required cable types.		
Compatible CPU module		FX5S, FX5UJ, FX5U, FX5UC (Refer to the specific catalog or manual for details on FX Series, L Series, Q Series, and iQ-R Series modules.)		

- \*1: Only 64-bit version is supported.
- \*2: Only GX Works3 is supported.
- \*3: For Microsoft® Windows® 10 IoT Enterprise 2016 LTSB, only 64-bit version is supported.
- \*4: 17 GB or more for installing only GX Works3

## PC and PLC Connection Method and Required Equipment

### ◇ In case of connection between Ethernet port on the PC side

Connecting to the Ethernet port

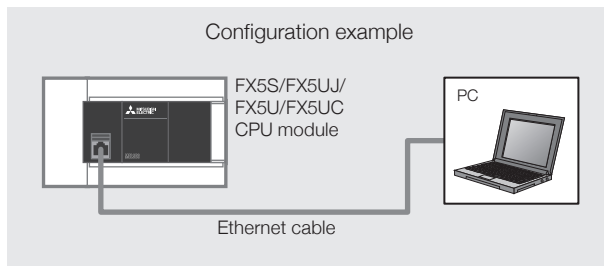

### ◇ In case of connection between USB port on the PC side

Connecting to the USB (Mini-B) port

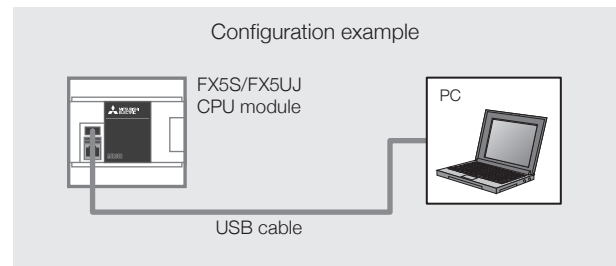

### ◇ In case of connection between RS-232C port on the PC side

(1) Connection with the RS-232C port attached to PLC (using FX5-232ADP)

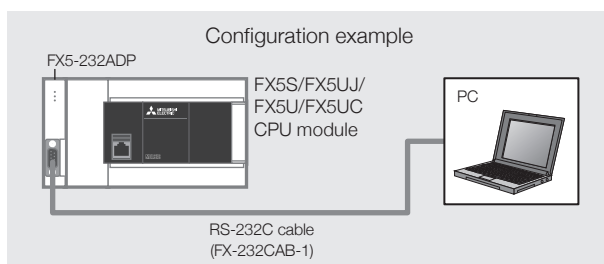

(2) Connection with the RS-232C port attached to PLC (using FX5-232-BD)

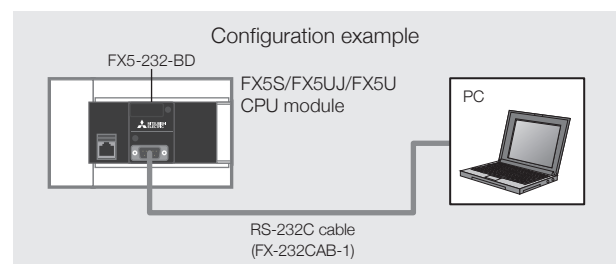

# Compatible Versions of Software

The followings are compatible versions of each software.

New versions may be required due to addition of functions and products. Please refer to the manuals for more details.

Category	Type	Compatible version				Precautions
		FX5S	FX5UJ	FX5U	FX5UC	
Software for PLC	iQ Works	Ver. 2.86Q or later	Ver. 2.62Q or later	Ver. 2.07H or later	Ver. 2.07H or later	Use the latest version when new functions are added.
	GX Works3	Ver. 1.080J or later	Ver. 1.060N or later	Ver. 1.007H or later	Ver. 1.007H or later	
Software for GOT (GOT1000 series, GOT2000 series)	GT Works3	Ver. 1.275M or later	Ver. 1.225K or later	Ver. 1.126G or later	Ver. 1.126G or later	Compatible to the device scope. Refer to the GOT manual for other compatible items.

# Option/Related Products

We are pleased to offer you a wide variety of our products including SD memory cards, batteries, connection cables for PLC as well as interfaces for signal exchange.

## Expansion board (for SD memory card)

Model/feature	Item	Specifications
<b>FX5-SDCD</b> Expansion board for SD memory card. 	SD memory card	NZ1MEM-2GBSD, NZ1MEM-4GBSD, NZ1MEM-8GBSD, NZ1MEM-16GBSD
	Compatible CPU module	FX5S CPU module
	No. of occupied I/O points	0 points (no occupied points)
	External dimensions W × H × D (mm)	43.6 × 51.4 × 15.1
	MASS (Weight): kg	Approx. 16 g

## SD Memory Card



Model/Appearance	Contents		
<b>NZ1MEM-2GBSD</b> <b>NZ1MEM-4GBSD</b> <b>NZ1MEM-8GBSD</b> <b>NZ1MEM-16GBSD</b> 	NZ1MEM-2GBSD	Type	SD memory card
		Capacity	2 GB
	NZ1MEM-4GBSD	Type	SDHC memory card
		Capacity	4 GB
	NZ1MEM-8GBSD	Type	SDHC memory card
		Capacity	8 GB
	NZ1MEM-16GBSD	Type	SDHC memory card
		Capacity	16 GB

## Battery



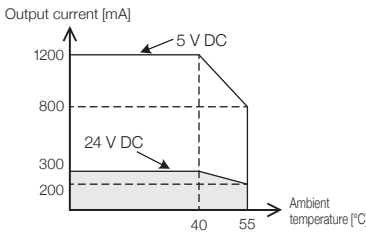

Model/Appearance	Contents
<b>FX3U-32BL</b> 	The battery can be used to retain (latch) the status of the device memory or clock data before a power failure. At the time of delivery from the factory, the battery is not built in the CPU module. Please make arrangements if required. Setting of parameter is required for power failure retention.

## Extension Device

The extension cable for connecting to the right side of the front-stage device has been attached to the extension module (extension cable type).

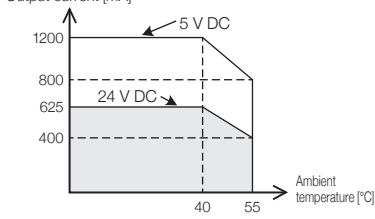
Model/Characteristics	Items	Specifications	
<b>◆ Bus Conversion Module</b>			
<b>FX5-CNV-BUS (FX5 (extension cable type) – FX3 extension)</b>  Conversion module for connecting FX3 extension module to FX5U and FX5UC CPU modules.	Compatible CPU module	FX5U, FX5UC Connection with FX5UC CPU module requires connector conversion module (FX5-CNV-IFC) or extension power supply module (FX5-C1PS-5V).	
	No. of occupied I/O points	8 points (Either input or output is available for counting.)	
	No. of connectable modules	Max. 1 module	
	Current consumption (internal supply)	5 V DC 150 mA	
	External dimensions W × H × D (mm)	16 × 90 × 83	
	MASS (Weight): kg	Approx. 0.1	
	<b>FX5-CNV-BUSC (FX5 (extension connector type) – FX3 extension)</b>  Conversion module for connecting FX3 extension modules to FX5U and FX5UC CPU modules.	Compatible CPU module	FX5U, FX5UC Connection with FX5U CPU module requires connector conversion module (FX5-CNV-IF).
No. of occupied I/O points		8 points (Either input or output is available for counting.)	
No. of connectable modules		Max. 1 module	
Current consumption (internal supply)		5 V DC 150 mA	
External dimensions W × H × D (mm)		16 × 90 × 83	
MASS (Weight): kg		Approx. 0.1	
<b>◆ Extension Power Supply Module</b>			
<b>FX5-1PSU-5V</b>  Module for extending power supply if FX5UJ, FX5U (AC power supply type) CPU module's internal power supply is insufficient. Extension cable is enclosed.  Derating diagram 	Rated power supply voltage	100 to 240 V AC	
	Voltage variation range	-15%, +10%	
	Rated frequency	50/60 Hz	
	Allowable instantaneous power failure time	Operation can be continued upon occurrence of instantaneous power failure for 10 ms or less.	
	Power fuse	250 V 3.15 A time lag fuse	
	Rush current	Max. 25 A 5 ms or less/100 V DC Max. 50 A 5 ms or less/200 V DC	
	Power consumption	Max. 20 W	
	Current output (back-stage supply)	24 V DC	300 mA (Maximum output current depends on the ambient temperature.)
		5 V DC	1200 mA (Maximum output current depends on the ambient temperature.)
	Compatible CPU module	FX5UJ, FX5U (AC power supply type)	
	No. of occupied I/O points	0 points (no occupied points)	
	No. of connectable modules	Max. 2 modules	
	External dimensions W × H × D (mm)	50 × 90 × 83	
	MASS (Weight): kg	Approx. 0.3	



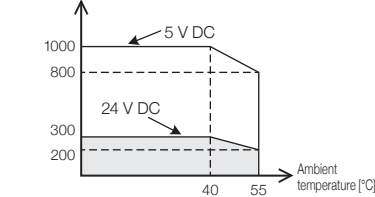

Model/Characteristics	Items	Specifications	
<p><b>FX5-C1PS-5V</b></p>  <p>This is an extension power supply which is added when the built-in power supply of the DC power supply type FX5U/FX5UC CPU module is insufficient. Only one of the connector connection and cable connection can be used for the next-stage extension connector of the extension power supply module.</p> <p>Derating diagram</p> 	Power supply voltage	24 V DC	
	Voltage variation range	+20%, -15%	
	Allowable instantaneous power failure time	Operation can be continued upon occurrence of instantaneous power failure for 5 ms or less.	
	Power fuse	125 V 3.15 A time lag fuse	
	Rush current	Max. 35 A 0.5 ms or less/24 V DC	
	Power consumption	Max. 30 W	
	Current output (back-stage supply)	24 V DC	625 mA (Maximum output current depends on the ambient temperature.)
		5 V DC	1200 mA (Maximum output current depends on the ambient temperature.)
	Compatible CPU module	FX5U (DC power supply type), FX5UC	
	No. of occupied I/O points	0 points (no occupied points)	
	No. of connectable modules	Max. 2 modules	
	External dimensions W × H × D (mm)	20.1 × 90 × 74	
	MASS (Weight): kg	Approx. 0.1	
<b>◆ Connector Conversion Module</b>			
<p><b>FX5-CNV-IF (FX5 (extension cable type) – FX5 (extension connector type))</b></p>  <p>Converts the connector for connecting an extension connector type for FX5.</p>	Compatible CPU module	FX5UJ, FX5U	
	No. of occupied input/output points	0 points (No occupied I/O)	
	No. of connectable modules	Max. 1 module	
	Current consumption (internal supply)	0 mA (no power consumed)	
	External dimensions W × H × D (mm)	14.6 × 90 × 74	
	MASS (Weight): kg	Approx. 0.06	
<p><b>FX5-CNV-IFC (FX5 (extension connector type) – FX5 (extension cable type))</b></p>  <p>Converts the connector for connecting an extension cable type for FX5.</p>	Compatible CPU module	FX5UC	
	No. of occupied I/O points	0 points (No occupied I/O)	
	No. of connectable modules	Max. 1 module	
	Current consumption (internal supply)	0 mA (no power consumed)	
	External dimensions W × H × D (mm)	14.6 × 90 × 74	
	MASS (Weight): kg	Approx. 0.06	
<b>◆ Extension Power Supply Module (for FX3 Extension Module)</b>			
<p><b>FX3U-1PSU-5V</b></p>  <p>For extension of power supply when power supply for FX3 extension module is insufficient.</p> <p>Derating diagram</p> 	Power supply voltage	100 to 240 V AC	
	Allowable power supply voltage range	85 to 264 V AC	
	Rated frequency	50/60 Hz	
	Allowable instantaneous power failure time	Conditions vary depending on power sources as follows: <ul style="list-style-type: none"> <li>100 V AC power supply: Operation can be continued upon occurrence of instantaneous power failure for 10 ms or less.</li> <li>200 V AC power supply: Operation can be continued upon occurrence of instantaneous power failure for 100 ms or less.</li> </ul>	
	Rush current	Max. 30 A 5 ms or less/100 V AC Max. 65 A 5 ms or less/200 V AC	
	Power consumption	Max. 20 W	
	Current output (back-stage supply)	24 V DC	0.3 A (Derate the maximum output current at an ambient temperature of 40°C or above.)
		5 V DC	1 A (Derate the maximum output current at an ambient temperature of 40°C or above.)
	Compatible CPU module	FX5U (AC power supply type)	
	No. of occupied I/O points	0 points (no occupied points)	
	No. of connectable modules	Max. 2 modules When an FX5 extension power supply module is used, two modules including the FX5 extension power supply module in total can be connected.	
	External dimensions W × H × D (mm)	55 × 90 × 87	
	MASS (Weight): kg	Approx. 0.3	

## Extension Module Options (Extended Extension Cables/Connector Conversion Adapters)

FX5 extension modules (extension cable type) are equipped with the extension cable for connection to the right side of the front-stage device.

If intending extension of the connection distance or two-row placement of PLCs, an optional "Extended extension cable" is required. Only a single extended extension cable can be used per system.

### ◇ Extended extension cable

Model	Specifications
<b>FX5-30EC (30 cm)</b> <b>FX5-65EC (65 cm)</b> 	◇Extended extension cable Extension cable for the FX5 extension module. Only a single cable can be used per system. Depending on the CPU module to be used or the device to be connected with, the following connection conversion adapter (FX5-CNV-BC) is required. [Connector conversion adapter required] When the connection destination is an input/output module (extension cable type), high-speed pulse I/O module, or FX5 intelligent function module
<b>FX5-CNV-BC</b> 	●Connector conversion adapter This connects between an extension cable and an extension cable type module when an extended extension cable is used.

### ◇ Main connection methods

1) Connections with the Powered I/O module and FX5 extension power supply module (extension cable type)

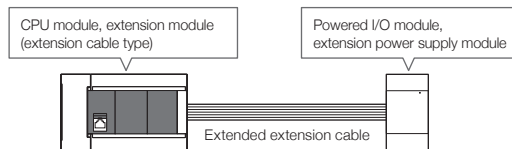

2) Connections with the input/output module (extension cable type) and FX5 intelligent function module

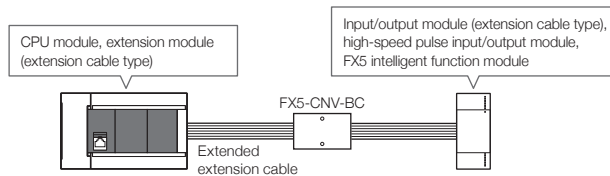

3) Connections with the input/output module (extension cable type) and FX5 intelligent function module

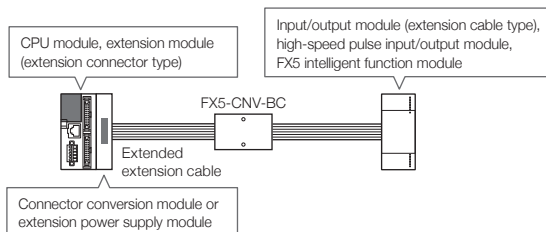

## Terminal Block

This allows conversion of the connector of the FX5UC CPU module or the I/O module (extension connector type) to the screw terminal block, resulting in the reduced number of man-hours for I/O wiring. Using an internal type of I/O element enables driving of a heavy load by a relay or a transistor.

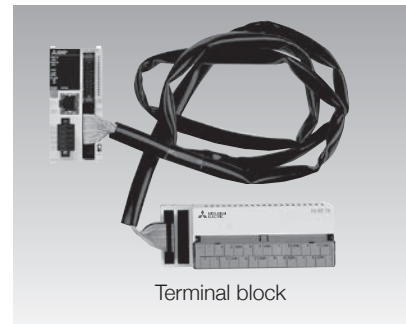

Terminal block

### ◇ List of Terminal Blocks (Refer to the next page for the details of connection cables and optional connectors.)

Model	No. of input points	No. of output points	Function
FX-16E-TB	Input 16 points or output 16 points		Directly connected to the I/O terminal of PLC.
FX-32E-TB	Input 32 points or output 32 points (Division possible: input 16 points and output 16 points)		Using this module instead of the PLC terminals or relaying a wiring of I/O device located remotely from PLC enables reducing of the I/O wiring man-hours.
FX-16E-TB/UL	Input 16 points or output 16 points		
FX-32E-TB/UL	Input 32 points or output 32 points (Division possible: input 16 points and output 16 points)		
FX-16EYR-TB	—	16	Relay Output Type
FX-16EYS-TB	—	16	Triac Output Type
FX-16EYT-TB	—	16	Transistor Output Type (Sink output)
FX-16EYR-ES-TB/UL	—	16	Relay Output Type
FX-16EYS-ES-TB/UL	—	16	Triac Output Type
FX-16EYT-ESS-TB/UL	—	16	Transistor Output Type (Source output)

### ◇ Specifications

#### 1. PLC Direct Connection (FX-16E-TB, FX-32E-TB)

Since it is for direct connection of PLC I/O terminal, no electrical components are built in.

Electrical specifications are equivalent to that of the connected CPU module or connector type I/O module. A drawing on the right shows the internal connection of FX-16E-TB. In the case of FX-32E-TB, it is connected to CN2 in the same manner.

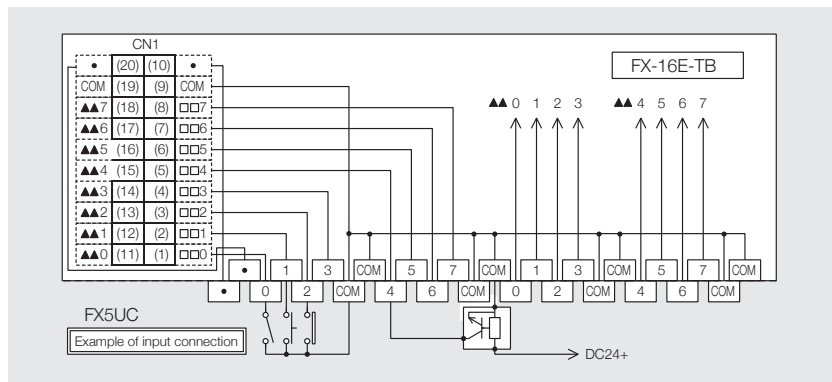



#### 2. Output (FX-16EY□-TB)



Model	Relay output FX-16EYR-TB	Triac output FX-16EYS-TB	Transistor output (Sink output) FX-16EYT-TB
I/O circuit configuration			
Load voltage	250 V AC 30 V DC or less	85 V to 242 V AC	5 V to 30 V DC
Circuit insulation	Mechanical insulation	Photocopler	Photocopler
Operation display	An LED is turned on when applying an electrical current to a relay coil	An LED is turned on when applying an electrical current to a photthyristor	An LED is turned on when applying an electrical current to a photocopler
Max. load	Resistance load	0.3 A/1 point 0.8 A/4 points	0.5 A/1 point 0.8 A/4 points
	Inductive load	80 VA	15 VA/100 V AC, 36VA/240 V AC
Open circuit leakage current	—	1 mA/A100 V AC, 2 mA/200 V AC	0.1 mA/30 V DC
Min. load	5 V DC, 2 mA (reference value)	0.4 VA/100 V AC, 1.6 VA/200 V AC	—
Response time	OFF → ON	Approx. 10 ms	2 ms or less
	ON → OFF	Approx. 10 ms	12 ms or less
Input signal current	5 mA/24 V DC for each point (current consumption)	7 mA/24 V DC for each point (current consumption)	7 mA/24 V DC for each point (current consumption)

## Option/Related Products

### I/O Cable

Model/Appearance	Contents
<b>FX-16E-500CAB-S (5 m)</b> 	<ul style="list-style-type: none"> <li>● General-purpose I/O cable</li> </ul> <p>A 20-pin connector attached to one end of bulk wire</p>
<b>FX-16E-150CAB (1.5 m)</b> <b>FX-16E-300CAB (3 m)</b> <b>FX-16E-500CAB (5 m)</b> 	<ul style="list-style-type: none"> <li>● I/O cable for Terminal block</li> </ul> <p>A 20-pin connector attached to both ends of a flat cable (with tube)</p>
<b>FX-16E-150CAB-R (1.5 m)</b> <b>FX-16E-300CAB-R (3 m)</b> <b>FX-16E-500CAB-R (5 m)</b> 	<ul style="list-style-type: none"> <li>● I/O cable for Terminal block</li> </ul> <p>A 20-pin connector attached to both ends of round multi core cable</p>

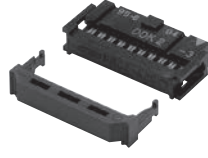

### I/O Connector

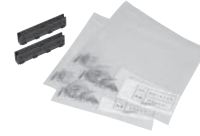
Model/Appearance	Contents
<ul style="list-style-type: none"> <li>◆ Connector for self-manufactured I/O cable 20-pin type (electric wire or crimp tool is not enclosed.)</li> </ul>	
<b>FX2C-I/O-CON</b> 	<ul style="list-style-type: none"> <li>● Flat cable connector</li> </ul> <ul style="list-style-type: none"> <li>• AWG28 (0.1 mm<sup>2</sup>): A set of 10 pcs</li> <li>• Crimp connector: FRC2-A020-3OS 1.27-pitch 20 cores</li> <li>• Crimp tool: Separately arrange the tool manufactured by DDK Ltd. 357J-4674D Main Module 357J-4664N Attachment</li> </ul>
<b>(1) FX2C-I/O-CON-S</b> <b>(2) FX2C-I/O-CON-SA</b> 	<p>(1) Connector for single wires AWG22 (0.3 mm<sup>2</sup>): 5 sets</p> <ul style="list-style-type: none"> <li>• Housing: HU-200S2-001</li> <li>• Crimp contact: HU-411S</li> <li>• Crimp tool: A product manufactured by DDK Ltd. is separately required. 357J-5538</li> </ul> <p>(2) Connector for single wires AWG20 (0.5 mm<sup>2</sup>): 5 sets</p> <ul style="list-style-type: none"> <li>• Housing: HU-200S2-001</li> <li>• Crimp contact: HU-411SA</li> <li>• Crimp tool: A product manufactured by DDK Ltd. is separately required. 357J-13963</li> </ul>

Model/Appearance	Contents
<ul style="list-style-type: none"> <li>◆ Connector for self-manufactured I/O cable: 40-pin type (electric wire or crimp tool is not enclosed.)</li> </ul>	
<b>(1) A6CON1*</b> <b>(2) A6CON2</b> <b>(3) A6CON4*</b>  For FX5-20PG-P, FX5-20PG-D	<p>(1) Soldered type connector (straight protrusion) Twist wire 0.088 to 0.3 mm<sup>2</sup> (AWG28 to 22)</p> <p>(2) Crimped type connector (straight protrusion) Twist wire 0.088 to 0.24 mm<sup>2</sup> (AWG28 to 24)</p> <p>(3) Soldered type connector (both straight/inclined protrusion type) Twist wire 0.088 to 0.3 mm<sup>2</sup> (AWG28 to 22)</p>
<b>(1) FX-I/O-CON2-S</b> <b>(2) FX-I/O-CON2-SA</b>  (For FX3U-2HC)	<p>(1) Connector for single wires AWG22 (0.3 mm<sup>2</sup>): 2 sets</p> <ul style="list-style-type: none"> <li>• Housing: HU-400S2-001</li> <li>• Crimp contact: HU-411S</li> <li>• Crimp tool: A product manufactured by DDK Ltd. is separately required. 357J-5538</li> </ul> <p>(2) Connector for single wires AWG20 (0.5 mm<sup>2</sup>): 2 sets</p> <ul style="list-style-type: none"> <li>• Housing: HU-400S2-001</li> <li>• Crimp contact: HU-411SA</li> <li>• Crimp tool: A product manufactured by DDK Ltd. is separately required. 357J-13963</li> </ul>

\*: Select wires with a sheath outside diameter of 1.3 mm or less when using 40 wires. Select wires suitable to the current value used.

## Power Cable

Model/Appearance	Contents
<b>FX2NC-100MPCB (1 m)</b> 	<ul style="list-style-type: none"> <li>●CPU module power cable</li> </ul> <p>Cable for providing 24 V DC power supply to the FX5UC CPU module. Comes with the FX5UC CPU modules and intelligent function modules*.</p>
<b>FX2NC-100BPCB (1 m)</b> 	<ul style="list-style-type: none"> <li>●Power cable</li> </ul> <p>Cable for supplying 24 V DC input power supply to an extension connector type input module or input/output module. Offered as an accessory of FX5UC-□MT/D. It is necessary to purchase this cable separately when using an extension connector type input module or input/output module in the FX5U system.</p>
<b>FX2NC-10BPCB1 (0.1 m)</b> 	<ul style="list-style-type: none"> <li>●Power supply transition cable</li> </ul> <p>Cable for crossover wiring of 24 V DC input power supply to two or more extension connector type input modules or input/output modules. Offered as an accessory of FX5-C□EX/D and FX5-C32ET/D.</p>





\*: There are some exception models. For details, refer to the manual.

## Communication cable

Model/Appearance	Contents
<b>FX-232CAB-1 (3 m)</b> 	<ul style="list-style-type: none"> <li>●RS-232C connection cable for personal computer</li> </ul> <p>Cable for connecting between FX5 PLC and personal computer through RS-232C communication D-sub 9-pin (female) ⇔ D-sub 9-pin (female) (for DOS/V, etc.)</p>
<b>MR-J3USBCBL3M (3 m)</b>	<ul style="list-style-type: none"> <li>●Personal computer communication cable (USB cable)</li> </ul> <p>Cable for connecting between FX5S/FX5UJ CPU module and personal computer through USB communication CPU module (built-in connector for USB communication) ⇔ personal computer</p>
<b>GT09-C30USB-5P (3 m)</b>	<ul style="list-style-type: none"> <li>●Data transfer cable</li> </ul> <p>Cable for connecting between FX5S/FX5UJ CPU module and personal computer through USB communication CPU module (built-in connector for USB communication) ⇔ personal computer Made by Mitsubishi Electric System &amp; Service Co., Ltd.</p>

## Option/Related Products

### Related products Reduced wiring and man-hour saving machines for programmable controllers (FA goods) [manufactured by Mitsubishi Electric Engineering Co., Ltd.]

Model/external appearance	Description
<b>FA-CBLQ75PM2J3 (2 m)</b> <b>FA-CBLQ75M2J3 (-P) (2 m)</b> 	<ul style="list-style-type: none"> <li>●Connection cable</li> </ul> <p>Mitsubishi Electric MR-J3-A/J4-A series</p> <ul style="list-style-type: none"> <li>●Connectable models</li> </ul> <p>FA-CBLQ75PM2J3: FX5-20PG-P            FA-CBLQ75M2J3 (-P): FX5-20PG-D</p>
<b>FA-CBLQ75G2 (-P) (2 m)</b> 	<ul style="list-style-type: none"> <li>●Connection cable</li> </ul> <p>General-purpose stepping motor, discrete wire cable for servo amplifier</p> <ul style="list-style-type: none"> <li>●Connectable models</li> </ul> <p>FX5-20PG-P, FX5-20PG-D</p>
<b>FA-LTBQ75DP</b> 	<ul style="list-style-type: none"> <li>●Positioning signal conversion module</li> </ul> <p>Converts the external device connection signal of the positioning module to the terminal block and converts the signal between the servo amplifiers to the connect.</p>
<b>FA-CBL05Q7 (0.5 m)</b> <b>FA-CBL10Q7 (1 m)</b> 	<ul style="list-style-type: none"> <li>●Connection cable</li> </ul> <p>Positioning module ⇔ Connection cable between positioning signal conversion modules</p>
<b>FA-CBLQ7PM1J3 (1 m)</b> <b>FA-CBLQ7DM1J3 (1 m)</b> 	<ul style="list-style-type: none"> <li>●Connection cable</li> </ul> <p>Positioning signal conversion module ⇔ Connection cable between servo amplifiers (for Mitsubishi Electric MR-J3-A/J4-A series)</p>
<b>FA-CBLQ7DG1 (1 m)</b> 	<ul style="list-style-type: none"> <li>●Connection cable</li> </ul> <p>Positioning signal conversion module ⇔            Connection cable between servo amplifiers (for general-purpose stepping motor and servo amplifier)</p>

# Technical information

## Function Block library

The FB library is a set of program parts for PLC.

For Function Block library, please consult your local Mitsubishi representative.

For the specifications and functions of the FB, refer to the attached reference manual and the reference manual for each module.

### ◇ Function Block list

Library name	Overview	Compatible CPU module			
		FX5S	FX5UJ	FX5U	FX5UC
FX5 CPU module Function Block	Module FB (for GX Works3) for using the input/output, positioning, serial communication, high-speed counter, and temperature control of the CPU module.	○	○	○	○
Multiple input module Function Block	The module Function Blocks (for GX Works3) to use the multiple input module (FX5-8AD).	—	○	○	○
Analog input module Function Block	The module Function Blocks (for GX Works3) to use the analog input module (FX5-4AD).	—	○	○	○
Analog output module Function Block	The module Function Blocks (for GX Works3) to use the analog output module (FX5-4DA).	—	○	○	○
FX5 Ethernet-equipped module Function Block	The module Function Blocks (for GX Works3) to use the FX5 Ethernet-equipped module.	○	○	○	○
FX5-ENET Ethernet-equipped module Function Block	The module Function Blocks (for GX Works3) to use the FX5 Ethernet module.	—	○	○	○
FX5 EtherNet/IP-equipped module Function Block	The module Function Blocks (for GX Works3) to use the FX5 EtherNet/IP module.	—	○	○	○
CC-Link IE TSN module Function Block	The module Function Blocks (for GX Works3) to use the CC-Link IE TSN module.	—	—	○	○
CC-Link IE Field Network module Function Block	The module Function Blocks (for GX Works3) to use the CC-Link IE Field Network module.	—	○	○	○
Positioning module Function Block	The module Function Blocks (for GX Works3) to use the positioning module.	—	○	○	○
Simple motion module Function Block	The module Function Blocks (for GX Works3) to use the simple motion module.	—	○	○	○
FB for replacement with FX2N-20GM	FB library for using the functions of FX2N-20GM using the positioning function module (FX5-20PG-□).	—	○	○	○
Statistical analysis Function Block	FB library for statistical analysis using the CPU module.	○	○	○	○
Cam output control Function Block	FB library for using the cam output control functions using the CPU module.	—	—	○	○
FB for inverter compatible with CC-Link IE Field Network Basic	FB library for using the inverter compatible with CC-Link IE Field Network Basic through the built-in Ethernet in the CPU module.	○	○	○	○
PLCopen Motion Control Function Block	FB library for using the servo amplifier compatible with CC-Link IE Field Network Basic through the Ethernet of the Ethernet-equipped module.	○	○	○	○
e-F@ctory Starter Package* Overall equipment effectiveness monitor	Sample program for displaying overall equipment effectiveness, availability, performance rate, finished good ratio, ratio of non-operating time to operating time of equipment, and production information, and for collectively monitoring the equipment operation condition.	—	—	○	○
e-F@ctory Starter Package* Cylinder & cycle time measurement monitor	Sample program for measuring and monitoring the cylinder operating time and equipment cycle time.	—	—	○	○
e-F@ctory Starter Package* Pareto chart for equipment troubles	A sample program that gives priorities to alarms generated by equipment and shows it in a Pareto chart, to make it easier to find the trouble factors which reduce production efficiency.	—	—	○	○
Predefined protocol support for positioning Function Block (IAI)	FB library for connecting and using the CPU module and IAI's Robo Cylinder via MODBUS RTU communication.	—	—	○	○
Predefined protocol support for positioning Function Block (SMC)	FB library for connecting and using the CPU module and SMC's electric actuator via MODBUS RTU communication.	—	—	○	○
Predefined protocol support for positioning Function Block (ORIENTAL MOTOR)	FB library for connecting and using the CPU module and ORIENTAL MOTOR's electric actuator via MODBUS RTU communication.	—	—	○	○

\*: Please consult your local Mitsubishi representative.

For the latest information on each FB and its compatibility, please consult your local Mitsubishi representative.

**Technical information**

**memo**



# Overseas Service System

Mitsubishi Electric's Micro PLC Series is a worldwide programmable controller that is used in more than 50 countries all over the world.

For local after-sales services in the overseas countries, "Mitsubishi Electric Global FA Centers" timely provide the best possible products, high technology and reliability services to our customers.

## Global FA Center

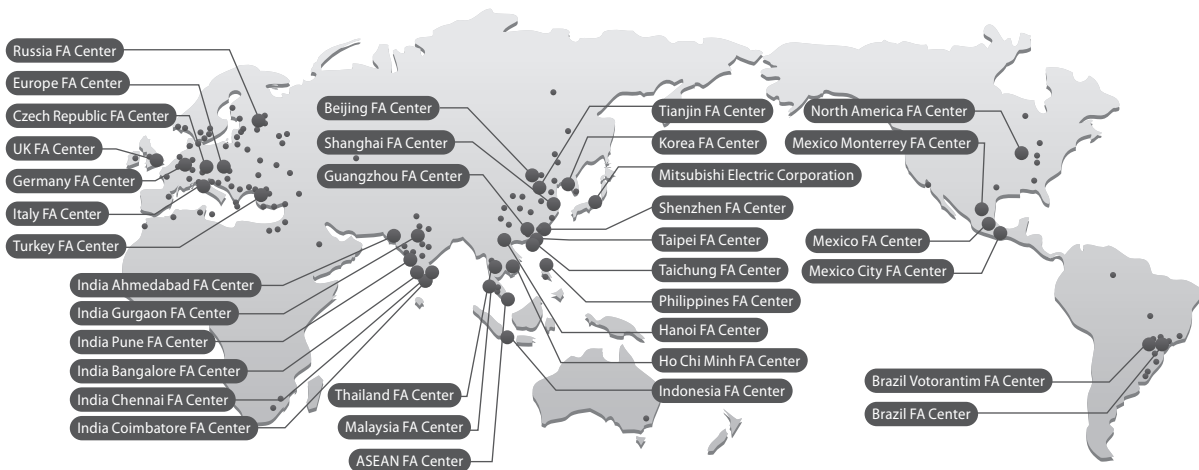

### ◆ FA Global Service Network "Place contact our FA Center first."

For consultation and questions, please contact our FA centers in each country. With our FA centers in each region of the world as key stations, we provide various services to customers while working closely with local sales offices, branches and agencies.

### ◆ Detailed information on overseas service

"FA global service" (KK001-EN)  
Service contents and contact information of our FA centers are detailed.  
For more information on overseas support, please request this document.

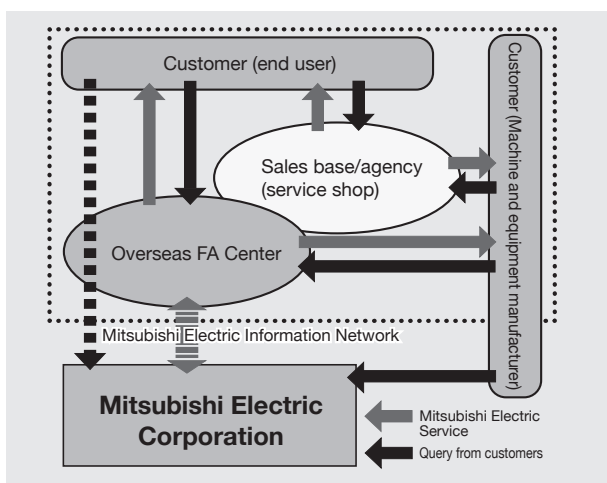

# Certifications

MELSEC iQ-F Series conforms to European Standards (EN) and North American Standards (UL/cUL).

Using MELSEC iQ-F Series can reduce the workload to make machines/equipment conform to EN and UL/cUL standards.

## ◇ Compatible with international standards

The MELSEC iQ-F series conforms to CE marking (Europe) and UL/cUL standard (USA, Canada) and therefore can be used for overseas facilities.



## ◇ EN standards: Compliance with EC Directives/CE marking

EC directives are issued by the European Council of Ministers for the purpose of unifying European national regulations and smoothing distribution of safe guaranteed products. Approximately 20 types of major EC directives concerning product safety have been issued.

The EMC Directive (Electromagnetic Compatibility Directive), LVD Directive (Low Voltage Directive), RoHS Directive (Restriction of Hazardous Substances Directive), and MD Directive (Machinery Directive) are applied to the programmable controller, which is labeled as an electrical part of a machine product under the EC Directives.

### 1) EMC Directive

The EMC Directive is a directive that requires products to have “Capacity to prevent output of obstructive noise that adversely affects external devices: Emission damage” and “Capacity to not malfunction due to obstructive noise from external source: Immunity”.

### 2) LVD (Low Voltage Directive)

The LVD Directive is enforced to distribute safe products that will not harm or damage people, objects or assets, etc. With the programmable controller, this means a product that does not pose a risk of electric shock, fire or injury, etc.

### 3) RoHS Directive

The RoHS Directive is issued by the European Parliament and Council on the restriction of the use of the certain hazardous substances in electrical and electronic equipment. Electrical and electronic equipment products must not include the certain hazardous substances.

### 4) MD (Machinery Directive)

The MD Directive is for machines and machine parts that may cause injury to the operator due to mechanical moving parts. Safety control equipment must be certified by a recognized body.



### ◇ UL/cUL Standards

UL is the United State's main private safety testing and certification agency for ensuring public safety.

UL sets the safety standards for a variety of fields. Strict reviews and testing are performed following the standards set forth by UL. Only products which pass these tests are allowed to carry the UL Mark.

As opposed to the EN Standards, the UL Standards do not have a legally binding effect. However, they are broadly used as the U.S. safety standards, and are an essential condition for selling products into the U.S.

UL is recognized as a certifying and testing agency by the Canadian Standards Association (CSA). Products evaluated and certified by UL in accordance with Canadian standards are permitted to carry the cUL Mark.

[Precautions on the use in UL/cUL Class I, Division 2 environment]

Products\* marking Cl. I, DIV.2 indicating that they can be used in the Class I, Division 2 (filling in a flammable environment in case of abnormalities) on the rating plate can be used in Class I, Division 2 Group A, B, C, and D only. They can be used regardless of the display as long as they do not reach the danger.

Note that when using a product in Class I, Division 2 environment, the following measures need to be taken for the risk of explosion.

- As this product is an open-type device, attach it to the control board suitable for the installation environment and, for opening, to the control board which requires a tool or key.
- Substitution of products other than Class I, Division 2 compatible may result in degradation of Class I, Division 2 compliance. Therefore, do not substitute products other than compatible products.
- Do not disconnect/connect the device or disconnect the external connection terminal except when the power is turned off or where there is no danger.
- Do not open the battery except where it is out of reach of danger.



\*: UL explosion-proof standard compliant products are as follows. (Manufactured in October 2017 and after)

- FX5U CPU module
- FX5UC-32MT/D, FX5UC-32MT/DSS, FX5UC-64MT/D, FX5UC-64MT/DSS, FX5UC-96MT/D, and FX5UC-96MT/DSS
- FX5 extension module
- FX5-C16EX/D, FX5-C16EX/DS, FX5-C16EYT/D, FX5-C16EYT/DSS, FX5-C32EX/D, FX5-C32EX/DS, FX5-C32EYT/D, FX5-C32EYT/DSS, FX5-C32ET/D, FX5-C32ET/DSS, FX5-232ADP, FX5-485ADP, FX5-C1PS-5V, FX5-CNV-BUSC, FX5-4AD-ADP, and FX5-4DA-ADP

### ◇ Ship standards

The MELSEC iQ-F series complies with the shipping standards of each country.

It can be used for ship-related machinery and equipment.

Standard abbreviation	Standard name	Target country
DNV	DNV AS	Norway/Germany
RINA	REGISTRO ITALIANO NAVALE	Italy
ABS	American Bureau of Shipping	U.S.A.
LR	Lloyd's Register of Shipping	U.K.
BV	Bureau Veritas	France
NK	Nippon Kaiji Kyokai	Japan
KR	Korea Ship Association	Korea

### ◇ Korean Certification Mark (KC Mark)

- The KC mark, which is a safety certification mark required to be affixed to the specified products distributed in Korea (products required to be legally certificated for safety, quality, environment, etc.), indicates compliance with various requirements.
- KC mark is indicated on FA products, which conform to the Radio Act. Note that other standards are not applicable.

List of compatible products

Model	CE			UL cUL	KC	Ship approvals							
	EMC	LVD	RoHS			ABS	DNV	LR	BV	RINA	NK	KR	
◆FX5S CPU modules													
FX5S-30MR/ES	○	○	○	○	○	—	—	—	—	—	—	—	
FX5S-30MT/ES	○	○	○	○	○	—	—	—	—	—	—	—	
FX5S-30MT/ESS	○	○	○	○	○	—	—	—	—	—	—	—	
FX5S-40MR/ES	○	○	○	○	○	—	—	—	—	—	—	—	
FX5S-40MT/ES	○	○	○	○	○	—	—	—	—	—	—	—	
FX5S-40MT/ESS	○	○	○	○	○	—	—	—	—	—	—	—	
FX5S-60MR/ES	○	○	○	○	○	—	—	—	—	—	—	—	
FX5S-60MT/ES	○	○	○	○	○	—	—	—	—	—	—	—	
FX5S-60MT/ESS	○	○	○	○	○	—	—	—	—	—	—	—	
◆FX5UJ CPU modules													
FX5UJ-24MR/ES	○	○	○	○	○	○	○	○	○	—	○	—	
FX5UJ-24MT/ES	○	○	○	○	○	○	○	○	○	—	○	—	
FX5UJ-24MT/ESS	○	○	○	○	○	○	○	○	○	—	○	—	
FX5UJ-40MR/ES	○	○	○	○	○	○	○	○	○	—	○	—	
FX5UJ-40MT/ES	○	○	○	○	○	○	○	○	○	—	○	—	
FX5UJ-40MT/ESS	○	○	○	○	○	○	○	○	○	—	○	—	
FX5UJ-60MR/ES	○	○	○	○	○	○	○	○	○	—	○	—	
FX5UJ-60MT/ES	○	○	○	○	○	○	○	○	○	—	○	—	
FX5UJ-60MT/ESS	○	○	○	○	○	○	○	○	○	—	○	—	
◆FX5U CPU modules													
FX5U-32MR/ES	○	○	○	○	○	○	○	○	○	○	○	○	
FX5U-32MT/ES	○	○	○	○	○	○	○	○	○	○	○	○	
FX5U-32MT/ESS	○	○	○	○	○	○	○	○	○	○	○	○	
FX5U-32MR/DS	○	○	○	○	○	○	○	○	○	○	○	○	
FX5U-32MT/DS	○	□	○	○	○	○	○	○	○	○	○	○	
FX5U-32MT/DSS	○	□	○	○	○	○	○	○	○	○	○	○	
FX5U-64MR/ES	○	○	○	○	○	○	○	○	○	○	○	○	
FX5U-64MT/ES	○	○	○	○	○	○	○	○	○	○	○	○	
FX5U-64MT/ESS	○	○	○	○	○	○	○	○	○	○	○	○	
FX5U-64MR/DS	○	○	○	○	○	○	○	○	○	○	○	○	
FX5U-64MT/DS	○	□	○	○	○	○	○	○	○	○	○	○	
FX5U-64MT/DSS	○	□	○	○	○	○	○	○	○	○	○	○	
FX5U-80MR/ES	○	○	○	○	○	○	○	○	○	○	○	○	
FX5U-80MT/ES	○	○	○	○	○	○	○	○	○	○	○	○	
FX5U-80MT/ESS	○	○	○	○	○	○	○	○	○	○	○	○	
FX5U-80MR/DS	○	○	○	○	○	○	○	○	○	○	○	○	
FX5U-80MT/DS	○	□	○	○	○	○	○	○	○	○	○	○	
FX5U-80MT/DSS	○	□	○	○	○	○	○	○	○	○	○	○	
◆FX5UC CPU modules													
FX5UC-32MR/DS-TS	○	○	○	○	○	○	○	○	○	○	—	○	—
FX5UC-32MT/D	○	□	○	○	○	○	○	○	○	○	○	○	○
FX5UC-32MT/DS-TS	○	□	○	○	○	○	○	○	○	○	○	○	○
FX5UC-32MT/DSS	○	□	○	○	○	○	○	○	○	○	○	○	○
FX5UC-32MT/DSS-TS	○	□	○	○	○	○	○	○	○	○	○	○	○
FX5UC-64MT/D	○	□	○	○	○	○	○	○	○	○	○	○	○
FX5UC-64MT/DSS	○	□	○	○	○	○	○	○	○	○	○	○	○
FX5UC-96MT/D	○	□	○	○	○	○	○	○	○	○	○	○	○
FX5UC-96MT/DSS	○	□	○	○	○	○	○	○	○	○	○	○	○
◆FX5 I/O modules (terminal block type)													
FX5-8EX/ES	○	□	○	○	○	○	○	○	○	○	○	○	○
FX5-8EYR/ES	○	○	○	○	○	○	○	○	○	○	○	○	○
FX5-8EYT/ES	○	□	○	○	○	○	○	○	○	○	○	○	○
FX5-8EYT/ESS	○	□	○	○	○	○	○	○	○	○	○	○	○
FX5-16EX/ES	○	□	○	○	○	○	○	○	○	○	○	○	○
FX5-16EYR/ES	○	○	○	○	○	○	○	○	○	○	○	○	○
FX5-16EYT/ES	○	□	○	○	○	○	○	○	○	○	○	○	○
FX5-16EYT/ESS	○	□	○	○	○	○	○	○	○	○	○	○	○
FX5-16ET/ES-H	○	□	○	○	○	○	○	○	○	○	○	○	○
FX5-16ET/ESS-H	○	□	○	○	○	○	○	○	○	○	○	○	○
FX5-16ER/ES	○	○	○	○	○	○	○	○	○	○	○	○	○
FX5-16ET/ES	○	□	○	○	○	○	○	○	○	○	○	○	○
FX5-16ET/ESS	○	□	○	○	○	○	○	○	○	○	○	○	○
FX5-32ER/ES	○	○	○	○	○	○	○	○	○	○	○	○	○
FX5-32ET/ES	○	○	○	○	○	○	○	○	○	○	○	○	○
FX5-32ET/ESS	○	○	○	○	○	○	○	○	○	○	○	○	○
FX5-32ER/DS	○	○	○	○	○	○	○	○	○	○	○	○	○
FX5-32ET/DS	○	□	○	○	○	○	○	○	○	○	○	○	○
FX5-32ET/DSS	○	□	○	○	○	○	○	○	○	○	○	○	○
◆FX5 safety extension module													
FX5-SF-MU4T5*3	○	□	○	○	○	—	—	—	—	—	—	—	—
FX5-SF-8D14*3	○	□	○	○	○	—	—	—	—	—	—	—	—

Model	CE			UL cUL	KC	Ship approvals							
	EMC	LVD	RoHS			ABS	DNV	LR	BV	RINA	NK	KR	
◆FX5 I/O modules (connector type)													
FX5-C16EX/D	○	□	○	○	○	○	○	○	○	○	○	○	○
FX5-C16EX/DS	○	□	○	○	○	○	○	○	○	○	○	○	○
FX5-C16EYT/D	○	□	○	○	○	○	○	○	○	○	○	○	○
FX5-C16EYT/DSS	○	□	○	○	○	○	○	○	○	○	○	○	○
FX5-C16EYR/D-TS	○	○	○	○	○	○	○	○	○	○	—	○	—
FX5-C32EX/D	○	□	○	○	○	○	○	○	○	○	○	○	○
FX5-C32EX/DS	○	□	○	○	○	○	○	○	○	○	○	○	○
FX5-C32EX/DS-TS	○	□	○	○	○	○	○	○	○	○	○	○	○
FX5-C32EYT/D	○	□	○	○	○	○	○	○	○	○	○	○	○
FX5-C32EYT/D-TS	○	□	○	○	○	○	○	○	○	○	○	○	○
FX5-C32EYT/DSS	○	□	○	○	○	○	○	○	○	○	○	○	○
FX5-C32EYT/DSS-TS	○	□	○	○	○	○	○	○	○	○	○	○	○
FX5-C32ET/D	○	□	○	○	○	○	○	○	○	○	○	○	○
FX5-C32ET/DS-TS	○	□	○	○	○	○	○	○	○	○	○	○	○
FX5-C32ET/DSS	○	□	○	○	○	○	○	○	○	○	○	○	○
FX5-C32ET/DSS-TS	○	□	○	○	○	○	○	○	○	○	○	○	○
◆FX5 intelligent function module													
FX5-4AD	○	□	○	○	○	○	○	○	○	○	—	○	—
FX5-4DA	○	□	○	○	○	○	○	○	○	○	—	○	—
FX5-8AD	○	□	○	○	○	○	○	○	○	○	○	○	○
FX5-4LC	○	□	○	○	○	—	—	—	—	—	—	—	—
FX5-20PG-P	○	□	○	○	○	—	—	—	—	—	—	—	—
FX5-20PG-D	○	□	○	○	○	—	—	—	—	—	—	—	—
FX5-40SSC-S	○	□	○	○	○	—	—	—	—	—	—	—	—
FX5-80SSC-S	○	□	○	○	○	—	—	—	—	—	—	—	—
FX5-40SSC-G	○	□	○	○	○	—	—	—	—	—	—	—	—
FX5-80SSC-G	○	□	○	○	○	—	—	—	—	—	—	—	—
FX5-ENET	○	□	○	○	○	○	○	○	○	○	—	○	—
FX5-ENET/IP	○	□	○	○	○	○	○	○	○	○	—	○	—
FX5-CCLGN-MS	○	□	○	○	○	—	—	—	—	—	—	—	—
FX5-CCL-MS	○	□	○	○*	○	○	○	○	○	○	—	○	—
FX5-CCLIEF	○	□	○	○	○	—	—	—	—	—	—	—	—
FX5-ASL-M	○	□	○	○	○	—	—	—	—	—	—	—	—
FX5-DP-M	○	□	○	○	○	○	○	○	○	○	—	○	—
FX5-OPC	○	□	○	○	○	—	—	—	—	—	—	—	—
◆FX5 extension power supply module													
FX5-1PSU-5V	○	○	○	○	○	○	○	○	○	○	○	○	○
FX5-C1PS-5V	○	□	○	○	○	○	○	○	○	○	○	○	○
◆FX5 bus conversion module													
FX5-CNV-BUS	○	□	○	○	○	○	○	○	○	○	○	○	○
FX5-CNV-BUSC	○	□	○	○	○	○	○	○	○	○	○	○	○
◆FX5 connector conversion module													
FX5-CNV-IF	○	□	○	○	○	○	○	○	○	○	○	○	○
FX5-CNV-IFC	○	□	○	○	○	○	○	○	○	○	○	○	○
◆FX5 connector conversion adapter													
FX5-CNV-BC	○	□	○	—	○	○	○	○	○	○	○	○	○
◆FX5 extended extension cable													
FX5-30EC	□	□	○	—	□	—	—	—	—	—	—	—	—
FX5-65EC	□	□	○	—	□	—	—	—	—	—	—	—	—
◆FX5 expansion adapter													
FX5-232ADP	○	□	○	○	○	○	○	○	○	○	○	○	○
FX5-485ADP	○	□	○	○	○	○	○	○	○	○	○	○	○
FX5-4A-ADP	○	□	○	○	○	—	—	—	—	—	—	—	—
FX5-4AD-ADP	○	□	○	○	○	○	○	○	○	○	○	○	○
FX5-4AD-PT-ADP	○	□	○	○	○	○	○	○	○	○	○	○	○
FX5-4AD-TC-ADP	○	□	○	○	○	○	○	○	○	○	○	○	○
FX5-4DA-ADP	○	□	○	○*	○	○	○	○	○	○	○	○	○
◆FX5U expansion board													
FX5-232-BD	○	□	○	—	○	○	○	○	○	○	○	○	○
FX5-485-BD	○	□	○	—									

# Performance Specifications

**FX5S**

## ◇ FX5S CPU module performance specifications

Item		Specification
Control system		Stored-program repetitive operation
Input/output control system		Refresh system (Direct access input/output allowed by specification of direct access input/output [DX, DY])
Programming specifications	Programming language	Ladder diagram (LD), structured text (ST), function block diagram/ladder diagram (FBD/LD)
	Programming expansion function	Function block (FB), function (FUN), label programming (local/global)
	Constant scan	0.5 to 2000 ms (can be set in 0.1 ms increments)
	Fixed cycle interrupt	1 to 60000 ms (can be set in 1 ms increments)
	Timer performance specifications	100 ms, 10 ms, 1 ms
	No. of program executions	32
Operation specifications	No. of FB files	16 (Up to 15 for user)
	Execution type	Standby type, initial execution type, scan execution type, fixed-cycle execution type, event execution type
Command processing time	Interrupt type	Internal timer interrupt, input interruption, high-speed comparison match interrupt
	LD X0	84 ns
Memory capacity	MOV D0 D1	100 ns
	Program capacity	48 k steps (96 kbytes, flash memory)
	SD memory card	Memory card capacity (SD/SDHC memory card: Max. 16 Gbytes)
	Device/label memory	120 kbytes
Flash memory (Flash ROM) write count		5 Mbytes
Flash memory (Flash ROM) write count		Maximum 20000 times
File storage capacity	Device/label memory	1
	Data memory P: No. of program files FB: FB: No. of FB files	P: 32, FB: 16
	SD memory card	NZ1MEM-2GBSD: 511*1 NZ1MEM-4GBSD, NZ1MEM-8GBSD, NZ1MEM-16GBSD: 65534*1
Clock function	Display data	Year, month, day, hour, minute, second, day of week (leap year automatic detection)
	Precision	Differences per month ±45 sec./25°C (TYP)
No. of input/output points		60 points or less
Power failure retention (clock data*2)	Retention method	Large-capacity capacitor
	Retention time	15 days (Ambient temperature: 25°C)
Power failure retention (device)		Maximum 5k words

\*1: The value listed above indicates the number of files stored in the root folder.

\*2: Clock data is retained using the power accumulated in a large-capacity capacitor incorporated into the PLC. When voltage of the large-capacity capacitor drops, clock data is no longer accurately retained. The retention period of a fully charged capacitor (electricity is conducted across the PLC for at least 30 minutes) is 15 days (ambient temperature: 25°C). How long the capacitor can hold the data depends on the operating ambient temperature. When the operating ambient temperature is high, the holding period is short.

## ◇ Number of device points

Item		Base	Max. number of points	
No. of user device points	Input relay (X)	8	1024 points or less	
	Output relay (Y)	8	1024 points or less	
	Internal relay (M)	10	32768 points (can be changed with a parameter)*1	
	Latch relay (L)	10	32768 points (can be changed with a parameter)*1	
	Link relay (B)	16	32768 points (can be changed with a parameter)*1	
	Annunciator (F)	10	32768 points (can be changed with a parameter)*1	
	Link special relay (SB)	16	32768 points (can be changed with a parameter)*1	
	Step relay (S)	10	4096 points (fixed)	
	Timer system	Timer (T)	10	1024 points (can be changed with a parameter)*1
		Accumulation timer system	Accumulation timer (ST)	10
	Counter system	Counter (C)	10	1024 points (can be changed with a parameter)*1
		Long counter (LC)	10	1024 points (can be changed with a parameter)*1
	Data register (D)		10	8000 points (can be changed with a parameter)*1
	Link register (W)		16	32768 points (can be changed with a parameter)*1
	Link special register (SW)		16	32768 points (can be changed with a parameter)*1
No. of system device points	Special relay (SM)	10	10000 points (fixed)	
	Special register (SD)	10	12000 points (fixed)	
No. of index register points	Index register (Z)*2	10	24 points	
	Long index register (LZ)*2	10	12 points	
No. of file register points	File register (R)	10	32768 points (can be changed with a parameter)*1	
	Extended file register (ER)	10	32768 points (are stored in SD memory card)	
No. of nesting points	Nesting (N)	10	15 points (fixed)	
	Pointer (P)	10	4096 points	
No. of pointer points	Interrupt pointer (I)	10	32 points	
	Others	Decimal constant (K)	Signed	16 bits: -32768 to +32767, 32 bits: -2147483648 to +2147483647
Unsigned			16 bits: 0 to 65535, 32 bits: 0 to 4294967295	
Hexadecimal constant (H)			16 bits: 0 to FFFF, 32 bits: 0 to FFFFFFFF	
Real constant (E)		Single precision	E-3.40282347+38 to E-1.17549435-38, 0, E1.17549435-38 to E3.40282347+38	
Character string			Shift-JIS code max. 255 single-byte characters (256 including NULL) Unicode max. 255 characters (256 including NULL)	

\*1: Can be changed with parameters within the capacity range of the CPU built-in memory.

\*2: The sum of index register (Z) and long index register (LZ) is 24 words.

# Performance Specifications



## FX5UJ

### ◇ FX5UJ CPU module performance specifications

Items		Specifications
Control system		Stored-program repetitive operation
Input/output control system		Refresh system (Direct access input/output allowed by specification of direct access input/output (DX, DY))
Programming specifications	Programming language	Ladder diagram (LD), structured text (ST), function block diagram/ladder diagram (FBD/LD)
	Programming expansion function	Function block (FB), function (FUN), label programming (local/global)
	Constant scan	0.5 to 2000 ms (can be set in 0.1 ms increments)
	Fixed cycle interrupt	1 to 60000 ms (can be set in 1 ms increments)
	Timer performance specifications	100 ms, 10 ms, 1 ms
	No. of program executions	32
Operation specifications	No. of FB files	16 (Up to 15 for user)
	Execution type	Standby type, initial execution type, scan execution type, event execution type
	Interrupt type	Internal timer interrupt, input interruption, high-speed comparison match interrupt, interrupt by modules*1
Command processing time	LD X0	34 ns
	MOV D0 D1	34 ns
Memory capacity	Program capacity	48 k steps (96 kbytes, flash memory)
	SD memory card	Memory card capacity (SD/SDHC memory card: Max. 16 Gbytes)
	Device/label memory	120 kbytes
	Data memory/standard ROM	5 Mbytes
Flash memory (Flash ROM) write count		Maximum 20000 times
File storage capacity	Device/label memory	1
	Data memory	
	P: No. of program files FB: No. of FB files	P: 32, FB: 16
	SD memory card	NZ1MEM-2GBSD: 511*2 NZ1MEM-4GBSD, NZ1MEM-8GBSD, NZ1MEM-16GBSD: 65534*2
Clock function	Display data	Year, month, day, hour, minute, second, day of week (leap year automatic detection)
	Precision	Differences per month ±45 sec./25°C (TYP)
No. of input/output points	(1) No. of input/output points	256 points or less
	(2) No. of remote I/O points	256 points or less
	Total No. of points of (1) and (2)	256 points or less
Power failure retention (clock data*3)	Retention method	Large-capacity capacitor
	Retention time	15 days (Ambient temperature: 25°C)
Power failure retention (device)	Power failure retention capacity	Maximum 12 k word

\*1: Interrupt from the intelligent function module and high-speed pulse input/output module.

\*2: The value listed above indicates the number of files stored in the root folder.

\*3: Clock data is retained using the power accumulated in a large-capacity capacitor incorporated into the PLC. When voltage of the large-capacity capacitor drops, clock data is no longer accurately retained. The retention period of a fully charged capacitor (electricity is conducted across the PLC for at least 30 minutes) is 15 days (ambient temperature: 25°C). How long the capacitor can hold the data depends on the operating ambient temperature. When the operating ambient temperature is high, the holding period is short.

### ◇ Number of device points

Items		Base	Max. number of points*1	
No. of user device points	Input relay (X)	8	1024 points	
	Output relay (Y)	8	1024 points	
	Internal relay (M)	10	7680 points	
	Latch relay (L)	10	7680 points	
	Link relay (B)	16	2048 points	
	Annunciator (F)	10	128 points	
	Link special relay (SB)	16	2048 points	
	Step relay (S)	10	4096 points	
	Timer system	Timer (T)	10	512 points
		Accumulation timer system	10	16 points
	Counter system	Counter (C)	10	256 points
		Long counter (LC)	10	64 points
	Data register (D)	10	8000 points	
	Link register (W)	16	1024 points	
	Link special register (SW)	16	1024 points	
No. of system device points	Special relay (SM)	10	10000 points	
	Special register (SD)	10	12000 points	
Module access device	Intelligent function module device	10	Depends on the intelligent function module.	
No. of index register points	Index register (Z)	10	20 points	
	Long index register (LZ)	10	2 points	
No. of file register points	File register (R)	10	32768 points	
	Extended file register (ER)	10	32768 points (are stored in SD memory card)	
No. of nesting points	Nesting (N)	10	15 points	
No. of pointer points	Pointer (P)	10	2048 points	
	Interrupt pointer (I)	10	178 points	
Others	Decimal constant (K)	Signed	16 bits: -32768 to +32767, 32 bits: -2147483648 to +2147483647	
		Unsigned	16 bits: 0 to 65535, 32 bits: 0 to 4294967295	
	Hexadecimal constant (H)	—	16 bits: 0 to FFFF, 32 bits: 0 to FFFFFFFF	
	Real constant (E)	Single precision	—	E-3.40282347+38 to E-1.17549435-38, 0, E1.17549435-38 to E3.40282347+38
	Character string	—	—	Shift-JIS code max. 255 single-byte characters (256 including NULL) Unicode max. 255 characters (256 including NULL)*2

\*1: Maximum number of points cannot be changed. (fixed)

\*2: Supported in the FX5UJ CPU module firmware version 1.030 or later. In addition, GX Works3 version 1.085P or later is required.



## Performance Specifications



**FX5U** **FX5UC**

### ◇ FX5U/FX5UC CPU module performance specifications

Items		Specifications
Control system		Stored-program repetitive operation
Input/output control system		Refresh system (Direct access input/output allowed by specification of direct access input/output (DX, DY))
Programming specifications	Programming language	Ladder diagram (LD), structured text (ST), function block diagram/ladder diagram (FBD/LD), sequential function chart (SFC)*1
	Programming expansion function	Function block (FB), function (FUN), label programming (local/global)
	Constant scan	0.2 to 2000 ms (can be set in 0.1 ms increments)
	Fixed cycle interrupt	1 to 60000 ms (can be set in 1 ms increments)
	Timer performance specifications	100 ms, 10 ms, 1 ms
Operation specifications	No. of program executions	32
	No. of FB files	16 (Up to 15 for user)
	Execution type	Standby type, initial execution type, scan execution type, fixed-cycle execution type, event execution type
Command processing time	Interrupt type	Internal timer interrupt, input interruption, high-speed comparison match interrupt, interrupt by module*2
	LD X0	34 ns*3
Memory capacity	MOV D0 D1	34 ns*3
	Program capacity	64 k/128 k steps*4 (128 kbytes/256 kbytes, flash memory)
	SD memory card	Memory card capacity (SD/SDHC memory card: Max. 16 Gbytes)
	Device/label memory	150 kbytes*5
Flash memory (Flash ROM) write count	Data memory/standard ROM	5 Mbytes
		Maximum 20000 times
File storage capacity	Device/label memory	1
	Data memory	
	P: No. of program files FB: No. of FB files	P: 32, FB: 16
	SD memory card	NZ1MEM-2GBSD: 511*6 NZ1MEM-4GBSD, NZ1MEM-8GBSD, NZ1MEM-16GBSD: 65534*6
Clock function	Display data	Year, month, day, hour, minute, second, day of week (leap year automatic detection)
	Precision	Differences per month ±45 sec./25°C (TYP)
No. of input/output points	(1) No. of input/output points	256 points or less/384 points or less*4
	(2) No. of remote I/O points	384 points or less/512 points or less*4
	Total No. of points of (1) and (2)	512 points or less
Power failure retention (clock data*7)	Retention method	Large-capacity capacitor
	Retention time	10 days (Ambient temperature: 25°C)
Power failure retention (device)	Power failure retention capacity	Maximum 12 k word*8

\*1: Supported in the FX5U/FX5UC CPU module firmware version 1.220 or later. In addition, GX Works3 version 1.070Y or later is required.

\*2: Interrupt from the intelligent function module and high-speed pulse input/output module.

\*3: When the program capacity is 64 k steps.

\*4: Supported in the FX5U/FX5UC CPU module firmware version 1.100 or later. In addition, GX Works3 version 1.047Z or later is required.

\*5: Supported in the FX5U/FX5UC CPU module firmware version 1.210 or later. In addition, GX Works3 version 1.065T or later is required.

\*6: The value listed above indicates the number of files stored in the root folder.

\*7: Clock data is retained using the power accumulated in a large-capacity capacitor incorporated into the PLC. When voltage of the large-capacity capacitor drops, clock data is no longer accurately retained. The retention period of a fully charged capacitor (electricity is conducted across the PLC for at least 30 minutes) is 10 days (ambient temperature: 25°C). How long the capacitor can hold the data depends on the operating ambient temperature. When the operating ambient temperature is high, the holding period is short.

\*8: All devices in the device (high-speed) area can be held against power failure. Devices in the device (standard) area can be held also when the optional battery is mounted.

### ◇ Number of device points

Items		Base	Max. number of points		
No. of user device points	Input relay (X)	8	1024 points	The total number of X and Y assigned to input/output points is up to 256 points/384 points*1.	
	Output relay (Y)	8	1024 points		
	Internal relay (M)	10	32768 points (can be changed with parameter)*2		
	Latch relay (L)	10	32768 points (can be changed with parameter)*2		
	Link relay (B)	16	32768 points (can be changed with parameter)*2		
	Annunciator (F)	10	32768 points (can be changed with parameter)*2		
	Link special relay (SB)	16	32768 points (can be changed with parameter)*2		
	Step relay (S)	10	4096 points (fixed)		
	Timer system	Timer (T)	10	1024 points (can be changed with parameter)*2	
		Accumulation timer system	10	1024 points (can be changed with parameter)*2	
	Counter system	Counter (C)	10	1024 points (can be changed with parameter)*2	
		Long counter (LC)	10	1024 points (can be changed with parameter)*2	
	Data register (D)	10	8000 points (can be changed with parameter)*2		
	Link register (W)	16	32768 points (can be changed with parameter)*2		
Link special register (SW)	16	32768 points (can be changed with parameter)*2			
No. of system device points	Special relay (SM)	10	10000 points (fixed)		
	Special register (SD)	10	12000 points (fixed)		
Module access device	Intelligent function module device	10	65536 points (designated by U□/G□)		
No. of index register points	Index register (Z)*3	10	24 points		
	Long index register (LZ)*3	10	12 points		
No. of file register points	File register (R)	10	32768 points (can be changed with parameter)*2		
	Extended file register (ER)	10	32768 points (are stored in SD memory card)		
No. of nesting points	Nesting (N)	10	15 points (fixed)		
	Pointer (P)	10	4096 points		
No. of pointer points	Interrupt pointer (I)	10	178 points (fixed)		
	SFC block device (BL)	10	32 points		
No. of SFC points	SFC transition device (TR)	10	0 points (Used only as device comments.)		
	Others	Decimal constant (K)	Signed	16 bits: -32768 to +32767, 32 bits: -2147483648 to +2147483647	
Unsigned			16 bits: 0 to 65535, 32 bits: 0 to 4294967295		
Hexadecimal constant (H)		16 bits: 0 to FFFF, 32 bits: 0 to FFFFFFFF			
Real constant (E)		Single precision	E-3.40282347+38 to E-1.17549435-38, 0, E1.17549435-38 to E3.40282347+38		
Character string		Shift-JIS code max. 255 single-byte characters (256 including NULL) Unicode max. 255 characters (256 including NULL)*4			

\*1: Supported in the FX5U/FX5UC CPU module firmware version 1.100 or later. In addition, GX Works3 version 1.047Z or later is required.

\*2: Can be changed with parameters within the capacity range of the CPU built-in memory.

\*3: The sum of index register (Z) and long index register (LZ) is 24 words.

\*4: Supported in the FX5U/FX5UC CPU module firmware version 1.240 or later. In addition, GX Works3 version 1.075D or later is required.

# List of Instructions

## ◇ CPU module application instruction

Classification	Instruction symbol	Function	Compatible CPU module			
			FX5S	FX5UJ	FX6U	FX6UC
Rotation	ROR(P)	16-bit data right rotation	○	○	○	○
	RCR(P)	Right rotation with 16-bit data carry	○	○	○	○
	ROL(P)	16-bit data left rotation	○	○	○	○
	RLC(P)	Left rotation with 16-bit data carry	○	○	○	○
	DROR(P)	32-bit data right rotation	○	○	○	○
	DRCR(P)	Right rotation with 32-bit data carry	○	○	○	○
	DRCL(P)	32-bit data left rotation	○	○	○	○
Program branch	CJ(P)	Pointer branch	○	○	○	○
	GOEND	Jump to END	○	○	○	○
Program execution control	DI	Interrupt disable	○	○	○	○
	EI	Interrupt enable	○	○	○	○
	DI	Interrupt disable when lower than specified priority	○	○	○	○
	IMASK	Interrupt program mask	○	○	○	○
	SIMASK	Specified interrupt pointer disable/enable	○	○	○	○
	IRET	Return from interrupt program	○	○	○	○
	WDT(P)	WDT reset	○	○	○	○
Structured instruction	FOR	Executed (n) times between ROM instruction and NEXT instruction	○	○	○	○
	NEXT		○	○	○	○
	BREAK(P)	FOR to NEXT forced end	○	○	○	○
	CALL(P)	Subroutine program call	○	○	○	○
	RET	Return from subroutine program	○	○	○	○
	SRET		○	○	○	○
Data table operation	XCALL	Subroutine program call	○	○	○	○
	SFRD(P)	First-in data read from data table	○	○	○	○
	POP(P)	Last-in data read from data table	○	○	○	○
	SFWR(P)	Data write to data table	○	○	○	○
	FINS(P)	Data insertion to data table	○	○	○	○
Reading/writing data	FDEL(P)	Data delete from data table	○	○	○	○
	S(P),DEVLD	Reading data from the data memory	—	○	○	○
File operation instructions	SPDEVST	Writing data to the data memory	—	○	○	○
	SPFREAD	Reading data from the specified file	○	○	○	○
Extended file register operation instruction	SPFWRITE	Writing data to the specified file	○	○	○	○
	SPFDELETE	Deleting the specified file	○	○	○	○
	SPFCOPY	Copying the specified file	○	○	○	○
	SPFMOVE	Moving the specified file	○	○	○	○
	SPFRENAME	Renaming the specified file	○	○	○	○
	SPFSTATUS	Acquiring the status of the specified file	○	○	○	○
	ERREAD	Reading extended file register	○	○	○	○
Character string processing	ERWRITE	Writing extended file register	○	○	○	○
	ERINIT	Batch initialization function of extended file register	○	○	○	○
	LD\$=	Character string comparison LD (S1) = (S2)	○	○	○	○
LD\$<>	Character string comparison LD (S1) <> (S2)	○	○	○	○	
LD\$>	Character string comparison LD (S1) > (S2)	○	○	○	○	
LD\$<=	Character string comparison LD (S1) <= (S2)	○	○	○	○	
LD\$<	Character string comparison LD (S1) < (S2)	○	○	○	○	
LD\$>=	Character string comparison LD (S1) >= (S2)	○	○	○	○	
AND\$=	Character string comparison AND (S1) = (S2)	○	○	○	○	
AND\$<>	Character string comparison AND (S1) <> (S2)	○	○	○	○	
AND\$>	Character string comparison AND (S1) > (S2)	○	○	○	○	
AND\$<=	Character string comparison AND (S1) <= (S2)	○	○	○	○	
AND\$<	Character string comparison AND (S1) < (S2)	○	○	○	○	
AND\$>=	Character string comparison AND (S1) >= (S2)	○	○	○	○	
OR\$=	Character string comparison OR (S1) = (S2)	○	○	○	○	
OR\$<>	Character string comparison OR (S1) <> (S2)	○	○	○	○	
OR\$>	Character string comparison OR (S1) > (S2)	○	○	○	○	
OR\$<=	Character string comparison OR (S1) <= (S2)	○	○	○	○	
OR\$<	Character string comparison OR (S1) < (S2)	○	○	○	○	
OR\$>=	Character string comparison OR (S1) >= (S2)	○	○	○	○	
\$+(P)	Combination of character strings	○	○	○	○	
\$MOV(P)	Transfer of character string	○	○	○	○	
\$MOV(P)_WS	Transferring Unicode string data	○	○	○	○	
BINDA(P)_LU	BIN 16-bit data → Decimal ASCII conversion	○	○	○	○	
DBINDA(P)_LU	BIN 32-bit data → Decimal ASCII conversion	○	○	○	○	
ASCI(P)	HEX code data → ASCII conversion	○	○	○	○	
STR(P)_LU	BIN 16-bit data → Character string conversion	○	○	○	○	
DSTR(P)_LU	BIN 32-bit data → Character string conversion	○	○	○	○	
ESTR(P)	Single precision actual number → Character string conversion	○	○	○	○	
DESTR(P)		○	○	○	○	
WS2SJIS(P)	Converting Unicode character string to Shift JIS character string	○	○	○	○	

○: Supported, —: Not supported

For sequence instructions and basic instructions, refer to manuals.

Classification	Instruction symbol	Function	Compatible CPU module			
			FX5S	FX5UJ	FX6U	FX6UC
Character string processing	SJIS2WS(P)	Converting shift JIS character string to Unicode character string (without byte order mark)	○	○	○	○
	SJIS2WSB(P)	Converting shift JIS character string to Unicode (with byte order mark)	○	○	○	○
	LEN(P)	Detection of character string length	○	○	○	○
	RIGHT(P)	Extraction from right side of character string	○	○	○	○
	LEFT(P)	Extraction from left side of character string	○	○	○	○
	MIDR(P)	Extraction of any part from the middle of character string	○	○	○	○
	MIDW(P)	Replacement of any part in the middle of character string	○	○	○	○
	INSTR(P)	Character string search	○	○	○	○
	STRINS(P)	Character string insertion	○	○	○	○
	STRDEL(P)	Character string deletion	○	○	○	○
Actual number	LDE\$=	Single precision actual number comparison LDE (S1) = (S2)	○	○	○	○
	LDE\$<>	Single precision actual number comparison LDE (S1) <> (S2)	○	○	○	○
	LDE\$>	Single precision actual number comparison LDE (S1) > (S2)	○	○	○	○
	LDE\$<=	Single precision actual number comparison LDE (S1) <= (S2)	○	○	○	○
	LDE\$<	Single precision actual number comparison LDE (S1) < (S2)	○	○	○	○
	LDE\$>=	Single precision actual number comparison LDE (S1) >= (S2)	○	○	○	○
	ANDE\$=	Single precision actual number comparison ANDE (S1) = (S2)	○	○	○	○
	ANDE\$<>	Single precision actual number comparison ANDE (S1) <> (S2)	○	○	○	○
	ANDE\$>	Single precision actual number comparison ANDE (S1) > (S2)	○	○	○	○
	ANDE\$<=	Single precision actual number comparison ANDE (S1) <= (S2)	○	○	○	○
	ANDE\$<	Single precision actual number comparison ANDE (S1) < (S2)	○	○	○	○
	ANDE\$>=	Single precision actual number comparison ANDE (S1) >= (S2)	○	○	○	○
	ORE\$=	Single precision actual number comparison ORE (S1) = (S2)	○	○	○	○
	ORE\$<>	Single precision actual number comparison ORE (S1) <> (S2)	○	○	○	○
	ORE\$>	Single precision actual number comparison ORE (S1) > (S2)	○	○	○	○
	ORE\$<=	Single precision actual number comparison ORE (S1) <= (S2)	○	○	○	○
	ORE\$<	Single precision actual number comparison ORE (S1) < (S2)	○	○	○	○
	ORE\$>=	Single precision actual number comparison ORE (S1) >= (S2)	○	○	○	○
	DECM(P)	Single precision actual number comparison	○	○	○	○
	DEZCP(P)	Binary floating point bandwidth comparison	○	○	○	○
E+(P)	Single precision actual number addition	○	○	○	○	
E-(P)	Single precision actual number subtraction	○	○	○	○	
DEADD(P)	Single precision actual number addition	○	○	○	○	
DESUB(P)	Single precision actual number subtraction	○	○	○	○	
E*(P)	Single precision actual number multiplication	○	○	○	○	
E/(P)	Single precision actual number division	○	○	○	○	
DEMUL(P)	Single precision actual number multiplication	○	○	○	○	
DEDIV(P)	Single precision actual number division	○	○	○	○	
INT2FLT(P)	Signed BIN 16-bit data → Single precision actual number conversion	○	○	○	○	
UINT2FLT(P)	Unsigned BIN 16-bit data → Single precision actual number conversion	○	○	○	○	
DINT2FLT(P)	Signed BIN 32-bit data → Single-precision real number conversion	○	○	○	○	
UDINT2FLT(P)	Unsigned BIN 32-bit data → Single precision actual number conversion	○	○	○	○	
EVAL(P)	Character string → Single precision actual number conversion	○	○	○	○	
DEVAL(P)	Single precision actual number conversion	○	○	○	○	
DEBCD(P)	Binary floating point → Decimal floating point conversion	○	○	○	○	
DEBIN(P)	Decimal floating point → Binary floating point conversion	○	○	○	○	
ENEG(P)	Reverse of single precision actual number sign	○	○	○	○	
DENEG(P)		○	○	○	○	
EMOV(P)	Transfer of single precision actual number data	○	○	○	○	
DEMOV(P)		○	○	○	○	
SIN(P)	Single precision actual number SIN operation	○	○	○	○	
DSIN(P)		○	○	○	○	
COS(P)	Single precision actual number COS operation	○	○	○	○	
DCOS(P)		○	○	○	○	



# List of Instructions

Classification	Instruction symbol	Function	Compatible CPU module			
			FX5S	FX5U	FX5U	FX5UC
Actual number	TAN(P)	Single precision actual number TAN operation	○	○	○	○
	DTAN(P)	Single precision accuracy TAN <sup>-1</sup> operation	○	○	○	○
	ASIN(P)	Single precision actual number SIN <sup>-1</sup> operation	○	○	○	○
	DASIN(P)	Single precision accuracy SIN <sup>-1</sup> operation	○	○	○	○
	ACOS(P)	Single precision actual number COS <sup>-1</sup> operation	○	○	○	○
	DACOS(P)	Single precision accuracy COS <sup>-1</sup> operation	○	○	○	○
	ATAN(P)	Single precision actual number TAN <sup>-1</sup> operation	○	○	○	○
	DATAN(P)	Single precision accuracy TAN <sup>-1</sup> operation	○	○	○	○
	RAD(P)	Single precision actual number angle → Radian conversion	○	○	○	○
	DRAD(P)	Single precision accuracy angle → Radian conversion	○	○	○	○
	DEG(P)	Single precision actual number radian → Angle conversion	○	○	○	○
	DDEG(P)	Single precision accuracy radian → Angle conversion	○	○	○	○
	DESQR(P)	Square root of single precision actual number	○	○	○	○
	ESQR(P)	Square root of single precision accuracy actual number	○	○	○	○
	EXP(P)	Index operation of single precision actual number	○	○	○	○
	DEXP(P)	Index operation of single precision accuracy actual number	○	○	○	○
	LOG(P)	Inferior logarithm operation of single precision actual number	○	○	○	○
	DLOGE(P)	Inferior logarithm operation of single precision accuracy actual number	○	○	○	○
	POW(P)	Exponentiation operation of single precision actual number	○	○	○	○
	LOG10(P)	Common logarithm operation of single precision actual number	○	○	○	○
DLOG10(P)	Common logarithm operation of single precision accuracy actual number	○	○	○	○	
EMAX(P)	Search for maximum value of single precision actual number	○	○	○	○	
EMIN(P)	Search for minimum value of single precision actual number	○	○	○	○	
Random number	RND(P)	Random number generation	○	○	○	○
Index register operation	ZPUSH(P)	Collective saving of index register	○	○	○	○
	ZPOP(P)	Collective return of index register	○	○	○	○
	ZPUSH(P)	Selection and saving of index register/long index register	○	○	○	○
	ZPOP(P)	Selection and return of index register/long index register	○	○	○	○
Data control	LIMIT(P/LU)	BIN 16-bit data upper-/lower-limit control	○	○	○	○
	DLIMIT(P/LU)	BIN 32-bit data upper-/lower-limit control	○	○	○	○
	BAND(P/LU)	BIN 16-bit data dead band control	○	○	○	○
	DBAND(P/LU)	BIN 32-bit data dead band control	○	○	○	○
	ZONE(P/LU)	BIN 16-bit data zone control	○	○	○	○
	DZONE(P/LU)	BIN 32-bit data zone control	○	○	○	○
	SCL(P/LU)	BIN 16-bit unit scaling (point-specific coordinate data)	○	○	○	○
	DSCL(P/LU)	BIN 32-bit unit scaling (point-specific coordinate data)	○	○	○	○
SCL2(P/LU)	BIN 16-bit unit scaling (X-/Y-specific coordinate data)	○	○	○	○	
DSCL2(P/LU)	BIN 32-bit unit scaling (X-/Y-specific coordinate data)	○	○	○	○	
Special timer	ITMR	Teaching timer	○	○	○	○
	STMR	Special function timer	○	○	○	○
Special counter	UDCNTF	Signed 32-bit up/down counter	○	○	○	○
Shortcut control	ROTC	Rotary table shortcut control	○	○	○	○
Inclination signal	RAMPF	Control inclination signal	○	○	○	○
Pulse system	SPD	Measurement of BIN 16-bit pulse density	○	○	○	○
	DSPD	Measurement of BIN 32-bit pulse density	○	○	○	○
	PLSY	BIN 16-bit pulse output	○	○	○	○
	DPLSY	BIN 32-bit pulse output	○	○	○	○
	PWM	BIN 16 pulse width modulation	○	○	○	○
	DPWM	BIN 32-bit pulse width modulation	○	○	○	○
Matrix input	MTR	Matrix input	○	○	○	○
Initial state	IST	Initial state	○	○	○	○
Drum sequence	ABSD	BIN 16-bit data absolute method	○	○	○	○
	DABSD	BIN 32-bit data absolute method	○	○	○	○
	INCD	Relative method	○	○	○	○
Check code	CCD(P)	Check code	○	○	○	○
Data processing instruction	SERIMM(P)	Data processing instruction	○	○	○	○
	DSERIMM(P)	32-bit data search	○	○	○	○
	SUM(P)	16-bit data bit check	○	○	○	○
	DSUM(P)	32-bit data bit check	○	○	○	○
	BON(P)	Bit detection of 16-bit data	○	○	○	○
	DBON(P)	Bit detection of 32-bit data	○	○	○	○
	MAX(P/LU)	Search for maximum value of 16-bit data	○	○	○	○
	DMAX(P/LU)	Search for maximum value of 32-bit data	○	○	○	○
	MIN(P/LU)	Search for minimum value of 16-bit data	○	○	○	○
	DMIN(P/LU)	Search for minimum value of 32-bit data	○	○	○	○
	SORTIBL(U)	16-bit data sort	○	○	○	○
	SORTIBL2(U)	16-bit data alignment 2	○	○	○	○
	DSORTIBL2(U)	32-bit data alignment 2	○	○	○	○
	WSUM(P/LU)	16-bit data total value calculation	○	○	○	○

○: Supported, —: Not supported

For sequence instructions and basic instructions, refer to manuals.

Classification	Instruction symbol	Function	Compatible CPU module			
			FX5S	FX5U	FX5U	FX5UC
Data processing instruction	DWSUM(P/LU)	32-bit data total value calculation	○	○	○	○
	MEAN(P/LU)	16-bit data average value calculation	○	○	○	○
	DMEAN(P/LU)	32-bit data average value calculation	○	○	○	○
	SQRT(P)	Calculation of 16-bit square root	○	○	○	○
	DSQRT(P)	Calculation of 32-bit square root	○	○	○	○
	CRC(P)	CRC calculation	○	○	○	○
Indirect address read	ADRSET(P)	Indirect address read	○	○	○	○
For clock	TRD(P)	Clock data read	○	○	○	○
	TWR(P)	Clock data write	○	○	○	○
	TADD(P)	Addition of clock data	○	○	○	○
	TSUB(P)	Subtraction of clock data	○	○	○	○
	HTOS(P)	16-bit data conversion of time data (hour/minute/second → second)	○	○	○	○
	DHTOS(P)	32-bit data conversion of time data (hour/minute/second → second)	○	○	○	○
	STOH(P)	16-bit data conversion of time data (second → hour/minute/second)	○	○	○	○
	DSTOH(P)	32-bit data conversion of time data (second → hour/minute/second)	○	○	○	○
	LDDT\$=	Date comparison LDDT (S1) = (S2)	○	○	○	○
	LDDT\$<>	Date comparison LDDT (S1) <> (S2)	○	○	○	○
	LDDT\$>	Date comparison LDDT (S1) > (S2)	○	○	○	○
	LDDT\$<=	Date comparison LDDT (S1) <= (S2)	○	○	○	○
	LDDT\$<	Date comparison LDDT (S1) < (S2)	○	○	○	○
	LDDT\$>=	Date comparison LDDT (S1) >= (S2)	○	○	○	○
	ANDDT\$=	Date comparison ANDDT (S1) = (S2)	○	○	○	○
	ANDDT\$<>	Date comparison ANDDT (S1) <> (S2)	○	○	○	○
	ANDDT\$>	Date comparison ANDDT (S1) > (S2)	○	○	○	○
	ANDDT\$<=	Date comparison ANDDT (S1) <= (S2)	○	○	○	○
	ANDDT\$<	Date comparison ANDDT (S1) < (S2)	○	○	○	○
	ANDDT\$>=	Date comparison ANDDT (S1) >= (S2)	○	○	○	○
	ORDT\$=	Date comparison ORDT (S1) = (S2)	○	○	○	○
	ORDT\$<>	Date comparison ORDT (S1) <> (S2)	○	○	○	○
	ORDT\$>	Date comparison ORDT (S1) > (S2)	○	○	○	○
	ORDT\$<=	Date comparison ORDT (S1) <= (S2)	○	○	○	○
	ORDT\$<	Date comparison ORDT (S1) < (S2)	○	○	○	○
	ORDT\$>=	Date comparison ORDT (S1) >= (S2)	○	○	○	○
	LDTM\$=	Time comparison LDTM (S1) = (S2)	○	○	○	○
	LDTM\$<>	Time comparison LDTM (S1) <> (S2)	○	○	○	○
	LDTM\$>	Time comparison LDTM (S1) > (S2)	○	○	○	○
	LDTM\$<=	Time comparison LDTM (S1) <= (S2)	○	○	○	○
	LDTM\$<	Time comparison LDTM (S1) < (S2)	○	○	○	○
	LDTM\$>=	Time comparison LDTM (S1) >= (S2)	○	○	○	○
	ANDTM\$=	Time comparison ANDTM (S1) = (S2)	○	○	○	○
	ANDTM\$<>	Time comparison ANDTM (S1) <> (S2)	○	○	○	○
ANDTM\$>	Time comparison ANDTM (S1) > (S2)	○	○	○	○	
ANDTM\$<=	Time comparison ANDTM (S1) <= (S2)	○	○	○	○	
ANDTM\$<	Time comparison ANDTM (S1) < (S2)	○	○	○	○	
ANDTM\$>=	Time comparison ANDTM (S1) >= (S2)	○	○	○	○	
ORTM\$=	Time comparison ORTM (S1) = (S2)	○	○	○	○	
ORTM\$<>	Time comparison ORTM (S1) <> (S2)	○	○	○	○	
ORTM\$>	Time comparison ORTM (S1) > (S2)	○	○	○	○	
ORTM\$<=	Time comparison ORTM (S1) <= (S2)	○	○	○	○	
ORTM\$<	Time comparison ORTM (S1) < (S2)	○	○	○	○	
ORTM\$>=	Time comparison ORTM (S1) >= (S2)	○	○	○	○	
TCMP(P)	Clock data comparison	○	○	○	○	
TZCP(P)	Clock data bandwidth comparison	○	○	○	○	
DUTY	Timing pulse generation	○	○	○	○	
HOURM	Hour meter (BIN 16-bit data)	○	○	○	○	
DHOURM	Hour meter (BIN 32-bit data)	○	○	○	○	
Module access	REF(P)	I/O refresh	○	○	○	○
	RFS(P)	I/O refresh	○	○	○	○
	FROM(P)	Read of 1-word data from other module (16-bit specified)	—	○	○	○
	DFROM(P)	Read of 2-word data from other module (16-bit specified)	—	○	○	○
	TO(P)	Write of 1-word data from other module (16-bit specified)	—	○	○	○
	DTO(P)	Write of 2-word data from other module (16-bit specified)	—	○	○	○
	FROMD(P)	Read of 1-word data from other module (32-bit specified)	—	○	○	○
	DFROMD(P)	Read of 2-word data from other module (32-bit specified)	—	○	○	○
	TOD(P)	Write of 1-word data from other module (32-bit specified)	—	○	○	○
	DTOD(P)	Write of 2-word data from other module (32-bit specified)	—	○	○	○
Logging	LOGTRG	Setting trigger logging	○	○	○	○
	LOGTRGR	Resetting trigger logging	○	○	○	○
Real-time monitor function	RTM	Real-time monitor function	○	○	○	○

# List of Instructions

## ◇ Step ladder instruction

Classification	Instruction symbol	Function	Compatible CPU module			
			FX5S	FX5UJ	FX5U	FX5UC
Step ladder	STL	Start of step ladder	○	○	○	○
	RETSTL	End of step ladder	○	○	○	○

## ◇ Ethernet instruction

Classification	Instruction symbol	Function	Compatible CPU module			
			FX5S	FX5UJ	FX5U	FX5UC
Built-in Ethernet function instruction	SP.SOCOPEN	Connection establishment	○	○	○	○
	SP.SOCCLOSE	Connection disconnection	○	○	○	○
Socket Communication function	SP.SOCCRCV	Read of received data during END processing	○	○	○	○
	SP.SOCSND	Data transmission	○	○	○	○
	SP.SOCCINF	Read of connection information	○	○	○	○
	SP.SOCCDATA	Read of received data of socket communication	○	○	○	○
Communication protocol support function	SPECPRTCL	Execution of registration protocol of communication protocol support function	○	○	○	○
SLMP frame transmission	SP.SLMPSPND	SLMP message transmission to SLMP-compatible device	○	○	○	○
File transfer function	SP.FTPPUT	Sending FTP client files	○	○	○	○
	SP.FTPGET	Retrieving FTP client files	○	○	○	○
Ethernet module	GP.OPEN	Connection establishment	—	○	○	○
	GP.CLOSE	Connection disconnection	—	○	○	○
	GP.SOCCRCV	Read of received data	—	○	○	○
	GP.SOCSND	Data transmission	—	○	○	○

## ◇ PID control instruction

Classification	Instruction symbol	Function	Compatible CPU module			
			FX5S	FX5UJ	FX5U	FX5UC
PID control	PID	PID operation	○	○	○	○

## ◇ SFC program instructions

Classification	Instruction symbol	Function	Compatible CPU module				
			FX5S	FX5UJ	FX5U	FX5UC	
SFC Control Instructions	LD(S□/BLD□S□)	Checking the status of a step	—	—	○	○	
	LDI(S□/BLD□S□)		—	—	○	○	
	AND(S□/BLD□S□)		—	—	○	○	
	ANI(S□/BLD□S□)		—	—	○	○	
	OR(S□/BLD□S□)		—	—	○	○	
	ORI(S□/BLD□S□)		—	—	○	○	
	LD(BLD□)		—	—	○	○	
	LDI(BLD□)	Checking the status of a block	—	—	○	○	
	AND(BLD□)		—	—	○	○	
	ANI(BLD□)		—	—	○	○	
	OR(BLD□)		—	—	○	○	
	ORI(BLD□)		—	—	○	○	
	MOV(P) [KnS□/BLD□KnS□]		Batch-reading the status of steps	—	—	○	○
	DMOV(P) [KnS□/BLD□KnS□]	—		—	○	○	
	BMOV(P) [KnS□/BLD□KnS□]	—		—	○	○	
	SET(BLD□)	Starting a block	—	—	○	○	
	RST(BLD□)	Ending a block	—	—	○	○	
	SET(S□/BLD□S□)	Activating a step	—	—	○	○	
	RST(S□/BLD□S□)	Deactivating a step	—	—	○	○	
	OUT(S□/BLD□S□)	Activating/deactivating a step	—	—	○	○	
	ZRST(P)S□/BLD□S□	Batch-deactivating a step	—	—	○	○	
	SFC Dedicated Instruction	TRAN	Creating a dummy transition condition	—	—	○	○

## ◇ List of module dedicated instructions

Classification	Instruction symbol	Function	Compatible CPU module			
			FX5S	FX5UJ	FX5U	FX5UC
Network Common	GP.READ	Reading data from the PLC of another station	—	○	○	○
	GP.SREAD	Reading data from the PLC of another station (A read notice is issued.)	—	○	○	○
	GP.WRITE	Writing data to the PLC of another station	—	○	○	○
	GP.SWRITE	Writing data to the PLC of another station (A write notice is issued.)	—	○	○	○
	GP.SEND	Transmission of data to the PLC of another station	—	○	○	○
	GP.RECV	Reception of data from the PLC of another station	—	○	○	○
CC-Link IE TSN	G(P).UINI	Own station number/IP address setting	—	—	○	○
	G(P).SLMPSND	Sending an SLMP message	—	—	○	○
CC-Link IE Field Network	G(P).CCPASET	Setting parameters	—	○	○	○
	G(P).UINI	Setting the station number to own station	—	○	○	○
High-speed counter	DHSCS	32-bit data comparison set	○	○	○	○
	DHSCR	32-bit comparison reset	○	○	○	○
	DHSZ	32-bit data bandwidth comparison	○	○	○	○
	HIOEN(P)	Start and stop of 16-bit data high-speed input/output function	○	○	○	○
High-speed transfer of current value	DHIOEN(P)	Start and stop of 32-bit data high-speed input/output function	○	○	○	○
	HCMOV(P)	High-speed transfer of 16-bit data current value	○	○	○	○
External device communication	DHCMOV(P)	High-speed transfer of 32-bit data current value	○	○	○	○
	RS2	Serial data transfer 2	○	○	○	○
Inverter communication	IVCK	Inverter operation monitor	○	○	○	○
	IVDR	Inverter operation control	○	○	○	○
	IVRD	Inverter parameter read	○	○	○	○
	IWR	Inverter parameter write	○	○	○	○
	IVBWR	Inverter parameter batch write	○	○	○	○
	IVMC	Multiple commands of inverter	○	○	○	○
MODBUS	ADPRW	MODBUS data read/write	○	○	○	○
Communication protocol support function	S(P).CPRTCL	Execution of communication protocol registered by engineering tool	○	○	○	○
	Positioning	DSZR	Home position return with 16-bit data dog search	○	○	○
DDSZR		Home position return with 32-bit data dog search	○	○	○	○
DVIT		16-bit data interrupt positioning	○	○	○	○
DDVIT		32-bit data interrupt positioning	○	○	○	○
TBL		Positioning by 1-table operation	○	○	○	○
DRVITBL		Positioning by multiple-table operation	○	○	○	○
DRVMUL		Multiple axis simultaneous drive positioning	○	○	○	○
DABS		32-bit data ABS current value read	○	○	○	○
PLSV		16-bit data variable speed pulse	○	○	○	○
DPLSV		32-bit data variable speed pulse	○	○	○	○
DRVI		16-bit data relative positioning	○	○	○	○
DDRVI		32-bit data relative positioning	○	○	○	○
DRVA		16-bit data absolute positioning	○	○	○	○
DDRVA		32-bit data absolute positioning	○	○	○	○
BFM split read/write	G.ABRST1 G.ABRST2	Absolute position restoration of specified axis	—	○	○	○
	GP.PSTR1 GP.PSTR2	Starting the positioning of specified axis	—	○	○	○
BFM split read/write	GP.TEACH1 GP.TEACH2	Teaching of specified axis	—	○	○	○
	GP.PFWRT	Backing up the module	—	○	○	○
	GP.PINT	Module initialization	—	○	○	○
	RBFM	BFM split read	—	—	○	○
WBFM	BFM split write	—	—	○	○	

○: Supported, —: Not supported

For sequence instructions and basic instructions, refer to manuals.

# Special Devices

Typical special relays and special registers are described below.  
For details, refer to manual.

## List of special relays

### ◇ Diagnostic information

No.	Name	FX5S	FX5UJ	FX5U	FX5UC
SM0	Latest self diagnosis error (including annunciator ON)	○	○	○	○
SM1	Latest self diagnosis error (not including annunciator ON)	○	○	○	○
SM50	Error reset	○	○	○	○
SM51	Battery low latch	—	—	○	○
SM52	Battery low	—	—	○	○
SM53	AC/DC DOWN	—	○	○	○
SM56	Operation error	○	○	○	○
SM61	I/O module verify error	—	○	○	○
SM62	Annunciator	○	○	○	○

### ◇ System information

No.	Name	FX5S	FX5UJ	FX5U	FX5UC
SM203	STOP contact	○	○	○	○
SM204	PAUSE contact	○	○	○	○
SM210	Clock data set request	○	○	○	○
SM211	Clock data set error	○	○	○	○
SM213	Clock data read request	○	○	○	○

### ◇ SFC information

No.	Name	FX5S	FX5UJ	FX5U	FX5UC
SM320	Presence/absence of SFC program	—	—	○	○
SM321	Start/stop SFC program	—	—	○	○
SM322	SFC program startup status	—	—	○	○
SM323	Presence/absence of continuous transition for entire block	—	—	○	○
SM324	Continuous transition prevention flag	—	—	○	○
SM325	Output mode at block stop	—	—	○	○
SM327	Output mode at execution of the END step	—	—	○	○
SM328	Clear processing mode when the sequence reaches the END step	—	—	○	○
SM4301	FX3 compatible transition operation mode setting status	—	—	○	○

### ◇ System clock

No.	Name	FX5S	FX5UJ	FX5U	FX5UC
SM400	Always ON	○	○	○	○
SM401	Always OFF	○	○	○	○
SM402	After RUN, ON for one scan only	○	○	○	○
SM403	After RUN, OFF for one scan only	○	○	○	○
SM409	0.01 sec. clock	○	○	○	○
SM410	0.1 sec. clock	○	○	○	○
SM411	0.2 sec. clock	○	○	○	○
SM412	1 sec. clock	○	○	○	○
SM413	2 sec. clock	○	○	○	○
SM414	2n sec. clock	○	○	○	○
SM415	2n millisecond clock	○	○	○	○

### ◇ Scan information

No.	Name	FX5S	FX5UJ	FX5U	FX5UC
SM522	Scan time clear request	—	○	○	○

### ◇ Instruction related

No.	Name	FX5S	FX5UJ	FX5U	FX5UC
SM699	Dedicated instruction skip flag	○	○	○	○
SM700	Carry flag	○	○	○	○
SM701	Output character count switching	○	○	○	○
SM703	Sort order	○	○	○	○
SM704	Block comparison	○	○	○	○
SM709	DT/TM instruction improper data detection	○	○	○	○
SM753	File being accessed	○	○	○	○

### ◇ For serial communication

No.	Name	FX5S	FX5UJ	FX5U	FX5UC
SM8500	Serial communication error (ch1)	—	—	○	○
SM8560	Data transfer delayed (ch1)	—	—	○	○
SM8561	Data transfer flag (ch1)	—	—	○	○
SM8562	Receive completion flag (ch1)	—	—	○	○
SM8563	Carrier detection flag (ch1)	—	—	○	○
SM8564	Data set ready flag (ch1)	—	—	○	○
SM8565	Time-out check flag (ch1)	—	—	○	○
SM8740	Station No. setting SD latch enabled (ch1)	—	—	○	○
SM8800	MODBUS RTU communication (ch1)	—	—	○	○
SM8801	Retry (ch1)	—	—	○	○
SM8802	Timeout (ch1)	—	—	○	○
SM8861	Host station No. setting SD latch enabled (ch1)	—	—	○	○
SM8920	Inverter communication (ch1)	—	—	○	○
SM8921	IBVWR instruction error (ch1)	—	—	○	○
SM9040	Data communication error (Master station)	○	○	○	○
SM9041	Data communication error (Slave station No.1)	○	○	○	○

### ◇ FX compatible area

No.	Name	FX5S	FX5UJ	FX5U	FX5UC
SM8000	RUN monitor NO contact	○	○	○	○
SM8001	RUN monitor NC contact	○	○	○	○
SM8002	Initial pulse NO contact	○	○	○	○
SM8003	Initial pulse NC contact	○	○	○	○
SM8004	Error occurrence	○	○	○	○
SM8005	Battery voltage low	—	—	○	○
SM8006	Battery error latch	—	—	○	○
SM8007	Momentary power failure	—	○	○	○
SM8008	Power failure detected	—	○	○	○
SM8011	10 msec clock pulse	○	○	○	○
SM8012	100 msec clock pulse	○	○	○	○
SM8013	1 sec clock pulse	○	○	○	○
SM8014	1 min clock pulse	○	○	○	○
SM8015	Clock stop and preset	○	○	○	○
SM8016	Time read display is stopped	○	○	○	○
SM8017	±30 seconds correction	○	○	○	○
SM8019	Real time clock error	○	○	○	○
SM8020	Zero	○	○	○	○
SM8021	Borrow	○	○	○	○
SM8022	Carry	○	○	○	○
SM8023	Real time clock access error	○	○	○	○
SM8026	Operation stop mode with one ramp output instruction	○	○	○	○
SM8029	Completion of instruction execution	○	○	○	○
SM8031	Non-latch memory all clear	○	○	○	○
SM8032	Latch memory all clear	○	○	○	○
SM8033	Memory hold function when RUN → STOP	○	○	○	○
SM8034	All outputs prohibited	○	○	○	○
SM8039	Constant scan mode	○	○	○	○
SM8040	For STL: Transition prohibited	○	○	○	○
SM8041	For STL: Start of operation during automatic operation	○	○	○	○
SM8042	For STL: Start pulse	○	○	○	○
SM8043	For STL: Completion of home position return	○	○	○	○
SM8044	For STL: Home position condition	○	○	○	○
SM8045	For STL: All output reset prohibited during mode switch	○	○	○	○
SM8046	For STL: With STL state ON	○	○	○	○
SM8047	For STL: STL monitor (SD8040 to SD8047) enabled	○	○	○	○
SM8048	Annunciator operation	○	○	○	○
SM8049	ON annunciator minimum number enabled	○	○	○	○
SM8063	Serial communication error1 (ch1)	○	○	○	○
SM8067	Operation error	○	○	○	○
SM8068	Operation error latch	○	○	○	○

○: Supported, —: Not supported

## List of special registers

### ◇ Diagnostic information

No.	Name	FX5S	FX5UJ	FX5U	FX5UC
SD0	Latest self diagnosis error code	○	○	○	○
SD1	Clock time for self diagnosis error occurrence (Year)	○	○	○	○
SD2	Clock time for self diagnosis error occurrence (Month)	○	○	○	○
SD3	Clock time for self diagnosis error occurrence (Day)	○	○	○	○
SD4	Clock time for self diagnosis error occurrence (Hour)	○	○	○	○
SD5	Clock time for self diagnosis error occurrence (Minute)	○	○	○	○
SD6	Clock time for self diagnosis error occurrence (Second)	○	○	○	○
SD7	Clock time for self diagnosis error occurrence (Day Week)	○	○	○	○

### ◇ System information

No.	Name	FX5S	FX5UJ	FX5U	FX5UC
SD203	CPU Status	○	○	○	○
SD210	Clock Data (Year)	○	○	○	○
SD211	Clock Data (Month)	○	○	○	○
SD212	Clock Data (Day)	○	○	○	○
SD213	Clock Data (Hour)	○	○	○	○
SD214	Clock Data (Minute)	○	○	○	○
SD215	Clock Data (Second)	○	○	○	○
SD216	Clock Data (Day Week)	○	○	○	○

### ◇ System clock

No.	Name	FX5S	FX5UJ	FX5U	FX5UC
SD412	One second counter	○	○	○	○
SD414	2n second clock setting	○	○	○	○
SD415	2n ms second clock setting	○	○	○	○
SD420	Scan counter	○	○	○	○

### ◇ Scan information

No.	Name	FX5S	FX5UJ	FX5U	FX5UC
SD518	Initial scan time (ms)	○	○	○	○
SD519	Initial scan time (μs)	○	○	○	○
SD520	Current scan time (ms)	○	○	○	○
SD521	Current scan time (μs)	○	○	○	○
SD522	Minimum scan time (ms)	○	○	○	○
SD523	Minimum scan time (μs)	○	○	○	○
SD524	Maximum scan time (ms)	○	○	○	○
SD525	Maximum scan time (μs)	○	○	○	○
SD526	END processing time (ms)	○	○	○	○
SD527	END processing time (μs)	○	○	○	○
SD528	Constant scan waiting time (ms)	○	○	○	○
SD529	Constant scan waiting time (μs)	○	○	○	○
SD530	Scan program execution time (ms)	○	○	○	○
SD531	Scan program execution time (μs)	○	○	○	○

### ◇ For serial communication

No.	Name	FX5S	FX5UJ	FX5U	FX5UC
SD8500	Serial communication error code (ch1)	—	—	○	○
SD8501	Serial communication error details (ch1)	—	—	○	○
SD8502	Serial communication setting (ch1)	—	—	○	○
SD8503	Serial communication operational mode (ch1)	—	—	○	○

### ◇ For built-in Ethernet

No.	Name	FX5S	FX5UJ	FX5U	FX5UC
SD10050	Local node IP address [low-order]	○	○	○	○
SD10051	Local node IP address [high-order]	○	○	○	○
SD10060	Subnet mask [low-order]	○	○	○	○
SD10061	Subnet mask [high-order]	○	○	○	○
SD10064	Default gateway IP address [low-order]	○	○	○	○
SD10065	Default gateway IP address [high-order]	○	○	○	○
SD10074	Local node MAC address	○	○	○	○
SD10075	Local node MAC address	○	○	○	○
SD10076	Local node MAC address	○	○	○	○
SD10082	Communication speed setting	○	○	○	○
SD10084	MELSOFT connection TCP port No.	○	○	○	○
SD10086	MELSOFT direct connection port No.	○	○	○	○

### ◇ FX compatible area

No.	Name	FX5S	FX5UJ	FX5U	FX5UC
SD8000	Watch dog timer	○	○	○	○
SD8001	PLC type and system version	○	○	○	○
SD8005	Battery voltage	—	—	○	○
SD8006	Low battery voltage	—	—	○	○
SD8007	Power failure count	—	○	○	○
SD8008	Power failure detection period	—	○	○	○
SD8010	Current scan time	○	○	○	○
SD8011	Minimum scan time	○	○	○	○
SD8012	Maximum scan time	○	○	○	○
SD8013	RTC: Seconds	○	○	○	○
SD8014	RTC: Minute data	○	○	○	○
SD8015	RTC: Hour data	○	○	○	○
SD8016	RTC: Day data	○	○	○	○
SD8017	RTC: Month data	○	○	○	○
SD8018	RTC: Year data	○	○	○	○
SD8019	RTC: Day of week data	○	○	○	○
SD8039	Constant scan duration	○	○	○	○
SD8040	ON state number 1	○	○	○	○
SD8041	ON state number 2	○	○	○	○
SD8042	ON state number 3	○	○	○	○
SD8043	ON state number 4	○	○	○	○
SD8044	ON state number 5	○	○	○	○
SD8045	ON state number 6	○	○	○	○
SD8046	ON state number 7	○	○	○	○
SD8047	ON state number 8	○	○	○	○
SD8049	Lowest active Annunciator	○	○	○	○
SD8063	Serial communication error code (ch1)	○	○	○	○
SD8067	Operation error	○	○	○	○

○: Supported, —: Not supported

# General, Power Supply, Input/Output Specifications

## ◇ General specifications

Item	Specifications				
	FX5S/FX5UJ		FX5U/FX5UC		
Operating ambient temperature*1	0 to 55°C (32 to 131°F), non-freezing		-20 to 55°C (-4 to 131°F), non-freezing*2*3*4		
Storage ambient temperature	-25 to 75°C (-13 to 167°F), non-freezing				
Operating ambient humidity	5 to 95%RH, non-condensation*5				
Storage ambient humidity	5 to 95%RH, non-condensation				
Vibration resistance*6*7	Installed on DIN rail	Frequency	Acceleration	Half amplitude	Sweep count 10 times each in X, Y, Z directions (80 min in each direction)
		5 to 8.4 Hz	—	1.75 mm	
	8.4 to 150 Hz	4.9 m/s <sup>2</sup>	—		
	Direct installing*8	Frequency	Acceleration	Half amplitude	
5 to 8.4 Hz	—	—	3.5 mm		
8.4 to 150 Hz	9.8 m/s <sup>2</sup>	—	—		
Shock resistance*6	147 m/s <sup>2</sup> , Action time: 11 ms, 3 times by half-sine pulse in each direction X, Y, and Z				
Noise durability*9	By noise simulator at noise voltage of 1000 Vp-p, noise width of 1 ms and period of 30 to 100 Hz				
Grounding	Class D grounding (grounding resistance: 100 Ω or less) <Common grounding with a heavy electrical system is not allowed.> *10				
Working atmosphere	Free from corrosive or flammable gas and excessive conductive dust				
Operating altitude*11	0 to 2000 m				
Installation location	Inside a control panel*12				
Overvoltage category*13	II or less				
Pollution degree*14	2 or less				

\*1 : The simultaneous ON ratio of available PLC inputs or outputs changes with respect to the ambient temperature. For details, refer to the manual.

\*2 : 0 to 55°C for products manufactured before June 2016. For intelligent function modules, refer to the manual of each product.

The following products cannot be used when the ambient temperature is less than 0°C:

FX5-40SSC-S, FX5-80SSC-S, FX5-CNV-BUS, FX5-CNV-BUSC, battery (FX3U-32BL), SD memory cards (NZ1MEM-2GBSD, NZ1MEM-4GBSD, NZ1MEM-8GBSD, NZ1MEM-16GBSD, L1MEM-2GBSD and L1MEM-4GBSD), FX3 extension modules, terminal blocks and I/O cables (FX-16E-500CAB-S, FX-16E-□CAB and FX-16E-□CAB-R)

\*3 : The specifications are different in the use at less than 0°C. For details, refer to the manual.

\*4 : When using the FX5-CCLGN-MS manufactured in December 2020 or earlier, the operating ambient temperature is -20 to 50°C.

\*5 : When used in a low-temperature environment, use in an environment with no sudden temperature changes. If there are sudden temperature changes because of opening/closing of the control panel or other reasons, condensation may occur, which may cause a fire, fault, or malfunction. Furthermore, use an air conditioner in dehumidifier mode to prevent condensation.

\*6 : The criterion is shown in IEC61131-2.

\*7 : When the system has equipment which specification values are lower than above mentioned vibration resistance specification values, the vibration resistance specification of the whole system is corresponding to the lower specification.

\*8 : Direct installation of FX5UC is not possible.

\*9 : When using the FX5 safety extension modules under the severe noise environment, implement external noise countermeasures with a surge absorber and ferrite core.

\*10 : For grounding, refer to manuals of each product.

\*11 : The PLC cannot be used at a pressure higher than the atmospheric pressure to avoid damage.

\*12 : The programmable controller is assumed to be installed in an environment equivalent to indoor.

\*13 : This indicates the section of the power supply to which the equipment is assumed to be connected between the public electrical power distribution network and the machinery within premises. Category II applies to equipment for which electrical power is supplied from fixed facilities. The surge voltage withstand level for up to the rated voltage of 300 V is 2500 V.

\*14 : This index indicates the degree to which conductive material is generated in the environment in which the equipment is used. Pollution level 2 is when only non-conductive pollution occurs. Temporary conductivity caused by condensation must be expected occasionally.

## ◇ Power supply specifications

### ● Power supply specifications (FX5S CPU module)

Item	Specifications		
	FX5S-30M□	FX5S-40M□	FX5S-60M□
Rated voltage	100 to 240 V AC		
Voltage fluctuation range	-15%, +10%		
Frequency rating	50/60 Hz		
Allowable instantaneous power failure time	Operation can be continued upon occurrence of instantaneous power failure for 10 ms or less.		
Power fuse	250 V, 3.15 A Time-lag fuse		
Rush current	Max. 30 A 5 ms or less/100 V AC Max. 50 A 5 ms or less/200 V AC		
Power consumption*1	28 W	30 W	33 W
24 V DC service power supply capacity*2	Supply capacity when 24 V DC service power supply is used for input circuit of the CPU module	400 mA	
	Supply capacity when external power supply is used for input circuit of the CPU module		

\*1 : The values show the state where the service power of 24 V DC is consumed to the maximum level in case that its configuration has the max. number of connections provided to CPU module. (Including the current in the input circuit)

\*2 : Use as power supply for input devices. (Cannot be used as an external power supply for expansion adapters.)

For the general specifications for each model, refer to each manual.

# General, Power Supply, Input/Output Specifications

## ● Power supply specifications (FX5UJ CPU module)

Item	Specifications			
	FX5UJ-24M□	FX5UJ-40M□	FX5UJ-60M□	
Rated voltage	100 to 240 V AC			
Voltage fluctuation range	-15%, +10%			
Frequency rating	50/60 Hz			
Allowable instantaneous power failure time*1	Operation can be continued upon occurrence of instantaneous power failure for 10 ms or less. When the supply voltage is 200 V AC or higher, the time can be change to 10 to 100 ms by editing the user program.			
Power fuse	250 V, 3.15 A Time-lag fuse			
Rush current	25 A max. 5 ms or less/100 V AC 50 A max. 5 ms or less/200 V AC	30 A max. 5 ms or less/100 V AC 50 A max. 5 ms or less/200 V AC		
Power consumption*2	30 W	32 W	35 W	
24 V DC service power supply capacity*3*4	Supply capacity when 24 V DC service power supply is used for input circuit of the CPU module	400 mA	400 mA	400 mA
	Supply capacity when external power supply is used for input circuit of the CPU module	460 mA	500 mA	550 mA

\*1: The allowable instantaneous power failure time does not apply to the FX5 safety extension module.

\*2: This item shows value when all 24 V DC service power supplies are used in the maximum configuration connectable to the CPU module. (The current of the input circuit is included.)

\*3: When I/O modules are connected, they consume current from the 24 V DC service power supply. For details about the service power supply, refer to the manual.

\*4: The FX5 safety extension module cannot use a 24 V DC service power supply.

## ● Power supply specifications (FX5U CPU module, AC power supply type)

Item	Specifications			
	FX5U-32M□/E□	FX5U-64M□/E□	FX5U-80M□/E□	
Rated voltage	100 to 240 V AC			
Voltage fluctuation range	-15%, +10%			
Frequency rating	50/60 Hz			
Allowable instantaneous power failure time	Operation can be continued upon occurrence of instantaneous power failure for 10 ms or less. If the supply voltage is 200 V AC system, change in the range from 10 to 100 ms can be made by the user program.			
Power fuse	250 V 3.15 A Time-lag Fuse	250 V 5 A Time-lag Fuse		
Rush current	25 A max. 5 ms or less/100 V AC 50 A max. 5 ms or less/200 V AC	30 A max. 5 ms or less/100 V AC 60 A max. 5 ms or less/200 V AC		
Power consumption*1	30 W	40 W	45 W	
5 V DC internal power supply capacity	900 mA	1100 mA	1100 mA	
24 V DC service power supply capacity*2	Supply capacity when 24 V DC service power supply is used for input circuit of the CPU module*3	400 mA (300 mA)	600 mA (300 mA)	600 mA (300 mA)
	Supply capacity when external power supply is used for input circuit of the CPU module*3	480 mA (380 mA)	740 mA (440 mA)	770 mA (470 mA)

\*1: The values show the state where the service power of 24 V DC is consumed to the maximum level in case that its configuration has the max. no. of connections provided to CPU module. (Including the current in an input circuit)

\*2: When I/O modules are connected, they consume current from the 24 V DC service power supply, resulting in decrease of usable current. For details about the service power supply, refer to the manual.

\*3: The value in ( ) is capacity of 24 V DC service power supply in the case where operating ambient temperature is lower than 0°C.

## ● Power supply specifications (FX5U CPU module, DC power supply type)

Item	Specifications		
	FX5U-32M□/D□	FX5U-64M□/D□	FX5U-80M□/D□
Rated voltage	24 V DC		
Voltage fluctuation range	-30%, +20%		
Allowable instantaneous power failure time	Operation can be continued upon occurrence of instantaneous power failure for 5 ms or less.		
Power fuse	250 V 3.15 A Time-lag Fuse	250 V 5 A Time-lag Fuse	
Rush current	50 A max. 0.5 ms or less/24 V DC	65 A max. 2.0 ms or less/24 V DC	
Power consumption*1	30 W	40 W	45 W
5 V DC internal power supply capacity*2	900 mA (775 mA)	1100 mA (975 mA)*2	1100 mA (975 mA)*2
24 V DC internal power supply capacity*2	480 mA (360 mA)	740 mA (530 mA)*2	770 mA (560 mA)*2

\*1: The values show the state where power is consumed to the maximum level in case that the configuration has the max. no. of connections provided to CPU module.

\*2: The values in the parentheses ( ) indicate the power supply capacity to be resulted when the power supply voltage falls in the range from 16.8 to 19.2 V DC.

## ● Power supply specifications (FX5UC CPU module)

Item	Specifications		
	FX5UC-32M□/□	FX5UC-64MT/□	FX5UC-96MT/□
Rated voltage	24 V DC		
Voltage fluctuation range	+20%, -15%		
Allowable instantaneous power failure time	Operation can be continued upon occurrence of instantaneous power failure for 5 ms or less.		
Power fuse	125 V 3.15 A Time-lag Fuse		
Rush current	35 A max. 0.5 ms or less/24 V DC	40 A max. 0.5 ms or less/24 V DC	
Power consumption*	5 W/24 V DC (30 W/24 V DC +20%, -15%)	8 W/24 V DC (33 W/24 V DC +20%, -15%)	11 W/24 V DC (36 W/24 V DC +20%, -15%)
5 V DC internal power supply capacity	720 mA		
24 V DC internal power supply capacity	500 mA		

\*: The value results when the CPU module is used alone.

The values in the parentheses ( ) result when the maximum no. of connections have been made to the CPU module. (External DC 24 V power supplies of extension modules are not included.)

For the general specifications for each model, refer to each manual.



## General, Power Supply, Input/Output Specifications

### ● Power supply specifications (FX5-4A-ADP)

Item	Specifications
External electric supply (Analog conversion circuit)	24 V DC +20%, -15% 100 mA External electric supply is carried out from the power supply connector of an adapter.
Internal electric supply (Interface)	5 V DC 10 mA Internal electric supply is carried out from 5 V DC power supply of a CPU module.

### ● Power supply specifications (FX5-4DA-ADP)

Item	Specifications
External power feed (D/A conversion circuit)	24 V DC +20%, -15% 160 mA Power is externally fed from the power supply connector of the adapter.
Internal power feed (interface)	5 V DC 10 mA Power is internally fed from the 5 V DC power supply of the CPU module.

### ● Power Supply Specifications (FX5-4AD-TC-ADP)

Item	Specifications
Internal power feed (A/D conversion circuit)	24 V DC 20 mA Power is internally fed from 24 V DC power supply of the CPU module.
Internal power feed (interface)	5 V DC 10 mA Power is internally fed from 5 V DC power supply of the CPU module.

### ● Power supply specifications (FX5-4AD-ADP)

Item	Specifications
Internal power feed (A/D conversion circuit)	24 V DC 20 mA Power is internally fed from the 24 V DC power supply of the CPU module.
Internal power feed (interface)	5 V DC 10 mA Power is internally fed from the 5 V DC power supply of the CPU module.



### ● Power Supply Specifications (FX5-4AD-PT-ADP)

Item	Specifications
Internal power feed (A/D conversion circuit)	24 V DC 20 mA Power is internally fed from 24 V DC power supply of the CPU module.
Internal power feed (interface)	5 V DC 10 mA Power is internally fed from 5 V DC power supply of the CPU module.

# General, Power Supply, Input/Output Specifications

## ◇ Input specifications

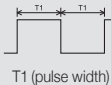
### ● Input specifications (FX5S CPU module)

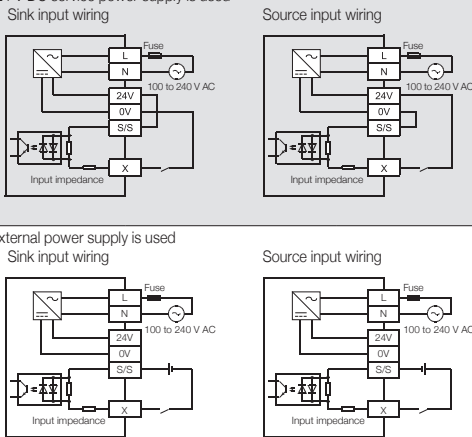

Item	Specifications		
	FX5S-30M□	FX5S-40M□	FX5S-60M□
Number of input points	16 points	24 points	36 points
Connection type	Non-removable terminal block (M3 screws)		
Input type	Sink/source		
Input signal voltage	24 V DC +20%, -15%		
Input signal current	X0 to X7	5.1 mA/24 V DC	
	X10 and subsequent	4.0 mA/24 V DC	
Input impedance	X0 to X7	4.3 kΩ	
	X10 and subsequent	5.6 kΩ	
ON input sensitivity current	X0 to X7	3.5 mA or more	
	X10 and subsequent	3.0 mA or more	
OFF input sensitivity current	1.5 mA or less		
Input response frequency	X0, X1, X3, X4	100 kHz When capturing pulses of a response frequency of 50 to 100 kHz, refer to the manual.	
	X2, X5, X6, X7	10 kHz	
Pulse waveform	Waveform		
	X0, X1, X3, X4	5 μs or more	
	X2, X5, X6, X7	50 μs or more	
	Waveform		
Input response time (H/W filter delay)	X0, X1, X3, X4	ON: 5 μs or less OFF: 5 μs or less	
	X2, X5, X6, X7	ON: 30 μs or less OFF: 50 μs or less	
	X10 to X17	ON: 50 μs or less OFF: 150 μs or less	
	X20 and subsequent	ON: Approx. 10 ms	
		OFF: Approx. 10 ms	
Input response time (Digital filter setting value)	X0 to X17	None, 10 μs, 50 μs, 0.1 ms, 0.2 ms, 0.4 ms, 0.6 ms, 1 ms, 5 ms, 10 ms (initial values), 20 ms, 70 ms When using this product in an environment with much noise, set the digital filter.	
Input signal format	No-voltage contact input Sink: NPN open collector transistor Source: PNP open collector transistor		
Input circuit insulation	Photocoupler		
Indication of input operation	LED is lit when input is on		
Input circuit configuration	AC power supply type	<ul style="list-style-type: none"> <li>When the 24 V DC service power supply is used</li> </ul>	
		<ul style="list-style-type: none"> <li>When an external power supply is used</li> </ul>	



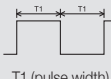

# General, Power Supply, Input/Output Specifications

## ● Input specifications (FX5UJ CPU module)

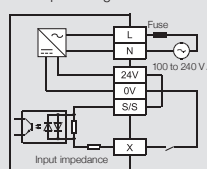
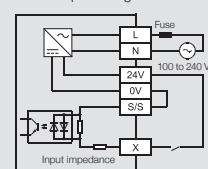
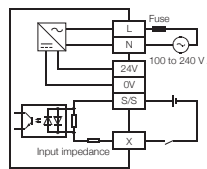
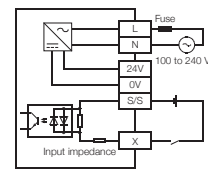
Item	Specifications		
	FX5UJ-24M□	FX5UJ-40M□	FX5UJ-60M□
No. of input points	14 points (16 points)*	24 points	36 points (40 points)*
Connection type	Removable terminal block (M3 screws)		
Input type	Sink/source		
Input signal voltage	24 V DC +20 %, -15%		
Input signal current	X0 to X7	5.3 mA/24 V DC	
	X10 and subsequent	4.0 mA/24 V DC	
Input impedance	X0 to X7	4.3 kΩ	
	X10 and subsequent	5.6 kΩ	
ON input sensitivity current	X0 to X7	3.5 mA or more	
	X10 and subsequent	3.0 mA or more	
OFF input sensitivity current	1.5 mA or less		
Input response frequency	X0, X1, X3, X4	100 kHz When capturing pulses of a response frequency of 50 to 100 kHz, refer to the manual.	
	X2, X5, X6, X7	10 kHz	
Pulse waveform	Waveform	 T1 (pulse width)	
	X0, X1, X3, X4	5 μs or more	
		X2, X5, X6, X7	50 μs or more
	Waveform	 T2 (rise/fall time)	
X0, X1, X3, X4	2.5 μs or less		
Input response time (H/W filter delay)	X0, X1, X3, X4	ON: 5 μs or less OFF: 5 μs or less	
		X2, X5, X6, X7	ON: 30 μs or less OFF: 50 μs or less
	X10 to X17	ON: 50 μs or less OFF: 150 μs or less	
	X20 and subsequent	ON: Approx. 10 ms OFF: Approx. 10 ms	
Input response time (Digital filter setting value)	X0 to X17	None, 10 μs, 50 μs, 0.1 ms, 0.2 ms, 0.4 ms, 0.6 ms, 1 ms, 5 ms, 10 ms (initial values), 20 ms, 70 ms When using this product in an environment with much noise, set the digital filter.	
Input signal format	No-voltage contact input Sink: NPN open collector transistor Source: PNP open collector transistor		
Input circuit insulation	Photocoupler		
Indication of input operation	LED is lit when input is on		
Input circuit configuration	AC power supply type	- When using 24 V DC service power supply Sink input wiring  Source input wiring 	
		- When using external power supply Sink input wiring  Source input wiring 	

\*: The number in parentheses represents occupied points.

# General, Power Supply, Input/Output Specifications

## ● Input specifications (FX5U CPU module)

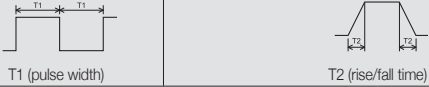
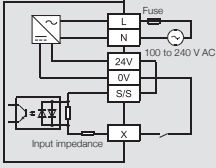
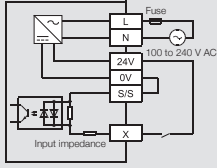
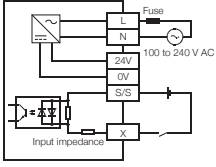
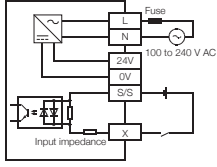
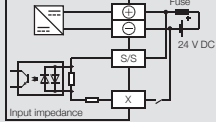
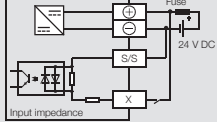
Item	Specifications		
	FX5U-32M□	FX5U-64M□	FX5U-80M□
No. of input points	16 points	32 points	40 points
Connection type	Removable terminal block (M3 screws)		
Input type	Sink/source		
Input signal voltage	24 V DC +20%, -15%		
Input signal current	X0 to X17	5.3 mA/24 V DC	
	X20 and subsequent	4.0 mA/24 V DC	
Input impedance	X0 to X17	4.3 kΩ	
	X20 and subsequent	5.6 kΩ	
ON input sensitive current	X0 to X17	3.5 mA or more	
	X20 and subsequent	3.0 mA or more	
OFF input sensitivity current	1.5 mA or less		
Input response frequency	X0 to X5	200 kHz	—
	X0 to X7	—	200 kHz
	X6 to X17	10 kHz	—
	X10 to X17	—	10 kHz
Pulse waveform	Waveform		
	X0 to X5	T1: 2.5 μs or more, T2: 1.25 μs or less	—
	X0 to X7	—	T1: 2.5 μs or more, T2: 1.25 μs or less
	X6 to X17	T1: 50 μs or more, T2: 25 μs or less	—
	X10 to X17	—	T1: 50 μs or more, T2: 25 μs or less
Input response time (H/W filter delay)	X0 to X5	ON: 2.5 μs or less, OFF: 2.5 μs or less	—
	X0 to X7	—	ON: 2.5 μs or less, OFF: 2.5 μs or less
	X6 to X17	ON: 30 μs or less, OFF: 50 μs or less	—
	X10 to X17	—	ON: 30 μs or less, OFF: 50 μs or less
	X20 and subsequent	—	ON: 50 μs or less, OFF: 150 μs or less
Input response time (Digital filter setting value)	None, 10 μs, 50 μs, 0.1 ms, 0.2 ms, 0.4 ms, 0.6 ms, 1 ms, 5 ms, 10 ms (initial values), 20 ms, 70 ms When using this product in an environment with much noise, set the digital filter.		
Input signal format	No-voltage contact input Sink: NPN open collector transistor Source: PNP open collector transistor		
Input circuit insulation	Photocoupler		
Indication of input operation	LED is lit when input is on		
Input circuit configuration	AC power supply type	- When using 24 V DC service power supply	
		Sink input wiring	Source input wiring
			
	- When using external power supply		
	Sink input wiring	Source input wiring	
			
DC power supply type	Sink input wiring	Source input wiring	
			

# General, Power Supply, Input/Output Specifications

## ● Input specifications (FX5UC CPU module)

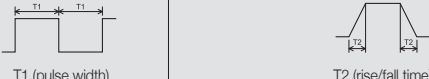
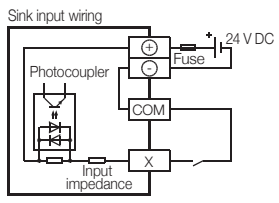
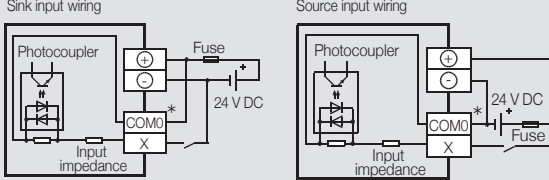
Item	Specifications		
	FX5UC-32M□/□	FX5UC-64MT/□	FX5UC-96MT/□
No. of input points	16 points	32 points	48 points
Connection type	Connector (FX5UC-□MT/D(SS)) Spring clamp terminal block (FX5UC-32M□/□-TS)		
Input type	Sink (FX5UC-□MT/D) Sink/source (FX5UC-□MT/DSS, FX5UC-32MT/DS(S)-TS)		
Input signal voltage	24 V DC +20%, -15%		
Input signal current	X0 to X17	5.3 mA/24 V DC	
	X20 and subsequent	4.0 mA/24 V DC	
Input impedance	X0 to X17	4.3 kΩ	
	X20 and subsequent	5.6 kΩ	
ON input sensitivity current	X0 to X17	3.5 mA or more	
	X20 and subsequent	3.0 mA or more	
OFF input sensitivity current	1.5 mA or less		
Input response frequency	X0 to X5	200 kHz	—
	X0 to X7	—	200 kHz
	X6 to X17	10 kHz	—
	X10 to X17	—	10 kHz
Pulse waveform	Waveform		
	X0 to X5	T1: 2.5 μs or more, T2: 1.25 μs or less	—
	X0 to X7	—	T1: 2.5 μs or more, T2: 1.25 μs or less
	X6 to X17	T1: 50 μs or more, T2: 25 μs or less	—
Input response time (H/W filter delay)	X0 to X5	ON: 2.5 μs or less, OFF: 2.5 μs or less	—
	X0 to X7	—	ON: 2.5 μs or less, OFF: 2.5 μs or less
	X6 to X17	ON: 30 μs or less, OFF: 50 μs or less	—
	X10 to X17	—	ON: 30 μs or less, OFF: 50 μs or less
X20 and subsequent	—	ON: 50 μs or less, OFF: 150 μs or less	
Input response time (Digital filter setting value)	None, 10 μs, 50 μs, 0.1 ms, 0.2 ms, 0.4 ms, 0.6 ms, 1 ms, 5 ms, 10 ms (initial values), 20 ms, 70 ms When using this product in an environment with much noise, set the digital filter.		
Input signal format (Input sensor form)	FX5UC-□MT/D No-voltage contact input NPN open collector transistor FX5UC-□MT/DSS, FX5UC-32M□/□-TS No-voltage contact input Sink: NPN open collector transistor Source: PNP open collector transistor		
Input circuit insulation	Photocoupler		
Indication of input operation	LED is lit when input is on (DISP switch: IN)		
Input circuit configuration	FX5UC-□MT/D 		
	FX5UC-□MT/DSS, FX5UC-32M□/□-TS 		

\*: Spring clamp terminal block type: The [COM0] terminal is the [S/S] terminal.

# General, Power Supply, Input/Output Specifications

## ● Safety inputs specifications (safety main module)

Item		Specifications
		FX5-SF-MU4T5*7
Connection type		Spring clamp terminal block
Number of inputs		4 points
Input voltage (ON)		13 V DC or more (13 V DC to 30 V DC)
Input voltage (OFF)		5 V DC or less (-5 V DC to 5 V DC)
Input current (ON)		3 mA (2.4 mA to 3.8 mA)
Input current (OFF)		2.1 mA or less (-2.5 mA to 2.1 mA)
Input response time (filter delay)		2 ms
Indication of input operation		LED lights when an input is ON.
Minimum switch-off time*1*2 (I0/I1)	Program 1, 2, 4, 5, 6, and 9	24 ms
	Program 3.1, 7, and 8	4 ms
	Program 3.2	76 ms/24 ms
Minimum switch-off time*1*2 (I2/I3)	Program 4, 5, and 6	24 ms
	Program 1, 2, 3, 7, 8, and 9	4 ms
Power-up time		70 ms
Synchronous time monitoring	Program 1 and 2	1500 ms
	Program 4 and 5	500 ms
Muting ON*3	Program 3	61 ms
Muting OFF	Program 3	61 ms (165 ms*4)
Muting gap suppression*5	Program 3	94 ms to 100 ms
Reset time		106 ms
Maximum teach-in time of the ENTER button*6		3 s
Duration of actuation of a reset button (X0 and X1)		50 ms to 5 s
Number of occupied input/output points		8 points (Either input or output is available for counting.)

\*1: The minimum switch-off time is the minimum time takes until a switch-off condition is detected after a module is switched off.

\*2: A response time without any sensors. When sensors are connected, the data of the connected sensors is applied and the minimum switch-off time is extended.

\*3: The time from when a muting condition is enabled (I2/I3 are turned ON) until a muting function is activated.

\*4: Indicates the maximum switch-off time when a muting error occurs.

\*5: A muting input (I2 or I3) keeps OFF for the specified period of time.

\*6: A time from when an ERROR LED starts flashing.

\*7: For details regarding the general inputs, refer to the manual.

## ● Safety inputs specifications (safety input expansion module)

Item		Specifications
		FX5-SF-8DI4
Connection type		Spring clamp terminal block
Number of inputs		8 points
Input voltage (ON)		13 V DC or more (13 V DC to 30 V DC)
Input voltage (OFF)		5 V DC or less (-5 V DC to 5 V DC)
Input current (ON)		3 mA (2.4 mA to 3.8 mA)
Input current (OFF)		2.1 mA or less (-2.5 mA to 2.1 mA)
Indication of input operation		LED lights when an input is ON.
Minimum switch-off time	Program 1, 2, 3, 4, 5, and 8	24 ms
	Program 6 and 7	4 ms
Synchronous time monitoring	Program 3 and 5	1500 ms
Power-up time		70 ms
Number of occupied input/output points		0 points (no occupied points)

● **Input specifications (Extension module (extension connector type), input, input/output module)**

Item	Specifications						
	FX5-C16EX/D	FX5-C32EX/D	FX5-C32ET/D	FX5-C16EX/DS	FX5-C32EX/DS	FX5-C32ET/DSS	FX5-C32EX/DS-TS, FX5-C32ET/DS(S)-TS
Connection type	Connector						Spring clamp terminal block
Input type	Sink			Sink/source			
Input signal voltage	24 V DC +20%, -15%						
Input signal current	4.0 mA/24 V DC						
Input impedance	5.6 kΩ						
Input sensitivity current	ON: 3.0 mA or more						
	OFF: 1.5 mA or less						
Input response time	ON: 50 μs or less OFF: 150 μs or less						
Input signal format	No-voltage contact input Sink: NPN open collector transistor			No-voltage contact input Sink: NPN open collector transistor Source: PNP open collector transistor			
Input circuit insulation	Photocoupler						
Indication of input operation	LED is lit when input is on		LED is lit when input is on (F/L of DISP switch is used to change between lower and higher numbers.)		LED is lit when input is on (DISP switch: IN)		LED is lit when input is on
Input circuit configuration							

● **Input specifications (Extension module (extension cable type), input, input/output module)**

Item	Specifications					
	FX5-8EX/ES	FX5-16EX/ES	FX5-16ER/ES	FX5-16ET/ES	FX5-16ET/ESS	FX5-16ET/ES-H FX5-16ET/ESS-H
Connection type	Screw terminal block					
Input type	Sink/source					
Input signal voltage	24 V DC +20%, -15%					
Input signal current	4.0 mA/24 V DC				5.3 mA/24 V DC	
Input impedance	5.6 kΩ				4.3 kΩ	
Input sensitivity current	ON: 3.0 mA or more				3.5 mA or more	
	OFF: 1.5 mA or less					
Input response time	ON: 50 μs or less OFF: 150 μs or less				X0 to 5 ON: 2.5 μs or less OFF: 2.5 μs or less X6, 7 ON: 30 μs or less OFF: 50 μs or less	
Input signal format	No-voltage contact input Sink: NPN open collector transistor Source: PNP open collector transistor					
Input circuit insulation	Photocoupler					
Indication of input operation	LED is lit when input is on					
Input circuit configuration	When using 24 V DC service power supply			When using external power supply		

For the general specifications for each model, refer to each manual.

# General, Power Supply, Input/Output Specifications

## ● Input specifications (Extension module powered input/output module)

Item	Specifications					
	FX5-32ER/ES	FX5-32ET/ES	FX5-32ET/ESS	FX5-32ER/DS	FX5-32ET/DS	FX5-32ET/DSS
Connection type	Screw terminal block					
Input type	Sink/source					
Input signal voltage	24 V DC +20%, -15%					
Input signal current	4.0 mA/24 V DC					
Input impedance	5.6 kΩ					
Input sensitivity current	ON	3.0 mA or more				
	OFF	1.5 mA or less				
Input response time	ON: 50 μs or less OFF: 150 μs or less					
Input signal format	No-voltage contact input Sink: NPN open collector transistor Source: PNP open collector transistor					
Input circuit insulation	Photocoupler					
Indication of input operation	LED is lit when input is on					
Input circuit configuration	<p>When using 24 V DC service power supply</p> <p>When using external power supply</p>					

## ◇ Output specifications

### ● Relay output (FX5S CPU module)

Item	Specifications		
	FX5S-30MR/ES	FX5S-40MR/ES	FX5S-60MR/ES
No. of output points	14 points	16 points	24 points
Connection type	Non-removable terminal block (M3 screws)		
Output type	Relay		
External power supply	30 V DC or less 240 V AC or less ("250 V AC or less" if not a CE, UL, cUL compliant item)		
Max. load	2 A/point The total load current per common terminal should be the following value. • 3 output points/common terminal: 6 A or less • 4 output points/common terminal: 8 A or less		
Min. load	5 V DC, 2 mA (reference values)		
Open circuit leakage current	-		
Response time	OFF→ON	Approx. 10 ms	
	ON→OFF	Approx. 10 ms	
Circuit insulation	Mechanical insulation		
Indication of output operation	LED is lit when output is on		
Output circuit configuration	<p>A number is entered in the □ of [COM□].</p>		

# General, Power Supply, Input/Output Specifications

## ● Relay output (FX5UJ CPU module)

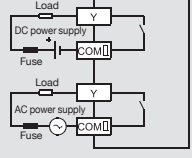
Item	Specifications		
	FX5U-24MR/ES	FX5UJ-40MR/ES	FX5UJ-60MR/ES
No. of output points	10 points (16 points)*	16 points	24 points
Connection type	Removable terminal block (M3 screws)		
Output type	Relay		
External power supply	30 V DC or less 240 V AC or less ("250 V AC or less" if not a CE, UL, cUL compliant item)		
Max. load	2 A/point The total load current per common terminal should be the following value. • 3 output points/common terminal: 6 A or less • 4 output points/common terminal: 8 A or less		
Min. load	5 V DC, 2 mA (reference values)		
Open circuit leakage current	-		
Response time	OFF→ON	Approx. 10 ms	
	ON→OFF	Approx. 10 ms	
Circuit insulation	Mechanical insulation		
Indication of output operation	LED is lit when output is on		
Output circuit configuration	 <p>A number is entered in the □ of [COM□].</p>		

\*: The number in parentheses represents occupied points.

## ● Relay output (FX5U CPU module)

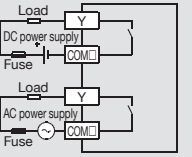
Item	Specifications		
	FX5U-32MR/□	FX5U-64MR/□	FX5U-80MR/□
No. of output points	16 points	32 points	40 points
Connection type	Removable terminal block (M3 screws)		
Output type	Relay		
External power supply	30 V DC or less 240 V AC or less ("250 V AC or less" if not a CE, UL, cUL compliant item)		
Max. load	2 A/point The total load current per common terminal should be the following value. • 4 output points/common terminal: 8 A or less • 8 output points/common terminal: 8 A or less		
Min. load	5 V DC, 2 mA (reference values)		
Open circuit leakage current	-		
Response time	OFF→ON	Approx. 10 ms	
	ON→OFF	Approx. 10 ms	
Circuit insulation	Mechanical insulation		
Indication of output operation	LED is lit when output is on		
Output circuit configuration	 <p>A number is entered in the □ of [COM□].</p>		

## ● Relay output (FX5UC CPU module)

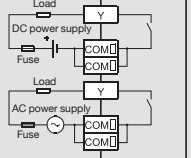
Items	Specifications	
	FX5UC-32MR/DS-TS	
No. of output points	16 points	
Connection type	Spring clamp terminal block	
Output type	Relay	
External power supply	30 V DC or less 240 V AC or less ("250 V AC or less" if not a CE, UL, cUL compliant item)	
Max. load	2 A/point The total load current per common terminal should be the following value. • 8 output points/common terminal: 4 A* or less	
Min. load	5 V DC, 2 mA (reference values)	
Open circuit leakage current	-	
Response time	OFF→ON	Approx. 10 ms
	ON→OFF	Approx. 10 ms
Circuit insulation	Mechanical insulation	
Indication of output operation	LED is lit when output is on	
Output circuit configuration	 <p>A number is entered in the □ of [COM□].</p>	

\*: 8 A or less when two common terminals are connected to the external part.

# General, Power Supply, Input/Output Specifications

## ● Transistor output (FX5S CPU module)

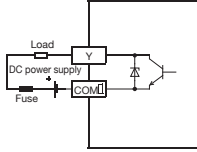
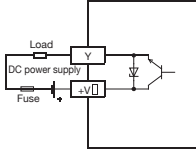
Item	Specifications		
	FX5S-30MT/□	FX5S-40MT/□	FX5S-60MT/□
No. of output points	14 points	16 points	24 points
Connection type	Non-removable terminal block (M3 screws)		
Output type	Transistor/sink output (FX5S-□MT/ES) Transistor/source output (FX5S-□MT/ESS)		
External power supply	5 to 30 V DC		
Max. load	0.5 A/point The total load current per common terminal should be the following value. • 3 output points/common terminal: 0.6 A or less • 4 output points/common terminal: 0.8 A or less		
Open circuit leakage current	0.1 mA or less/30 V DC		
Voltage drop when ON	Y0 to Y3	1.0 V or less	
	Y4 and subsequent	1.5 V or less	
Response time	Y0 to Y3	5 μs or less/10 mA or more (5 to 24 V DC)	
	Y4 and subsequent	0.2 ms or less/200 mA or more (24 V DC)	
Circuit insulation	Photocoupler		
Indication of output operation	LED is lit when output is on		
Output circuit configuration	Sink output wiring		Source output wiring
			
A number is entered in the □ of [COM□]. A number is entered in the □ of [+V□].			

## ● Transistor output (FX5UJ CPU module)

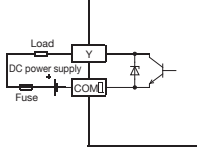
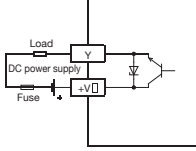
Item	Specifications		
	FX5UJ-24MT/□	FX5UJ-40MT/□	FX5UJ-60MT/□
No. of output points	10 points (16 points)*	16 points	24 points
Connection type	Removable terminal block (M3 screws)		
Output type	Transistor/sink output (FX5UJ-□MT/ES) Transistor/source output (FX5UJ-□MT/ESS)		
External power supply	5-30 V DC		
Max. load	0.5 A/point The total load current per common terminal should be the following value. • 3 output points/common terminal: 0.6 A or less • 4 output points/common terminal: 0.8 A or less		
Open circuit leakage current	0.1 mA or less/30 V DC		
Voltage drop when ON	Y0 to Y2	1.0 V or less	
	Y3 and subsequent	1.5 V or less	
Response time	Y0 to Y2	2.5 μs or less/10 mA or more (5-24 V DC)	
	Y3 and subsequent	0.2 ms or less/200 mA or more (24 V DC)	
Circuit insulation	Photocoupler		
Indication of output operation	LED is lit when output is on		
Output circuit configuration	Sink output wiring		Source output wiring
			
A number is entered in the □ of [COM□]. A number is entered in the □ of [+V□].			

\*: The number in parentheses represents occupied points.



## ● Transistor output (FX5U CPU module)

Item	Specifications		
	FX5U-32MT/□	FX5U-64MT/□	FX5U-80MT/□
No. of output points	16 points	32 points	40 points
Connection type	Screw terminal block		
Output type	Transistor/sink output (FX5U-□MT/ES, FX5U-□MT/DS) Transistor/source output (FX5U-□MT/ESS, FX5U-□MT/DSS)		
External power supply	5-30 V DC		
Max. load	0.5 A/point The total load current per common terminal should be the following value. <ul style="list-style-type: none"> <li>• 4 output points/common terminal: 0.8 A or less</li> <li>• 8 output points/common terminal: 1.6 A or less</li> </ul>		
Open circuit leakage current	0.1 mA or less/30 V DC		
Voltage drop when ON	Y0 to Y3	1.0 V or less	
	Y4 and subsequent	1.5 V or less	
Response time	Y0 to Y3	2.5 μs or less/10 mA or more (5-24 V DC)	
	Y4 and subsequent	0.2 ms or less/200 mA or more (24 V DC)	
Circuit insulation	Photocoupler		
Indication of output operation	LED is lit when output is on		
Output circuit configuration	Sink output wiring		Source output wiring
A number is entered in the □ of [COM□]. A number is entered in the □ of [+V□].			

## ● Transistor output (FX5UC CPU module)

Item	Specifications		
	FX5UC-32MT/□	FX5UC-64MT/□	FX5UC-96MT/□
No. of output points	16 points	32 points	48 points
Connection type	Connector (FX5UC-□MT/D(SS)) Spring clamp terminal block (FX5UC-32MT/DS(S)-TS)		
Output type	Transistor/sink output (FX5UC-□MT/D(S)-TS) Transistor/source output (FX5UC-□MT/DSS(+)-TS)		
External power supply	5-30 V DC		
Max. load	Y0 to Y3: 0.3 A/1 point Y4 and subsequent: 0.1 A/1 point The total load current per common terminal should be the following value. <ul style="list-style-type: none"> <li>• 8 output points/common terminal: 0.8 A or less*</li> </ul>		
Open circuit leakage current	0.1 mA or less/30 V DC		
Voltage drop when ON	Y0 to Y3	1.0 V or less	
	Y4 and subsequent	1.5 V or less	
Response time	Y0 to Y3	2.5 μs or less/10 mA or more (5-24 V DC)	
	Y4 and subsequent	0.2 ms or less/100 mA (24 V DC)	
Circuit insulation	Photocoupler		
Indication of output operation	LED is lit when output is on (DISP switch: OUT) (FX5UC-□MT/D(SS)) LED is lit when output is on (FX5UC-32MT/DS(S)-TS)		
Output circuit configuration	Sink output wiring		Source output wiring
A number is entered in the □ of [COM□]. A number is entered in the □ of [+V□].			

\*: 1.6 A or less when two common terminals are connected outside.

## General, Power Supply, Input/Output Specifications

### ● Safety outputs specifications (safety main module)

Item		Specifications
		FX5-SF-MU4T5*3
Connection type		Spring clamp terminal block
Number of outputs		4 points
Output method		Source output, short-circuit protection, cross-circuit detection*1
Output voltage		18.4 V DC to 30.0 V DC
Output current		2.0 A (@TA≤45°C) 1.5 A (@TA≤55°C)
Total current I <sub>sum</sub>		4.0 A (@TA≤45°C) 3.0 A (@TA≤55°C)
Leak current (in the switch OFF status)		1 mA or less
Indication of output operation		LED lights when an output is ON.
Response time*2 (I0/I1)	Program 1, 2, 4, 5, 6, and 9	29 ms
	Program 3.1, 7, and 8	9 ms
	Program 3.2	81 ms/29 ms
Response time*2 (I2/I3)	Program 4, 5, and 6	29 ms
	Program 1, 2, 3, 7, 8, and 9	9 ms
Response time (XS0)		9 ms
Off delay time		0 / 0.5 / 1 / 1.5 / 2 / 2.5 / 3 / 3.5 / 4 / 5 s
Number of occupied input/output points		8 points (Either input or output is available for counting.)

\*1: A cross-circuit detection is performed only in the module.

\*2: A response time without any sensors. When sensors are connected, the data of the connected sensors is applied and the minimum switch-off time is extended.

\*3: For details regarding the test outputs, refer to the manual.

# General, Power Supply, Input/Output Specifications

## ● Transistor output (sink output, extension module)

Item	Specifications										
	FX5-C16EYT/D	FX5-C32EYT/D	FX5-C32ET/D	FX5-C32EYT/D-TS	FX5-C32ET/DS-TS	FX5-8EYT/ES	FX5-16EYT/ES	FX5-16ET/ES	FX5-32ET/ES	FX5-32ET/DS	FX5-16ET/ES-H
Connection type	Connector			Spring clamp terminal block			Screw terminal block				
Output type	Transistor output/sink output										
External power supply	5 to 30 V DC										
Max. load	0.1 A/1 point The total load current per common terminal should be the following value. • 8 output points/common terminal: 0.8 A or less					0.5 A/1 point The total load current per common terminal should be the following value. • 4 output points/common terminal: 0.8 A or less • 8 output points/common terminal: 1.6 A or less					
Open circuit leakage current	0.1 mA/30 V DC										
Voltage drop when ON	1.5 V or less										
Response time	OFF→ON	0.2 ms or less/100 mA (at 24 V DC)				0.2 ms or less/200 mA (at 24 V DC)					Y0, Y1, Y4, Y5: 2.5 μs or less/10 mA (at 5 to 24 V DC) Y2, Y3, Y6, Y7: 0.2 ms or less/200 mA (at 24 V DC)
	ON→OFF	0.2 ms or less/100 mA (at 24 V DC)				0.2 ms or less/200 mA (at 24 V DC)					Y0, Y1, Y4, Y5: 2.5 μs or less/10 mA (at 5 to 24 V DC) Y2, Y3, Y6, Y7: 0.2 ms or less/200 mA (at 24 V DC)
Circuit insulation	Photocoupler										
Indication of output operation	LED is lit when output is on	LED is lit when output is on (F/L of DISP switch is used to change between lower and higher numbers.)	LED is lit when output is on (DISP switch: OUT)	LED is lit when output is on			LED is lit when output is on				
Output circuit configuration											

# General, Power Supply, Input/Output Specifications

## ● Transistor output (source output, extension module)

Item	Specifications											
	FX5-C16EYT/ DSS	FX5-C32EYT/ DSS	FX5-C32ET/ DSS	FX5-C32EYT/ DSS-TS	FX5-C32ET/ DSS-TS	FX5-8EYT/ ESS	FX5-16EYT/ ESS	FX5-16ET/ ESS	FX5-32ET/ ESS	FX5-32ET/ DSS	FX5-16ET/ ESS-H	
Connection type	Connector			Spring clamp terminal block		Screw terminal block						
Output type	Transistor output/sink output											
External power supply	5 to 30 V DC											
Max. load	0.1 A/1 point The total load current per common terminal should be the following value. • 8 output points/common terminal: 0.8 A or less					0.5 A/1 point The total load current per common terminal should be the following value. • 4 output points/common terminal: 0.8 A or less • 8 output points/common terminal: 1.6 A or less						
Open circuit leakage current	0.1 mA/30 V DC											
Voltage drop when ON	1.5 V or less											
Response time	OFF→ON	0.2 ms or less/100 mA (at 24 V DC)				0.2 ms or less/200 mA (at 24 V DC)					Y0, Y1, Y4, Y5: 2.5 μs or less/10 mA (at 5 to 24 V DC) Y2, Y3, Y6, Y7: 0.2 ms or less/ 200 mA (at 24 V DC)	
	ON→OFF	0.2 ms or less/100 mA (at 24 V DC)				0.2 ms or less/200 mA (at 24 V DC)					Y0, Y1, Y4, Y5: 2.5 μs or less/10 mA (at 5 to 24 V DC) Y2, Y3, Y6, Y7: 0.2 ms or less/ 200 mA (at 24 V DC)	
Circuit insulation	Photocoupler											
Indication of output operation	LED is lit when output is on	LED is lit when output is on (F/L of DISP switch is used to change between lower and higher numbers.)	LED is lit when output is on (DISP switch: OUT)	LED is lit when output is on			LED is lit when output is on					
Output circuit configuration												

## ● Relay output (extension module)

Item	Specifications					
	FX5-8EYR/ES	FX5-16EYR/ES	FX5-16ER/ES	FX5-32ER/ES	FX5-32ER/DS	FX5-C16EYR/D-TS
Connection type	Screw terminal block				Spring clamp terminal block	
Output type	Relay					
External power supply	30 V DC or less 240 V AC or less (*250 V AC or less* if not a CE, UL, cUL compliant item)					
Max. load	2 A/1 point The total load current per common terminal should be the following value. • 4 output points/common terminal: 8 A or less • 8 output points/common terminal: 8 A or less				2 A/1 point The total load current per common terminal should be the following value. • 8 output points/common terminal: 4 A or less*	
Min. load	5 V DC, 2 mA (reference values)					
Response time	OFF→ON	Approx. 10 ms				
	ON→OFF	Approx. 10 ms				
Circuit insulation	Mechanical insulation					
Indication of output operation	LED is lit when output is on					
Output circuit configuration						

\*: When two common terminals are connected outside the CPU module, resistance load is 8 A or less.

## General, Power Supply, Input/Output Specifications

### ● Built-in analog input

Item		Specifications	
		FX5U CPU module	
Analog input points		2 points (2 channels)	
Analog input	Voltage	0 to 10 V DC (input resistance 115.7 kΩ)	
Digital output		Unsigned 12-bit binary	
Device allocation		SD6020 (ch1 A/D converted input data) SD6060 (ch2 A/D converted input data)	
Input characteristics, maximum resolution	Digital output value	0 to 4000	
	Maximum resolution	2.5 mV	
Precision (Accuracy in respect to full-scale digital output value)	Ambient temperature 25±5°C	Within ±0.5% (±20 digit*2)	
	Ambient temperature 0 to 55°C	Within ±1.0% (±40 digit*2)	
	Ambient temperature -20 to 0°C*1	Within ±1.5% (±60 digit*2)	
Conversion speed		30 μs/channels (data refreshed every operation cycle)	
Absolute maximum input		-0.5 V, +15 V	
Isolation method		Non-isolation from the CPU module internal circuit, Non-isolation between the input terminals (channels)	
Number of occupied input/output points		0 points (does not pertain to the max. No. of input/output points of the CPU module.)	
Terminal block used		European-type terminal block	

\*1: Products manufactured earlier than June 2016 do not support this specification.

\*2: The term "digit" refers to "digital value".

### ● Built-in analog output

Item		Specifications	
		FX5U CPU module	
Analog output points		1 point (1 channel)	
Digital input		Unsigned 12-bit binary	
Analog output	Voltage	0 to 10 V DC (external load resistance 2 kΩ to 1 MΩ)	
Device allocation		SD6180 (Output setting data)	
Output characteristics, maximum resolution*1	Digital input value	0 to 4000	
	Maximum resolution	2.5 mV	
Accuracy*2 (Accuracy in respect to full-scale analog output value)	Ambient temperature 25±5°C	Within ±0.5% (±20 digit*4)	
	Ambient temperature 0 to 55°C	Within ±1.0% (±40 digit*4)	
	Ambient temperature -20 to 0°C*3	Within ±1.5% (±60 digit*4)	
Conversion speed		30 μs (data refreshed every operation cycle)	
Isolation method		Non-isolation from the CPU module internal circuit	
Number of occupied input/output points		0 points (does not pertain to the max. No. of input/output points of the CPU module.)	
Terminal block used		European-type terminal block	

\*1: There is a dead band near 0 V output, which is an area where some analog output values do not reflect digital input values.

\*2: External load resistance is set to 2 kΩ when shipped from the factory. Thus, output voltage will increase somewhat if the resistance is set higher than 2 kΩ. When the resistance is 1 MΩ, output voltage increases maximum 2%.

\*3: Products manufactured earlier than June 2016 do not support this specification.

\*4: The term "digit" refers to "digital value".

### ● Built-in RS-485 communication

Item	Specifications	
	FX5U/FX5UC CPU module	
Transmission standards	Conforms to RS-485/RS-422 specifications	
Data transmission speed	Max. 115.2 kbps	
Communication method	Full-duplex (FDX) / Half-duplex (HDX)	
Maximum transmission distance	50 m	
Protocol type	MELSOFT connection, MC protocol (1C/3C/4C frames), non-protocol communication, MODBUS RTU communication, inverter communication, N:N network, parallel link, communication protocol support	
Circuit insulation	Non-isolation	
Terminal resistors	Built-in (OPEN/110 Ω/330 Ω)	
Terminal block used	European-type terminal block	

# General, Power Supply, Input/Output Specifications

## ● Built-in Ethernet communication

Item	Specifications	
	FX5S/FX5UJ/FX5U/FX5UC CPU module	
Data transmission speed	100/10 Mbps	
Communication method	Full-duplex (FDX) / Half-duplex (HD <sub>X</sub> )*1	
Interface	RJ45 connector	
Transmission method	Base band	
Maximum segment length	100 m (The distance between hub and node)*2	
Cascade connection	100BASE-TX	Max. 2 stages*3
	10BASE-T	Max. 4 stages*3
Protocol type	CC-Link IE Field Network Basic, MELSOFT connection, SLMP server (3E/1E frame), socket communication, communication protocol support, FTP server, FTP client, MODBUS/TCP communication, SNT <sub>P</sub> client, Web server (HTTP), simple CPU communication function	
Number of connections	Total 8 connections*4 *5 (Up to 8 external devices can access one CPU module at the same time.)	
Hub*1	Hubs with 100BASE-TX or 10BASE-T ports*6 are available.	
IP address*7	Initial value: 192.168.3.250	
Circuit insulation	Pulse transformer insulation	
Cable used*8	For 100BASE-TX connection	Ethernet cable of category 5 or higher (STP cable)
	For 10BASE-T connection	Ethernet cable of category 3 or higher (STP cable)

\*1: IEEE802.3x flow control is not supported.

\*2: For maximum segment length (length between hubs), consult the manufacturer of the hub used.

\*3: Number of stages that can be connected when a repeater hub is used. When a switching hub is used, check the specifications of the switching hub used.

\*4: One device connected to MELSOFT is not included in the number of connections. (The second and subsequent devices are included.)

\*5: The CC-Link IE Field Network Basic, FTP server, FTP client, SNT<sub>P</sub> client, Web server and simple CPU communication function are not included in the number of connections.

\*6: The ports must comply with the IEEE802.3 100BASE-TX or IEEE802.3 10BASE-T standards.

\*7: If the 1st octet is 0 or 127, a parameter error (2222H) will result. (Example: 0.0.0.0, 127.0.0.0 etc.)

\*8: A straight cable can be used. If a personal computer or GOT and CPU module are directly connected a cross cable can be used.

## ● Built-in USB communication

Item	Specifications	
	FX5S/FX5UJ CPU module	
Data transmission speed	Full Speed (Max. 12 Mbps)	
Interface	Mini-B	

## ● Built-in positioning function

Item	Specifications	
	FX5UJ CPU module	FX5S/FX5U/FX5UC CPU module
Number of control axes	3 axes	4 axes* (Simple linear interpolation by 2-axis simultaneous start)
Maximum frequency	FX5S: 100kpps (100 kpps in pulses) FX5UJ, FX5U, FX5UC: 200kpps (200 kpps in pulses)	
Positioning program	Sequence program, Table operation	
Pulse output instruction	PLSY and DPLSY instructions	
Positioning instruction	DSZR, DDSZR, DVIT, DDVIT, TBL, DRVTBL, DRVMUL, DABS, PLSV, DPLSV, DRVI, DDRVI, DRVA, and DDRVA instructions	

\*: The number of control axes is 2 when the pulse output mode is CW/CCW mode.

## ● Built-in high-speed counter function

Item	Specifications		
	Input specifications	Frequency	
		FX5S/FX5UJ CPU module	FX5U/FX5UC CPU module
Types of high-speed counters	1-phase, 1-input counter (S/W)	100 kHz*1	200 kHz
	1-phase, 1-input counter (H/W)	100 kHz*1	200 kHz
	1-phase, 2-input counter	100 kHz	200 kHz
	2-phase, 2-input counter [1 edge count]	100 kHz	200 kHz
	2-phase, 2-input counter [2 edge count]	50 kHz	100 kHz
	2-phase, 2-input counter [4 edge count]	25 kHz	50 kHz
Input allocation	Parameter setup*2		
High-speed counter instruction	[High-speed processing instruction] - Setting 32-bit data comparison (DHSCS) - Resetting 32-bit data comparison (DHSCR) - Comparison of 32-bit data band (DHSZ) - Start/stop of the 16-bit data high-speed I/O function (HIOEN) - Start/stop of the 32-bit data high-speed I/O function (DHIOEN)		
	[High-speed transfer instruction of current value] - High-speed current value transfer of 16-bit data (HCMOV) - High-speed current value transfer of 32-bit data (DHCMOV)		

\*1: 1-phase, 1-input 100 kHz: 4 ch, 10 kHz: 4 ch

\*2: For details, refer to the manual.

## ◇ Extension device specifications I/O modules

### ● Powered input/output modules

Model	Total No. of points	No. of input/output points, Input/output type			Connection type	
		Input		Output		
FX5-32ER/ES	32 points	16 points	24 V DC (Sink/source)	16 points	Relay	Screw terminal block
FX5-32ET/ES				Transistor (Sink)		
FX5-32ET/ESS				Transistor (Source)		
FX5-32ER/DS				Relay		
FX5-32ET/DS				Transistor (Sink)		
FX5-32ET/DSS				Transistor (Source)		

### ● Input module

Model	Total No. of points	No. of input/output points, Input/output type			Connection type
		Input		Output	
FX5-8EX/ES	8 points	8 points	24 V DC (Sink/source)	—	Screw terminal block
FX5-16EX/ES	16 points	16 points	24 V DC (Sink)	—	Connector
FX5-C16EX/D			24 V DC (Sink/source)		
FX5-C32EX/D			24 V DC (Sink)		
FX5-C32EX/DS	32 points	32 points	24 V DC (Sink/source)	—	Spring clamp terminal block
FX5-C32EX/DS-TS					

### ● Output module

Model	Total No. of points	No. of input/output points, Input/output type			Connection type	
		Input		Output		
FX5-8EYR/ES	8 points	—	—	8 points	Relay	Screw terminal block
FX5-8EYT/ES				Transistor (Sink)		
FX5-8EYT/ESS				Transistor (Source)		
FX5-16EYR/ES	16 points	—	—	16 points	Relay	Screw terminal block
FX5-16EYT/ES					Transistor (Sink)	
FX5-16EYT/ESS					Transistor (Source)	
FX5-C16EYT/D					Transistor (Sink)	Connector
FX5-C16EYT/DSS					Transistor (Source)	
FX5-C16EYR/D-TS					Relay	
FX5-C32EYT/D	32 points	—	—	32 points	Transistor (Sink)	Spring clamp terminal block
FX5-C32EYT/D-TS					Transistor (Sink)	Spring clamp terminal block
FX5-C32EYT/DSS					Transistor (Source)	Connector
FX5-C32EYT/DSS-TS					Transistor (Source)	Spring clamp terminal block

### ● I/O module

Model	Total No. of points	No. of input/output points, Input/output type			Connection type	
		Input		Output		
FX5-16ER/ES	16 points	8 points	24 V DC (Sink/source)	8 points	Relay	Screw terminal block
FX5-16ET/ES				Transistor (Sink)		
FX5-16ET/ESS				Transistor (Source)		
FX5-C32ET/D	32 points	16 points	24 V DC (Sink)	16 points	Transistor (Sink)	Connector
FX5-C32ET/DS-TS			24 V DC (Sink/source)		Spring clamp terminal block	
FX5-C32ET/DSS			Transistor (Source)		Connector	
FX5-C32ET/DSS-TS			Transistor (Source)		Spring clamp terminal block	

### ● High-speed pulse input/output module

Model	Total No. of points	No. of input/output points, Input/output type			Connection type	
		Input		Output		
FX5-16ET/ES-H*	16 points	8 points	24 V DC (Sink/source)	8 points	Transistor (Sink)	Screw terminal block
FX5-16ET/ESS-H*				Transistor (Source)		

\*: Supported by FX5UJ/FX5U/FX5UC CPU module Ver. 1.030 or later.

# General, Power Supply, Input/Output Specifications

## ◇ Expansion adapter

### ● FX5-232ADP

Item	Specifications
Transmission standard/ Maximum transmission distance/insulation	Conforming to RS-232C/15 m/Photocoupler (Between communication line and CPU module)
External device connection method	9-pin D-sub, male
Communication method	Half-duplex bidirectional/Full-duplex bidirectional
Protocol type	MELSOFT connection, MC protocol (1C/3C/4C frame), non-protocol communication, MODBUS RTU communication, predefined protocol support
Baud rate	300/600/1200/2400/4800/9600/19200/38400/57600/115200 (bps)*1
Compatible CPU module	FX5S, FX5UJ, FX5U, FX5UC
Number of occupied input/output points	0 points (no occupied points)
Control power (supplied from CPU module)	5 V DC, 30 mA /24 V DC, 30 mA*2

\*1: The communication method and baud rate vary depending on the type of communication.

\*2: Current consumption calculation is not required for the FX5S/FX5UJ CPU module.

### ● FX5-485ADP

Item	Specifications
Transmission standard/ Maximum transmission distance/insulation	Conforming to RS-485, RS-422/1200 m/Photocoupler (Between communication line and CPU module)
External device connection method	European-type terminal block
Communication method	Half-duplex bidirectional/Full-duplex bidirectional
Protocol type	MELSOFT connection, MC protocol (1C/3C/4C frame), non-protocol communication, MODBUS RTU communication, inverter communication, N:N network, parallel link, predefined protocol support
Baud rate	300/600/1200/2400/4800/9600/19200/38400/57600/115200 (bps)*1
Terminal resistors	Built-in (OPEN/110 Ω/330 Ω)
Compatible CPU module	FX5S, FX5UJ, FX5U, FX5UC
Number of occupied input/output points	0 points (no occupied points)
Control power (supplied from CPU module)	5 V DC, 20 mA /24 V DC, 30 mA*2

\*1: The communication method and baud rate vary depending on the type of communication.

\*2: Current consumption calculation is not required for the FX5S/FX5UJ CPU module.

### ● FX5-4A-ADP

Item	Specifications				
Analog input	Analog input points	2 points (2 channels)			
	Analog input voltage	-10 to +10 V DC (input resistance 1 MΩ)			
	Analog input current	-20 to +20 mA DC (input resistance 250 Ω)			
	Digital output value	14-bit binary value			
	Input characteristics, resolution*1	Analog input range			
		Voltage	0 to 10 V	0 to 16000	625 μV
			0 to 5 V	0 to 16000	312.5 μV
			1 to 5 V	0 to 12800	312.5 μV
			-10 to +10 V	-8000 to +8000	1250 μV
		Current	0 to 20 mA	0 to 16000	1.25 μA
4 to 20 mA	0 to 12800		1.25 μA		
	-20 to +20 mA	-8000 to +8000	2.5 μA		
Accuracy (Accuracy in respect to full-scale digital output value)	Ambient temperature 25±5°C: within ±0.1% (±16 digits*2) Ambient temperature 0 to 55°C: within ±0.2% (±32 digits*2) Ambient temperature -20 to 0°C: within ±0.3% (±48 digits*2)				
Analog output	Analog output points	2 points (2 channels)			
	Digital input	14-bit binary value			
	Analog output voltage	-10 to +10 V DC (external load resistance value 1 kΩ to 1 MΩ)			
	Analog output current	0 to 20 mA DC (external load resistance value 0 to 500 Ω)			
	Output characteristics, resolution*1	Analog output range			
		Voltage	0 to 10 V	0 to 16000	625 μV
			0 to 5 V	0 to 16000	312.5 μV
			1 to 5 V	0 to 16000	250 μV
			-10 to +10 V	-8000 to +8000	1250 μV
		Current	0 to 20 mA	0 to 16000	1.25 μA
4 to 20 mA	0 to 16000		1 μA		
Accuracy (Accuracy in respect to full-scale analog output value)	Ambient temperature 25±5°C: ±0.1 % (Voltage ±20 mV, Current ±20 μA) Ambient temperature 0 to 55°C: ±0.2 % (Voltage ±40 mV, Current ±40 μA) Ambient temperature -20 to 0°C: ±0.3 % (Voltage ±60 mV, Current ±60 μA)				
External device connection method	European-type terminal block				
Absolute maximum input	Voltage: ±15 V, Current: ±30 mA				
Conversion speed	FX5S CPU module: Maximum 2.2 ms (The data will be updated at every scan time of the PLC.) FX5UJ/FX5U/FX5UC CPU module: Maximum 2.0 ms (The data will be updated at every scan time of the PLC.)				
Isolation method	Between input terminal and PLC: Photocoupler Between input channels: Non-isolation				
Power supply	24 V DC +20%, -15% 100 mA (external power supply)*3 5 V DC, 10 mA (internal power supply)*3				
Compatible CPU module	FX5S: Compatible from initial product      FX5UJ: Ver. 1.010 or later      FX5U, FX5UC: Ver. 1.240 or later				
Number of occupied input/output points	0 points (no occupied points)				

\*1: For details on the input conversion and output conversion characteristics, refer to the manual.

\*2: Digit refers to digital values.

\*3: Current consumption calculation is not required for the FX5S/FX5UJ CPU module.

For the general specifications for each model, refer to each manual.



# General, Power Supply, Input/Output Specifications

## ● FX5-4AD-ADP

Item	Specifications			
Analog input points	4 points (4 channels)			
External device connection method	European-type terminal block			
Analog input voltage	-10 to +10 V DC (input resistance 1 MΩ)			
Analog input current	-20 to +20 mA DC (input resistance 250 Ω)			
Digital output value	14-bit binary value			
Input characteristics, resolution*1	Analog input range			
	Voltage	0 to 10 V	0 to 16000	625 μV
		0 to 5 V	0 to 16000	312.5 μV
		1 to 5 V	0 to 12800	312.5 μV
		-10 to +10 V	-8000 to +8000	1250 μV
	Current	0 to 20 mA	0 to 16000	1.25 μA
4 to 20 mA		0 to 12800	1.25 μA	
-20 to +20 mA		-8000 to +8000	2.5 μA	
Accuracy (Accuracy in respect to full-scale digital output value)	Ambient temperature 25±5°C: within ±0.1% (±16 digit*2) Ambient temperature 0 to 55°C: within ±0.2% (±32 digit*2) Ambient temperature -20 to 0°C*3: within ±0.3% (±48 digit*2)			
Absolute maximum input	Voltage: ±15 V, Current: ±30 mA			
Conversion speed	FX5S CPU module: Maximum 500 μs (The data will be updated at every scan time of the PLC.) FX5UJ/FX5UJ/FX5UC CPU module: Maximum 450 μs (The data will be updated at every scan time of the PLC.)			
Isolation method	Between input terminal and PLC: Photocoupler Between input terminal channels: Non-isolation			
Power supply	24 V DC, 20 mA (internal power supply)*4 5 V DC, 10 mA (internal power supply)*4			
Compatible CPU module	FX5S, FX5UJ, FX5U, FX5UC			
Number of occupied input/output points	0 points (no occupied points)			

- \*1: For the input conversion characteristic, refer to manuals of each product.
- \*2: Digit refers to digital values.
- \*3: Products manufactured earlier than June 2016 do not support this specification.
- \*4: Current consumption calculation is not required for the FX5S/FX5UJ CPU module.

## ● FX5-4AD-TC-ADP

Item	Specifications			
Analog input points	4 points (4 channels)			
External device connection method	European-type terminal block			
Usable thermocouple	K, J, T, B, R, S			
Temperature measuring range	K	-200 to 1200°C (-328 to 2192°F)		
	J	-40 to 750°C (-40 to 1382°F)		
	T	-200 to 350°C (-328 to 662°F)		
	B	600 to 1700°C (1112 to 3092°F)		
	R	0 to 1600°C (32 to 2912°F)		
	S	0 to 1600°C (32 to 2912°F)		
Digital output value	16-bit signed binary value			
	K	-2000 to 12000 (-3280 to 21920)		
	J	-400 to 7500 (-400 to 13820)		
	T	-2000 to 3500 (-3280 to 6620)		
	B	6000 to 17000 (11120 to 30920)		
	R	0 to 16000 (320 to 29120)		
Accuracy*1	Ambient temperature 25±5°C	K	±3.7°C (-100 to 1200°C)*2	±4.9°C (-150 to -100°C)*2
		J	±2.8°C	
		T	±3.1°C (0 to 350°C)*2	±4.1°C (-100 to 0°C)*2
		B	±5.0°C (-150 to -100°C)*2	±6.7°C (-200 to -150°C)*2
		R	±3.5°C	
		S	±3.7°C	
	Ambient temperature -20 to 55°C	K	±6.5°C (-100 to 1200°C)*2	±7.5°C (-150 to -100°C)*2
		J	±4.5°C	
		T	±4.1°C (0 to 350°C)*2	±5.1°C (-100 to 0°C)*2
		B	±6.0°C (-150 to -100°C)*2	±7.7°C (-200 to -150°C)*2
		R	±6.5°C	
		S	±6.5°C	
Resolution	K, J, T	0.1°C (0.1 to 0.2°F)		
	B, R, S	0.1 to 0.3°C (0.1 to 0.6°F)		
Conversion speed*3	About 85 ms/channel			
Isolation method	Between input terminal and CPU module: Photocoupler Between input terminal channels: Non-isolation			
Power supply	24 V DC, 20 mA (internal power supply)*4 5 V DC, 10 mA (internal power supply)*4			
Compatible CPU module	FX5S, FX5UJ: Compatible from initial product FX5U, FX5UC: Ver. 1.040 or later			
Number of occupied I/O points	0 points (no occupied points)			

- \*1: Obtaining sufficient accuracy requires a warm-up of 45 minutes (energization).
- \*2: Accuracy varies depending on the measured temperature range in ( ).
- \*3: For details of conversion speeds, refer to the manual.
- \*4: Current consumption calculation is not required for the FX5S/FX5UJ CPU module.

## ● FX5-4AD-PT-ADP

Item	Specifications		
Analog input points	4 points (4 channels)		
External device connection method	European-type terminal block		
Usable resistance temperature detector*1	Pt100 Ni100 (DIN 43760 1987)		
Temperature measuring range	Pt100	-200 to 850°C (-328 to 1562°F)	
	Ni100	-60 to 250°C (-76 to 482°F)	
Digital output value	16-bit signed binary value		
Accuracy	Ambient temperature 25±5°C	Pt100	±0.8°C
		Ni100	±0.4°C
	Ambient temperature -20 to 55°C	Pt100	±2.4°C
		Ni100	±1.2°C
Resolution	0.1°C (0.1 to 0.2°F)		
Conversion speed*2	About 85 ms/channel		
Isolation method	Between input terminal and CPU module: Photocoupler Between input terminal channels: Non-isolation		
Power supply	24 V DC, 20 mA (internal power supply)*3 5 V DC, 10 mA (internal power supply)*3		
Compatible CPU module	FX5S, FX5UJ: Compatible from initial product FX5U, FX5UC: Ver. 1.040 or later		
Number of occupied I/O points	0 points (no occupied points)		

- \*1: Only 3-wire type resistance temperature detectors can be used.
- \*2: For details of conversion speeds, refer to the manual.
- \*3: Current consumption calculation is not required for the FX5S/FX5UJ CPU module.

# General, Power Supply, Input/Output Specifications

## ● FX5-4DA-ADP

Item	Specifications			
Analog output points	4 points (4 channels)			
External device connection method	European-type terminal block			
Analog output voltage	-10 to +10 V DC (external load resistance value 1 k $\Omega$ to 1 M $\Omega$ )			
Analog output current	0 to 20 mA DC (external load resistance value 0 to 500 $\Omega$ )			
Digital input	14-bit binary value			
Output characteristics, resolution*1	Analog output range		Resolution	
	Voltage	0 to 10 V	0 to 16000	625 $\mu$ V
		0 to 5 V	0 to 16000	312.5 $\mu$ V
		1 to 5 V	0 to 16000	250 $\mu$ V
		-10 to +10 V	-8000 to +8000	1250 $\mu$ V
	Current	0 to 20 mA	0 to 16000	1.25 $\mu$ A
4 to 20 mA		0 to 16000	1 $\mu$ A	
Accuracy (Accuracy in respect to full-scale analog output value)	Ambient temperature 25 $\pm$ 5 $^{\circ}$ C: within $\pm$ 0.1% (Voltage $\pm$ 20 mV, Current $\pm$ 20 $\mu$ A) Ambient temperature -20 to 55 $^{\circ}$ C*2: within $\pm$ 0.2% (Voltage $\pm$ 40 mV, Current $\pm$ 40 $\mu$ A)			
Conversion speed	FX5S CPU module: Maximum 1100 $\mu$ s (The data will be updated at every scan time of the PLC.) FX5UJ/FX5U/FX5UC CPU module: Maximum 950 $\mu$ s (The data will be updated at every scan time of the PLC.)			
Isolation method	Between output terminal and PLC: Photocoupler Between output terminal channels: Non-isolation			
Power supply	24 V DC +20%, -15% 160 mA (external power supply) 5 V DC, 10 mA (internal power supply)*3			
Compatible CPU module	FX5S, FX5UJ, FX5U, FX5UC			
Number of occupied input/output points	0 points (no occupied points)			

\*1: For details on the output conversion characteristic, refer to manuals of each product.

\*2: The ambient temperature specification is 0 to 55 $^{\circ}$ C for products manufactured earlier than June 2016.

\*3: Current consumption calculation is not required for the FX5S/FX5UJ CPU module.

## ◇ Expansion board

Item	Specifications			
	FX5-232-BD	FX5-485-BD	FX5-422-BD-GOT	FX5-SDCD
Transmission standards	Conforming to RS-232C	Conforming to RS-485, RS-422	Conforming to RS-422	—
Maximum transmission distance	15 m	50 m	According to the specification of the GOT	—
External device connection method	9-pin D-sub, male	European-type terminal block	8-pin MINI-DIN, female	—
Insulation	Non-isolation (between communication line and CPU)	Non-isolation (between communication line and CPU)	Non-isolation (between communication line and CPU)	—
Communication method	Half-duplex bidirectional/full duplex bidirectional*1	Half-duplex bidirectional/full duplex bidirectional*1	Half-duplex bidirectional	—
Protocol type	MELSOFT connection, MC protocol (1C/3C/4C frame), non-protocol communication, MODBUS RTU communication, predefined protocol support	MELSOFT connection, MC protocol (1C/3C/4C frame), non-protocol communication, MODBUS RTU communication, inverter communication, N:N network, parallel link, predefined protocol support	—	—
Baud rate	300/600/1200/2400/4800/9600/19200/38400/57600/115200 (bps)*1	300/600/1200/2400/4800/9600/19200/38400/57600/115200 (bps)*1	9600/19200/38400/57600/115200 (bps)	—
Terminal resistors	—	Built-in (OPEN/110 $\Omega$ /330 $\Omega$ )	—	—
SD memory card	—	—	—	NZ1MEM-2GBSD, NZ1MEM-4GBSD, NZ1MEM-8GBSD, NZ1MEM-16GBSD
Power supply	5 V DC, 20 mA (internal power supply)*2	5 V DC, 20 mA (internal power supply)*2	5 V DC, 20 mA (internal power supply)*2*3	—
Compatible CPU module	FX5S, FX5UJ, FX5U	FX5S, FX5UJ, FX5U	FX5S, FX5UJ, FX5U	FX5S
Number of occupied input/output points	0 points (no occupied points)	0 points (no occupied points)	0 points (no occupied points)	0 points (no occupied points)

\*1: The communication method and baud rate vary depending on the type of communication.

\*2: Current consumption calculation is not required for the FX5S/FX5UJ CPU module.

\*3: When the GOT 5 V type is connected with this product, the power consumption increases. For the current consumption, refer to the manual of the model to be connected.

## ◇ Extension power supply module

### ● FX5-1PSU-5V

Item	Specifications
Rated supply voltage	100 to 240 V AC
Voltage fluctuation range	-15%, +10%
Frequency rating	50/60 Hz
Allowable instantaneous power failure time	Operation can be continued upon occurrence of instantaneous power failure for 10 ms or less.
Power fuse	250 V, 3.15 A time-lag fuse
Rush current	25 A Max. 5 ms or less/100 V AC 50 A Max. 5 ms or less/200 V AC
Power consumption	20 W Max.
Output current* (For power supply to rear stage)	24 V DC: 300 mA (Maximum output current depends on the ambient temperature.) 5 V DC: 1200 mA (Maximum output current depends on the ambient temperature.)
Compatible CPU module	FX5UJ, FX5U (AC power supply type)
Number of occupied input/output points	0 points (no occupied points)

\*: For details on the current conversion characteristic, refer to manuals of each product.

### ● FX5-C1PS-5V

Item	Specifications
Supply voltage	24 V DC
Voltage fluctuation range	+20%, -15%
Allowable instantaneous power failure time	Operation can be continued upon occurrence of instantaneous power failure for 5 ms or less.
Power fuse	125 V, 3.15 A time-lag fuse
Rush current	35 A Max. 0.5 ms or less/24 V DC
Power consumption	30 W Max.
Output current* (For power supply to rear stage)	24 V DC: 625 mA (Maximum output current depends on the ambient temperature.) 5 V DC: 1200 mA (Maximum output current depends on the ambient temperature.)
Compatible CPU module	FX5U (DC power supply type), FX5UC
Number of occupied input/output points	0 points (no occupied points)

\*: For details on the current conversion characteristic, refer to manuals of each product.

## ◇ Bus conversion module

### ● FX5-CNV-BUS (FX5 (extension cable type)–FX3 extension)

Item	Specifications
Compatible CPU module	FX5U, FX5UC
Number of occupied input/output points	8 points (Either input or output is available for counting.)
Control power (supplied from PLC)	5 V DC 150 mA

### ● FX5-CNV-BUSC (FX5 (extension connector type)–FX3 extension)

Item	Specifications
Compatible CPU module	FX5U, FX5UC
Number of occupied input/output points	8 points (Either input or output is available for counting.)
Control power (supplied from PLC)	5 V DC 150 mA

## ◇ Connector conversion module

### ● FX5-CNV-IF (FX5 (extension cable type)–FX5 (extension connector type) extension)

Item	Specifications
Compatible CPU module	FX5UJ, FX5U
Number of occupied input/output points	0 points (no occupied points)
Control power (supplied from PLC)	0 mA (no power consumed)

### ● FX5-CNV-IFC (FX5 (extension connector type)–FX5 (extension cable type) extension)

Item	Specifications
Compatible CPU module	FX5UC
Number of occupied input/output points	0 points (no occupied points)
Control power (supplied from PLC)	0 mA (no power consumed)

## ◇ Intelligent function module

### ● FX5-4AD

Items		Specifications		
Analog input points		4 points (4 channels)		
External device connection method		Spring clamp terminal block		
Analog input voltage		-10 to +10 V DC (Input resistance 400 k $\Omega$ or more)		
Analog input current		-20 to +20 mA DC (Input resistance 250 $\Omega$ )		
Absolute maximum input		Voltage: $\pm 15$ V, Current: $\pm 30$ mA		
Input characteristics, resolution*1	Voltage	Analog input range	Digital output value	Resolution
		0 to 10 V	0 to 32000	312.5 $\mu$ V
		0 to 5 V	0 to 32000	156.25 $\mu$ V
		1 to 5 V	0 to 32000	125 $\mu$ V
	Current	-10 to +10 V	-32000 to +32000	312.5 $\mu$ V
		User range setting	-32000 to +32000	125 $\mu$ V*2
		0 to 20 mA	0 to 32000	625 nA
		4 to 20 mA	0 to 32000	500 nA
Digital output value	Voltage/Current	16-bit signed binary (-32768 to +32767)		
Accuracy (accuracy for the full scale digital output value)	Voltage/Current	Ambient temperature 25 $\pm$ 5°C: within $\pm 0.1\%$ ( $\pm 64$ digits*3)		
		Ambient temperature 0 to 55°C: within $\pm 0.2\%$ ( $\pm 128$ digits*3)		
		Ambient temperature -20 to 0°C: within $\pm 0.3\%$ ( $\pm 192$ digits*3)		
Conversion speed		80 $\mu$ s/ch		
Isolation method		Between input terminal and PLC: Photocoupler Between input terminal channels: Non-isolation		
Power supply		24 V DC, 40 mA (internal power supply) 5 V DC, 100 mA (internal power supply)		
Compatible CPU module		FX5UJ: Compatible from initial product FX5U, FX5UC: Ver. 1.050 or later Connection with FX5UC CPU module requires connector conversion module (FX5-CNV-IFC) or extension power supply module (FX5-C1PS-5V).		
Number of occupied I/O points		8 points (Either input or output is available for counting.)		

\*1: For details on the input conversion characteristics, refer to the manual.

\*2: Maximum resolution in the user range setting.

\*3: Digit refers to digital values.

### ● FX5-4DA

Items		Specifications		
Analog output points		4 points (4 channels)		
External device connection method		Spring clamp terminal block		
Analog output voltage		-10 to +10 V DC (External load resistance 1 k $\Omega$ to 1 M $\Omega$ )		
Analog output current		0 to 20 mA DC (External load resistance 0 to 500 $\Omega$ )		
Output characteristics, resolution*1	Voltage	Analog output range	Digital value	Resolution
		0 to 10 V	0 to 32000	312.5 $\mu$ V
		0 to 5 V	0 to 32000	156.3 $\mu$ V
		1 to 5 V	0 to 32000	125 $\mu$ V
	Current	-10 to +10 V	-32000 to +32000	312.5 $\mu$ V
		User range setting	-32000 to +32000	312.5 $\mu$ V*2
		0 to 20 mA	0 to 32000	625 nA
		4 to 20 mA	0 to 32000	500 nA
Digital input	Voltage/Current	16-bit signed binary (-32768 to +32767)		
Accuracy (accuracy for the full scale analog output value)	Voltage/Current	Ambient temperature 25 $\pm$ 5°C: within $\pm 0.1\%$ (Voltage $\pm 20$ mV, Current $\pm 20$ $\mu$ A)		
		Ambient temperature 0 to 55°C: within $\pm 0.2\%$ (Voltage $\pm 40$ mV, Current $\pm 40$ $\mu$ A)		
		Ambient temperature -20 to 0°C: within $\pm 0.3\%$ (Voltage $\pm 60$ mV, Current $\pm 60$ $\mu$ A)		
Conversion speed		80 $\mu$ s/ch		
Isolation method		Between output terminal and PLC: Photocoupler Between output channels: Non-isolation		
Power supply		5 V DC, 100 mA (internal power supply) 24 V DC, +20%, -15% 150 mA (external power supply)		
Compatible CPU module		FX5UJ: Compatible from initial product FX5U, FX5UC: Ver. 1.050 or later Connection with FX5UC CPU module requires connector conversion module (FX5-CNV-IFC) or extension power supply module (FX5-C1PS-5V).		
Number of occupied I/O points		8 points (Either input or output is available for counting.)		

\*1: For details on the output conversion characteristics, refer to the manual.

\*2: Maximum resolution in the user range setting.

For the general specifications for each model, refer to each manual.

# General, Power Supply, Input/Output Specifications

## ● FX5-8AD

Item	Specifications			
Analog input points	8 points (8 channels)			
External device connection method	Spring clamp terminal block			
Analog input voltage	-10 to +10 V DC (input resistance 1 MΩ)			
Analog input current	-20 to +20 mA DC (input resistance 250 Ω)			
Absolute maximum input	Voltage: ±15 V, Current: ±30 mA			
Input characteristics, resolution*1	Thermocouple	K, J, T: 0.1°C (0.1 to 0.2°F) B, R, S: 0.1 to 0.3°C (0.1 to 0.6°F)		
	Resistance temperature detector	0.1°C (0.2°F)		
	Voltage	Analog input range	Digital output value	Resolution
		0 to 10 V	0 to 32000	312.5 μV
		0 to 5 V	0 to 32000	156.25 μV
		1 to 5 V	0 to 32000	125 μV
Current	-10 to +10 V	-32000 to +32000	312.5 μV	
	0 to 20 mA	0 to 32000	625 nA	
	4 to 20 mA	0 to 32000	500 nA	
Digital output value (16-bit signed binary value)	Thermocouple	K: -2000 to +12000 (-3280 to +21920) J: -400 to +7500 (-400 to +13820) T: -2000 to +3500 (-3280 to +6620) B: 6000 to 17000 (11120 to 30920) R: 0 to 16000 (320 to 29120) S: 0 to 16000 (320 to 29120)		
		Resistance temperature detector	Pt100: -2000 to +8500 (-3280 to +15620) Ni100: -600 to +2500 (-760 to +4820)	
	Voltage/Current	16-bit signed binary (-32000 to +32000)		
	Resistance temperature detector	Ambient temperature 25±5°C	Pt100: ±0.8°C Ni100: ±0.4°C	
Accuracy*2	Thermocouple	Ambient temperature -20 to 55°C	Pt100: ±2.4°C Ni100: ±1.2°C	
		Ambient temperature 25±5°C	K: ±3.5°C (-200 to -150°C) K: ±1.5°C (-100 to 1200°C) T: ±3.5°C (-200 to -150°C) T: ±1.5°C (-100 to 350°C) R: ±2.5°C	K: ±2.5°C (-150 to -100°C) J: ±1.2°C T: ±2.5°C (-150 to -100°C) B: ±2.3°C S: ±2.5°C
		Ambient temperature -20 to 55°C	K: ±8.5°C (-200 to -150°C) K: ±6.5°C (-100 to 1200°C) T: ±5.2°C (-200 to -150°C) T: ±3.1°C (-100 to 350°C) R: ±6.5°C	K: ±7.5°C (-150 to -100°C) J: ±3.5°C T: ±4.2°C (-150 to -100°C) B: ±6.5°C S: ±6.5°C
		Ambient temperature 25±5°C	Within ±0.3% (±192 digits*4)	
	Voltage/Current*3	Ambient temperature -20 to 55°C	Within ±0.5% (±320 digits*4)	
Conversion speed	Voltage/Current	1 ms/ch		
	Thermocouple/Resistance temperature detector	40 ms/ch		
Isolation method	Between input terminal and PLC: Photocoupler Between input terminal channels: Non-isolation			
Power supply	24 V DC, 40 mA (internal power supply) 24 V DC +20%, -15% 100 mA (external power supply)			
Compatible CPU module	FX5UJ: Compatible from initial product FX5U, FX5UC: Ver. 1.050 or later Connection with FX5UC CPU module requires connector conversion module (FX5-CNV-IFC) or extension power supply module (FX5-C1PS-5V).			
Number of occupied I/O points	8 points (Either input or output is available for counting.)			

- \*1: For details on the input conversion characteristics, refer to the manual.
- \*2: To stabilize the accuracy, warm-up (supply power) the system for 30 minutes or more after power-on.
- \*3: Accuracy for the full scale digital output value.
- \*4: Digit refers to digital values.

For the general specifications for each model, refer to each manual.

# General, Power Supply, Input/Output Specifications

## ● FX5-4LC

Item		Specifications		
Control system		Two-position control, standard PID control, heating/cooling PID control, cascade control		
External device connection method		Spring clamp terminal block		
Control operation cycle		250 ms/4 ch		
Temperature measuring range	Thermocouple	K: -200 to +1300°C (-100 to +2400°F) J: -200 to +1200°C (-100 to +2100°F) T: -200 to +400°C (-300 to +700°F) S: 0 to 1700°C (0 to 3200°F) R: 0 to 1700°C (0 to 3200°F) E: -200 to +1000°C (0 to 1800°F) B: 0 to 1800°C (0 to 3000°F) N: 0 to 1300°C (0 to 2300°F) PLI: 0 to 1200°C (0 to 2300°F) W5Re/W26Re: 0 to 2300°C (0 to 3000°F) U: -200 to +600°C (-300 to +700°F) L: 0 to 900°C (0 to 1600°F)		
	Resistance temperature detector	Pt100 (3-wire type): -200 to +600°C (-300 to +1100°F) JPT100 (3-wire type): -200 to +500°C (-300 to +900°F) Pt1000 (2-wire/3-wire type): -200.0 to +650.0°C (-328 to +1184°F)		
	Micro voltage input	0 to 10 mV DC, 0 to 100 mV DC		
Heater disconnection detection		Alarm detection		
Input specifications	Number of input points	4 points		
	Input type	Thermocouple	K, J, R, S, E, T, B, N, PLII, W5Re/W26Re, U, L	
		Resistance temperature detector	3-wire type Pt100 3-wire type JPT100 2-wire/3-wire type Pt1000	
		Micro voltage input		
	Measurement accuracy*	Refer to the MELSEC iQ-F FX5 User's Manual (Temperature Control).		
	Cold junction temperature compensation error	Ambient temperature 0 to 55°C	Within ±1.0°C. When the input value is -150 to -100°C: Within ±2.0°C When the input value is -200 to -150°C: Within ±3.0°C	
		Ambient temperature -20 to 0°C	Within ±1.8°C. When the input value is -150 to -100°C: Within ±3.6°C When the input value is -200 to -150°C: Within ±5.4°C	
	Resolution	0.1°C (0.1°F), 1.0°C (1.0°F), 0.5 μV, or 5.0 μV (depends on the input range of the sensor used)		
	Sampling cycle	250 ms/4 ch		
	Influence of input conductor resistance (for resistance temperature detector input)	3-wire type	About 0.03%/Ω for full scale, and 10 Ω or less per line	
		2-wire type	About 0.04%/Ω for full scale, and 7.5 Ω or less per line	
	Influence of external resistance (for thermocouple input)	About 0.125 μV/Ω		
Input impedance	1 MΩ or more			
Sensor current	About 0.2 mA (for resistance temperature detector input)			
Operation at input disconnection/short circuit	Upscale/downscale (for resistance temperature detector input)			
Output specifications	Number of points: 4 Type: NPN open collector transistor output, Rated load voltage: 5 to 24 V DC Maximum load current: 100 mA, Control output cycle: 0.5 to 100.0 seconds			
Power supply	5 V DC, 140 mA (internal power supply) 24 V DC +20%, -15% 25 mA (external power supply)			
Isolation method	<ul style="list-style-type: none"> <li>The analog input part and between the transistor output part and PLC are insulated by the photocoupler.</li> <li>The analog input part and between the transistor output part and power supply are insulated by the DC-DC converter.</li> <li>Insulated between channels</li> </ul>			
Compatible CPU module	FX5UJ: Compatible from initial product FX5U, FX5UC: Ver. 1.050 or later Connection with FX5UC CPU module requires connector conversion module (FX5-CNV-IFC) or extension power supply module (FX5-C1PS-5V).			
Number of occupied I/O points	8 points (Either input or output is available for counting.)			

\*: To stabilize the accuracy, warm-up (supply power) the system for 30 minutes or more after power-on.

## ● FX5-20PG-P, FX5-20PG-D

Item	Specifications	
	FX5-20PG-P	FX5-20PG-D
Number of control axes	2 axes	
Command Speed	200 kpps	5 Mpps
Pulse Output	Output signal: PULSE/SIGN mode, CW/CCW mode, phase A/B (4 multiplication), phase A/B (1 multiplication) Output terminal: Transistor 5 to 24 V DC 50 mA or less	Output signal: PULSE/SIGN mode, CW/CCW mode, phase A/B (4 multiplication), phase A/B (1 multiplication) Output terminal: Differential driver equivalent to AM26C31
External I/O specifications	Input: READY/STOP/FLS/RLS/PG024/DOG/CHG terminals: 24 V DC 5 mA, PULSER A/PULSER B terminals: 5 V DC 14 mA Zero point signal PG05 terminal: 5 V DC 5 mA Output: CLEAR (deviation counter): 5 to 24 V DC 100 mA or less Circuit insulation: Photocoupler	
Power supply	24 V DC +20%, -15% 120 mA (external power supply)	24 V DC +20%, -15% 165 mA (external power supply)
Compatible CPU module	FX5UJ: Compatible from initial product FX5U, FX5UC: Ver. 1.050 or later Connection with FX5UC CPU module requires connector conversion module (FX5-CNV-IFC) or extension power supply module (FX5-C1PS-5V).	
Number of occupied I/O points	8 points (Either input or output is available for counting.)	

For the general specifications for each model, refer to each manual.

# General, Power Supply, Input/Output Specifications

## ● FX5-ENET

Items		Specifications		
CC-Link IE Field Network Basic	Station type	Master station		
	Maximum number of connectable stations*1	32		
	Number of stations occupied by a remote station	1 to 4		
	Maximum number of link points per network	RX	2048 points	
		RY	2048 points	
		RWr	1024 points	
		RWw	1024 points	
	Maximum number of link points per station	Master station	RX	2048 points
			RY	2048 points
			RWr	1024 points
			RWw	1024 points
		Remote station*2	RX	64/128/192/256 points
			RY	64/128/192/256 points
			RWr	32/64/96/128 points
			RWw	32/64/96/128 points
UDP port number used in the cyclic transmission		61450		
UDP port number used in automatic detection of connected devices		Master station: An unused port number is assigned automatically. Remote station: 61451		
Transmission specifications	Data transfer speed	100 Mbps		
	Maximum station-to-station distance	100 m		
	Overall cable distance	Depends on the system configuration		
	Number of cascade connections	100BASE-TX When using a switching hub, check the number of cascaded stages with the manufacturer of the hub to be used.		
Network topology		Line topology, star topology (Coexistence of line topology and star topology is also possible.)		
Hub*3		Hubs with 100BASE-TX ports*4 can be used.		
Connection cable*5		100BASE-TX Ethernet cable of category 5 or higher (STP cable)		
General-purpose Ethernet communication	Transmission specifications	Data transfer speed	100/10 Mbps	
		Communication mode	Full-duplex or half-duplex*3	
		Transmission method	Base band	
		Interface	RJ45 connector	
		Maximum segment length (Maximum distance between hub and node)	100 m*6	
		Number of cascade connections	100BASE-TX 10BASE-T 2 levels maximum*7 4 levels maximum*7	
	Protocol type*8		MELSOFT connection, SLMP server (3E/1E frame), Socket communication, simple CPU communication, BACnet/IP	
	Number of connections		Total of 32 connections*9 (Up to 32 external devices can access one FX5-ENET module at the same time.)	
	Hub*3		Hubs with 100BASE-TX or 10BASE-T ports*10 can be used.	
	Connection cable*5		100BASE-TX 10BASE-T Ethernet cable of category 5 or higher (STP cable) Ethernet cable of category 3 or higher (STP/UTP cable)	
Number of ports		2*11		
Power supply		24 V DC, 110 mA (internal power supply)		
Compatible CPU module		FX5UJ: Compatible from initial product FX5U, FX5UC: Ver. 1.110 or later Connection with FX5UC CPU module requires connector conversion module (FX5-CNV-IFC) or extension power supply module (FX5-C1PS-5V).		
Number of occupied I/O points		8 points (Either input or output is available for counting.)		

- \*1 : Maximum number of connected remote stations that FX5-ENET (master station) can manage.
- \*2 : Value for 1-station occupation, 2-station occupation, 3-station occupation, or 4-station occupation.
- \*3 : IEEE802.3x flow control is not supported.
- \*4 : The ports must comply with the IEEE802.3 100BASE-TX standards.
- \*5 : A straight/cross cable can be used.
- \*6 : For maximum segment length (length between hubs), consult the manufacturer of the hub used.
- \*7 : This number applies when a repeater hub is used. When using a switching hub, check the number of cascaded stages with the manufacturer of the hub to be used.
- \*8 : For a compatible version of each protocol, refer to the following manual.  
→ MELSEC iQ-F FX5-ENET User's Manual
- \*9 : The first device for MELSOFT connection is not included in the number of connections. (The second and the following devices are included.)  
The CC-Link IE field network Basic is not included in the number of connections.
- \*10 : The ports must comply with the IEEE802.3 100BASE-TX or IEEE802.3 10BASE-T standards.
- \*11 : Since the IP address is shared by two ports, only one address can be set.

For the general specifications for each model, refer to each manual.

# General, Power Supply, Input/Output Specifications

## ● FX5-ENET/IP

Items		Specifications	
EtherNet/IP communications	Class 1 communications	Communication format	Standard EtherNet/IP
		Number of connections	32
		Communication data size	1444 bytes (per connection)
		Connection type	Point-to-point, multicast
		RPI (communication cycle)	2 to 60000 ms
		PPS (communication processing performance)	3000 pps (case of 128 bytes)
	Class 3 communications*1	Communication format	Standard EtherNet/IP
		Number of connections	32*2
		Connection type	Point-to-point
	UCMM communications	Communication format	Standard EtherNet/IP
		Number of connections (number of simultaneous executions)	32*2
		Communication data size	1414 bytes*3
		Connection type	Point-to-point
	Transmission specifications	Data transmission speed	100 Mbps
		Communication mode	Full-duplex
		Transmission method	Base band
		Interface	RJ45 connector
		IP version	IPv4 is supported.
Maximum segment length		100 m (length between hub and node)*4	
Number of cascade connections		100BASE-TX 2 levels maximum*5	
Network topology		Star topology, line pology	
Hub*6		Hubs with 100BASE-TX ports*7 can be used.	
Connection cable*8		100BASE-TX Ethernet cable of category 5 or higher (STP cable)	
General-purpose Ethernet communication	Transmission specifications	Data transfer speed	100/10 Mbps
		Communication mode	Full-duplex or half-duplex*6
		Transmission method	Base band
		Interface	RJ45 connector
		Maximum segment length	100 m (length between hub and node)*4
		Number of cascade connections	100BASE-TX 2 levels maximum*5 10BASE-T 4 levels maximum*5
	Protocol type*9		MELSOFT connection, SLMP server (3E/1E frame), socket communication, simple CPU communication, BACnet/IP
	Number of connections		Total of 32 connections*10 (Up to 32 external devices can access one FX5-ENET/IP module at the same time.)
	Hub*6		Hubs with 100BASE-TX or 10BASE-T ports*11 can be used.
	Connection cable*8		100BASE-TX Ethernet cable of category 5 or higher (STP cable) 10BASE-T Ethernet cable of category 3 or higher (STP/UTP cable)
	Number of ports		2*12
Power supply		24 V DC, 110 mA (internal power supply)	
Compatible CPU module		FX5UJ: Compatible from initial product FX5U, FX5UC: Ver. 1.110 or later Connection with FX5UC CPU module requires connector conversion module (FX5-CNV-IFC) or extension power supply module (FX5-C1PS-5V).	
Number of occupied I/O points		8 points (Either input or output is available for counting.)	

\*1 : Class 3 communication supports the server functions.

\*2 : The total number of connections for Class 3 communications and UCMM communications is 32.

\*3 : This size is the maximum size which can be specified to 'Data length' of Class 1 communication input data area of the request command during the client operation.  
During the sever operation, since the FX5-ENET/IP automatically responds according to the request command received from the client, the maximum size is not prescribed.

\*4 : For maximum segment length (length between hubs), consult the manufacturer of the hub used.

\*5 : This number applies when a repeater hub is used. When using a switching hub, check the number of cascaded stages with the manufacturer of the hub to be used.

\*6 : IEEE802.3x flow control is not supported.

\*7 : The ports must comply with the IEEE802.3 100BASE-TX standards.

\*8 : A straight/cross cable can be used.

\*9 : For a compatible version of each protocol, refer to the following manual.

→ MELSEC iQ-F FX5-ENET User's Manual

\*10: The first device for MELSOFT connection is not included in the number of connections. (The second and the following devices are included.)

The CC-Link IE field network Basic is not included in the number of connections.

\*11: The ports must comply with the IEEE802.3 100BASE-TX or IEEE802.3 10BASE-T standards.

\*12: Since the IP address is shared by two ports, only one address can be set.



# General, Power Supply, Input/Output Specifications

## ● FX5-CCL-MS

Item	Specifications											
Compatible functions	Master station or intelligent device station											
CC-Link supported version	Ver. 2.00 and Ver. 1.10											
Transmission Speed	<ul style="list-style-type: none"> <li>Master station: 156 kbps/625 kbps/2.5 Mbps/5 Mbps/10 Mbps</li> <li>Intelligent device station: 156 kbps/625 kbps/2.5 Mbps/5 Mbps/10 Mbps/auto-tracking</li> </ul>											
Station number	<ul style="list-style-type: none"> <li>Master station: 0</li> <li>Intelligent device station: 1 to 64</li> </ul>											
Connectable station type (at the time of master station)	Remote I/O station, remote device station, and intelligent device station (local station and standby master station cannot be connected)											
Maximum overall cable length	1200 m (varies depending on transmission speed)											
Maximum number of connected stations (at the time of master station)	<ul style="list-style-type: none"> <li>■FX5UJ CPU module                             <ul style="list-style-type: none"> <li>Remote I/O stations: 6 maximum (The total number of I/O points of remote I/O station is 192 or less.)</li> <li>The total number of intelligent device stations + remote device stations: 8 maximum (The total number of I/O points of intelligent device station + remote device station is 256 or less.)</li> </ul> </li> <li>■FX5U/FX5UC CPU module*3                             <ul style="list-style-type: none"> <li>Remote I/O stations: 14 maximum (The total number of I/O points of remote I/O station is 448 or less.)</li> <li>The total number of remote device stations + intelligent device stations: 14 maximum (The total number of I/O points of intelligent device station + remote device station is 448 or less.)</li> </ul> </li> </ul>											
Number of occupied stations (at the time of intelligent device station)	1 to 4 stations											
Maximum number of link points per system*3	CC-Link Ver. 1	<ul style="list-style-type: none"> <li>■FX5UJ CPU module                             <ul style="list-style-type: none"> <li>Remote I/O (RX, RY): 448 points (remote I/O station: 192 points*1 + remote device stations and intelligent device stations: 256 points)</li> <li>Remote register (RWw): 32 points</li> <li>Remote register (RWr): 32 points</li> </ul> </li> <li>■FX5U/FX5UC CPU module*3                             <ul style="list-style-type: none"> <li>Remote I/O (RX, RY): 896 points (remote I/O station: 448 points*1 + remote device stations and intelligent device stations: 448 points)</li> <li>Remote register (RWw): 56 points</li> <li>Remote register (RWr): 56 points</li> </ul> </li> </ul>										
		CC-Link Ver. 2	<ul style="list-style-type: none"> <li>■FX5UJ CPU module                             <ul style="list-style-type: none"> <li>Remote I/O (RX, RY): 448 points (remote I/O station: 192 points*1 + remote device stations and intelligent device stations: 256 points)</li> <li>Remote register (RWw): 64 points</li> <li>Remote register (RWr): 64 points</li> </ul> </li> <li>■FX5U/FX5UC CPU module*3                             <ul style="list-style-type: none"> <li>Remote I/O (RX, RY): 896 points (remote I/O station: 448 points*1 + remote device stations and intelligent device stations: 448 points)</li> <li>Remote register (RWw): 112 points</li> <li>Remote register (RWr): 112 points</li> </ul> </li> </ul>									
Number of link points*3	Extended cyclic setting	Number of occupied stations	CC-Link Ver. 1		CC-Link Ver. 2							
					Single		Double		Quadruple		Octuple	
			Remote I/O	Remote register	Remote I/O	Remote register	Remote I/O	Remote register	Remote I/O	Remote register	Remote I/O	Remote register
			1 station occupied	RX, RY: 32 points (16 points)*2 RWw: 4 points RWr: 4 points	RX, RY: 32 points (16 points)*2 RWw: 4 points RWr: 4 points	RX, RY: 32 points (16 points)*2 RWw: 8 points RWr: 8 points	RX, RY: 64 points (80 points)*2 RWw: 8 points RWr: 8 points	RX, RY: 128 points (160 points)*2 RWw: 16 points RWr: 16 points	RX, RY: 256 points (304 points)*2 RWw: 32 points RWr: 32 points	RX, RY: 512 points (608 points)*2 RWw: 64 points RWr: 64 points	RX, RY: 1024 points (1228 points)*2 RWw: 128 points RWr: 128 points	RX, RY: 2048 points (2456 points)*2 RWw: 256 points RWr: 256 points
			2 station occupied	RX, RY: 64 points (48 points)*2 RWw: 8 points RWr: 8 points	RX, RY: 64 points (48 points)*2 RWw: 8 points RWr: 8 points	RX, RY: 128 points (160 points)*2 RWw: 16 points RWr: 16 points	RX, RY: 256 points (304 points)*2 RWw: 32 points RWr: 32 points	RX, RY: 512 points (608 points)*2 RWw: 64 points RWr: 64 points	RX, RY: 1024 points (1228 points)*2 RWw: 128 points RWr: 128 points	RX, RY: 2048 points (2456 points)*2 RWw: 256 points RWr: 256 points	RX, RY: 4096 points (4912 points)*2 RWw: 512 points RWr: 512 points	RX, RY: 8192 points (9824 points)*2 RWw: 1024 points RWr: 1024 points
3 station occupied	RX, RY: 96 points (80 points)*2 RWw: 12 points RWr: 12 points	RX, RY: 96 points (80 points)*2 RWw: 12 points RWr: 12 points	RX, RY: 192 points (240 points)*2 RWw: 24 points RWr: 24 points	RX, RY: 384 points (464 points)*2 RWw: 48 points RWr: 48 points	RX, RY: 768 points (928 points)*2 RWw: 96 points RWr: 96 points	RX, RY: 1536 points (1840 points)*2 RWw: 192 points RWr: 192 points	RX, RY: 3072 points (3680 points)*2 RWw: 384 points RWr: 384 points	RX, RY: 6144 points (7360 points)*2 RWw: 768 points RWr: 768 points	RX, RY: 12288 points (14720 points)*2 RWw: 1536 points RWr: 1536 points			
4 station occupied	RX, RY: 128 points (112 points)*2 RWw: 16 points RWr: 16 points	RX, RY: 128 points (112 points)*2 RWw: 16 points RWr: 16 points	RX, RY: 256 points (304 points)*2 RWw: 32 points RWr: 32 points	RX, RY: 512 points (608 points)*2 RWw: 64 points RWr: 64 points	RX, RY: 1024 points (1228 points)*2 RWw: 128 points RWr: 128 points	RX, RY: 2048 points (2456 points)*2 RWw: 256 points RWr: 256 points	RX, RY: 4096 points (4912 points)*2 RWw: 512 points RWr: 512 points	RX, RY: 8192 points (9824 points)*2 RWw: 1024 points RWr: 1024 points	RX, RY: 16384 points (19648 points)*2 RWw: 2048 points RWr: 2048 points			
Transmission cable	CC-Link Ver. 1.10 compatible CC-Link dedicated cable											
Compatible CPU module	FX5UJ: Compatible from initial product FX5U, FX5UC: Ver. 1.050 or later Connection with FX5UC CPU module requires connector conversion module (FX5-CNV-IFC) or extension power supply module (FX5-C1PS-5V).											
Communication method	Broadcast polling method											
Transmission format	HDLC compliant											
Error control system	CRC (X <sup>16</sup> + X <sup>12</sup> + X <sup>5</sup> + 1)											
Power supply	24 V DC +20%, -15% 100 mA (external power supply)											
Number of occupied I/O points	8 points (Either input or output is available for counting.)											

\* 1: The number of remote I/O points that can be used CPU module varies depending on the number of input/output points of the extension device.

For the limit of the number of I/O points, refer to the following manual.

→ MELSEC iQ-F FX5S/FX5UJ/FX5U/FX5UC User's Manual (Hardware)

\* 2: The numbers in parentheses are the points that can be used when the module is an intelligent device station.

\* 3: Number of links with FX5U/FX5UC CPU module Ver. 1.100 or later. GX Works3 Ver. 1.047Z or later required. For details on the number of links with FX5U/FX5UC CPU module earlier than Ver. 1.100, refer to the following manual.

→ MELSEC iQ-F FX5 User's Manual (CC-Link)

\* 4: Not applicable to the FX5UJ CPU module. For details, refer to the following manual.

→ MELSEC iQ-F FX5 User's Manual (CC-Link)

## ● FX5-CCLIEF

Item	Specifications									
Station type	Intelligent device station									
Station number	1 to 120 (sets by parameter or program)									
Communication speed	1 Gbps									
Network topology	Line topology, star topology (coexistence of line topology and star topology is also possible), and ring topology									
Maximum station-to-station distance	Max. 100 m (Conforming to ANSI/TIA/EIA-568-B (Category 5e))									
Cascade connection	Max. 20 stages									
Communication method	Token passing									
Maximum number of link points*1	RX	384 points, 48 bytes								
	RY	384 points, 48 bytes								
	RWw	1024 points, 2048 bytes*2								
	RWv	1024 points, 2048 bytes*2								
Compatible CPU module	FX5UJ: Compatible from initial product FX5U, FX5UC Ver. 1.030 or later. Connection with FX5UC CPU module requires connector conversion module (FX5-CNV-IFC) or extension power supply module (FX5-C1PS-5V).									
Power supply	5 V DC, 10 mA (internal power supply) 24 V DC, 230 mA (external power supply)									
Number of occupied I/O points	8 points (Either input or output is available for counting.)									

\* 1: The maximum number of link points that a master station can assign to one FX5-CCLIEF module.

\* 2: 256 points (512 bytes) when the mode of the master station is online (High-Speed Mode).

For the general specifications for each model, refer to each manual.



# General, Power Supply, Input/Output Specifications

## ● FX5-CCLGN-MS

Items		Specifications	
Station type		Master or local station	
Station number		<ul style="list-style-type: none"> <li>Master station: 0</li> <li>Local station: 1 to 120</li> </ul>	
Maximum number of link points per network		RX	16 K points (16384 points, 2 K bytes)
		RY	16 K points (16384 points, 2 K bytes)
		RWr	8 K points (8192 points, 16 K bytes)
		RWw	8 K points (8192 points, 16 K bytes)
Maximum number of link points per station*1		Master station	
		RX	8 K points (8192 points, 1 K bytes)
		RY	8 K points (8192 points, 1 K bytes)
		RWr	4 K points (4096 points, 8 K bytes)
		RWw	4 K points (4096 points, 8 K bytes)
		Local station	
		RX	16 K points (16384 points, 2 K bytes)
		RY	16 K points (16384 points, 2 K bytes)
Communication speed		1 Gbps, 100Mbps*2	
Minimum synchronization cycle		250.00 μs	
Authentication Class		Authentication Class B device	
Maximum number of connectable stations	When used as a master station	61*3	
	When used as a local station	121	
Station-based data assurance	When used as a master station	61*3	
	When used as a local station	121	
Connection cable		For details, refer to MELSEC iQ-F FX5 User's Manual (CC-Link IE TSN).	
Overall cable distance	Line topology	12000 m (when 121 stations are connected)	
	Others	Depends on the system configuration.	
Maximum station-to-station distance		100 m	
Network number setting range		1 to 239	
Network topology		Line topology, star topology (coexistence of line topology and star topology is also possible)	
Communication method		Time sharing method	
Transient transmission capacity		1920 bytes	
Compatible CPU module		FX5UJ: Ver. 1.040 or later FX5U, FX5UC: Ver. 1.210 or later Connection with FX5UC CPU module requires connector conversion module (FX5-CNV-IFC) or extension power supply module (FX5-C1PS-5V).	
Power supply		24 V DC 220 mA (external power supply)	
Number of occupied I/O points		8 (Either input or output is available for counting.)	

\*1: The maximum number of points for all link devices may not be used simultaneously depending on the number of device stations, or the number of points and assignments of the link devices that are set in the "Network Configuration Settings" of the "Basic Settings".

\*2: Supported by the FX5-CCLGN-MS Ver. 1.010 or later.

\*3: The maximum number of connectable stations (61) includes the master station. When connecting multiple master stations, such as the FX5-CCLGN-M and the FX5-40/80SSC-G, which use device station parameters for the CPU module, the total number of device stations must be less than or equal to the number of device station parameter files that can be saved in the CPU module. For details about the number of device station parameter files that can be saved in the CPU module, refer to the following manual.  
→ MELSEC iQ-F FX5 User's Manual (Application)

## ● FX5-ASL-M

Item	Specifications
Transmission clock	27.0 kHz
Maximum transmission distance (total extension distance)	200 m*1
Transmission system	DC power supply superimposed total frame/cyclic system
Connection type	Bus type (multi-drop method, T-branch method, tree branch method)
Transmission protocol	Dedicated protocol (AnyWireASLINK)
Error control	Checksum, double check method
Number of connected I/O points	<ul style="list-style-type: none"> <li>FX5UJ: Up to 216 points*2 (192 input points maximum/192 output points maximum)</li> <li>FX5U, FX5UC: Up to 448 points*2*3 (256 input points maximum/256 output points maximum)</li> </ul>
Number of connected remote modules	Up to 128 modules (the number varies depending on the current consumption of each remote module)
External interface	7-piece spring clamp terminal block push-in type
RAS function	<ul style="list-style-type: none"> <li>Transmission line disconnection position detection function</li> <li>Transmission line short-circuit detection function</li> <li>Transmission power drop detection function</li> </ul>
Transmission line (DP, DN)	<ul style="list-style-type: none"> <li>UL-compliant general-purpose 2-wire cable</li> <li>UL-compliant general-purpose cable</li> <li>For dedicated flat cables</li> </ul>
Memory	Built-in memory EEPROM (rewrite endurance: 100 thousand times)
Compatible CPU module	FX5UJ: Compatible from initial product FX5U, FX5UC: Ver. 1.050 or later Connection with FX5UC CPU module requires connector conversion module (FX5-CNV-IFC) or extension power supply module (FX5-C1PS-5V).
Power supply	5 V DC, 200 mA (internal power supply) 24 V DC +15%, -10% 100 mA (external power supply)
Number of occupied I/O points	8 (Either input or output is available for counting.)

\*1: For the remote module in which the transmission line (DP, DN) and module body are integrated, the length of the transmission line (DP, DN) is also included in the total extension. When laying a 4-wire (DP, DN, 24 V, 0 V) line for fifty meters or more, insert a power line noise filter between the power supply and the line. For details, refer to the manual of ASLINK filter (ANF-01) made by Anywire Corporation.

\*2: The number of remote I/O points that can be used CPU module varies depending on the number of input/output points of the extension device. For the limit of the number of I/O points, refer to the following manual.  
→ MELSEC iQ-F FX5S/FX5UJ/FX5U/FX5UC User's Manual (Hardware)

\*3: Supported by FX5U/FX5UC CPU module Ver. 1.100 or later and by GX Works3 Ver. 1.047Z or later.

For the general specifications for each model, refer to each manual.

# General, Power Supply, Input/Output Specifications

## ● FX5-DP-M

Items		Specifications
PROFIBUS-DP station type		Class 1 master station
Transmission specifications	Electrical standard and characteristics	Compliant with EIA-RS485
	Medium	Shielded twisted pair cable
	Network configuration	Bus topology (or tree topology when repeaters are used)
	Data link method	Between DP-Masters: Token passing Between DP-Master and DP-Slave: Polling
	Encoding method	NRZ
	Transmission speed*1	9.6 kbps, 19.2 kbps, 93.75 kbps, 187.5 kbps, 500 kbps, 1.5 Mbps, 3 Mbps, 6 Mbps, 12 Mbps
	Transmission distance	Differs depending on transmission speed*2
	Maximum number of repeaters (Between DP-Master and DP-Slave)	3 repeaters
	Number of connectable modules (per segment)	32 per segment (including repeaters)
	Maximum number of DP-Slaves	64 modules*3
Number of connectable nodes (number of repeaters)	32, 62 (1), 92 (2), 122 (3), 126 (4)	
Transmittable data	Input data	Max. of 2048 bytes (Max. of 244 bytes per DP-Slave)
	Output data	Max. of 2048 bytes (Max. of 244 bytes per DP-Slave)
Power supply		24 V DC, 150 mA (internal power supply)
Compatible CPU module		FX5UJ: Compatible from initial product FX5U, FX5UC: Ver. 1.110 or later Connection with FX5UC CPU module requires connector conversion module (FX5-CNV-IFC) or extension power supply module (FX5-C1PS-5V).
Number of occupied I/O points		8 points (Either input or output is available for counting.)

\*1: Transmission speed accuracy is within  $\pm 0.2\%$  (compliant with IEC61158-2).

\*2: For details on the transmission distance, refer to the manual.

\*3: For details on the PROFIBUS-DP network configuration, refer to the manual.

## ● FX5-OPC

Items		Specifications	
OPC UA server	OPC UA version	1.03	
	Profile	Micro Embedded Device Server Profile For details, refer to the manual.	
	Service	For details, refer to the manual.	
	Address space	For details, refer to the manual.	
	User authentication	User name and password	
	Maximum number of parallel sessions	4	
	Maximum number of subscriptions per session	2	
	Maximum number of monitored items per subscription	500	
	Minimum sampling interval of a monitored item	100 ms	
	Maximum number of trusted certificates	10	
Time information	For details, refer to the manual.		
Network topology	Star topology		
Ethernet	Transmission specifications	Data transmission speed	100/10 Mbps
		Communication mode	Full-duplex or half-duplex*1
		Transmission method	Base band
		Interface	RJ45 connector
		Maximum segment length	100 m*2
	Number of cascade connections	100BASE-TX	2 levels maximum*3
		10BASE-T	4 levels maximum*3
Hub*1	Hubs with 100BASE-TX or 10BASE-T ports*4 can be used.		
Connection cable*5	100BASE-TX, 10BASE-T		
Number of ports	2		
Number of occupied I/O points		8 points	
Power supply		24 V DC, 110 mA (internal power supply)	
Compatible CPU module		FX5U, FX5UC: Ver. 1.245 or later Connection with FX5UC CPU module requires connector conversion module (FX5-CNV-IFC) or extension power supply module (FX5-C1PS-5V).	

1: IEEE802.3x flow control is not supported.

2: For maximum segment length (length between hubs), consult the manufacturer of the hub used.

3: This number applies when a repeater hub is used. When using a switching hub, check the number of cascaded stages with the manufacturer of the hub to be used.

4: The ports must comply with the IEEE802.3 100BASE-TX or IEEE802.3 10BASE-T standards.

5: A straight/cross cable can be used.

For the general specifications for each model, refer to each manual.

## ◇ Simple motion module

- FX5-40SSC-S
- FX5-80SSC-S

### Control specification

Item		Specifications	
		FX5-40SSC-S	FX5-80SSC-S
Number of control axes (Virtual servo amplifier axis included)		Max. 4 axes	Max. 8 axes
Operation cycle (Operation cycle settings) [ms]		0.888/1.777	
Interpolation function		Linear interpolation (up to 4-axis, 2-axis circular interpolation)	
Control system		PTP (Point To Point) control, Trajectory control (both linear and arc), Speed control, Speed-position switching control, Position-speed switching control, Speed-torque control	
Acceleration/deceleration process		Trapezoidal acceleration/deceleration, S-curve acceleration/deceleration	
Compensation function		Backlash compensation, Electronic gear, Near pass function	
Synchronous control	Input axis	Servo input axis, synchronous encoder axis, command generation axis	
	Output axis	Cam shaft	
Cam control	Number of registered cams*1	Up to 64 cams	Up to 128 cams
	Cam data format	Stroke ratio data format, coordinate data format	
	Automatic generation of cam	Automatic generation of cam for rotary cutter	
Control unit		mm, inch, degree, pulse	
Number of positioning data		600 data (positioning data No. 1 to 600)/axis (Can be set with MELSOFT GX Works3 or a sequence program.)	
Backup		Parameters, positioning data, and block start data can be saved on flash ROM (battery-less backup)	
Home position return	Home position return method	Proximity dog method, Count method 1, Count method 2, Data set method, Scale home position signal detection method, Driver home position return method	
	Fast home position return control	Provided	
	Auxiliary functions	Home position return retry, Home position shift	
Positioning control	Linear control	Linear interpolation control (Up to 4 axes)*2 (Vector speed, Reference axis speed)	
	Fixed-pitch feed control	Fixed-pitch feed control (Up to 4 axes)	
	2-axis circular interpolation	Auxiliary point-specified circular interpolation, Central point-specified circular interpolation	
	Speed control	Speed control (Up to 4 axes)	
	Speed-position switching control	INC mode, ABS mode	
	Position-speed switching control	INC mode	
	Current value change	Positioning data, Start No. for a current value changing	
	NOP instruction	Provided	
	JUMP instruction	Unconditional JUMP, Conditional JUMP	
	LOOP, LEND	Provided	
	High-level positioning control	Block start, Condition start, Wait start, Simultaneous start, Repeated start	
	Manual control	JOG operation	Provided
Inching operation		Provided	
Manual pulse generator		Possible to connect 1 module (Incremental), Unit magnification (1 to 10000 times)	

Item		Specifications	
		FX5-40SSC-S	FX5-80SSC-S
Expansion control	Speed-torque control	Speed control without positioning loops, Torque control, Tightening & press-fit control	
	Absolute position system	Provided	
Synchronous encoder interface		Up to 4 channels (Total of the internal interface, via PLC CPU interface, and servo amplifier interface)	
Internal interface		1 ch (Incremental)	
Functions that limit control	Speed limit function	Speed limit value, JOG speed limit value	
	Torque limit function	Torque limit value same setting, torque limit value individual setting	
	Forced stop	Valid/Invalid setting	
	Software stroke limit function	Movable range check with current feed value, movable range check with machine feed value	
	Hardware stroke limit function	Provided	
Functions that change control details	Speed change function	Provided	
	Override function	1 to 300 [%]	
	Acceleration/deceleration time change function	Provided	
	Torque change function	Provided	
Other functions	Target position change function	Target position address and speed are changeable	
	M-code output function	Provided	
	Step function	Deceleration unit step, Data No. unit step	
	Skip function	Via PLC CPU, Via external command signal	
Teaching function		Provided	
Parameter initialization function		Provided	
External input signal setting function		Via CPU, Via servo amplifier	
Amplifier-less operation function		Provided	
Mark detection function	Mark detection signal		Up to 4 points
	Mark detection setting		16 settings
	Optional data monitor function		Up to 4 points/axis
Driver communication function		Provided	
SSCNET connect/disconnect function		Provided	
Digital oscilloscope function*3	Bit data	16 ch	
	Word data	16 ch	

\*1: The number of registered cams varies depending on the memory capacity, cam resolution, and the number of coordinates.

\*2: 4-axis linear interpolation control is enabled only at the reference axis speed.

\*3: 8 ch word data and 8 ch bit data can be displayed in real time.

# General, Power Supply, Input/Output Specifications

## Module specification

Item	Specifications	
	FX5-40SSC-S	FX5-80SSC-S
Number of control axes	Max. 4 axes	Max. 8 axes
Servo amplifier connection method	SSCNET III/H	
Maximum overall cable distance [m]	400	800
Maximum distance between stations [m]	100	
Peripheral I/F	Via CPU module (Ethernet)	
Manual pulse generator operation function	Possible to connect 1 module	
Synchronous encoder operation function	Possible to connect 4 modules (Total of the internal interface, via PLC CPU interface, and servo amplifier interface)	
Input signals (DI)	No. of input points	4 points
	Input method	Positive common/Negative common shared (Photocoupler)
	Rated input voltage/current	24 V DC/Approx. 5 mA
	Operating voltage range	19.2 to 26.4 V DC (24 V DC +10%/-20%, ripple ratio 5% or less)
	ON voltage/current	17.5 V DC or more/3.5 mA or more
	OFF voltage/current	7 V DC or less/1.0 mA or less
	Input resistance	Approx. 6.8 kΩ
	Response time	1 ms or less (OFF→ON, ON→OFF)
	Recommended wire size	AWG24 (0.2 mm <sup>2</sup> )
Forced stop input signal (EMI)	No. of input points	1 point
	Input method	Positive common/Negative common shared (Photocoupler)
	Rated input voltage/current	24 V DC/Approx. 5 mA
	Operating voltage range	19.2 to 26.4 V DC (24 V DC +10%/-20%, ripple ratio 5% or less)
	ON voltage/current	17.5 V DC or more/3.5 mA or more
	OFF voltage/current	7 V DC or less/1.0 mA or less
	Input resistance	Approx. 6.8 kΩ
	Response time	4 ms or less (OFF→ON, ON→OFF)
	Recommended wire size	AWG24 (0.2 mm <sup>2</sup> )

Item	Specifications		
	FX5-40SSC-S	FX5-80SSC-S	
Signal input form	Phase A/Phase B (magnification by 4/magnification by 2/magnification by 1), PULSE/SIGN		
	Differential output type (26LS31 or equivalent)	Input pulse frequency	Max. 1 Mpulse/s (After magnification by 4, up to 4 Mpulse/s)
		Pulse width	1 μs or more
		Leading edge/trailing edge time	0.25 μs or less
		Phase difference	0.25 μs or more
		Rated input voltage	5.5 V DC or less
		High/Low-voltage	2.0 to 5.25 V DC/0 to 0.8 V DC
		Differential voltage	±0.2 V
		Cable length	Up to 30 m
		Manual pulse generator / Incremental synchronous encoder signal	Input pulse frequency
Pulse width	5 μs or more		
Leading edge/trailing edge time	1.2 μs or less		
Phase difference	1.2 μs or more		
Rated input voltage	5.5 V DC or less		
High/Low-voltage	3.0 to 5.25 V DC/2 mA or less, 0 to 1.0 V DC/5 mA or more		
Cable length	Up to 10 m		
Voltageoutput/ Opencollector type (5 V DC)	FX5UJ, FX5U, FX5UC: Compatible from initial product Only 1 module may be connected per system. Connection with FX5UC CPU module requires connector conversion module (FX5-CNV-IFC) or extension power supply module (FX5-C1PS-5V).		
	Compatible CPU module		
	Number of occupied input/output points		
Power supply		24 V DC +20%/-15% (external power supply)	

## ◇ Motion module

- FX5-40SSC-G
- FX5-80SSC-G

### Control specification

Item		Specifications		
		FX5-40SSC-G	FX5-80SSC-G	
Number of control axes (Virtual servo amplifier axis included)		Max. 4 axes	Max. 8 axes	
Operation cycle (Operation cycle settings) [ms]		0.500/1.000/2.000/4.000		
Interpolation function		Linear interpolation (up to 4-axis, 2-axis circular interpolation)		
Control system		PTP (Point To Point) control, Trajectory control (both linear and arc), Speed control, Speed-position switching control, Position-speed switching control, Speed-torque control		
Acceleration/deceleration process		Trapezoidal acceleration/deceleration, S-curve acceleration/deceleration		
Compensation function		Backlash compensation, Electronic gear, Near pass function		
Synchronous control		Synchronous encoder input, command generation axis, cam, phase compensation, cam auto-generation		
Cam control	Number of registered cams*1	Up to 128 cams		
	Cam data format	Stroke ratio data format, coordinate data format		
	Automatic generation of cam	Automatic generation of cam for rotary cutter		
Control unit		mm, inch, degree, pulse		
Number of positioning data		600 data (positioning data No. 1 to 600)/axis (Can be set with MELSOFT GX Works3 or a sequence program.)		
Backup		Parameters, positioning data, and block start data can be saved on flash ROM (battery-less backup)		
Home position return		Driver home position return method		
Positioning control	Linear control	Linear interpolation control (Up to 4 axes)*2 (Vector speed, Reference axis speed)		
	Fixed-pitch feed control	Fixed-pitch feed control (Up to 4 axes)		
	2-axis circular interpolation	Auxiliary point-specified circular interpolation, Central point-specified circular interpolation		
	Speed control	Speed control (Up to 4 axes)		
	Speed-position switching control	INC mode, ABS mode		
	Position-speed switching control	INC mode		
	Current value change	Positioning data, Start No. for a current value changing		
	NOP instruction	Provided		
	JUMP instruction	Unconditional JUMP, Conditional JUMP		
	LOOP, LEND	Provided		
	High-level positioning control	Block start, Condition start, Wait start, Simultaneous start, Repeated start		
	Manual control	JOG operation	Provided	
		Inching operation	Provided	
Manual pulse generator		Possible to connect 1 module (Incremental), Unit magnification (1 to 10000 times)		
Expansion control	Speed-torque control	Speed control without positioning loops, Torque control, Tightening & press-fit control		
Absolute position system		Made compatible by setting a battery to servo amplifier		
Synchronous encoder interface		Up to 4 channels (Total of the, via PLC CPU interface, and servo amplifier interface)		
Functions that limit control	Speed limit function	Speed limit value, JOG speed limit value		
	Torque limit function	Torque limit value same setting, torque limit value individual setting		
	Forced stop	Via buffer memory, Valid/Invalid setting		
	Software stroke limit function	Movable range check with current feed value, movable range check with machine feed value		
	Hardware stroke limit function	Provided		
Functions that change control details	Speed change function	Provided		
	Override function	1 to 300 [%]		
	Acceleration/deceleration time change function	Provided		
	Torque change function	Provided		
	Target position change function	Target position address and speed are changeable		
Other functions	M-code output function	Provided		
	Step function	Deceleration unit step, Data No. unit step		
	Skip function	Via PLC CPU, Via external command signal		
	Teaching function	Provided		
Parameter initialization function		Provided		
External input signal setting function		Via CPU, Via servo amplifier		

Item		Specifications	
		FX5-40SSC-G	FX5-80SSC-G
Mark detection function		Continuous Detection mode, Specified Number of Detections mode, Ring Buffer mode	
	Mark detection signal	Signals for the number of axes of the connected servo amplifiers	
	Mark detection setting	16 settings	
Optional data monitor function		Up to 4 points/axis	
Event history function		Provided	
Servo transient transmission function		Provided	
Digital oscilloscope function*3	Bit data	16 ch	
	Word data	16 ch	

\*1: The number of registered cams varies depending on the memory capacity, cam resolution, and the number of coordinates.

\*2: 4-axis linear interpolation control is enabled only at the reference axis speed.

\*3: 8 ch word data and 8 ch bit data can be displayed in real time.

### Module specification

Item		Specifications	
		FX5-40SSC-G	FX5-80SSC-G
Communication speed		1 Gbps	
Maximum number of connectable stations per network		Motion control stations: 4 Standard stations: 16	Motion control stations: 8 Standard stations: 16
Communication cable		Ethernet cable (Category 5e or higher, straight cable (double-shielded, STP))	
Maximum station-to-station distance		100 m	
Maximum number of networks		239	
Network topology*		Line topology, star topology (Coexistence of line topology and star topology is also possible.)	
Communication method		Time sharing method	
Transient transmission capacity		1920 bytes	
Maximum number of link points per network	RX/RX	8192 points, 1K bytes (When used as a master station)	
	RW/RW	1024 points, 2K bytes (When used as a master station)	
Maximum number of link points per station	RX/RX	8192 points, 1K bytes (When used as a master station)	
	RW/RW	1024 points, 2K bytes (When used as a master station)	
Compatible CPU module		FX5U, FX5UC: Ver. 1.230 or later Connection with FX5UC CPU module requires connector conversion module (FX5-CNV-IFC) or extension power supply module (FX5-C1PS-5V).	
Number of occupied input/output points		8 points (Either input or output is available for counting.)	
Power supply		24 V DC +20%/-15% (external power supply)	

\*: Use a switching hub (certified class: B) for star topology.

# External Dimensions

Unit: mm

CPU module

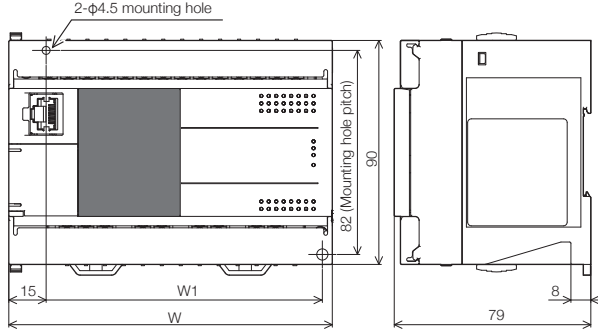

- External color: Main body, Munsell 0.6B7.6/0.2

Model	W: mm	W1: mm Mounting hole pitches	MASS (Weight): kg
FX5S-30M□	100	81	Approx. 0.45
FX5S-40M□	130	111	Approx. 0.55
FX5S-60M□	175	156	Approx. 0.65

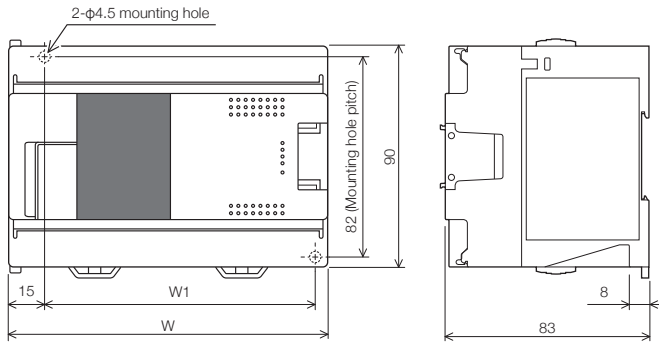

- External color: Main body, Munsell 0.6B7.6/0.2

Model	W: mm	W1: mm Mounting hole pitches	MASS (Weight): kg
FX5UJ-24M□	95	76	Approx. 0.55
FX5UJ-40M□	130	111	Approx. 0.65
FX5UJ-60M□	175	156	Approx. 0.80

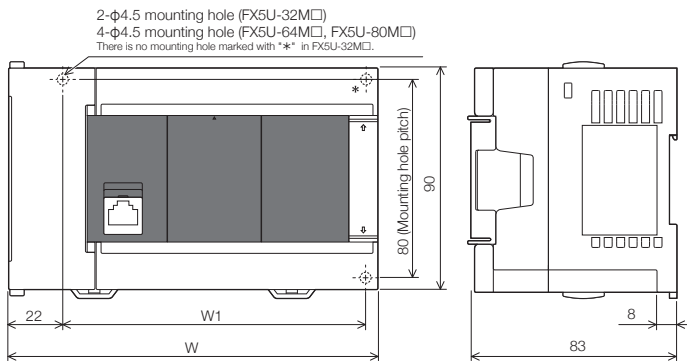

- External color: Main body, Munsell 0.6B7.6/0.2

Model	W: mm	W1: mm Mounting hole pitches	MASS (Weight): kg
FX5U-32MR/ES, FX5U-32MT/ES, FX5U-32MT/ESS FX5U-32MR/DS, FX5U-32MT/DS, FX5U-32MT/DSS	150	123	Approx. 0.7
FX5U-64MR/ES, FX5U-64MT/ES, FX5U-64MT/ESS FX5U-64MR/DS, FX5U-64MT/DS, FX5U-64MT/DSS	220	193	Approx. 1.0
FX5U-80MR/ES, FX5U-80MT/ES, FX5U-80MT/ESS FX5U-80MR/DS, FX5U-80MT/DS, FX5U-80MT/DSS	285	258	Approx. 1.2

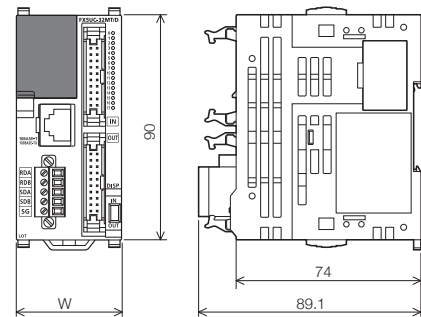

- External color: Main body, Munsell 0.6B7.6/0.2  
- Accessories: FX2NC-100MPCB type power cable  
FX2NC-100BPCB type power cable (FX5UC-□MT/D only)

Model	W: mm	MASS (Weight): kg
FX5UC-32MT/D, FX5UC-32MT/DSS	42.1	Approx. 0.2
FX5UC-64MT/D, FX5UC-64MT/DSS	62.2	Approx. 0.3
FX5UC-96MT/D, FX5UC-96MT/DSS	82.3	Approx. 0.35

# External Dimensions

Unit: mm

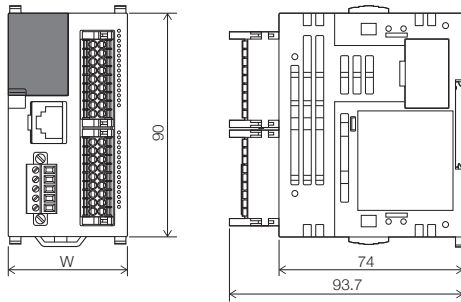

- External color: Main body, Munsell 0.6B7.6/0.2
- Accessories: FX2NC-100MPCB type power cable

Model	W: mm	MASS (Weight): kg
FX5UC-32MT/DS-TS, FX5UC-32MT/DSS-TS	48.1	Approx. 0.25
FX5UC-32MR/DS-TS	68.2	Approx. 0.35

## Safety extension module

### Safety main module

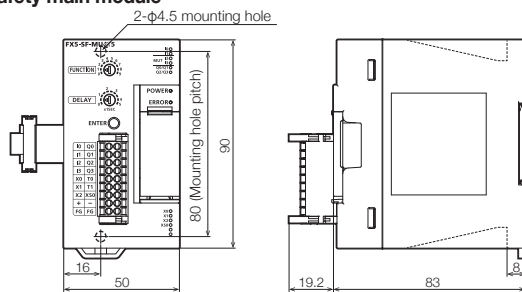

- External color: Munsell 0.6B7.6/0.2

Model	MASS (Weight): kg
FX5-SF-MU4T5	Approx. 0.3

### Safety input expansion module

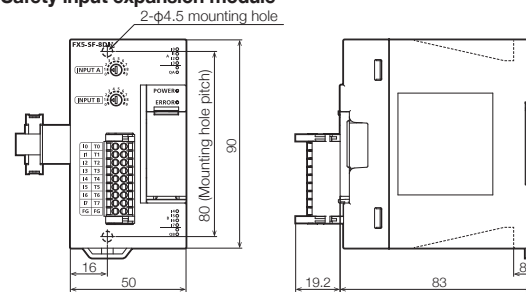

- External color: Munsell 0.6B7.6/0.2

Model	MASS (Weight): kg
FX5-SF-8DI4	Approx. 0.25

# External Dimensions

Unit: mm

## I/O module

### Input module/output module (extension cable type), high-speed pulse input/output module

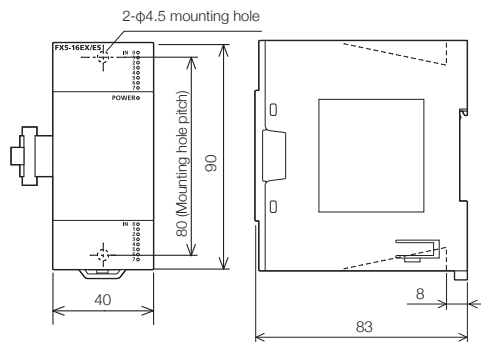

- External color: Munsell 0.6B7.6/0.2

Model	MASS (Weight): kg
FX5-8EX/ES, FX5-8EYR/ES, FX5-8EYT/ES, FX5-8EYT/ESS	Approx. 0.2
FX5-16EX/ES, FX5-16EYR/ES, FX5-16EYT/ES, FX5-16EYT/ESS, FX5-16ER/ES, FX5-16ET/ES, FX5-16ET/ESS, FX5-16ET/ES-H, FX5-16ET/ESS-H	Approx. 0.25

### Powered input/output module

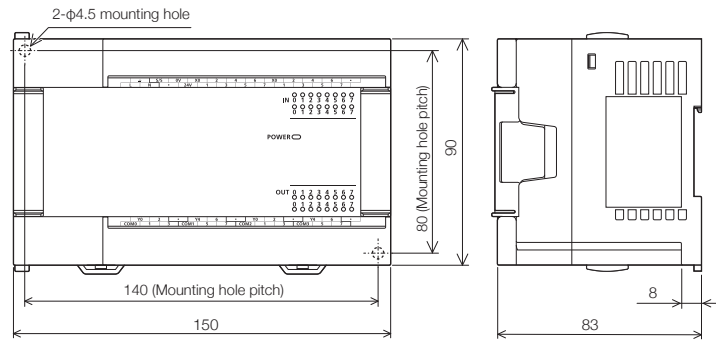

- External color: Munsell 0.6B7.6/0.2  
- Accessories: Extension cable

Model	MASS (Weight): kg
FX5-32ER/ES, FX5-32ET/ES, FX5-32ET/ESS, FX5-32ER/DS, FX5-32ET/DS, FX5-32ET/DSS	Approx. 0.65

### Input module/output module (extension connector type)

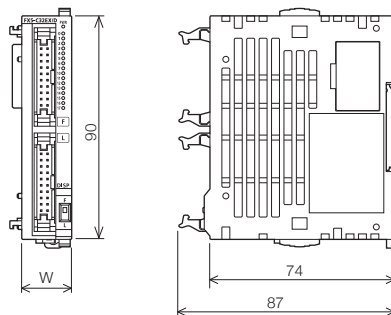

- External color: Munsell 0.6B7.6/0.2

Model	W: mm	MASS (Weight): kg
FX5-C16EX/D, FX5-C16EX/DS, FX5-C16EYT/D, FX5-C16EYT/DSS	14.6	Approx. 0.1
FX5-C32EX/D, FX5-C32EX/DS, FX5-C32EYT/D, FX5-C32EYT/DSS	20.1	Approx. 0.15

### Input/output module (extension connector type)

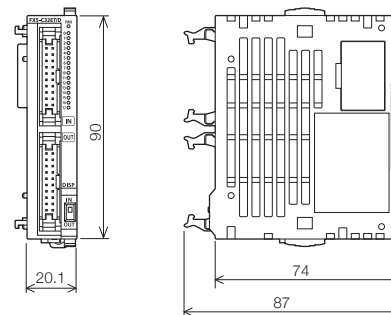

- External color: Munsell 0.6B7.6/0.2

Model	MASS (Weight): kg
FX5-C32ET/D, FX5-C32ET/DSS	Approx. 0.15

### Input module/output module/Input/output module (Spring clamp terminal block type)

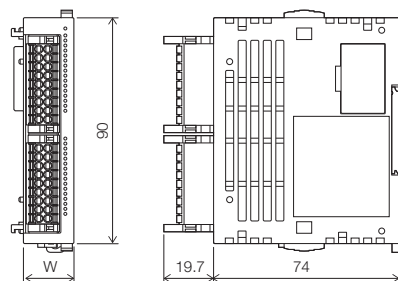

- External color: Main body, Munsell 0.6B7.6/0.2

Model	W: mm	MASS (Weight): kg
FX5-C16EYR/D-TS	30.7	Approx. 0.2
FX5-C32EX/DS-TS, FX5-C32EYT/D-TS, FX5-C32EYT/DSS-TS, FX5-C32ET/DS-TS, FX5-C32ET/DSS-TS	20.1	Approx. 0.15



# External Dimensions

Unit: mm

## Intelligent function module

### FX5-40SSC-S/FX5-80SSC-S FX5-40SSC-G/FX5-80SSC-G

- MASS (Weight): Approx. 0.3 kg  
- External color: Munsell 0.6B7.6/0.2

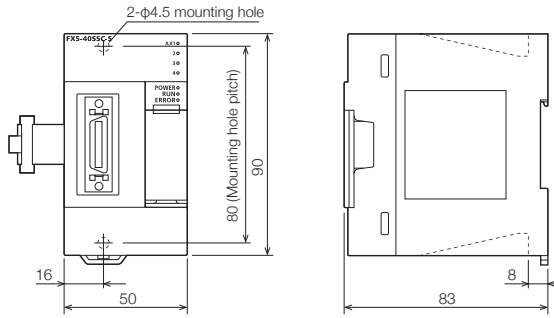

### FX5-4AD/FX5-4DA

- MASS (Weight): Approx. 0.2 kg  
- External color: Munsell 0.6B7.6/0.2

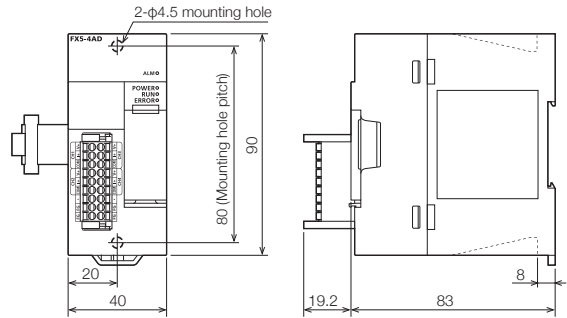

### FX5-8AD

- MASS (Weight): Approx. 0.3 kg  
- External color: Munsell 0.6B7.6/0.2

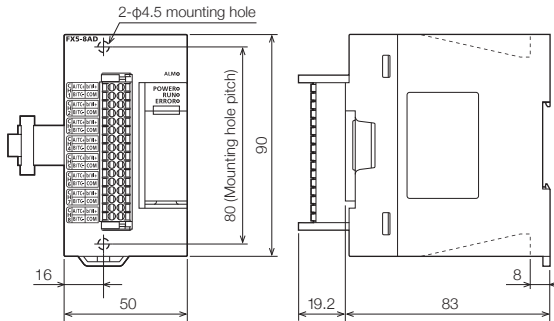

### FX5-4LC

- MASS (Weight): Approx. 0.3 kg  
- External color: Munsell 0.6B7.6/0.2

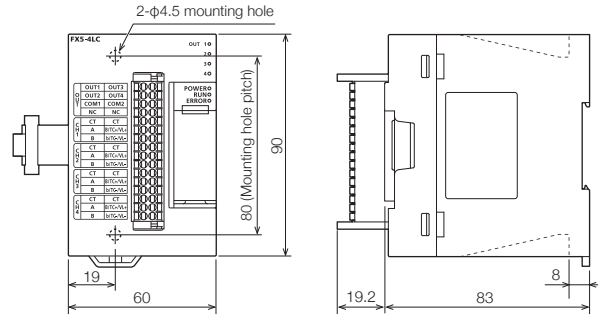

### FX5-20PG-P/FX5-20PG-D

- MASS (Weight): Approx. 0.2 kg  
- External color: Munsell 0.6B7.6/0.2

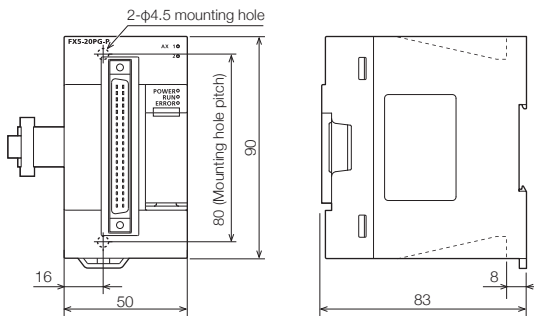

### FX5-CCL-MS

- MASS (Weight): Approx. 0.3 kg  
- External color: Munsell 0.6B7.6/0.2

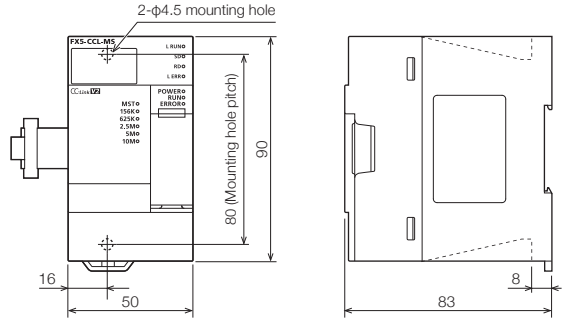

### FX5-CCLIEF

- MASS (Weight): Approx. 0.3 kg  
- External color: Munsell 0.6B7.6/0.2

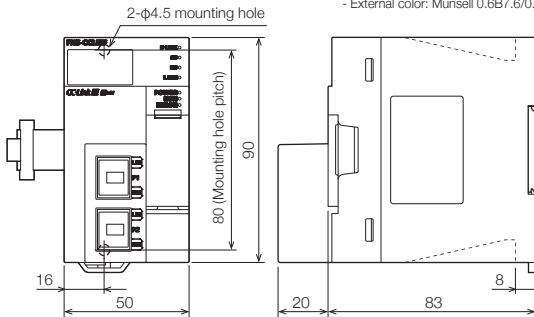

### FX5-CCLGN-MS

- MASS (Weight): Approx. 0.3 kg  
- External color: Munsell 0.6B7.6/0.2

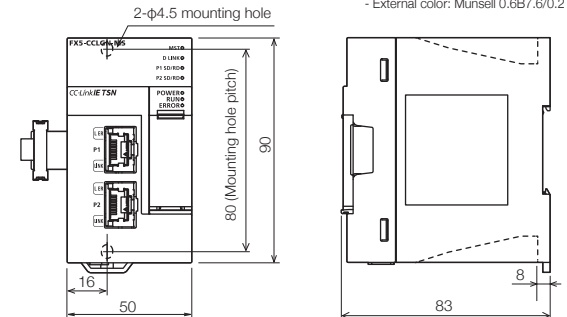

# External Dimensions

Unit: mm

## FX5-ASL-M

- MASS (Weight): Approx. 0.2 kg  
- External color: Munsell 0.6B7.6/0.2

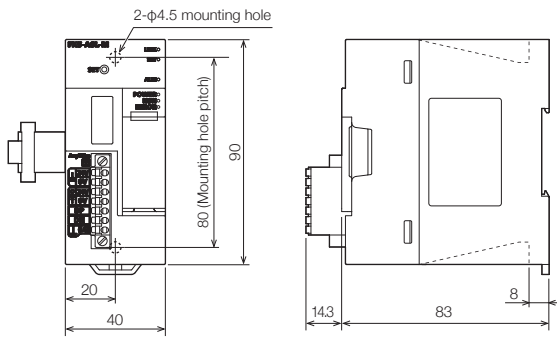

## FX5-DP-M

- MASS (Weight): Approx. 0.2 kg  
- External color: Munsell 0.6B7.6/0.2

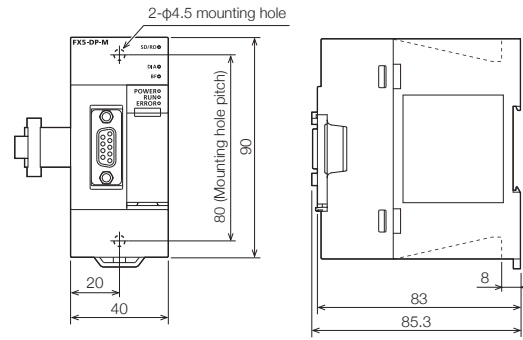

## FX5-ENET

- MASS (Weight): Approx. 0.2 kg  
- External color: Munsell 0.6B7.6/0.2

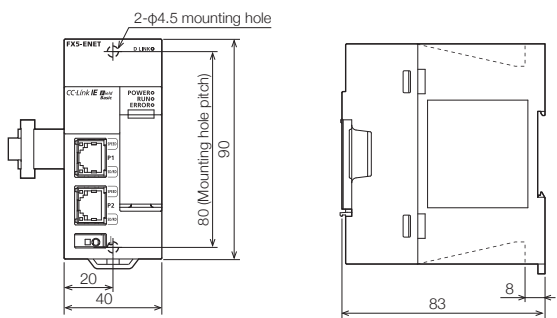

## FX5-ENET/IP

- MASS (Weight): Approx. 0.2 kg  
- External color: Munsell 0.6B7.6/0.2

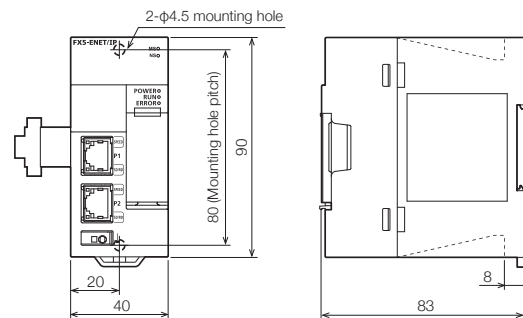

## FX5-OPC

- MASS (Weight): Approx. 0.2 kg  
- External color: Munsell 0.6B7.6/0.2

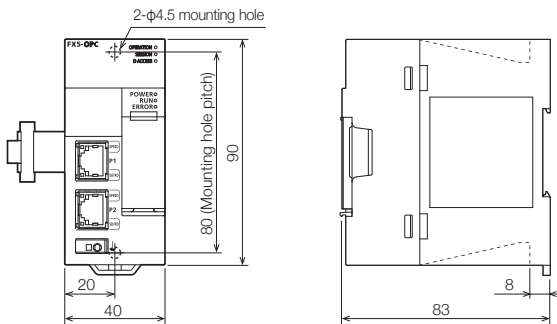

## Expansion adapter

### FX5-4A-ADP/FX5-4AD-ADP FX5-4DA-ADP/FX5-4AD-PT-ADP FX5-4AD-TC-ADP

- MASS (Weight): Approx. 0.1 kg  
- External color: Munsell 0.6B7.6/0.2

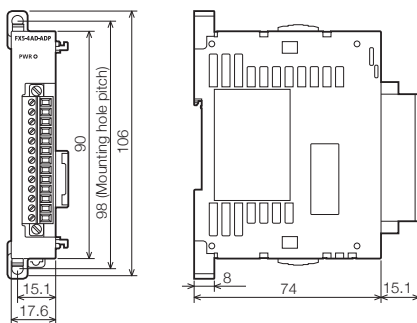

### FX5-232ADP/FX5-485ADP

- MASS (Weight): Approx. 0.08 kg  
- External color: Munsell 0.6B7.6/0.2

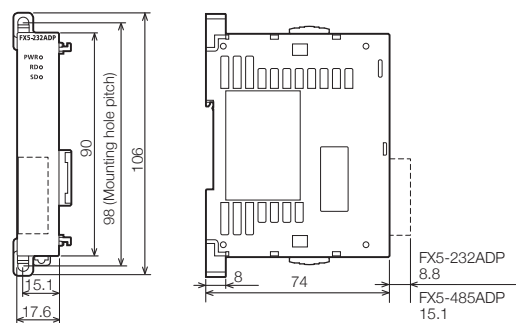

FX5-232ADP 8.8  
FX5-485ADP 15.1

# External Dimensions

Unit: mm

## Expansion board

**FX5-232-BD**

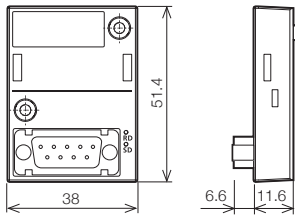

**FX5-485-BD**

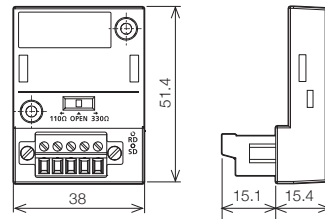

- MASS (Weight):  
Approx. 0.02 kg  
- External color: Munsell N1.5

**FX5-422-BD-GOT**

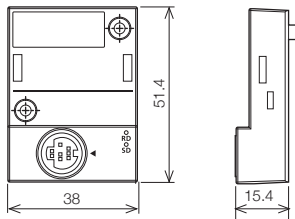

**FX5-SDCD**

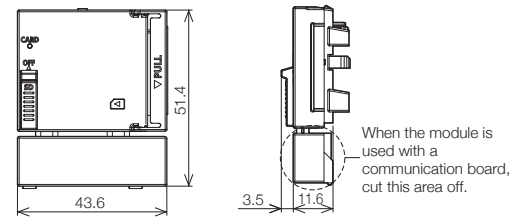

## Bus conversion module

**FX5-CNV-BUS**

- MASS (Weight): Approx. 0.1 kg  
- External color: Munsell 0.6B7.6/0.2

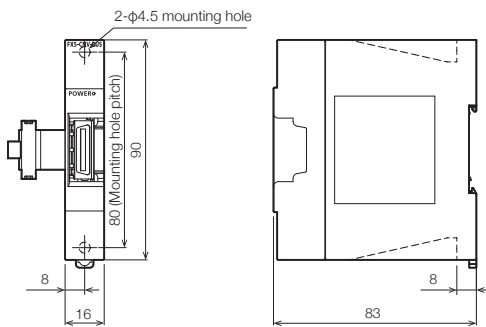

**FX5-CNV-BUSC**

- MASS (Weight): Approx. 0.1 kg  
- External color: Munsell 0.6B7.6/0.2

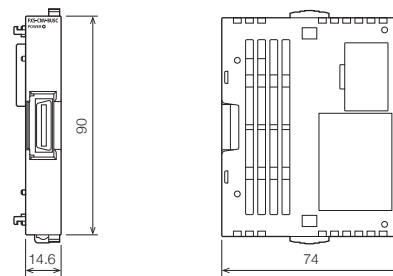

## Connector conversion module

**FX5-CNV-IF**

- MASS (Weight): Approx. 0.06 kg  
- External color: Munsell 0.6B7.6/0.2  
- Accessory: Extension cable

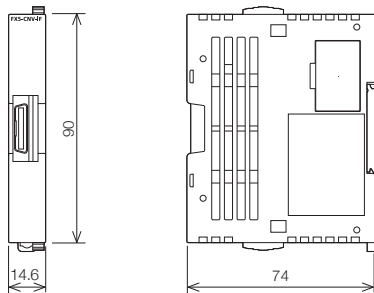

**FX5-CNV-IFC**

- MASS (Weight): Approx. 0.06 kg  
- External color: Munsell 0.6B7.6/0.2

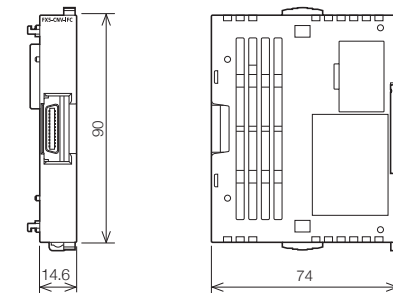

# External Dimensions

Unit: mm

## Connector conversion adapter

### FX5-CNV-BC

- MASS (Weight): Approx. 0.04 kg
- External color: Munsell 0.08GY7.64/0.81

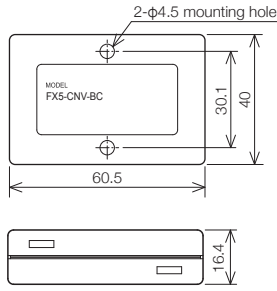

## FX5 extension power supply module

### FX5-1PSU-5V

- MASS (Weight): Approx. 0.3 kg
- External color: Munsell 0.6B7.6/0.2
- Accessories: Extension cable
- M3 terminal screw for terminal block
- DIN rail of 35 mm in width can be installed

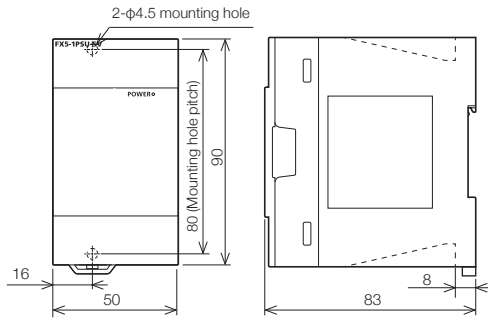

### FX5-C1PS-5V

- MASS (Weight): Approx. 0.1 kg
- External color: Munsell 0.6B7.6/0.2

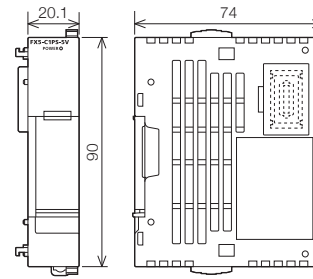

## FX3 extension power supply module

### FX3U-1PSU-5V

- MASS (Weight): Approx. 0.3 kg
- External color: Munsell 0.08GY7.64/0.81
- Accessories: Extension cable
- M3 terminal screw for terminal block
- DIN rail of 35 mm in width can be installed

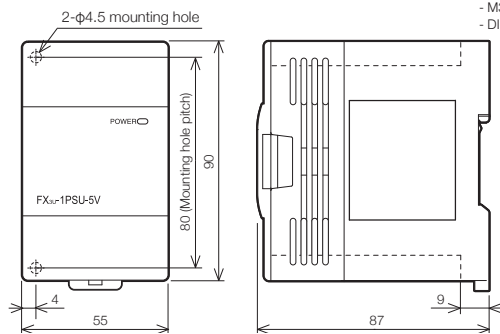

## FX3 intelligent function module

### FX3U-4AD/FX3U-4DA

### FX3U-64CCL/FX3U-16CCL-M

- External color: Munsell 0.08GY/7.64/0.81
- Accessories: Special block No. label, dust sheet, and terminating resistor\*
- M3 terminal screw for terminal block
- DIN rail of 35 mm in width can be installed
- \*: Attached only to FX3U-16CCL-M

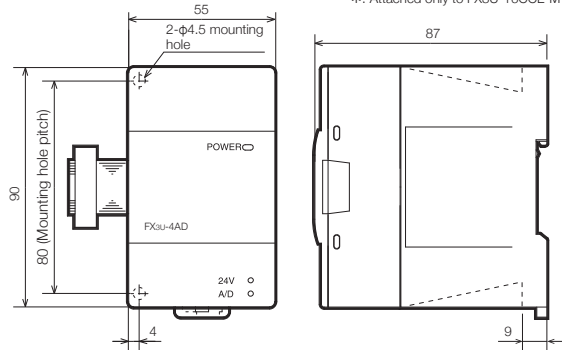

Model	MASS (Weight): kg
FX3U-4AD, FX3U-4DA	Approx. 0.2
FX3U-64CCL, FX3U-16CCL-M	Approx. 0.3

### FX3U-4LC

- Mass (Weight): Approx. 0.4 kg
- External color: Munsell 0.08GY/7.64/0.81
- M3 terminal screw for terminal block
- DIN rail of 35 mm in width can be installed

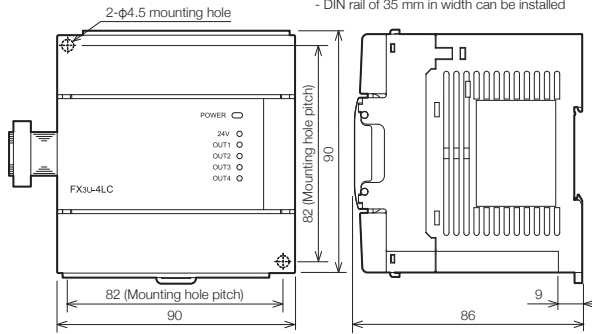

### FX3U-2HC

- Mass (Weight): Approx. 0.2 kg
- External color: Munsell 0.08GY/7.64/0.81
- DIN rail of 35 mm in width can be installed

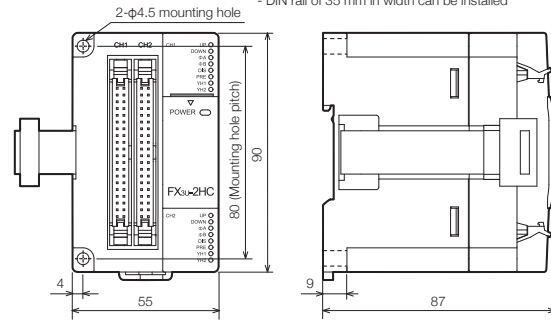

### FX3U-1PG

- Mass (Weight): Approx. 0.2 kg
- External color: Munsell 0.08GY/7.64/0.81
- M3 terminal screw for terminal block
- DIN rail of 35 mm in width can be installed

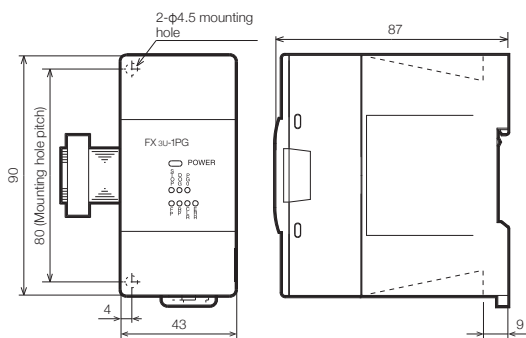

### FX3U-128ASL-M

- Mass (Weight): Approx. 0.2 kg
- External color: Munsell 0.08GY/7.64/0.81
- DIN rail of 35 mm in width can be installed

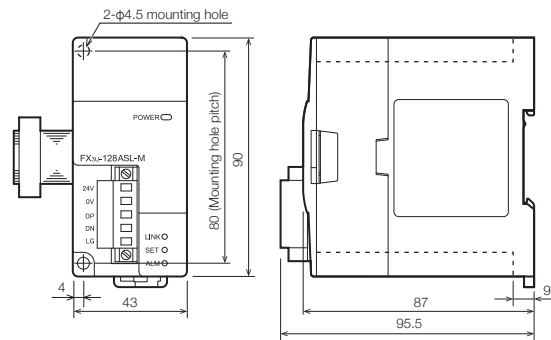

### FX3U-32DP

- Mass (Weight): Approx. 0.2 kg
- External color: Munsell 0.08GY/7.64/0.81

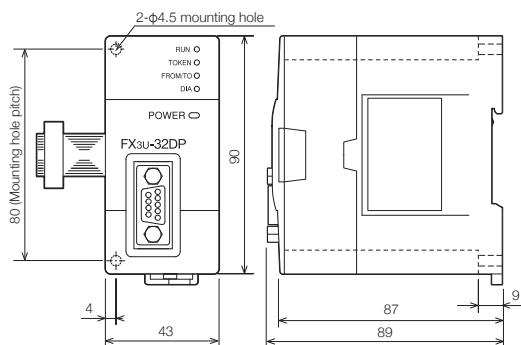

# External Dimensions

Unit: mm

## Terminal block (common to all models)

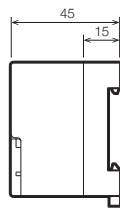
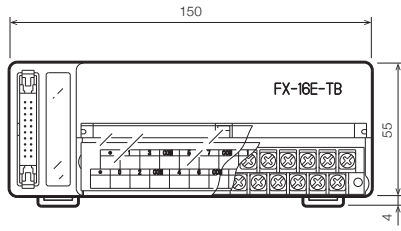

- External color: Munsell 0.08GY/7.64/0.81
- Accessory: Terminal block arrangement card
- M3.5 terminal screw for terminal block
- DIN rail of 35 mm in width can only be installed

# Terminal Arrangement

## FX5S CPU module

### FX5S-30MR/ES, FX5S-30MT/ES

$\perp$	S/S	1	3	5	7	11	13	15	17
L	N	X0	2	4	6	X10	12	14	16
0V	Y0	2	COM1	5	7	Y10	12	Y13	15
24V	COM0	1	3	Y4	6	COM2	11	COM3	14

### FX5S-30MT/ESS

0V	Y0	2	+V1	5	7	Y10	12	Y13	15
24V	+V0	1	3	Y4	6	+V2	11	+V3	14

### FX5S-40MR/ES, FX5S-40MT/ES

$\perp$	S/S	1	3	5	7	11	13	15	17	21	23	25	27
L	N	X0	2	4	6	X10	12	14	16	X20	22	24	26
0V	Y0	2	•	Y4	6	•	Y10	12	•	Y14	16	•	
24V	COM0	1	3	COM1	5	7	COM2	11	13	COM3	15	17	

### FX5S-40MT/ESS

0V	Y0	2	•	Y4	6	•	Y10	12	•	Y14	16	•
24V	+V0	1	3	+V1	5	7	+V2	11	13	+V3	15	17

### FX5S-60MR/ES, FX5S-60MT/ES

$\perp$	S/S	1	3	5	7	11	13	15	17	21	23	25	27	31	33	35	37	41	43
L	N	X0	2	4	6	X10	12	14	16	X20	22	24	26	X30	32	34	36	X40	42
0V	Y0	2	•	Y4	6	•	Y10	12	•	Y14	16	•	Y20	22	•	Y24	26	•	
24V	COM0	1	3	COM1	5	7	COM2	11	13	COM3	15	17	COM4	21	23	COM5	25	27	

### FX5S-60MT/ESS

0V	Y0	2	•	Y4	6	•	Y10	12	•	Y14	16	•	Y20	22	•	Y24	26	•
24V	+V0	1	3	+V1	5	7	+V2	11	13	+V3	15	17	+V4	21	23	+V5	25	27

# Terminal Arrangement

## FX5UJ CPU module

### FX5UJ-24MR/ES, FX5UJ-24MT/ES

	⏏	S/S	1	3	5	7	11	13	15
L	N	X0	2	4	6	X10	12	14	
0V	Y0	2	Y3	5	Y6	10	•		
24V	COM0	1	COM1	4	COM2	7	11		

### FX5UJ-24MT/ESS

0V	Y0	2	Y3	5	Y6	10	•		
24V	+V0	1	+V1	4	+V2	7	11		

### FX5UJ-40MR/ES, FX5UJ-40MT/ES

	⏏	S/S	1	3	5	7	11	13	15	17	21	23	25	27
L	N	X0	2	4	6	X10	12	14	16	20	22	24	26	
0V	Y0	2	•	Y4	6	•	Y10	12	•	Y14	16	•		
24V	COM0	1	3	COM1	5	7	COM2	11	13	COM3	15	17		

### FX5UJ-40MT/ESS

0V	Y0	2	•	Y4	6	•	Y10	12	•	Y14	16	•		
24V	+V0	1	3	+V1	5	7	+V2	11	13	+V3	15	17		

### FX5UJ-60MR/ES, FX5UJ-60MT/ES

	⏏	S/S	1	3	5	7	11	13	15	17	21	23	25	27	31	33	35	37	41	43
L	N	X0	2	4	6	X10	12	14	16	X20	22	24	26	X30	32	34	36	X40	42	
0V	Y0	2	•	Y4	6	•	Y10	12	•	Y14	16	•	Y20	22	•	Y24	26	•		
24V	COM0	1	3	COM1	5	7	COM2	11	13	COM3	15	17	COM4	21	23	COM5	25	27		

### FX5UJ-60MT/ESS

0V	Y0	2	•	Y4	6	•	Y10	12	•	Y14	16	•	Y20	22	•	Y24	26	•		
24V	+V0	1	3	+V1	5	7	+V2	11	13	+V3	15	17	+V4	21	23	+V5	25	27		



**FX5U CPU module**

**FX5U-32MR/ES, FX5U-32MT/ES**

$\frac{\perp}{\perp}$	S/S	0V	X0	2	4	6	X10	12	14	16	•
L	N	•	24V	1	3	5	7	11	13	15	17
Y0	2	•	Y4	6	•	Y10	12	•	Y14	16	•
COM0	1	3	COM1	5	7	COM2	11	13	COM3	15	17

**FX5U-32MR/DS, FX5U-32MT/DS**

$\frac{\perp}{\perp}$	S/S	•	X0	2	4	6	X10	12	14	16	•
⊕	⊖	•	•	1	3	5	7	11	13	15	17
Y0	2	•	Y4	6	•	Y10	12	•	Y14	16	•
COM0	1	3	COM1	5	7	COM2	11	13	COM3	15	17

**FX5U-32MT/ESS**

Y0	2	•	Y4	6	•	Y10	12	•	Y14	16	•
+V0	1	3	+V1	5	7	+V2	11	13	+V3	15	17

**FX5U-32MT/DSS**

Y0	2	•	Y4	6	•	Y10	12	•	Y14	16	•
+V0	1	3	+V1	5	7	+V2	11	13	+V3	15	17

**FX5U-64MR/ES, FX5U-64MT/ES**

$\frac{\perp}{\perp}$	S/S	0V	0V	X0	2	4	6	X10	12	14	16	X20	22	24	26	X30	32	34	36	•
L	N	•	24V	24V	1	3	5	7	11	13	15	17	21	23	25	27	31	33	35	37
Y0	2	•	Y4	6	•	Y10	12	•	Y14	16	•	Y20	22	24	26	Y30	32	34	36	COM5
COM0	1	3	COM1	5	7	COM2	11	13	COM3	15	17	COM4	21	23	25	27	31	33	35	37

**FX5U-64MT/ESS**

Y0	2	•	Y4	6	•	Y10	12	•	Y14	16	•	Y20	22	24	26	Y30	32	34	36	+V5
+V0	1	3	+V1	5	7	+V2	11	13	+V3	15	17	+V4	21	23	25	27	31	33	35	37

**FX5U-64MR/DS, FX5U-64MT/DS**

$\frac{\perp}{\perp}$	S/S	•	•	X0	2	4	6	X10	12	14	16	X20	22	24	26	X30	32	34	36	•
⊕	⊖	•	•	•	1	3	5	7	11	13	15	17	21	23	25	27	31	33	35	37
Y0	2	•	Y4	6	•	Y10	12	•	Y14	16	•	Y20	22	24	26	Y30	32	34	36	COM5
COM0	1	3	COM1	5	7	COM2	11	13	COM3	15	17	COM4	21	23	25	27	31	33	35	37

**FX5U-64MT/DSS**

Y0	2	•	Y4	6	•	Y10	12	•	Y14	16	•	Y20	22	24	26	Y30	32	34	36	+V5
+V0	1	3	+V1	5	7	+V2	11	13	+V3	15	17	+V4	21	23	25	27	31	33	35	37

# Terminal Arrangement

## FX5U CPU module

### FX5U-80MR/ES, FX5U-80MT/ES

$\perp$	S/S	0V	0V	X0	2	4	6	X10	12	14	16			X20	22	24	26		X30	32	34	36		X40	42	44	46				
L	N	•	24V	24V	1	3	5	7	11	13	15			17	•	21	23	25	27	•	31	33	35	37	•	41	43	45	47		
Y0	2	•	Y4	6	•	Y10	12	•	Y14	16	•	Y20	22	24	26					Y30	32	34	36	•	Y40	42	44	46	•		
COM0	1	3	COM1	5	7	COM2	11	13	COM3	15	17	COM4	21	23	25					27	•	COM5	31	33	35	37	COM6	41	43	45	47

### FX5U-80MT/ESS

Y0	2	•	Y4	6	•	Y10	12	•	Y14	16	•	Y20	22	24	26					Y30	32	34	36	•	Y40	42	44	46	•		
+V0	1	3	+V1	5	7	+V2	11	13	+V3	15	17	+V4	21	23	25					27	•	+V5	31	33	35	37	+V6	41	43	45	47

### FX5U-80MR/DS, FX5U-80MT/DS

$\perp$	S/S	•	•	X0	2	4	6	X10	12	14	16			X20	22	24	26		X30	32	34	36		X40	42	44	46	•			
⊕	⊖	•	•	•	1	3	5	7	11	13	15			17	•	21	23	25	27	•	31	33	35	37	•	41	43	45	47		
Y0	2	•	Y4	6	•	Y10	12	•	Y14	16	•	Y20	22	24	26					Y30	32	34	36	•	Y40	42	44	46	•		
COM0	1	3	COM1	5	7	COM2	11	13	COM3	15	17	COM4	21	23	25					27	•	COM5	31	33	35	37	COM6	41	43	45	47

### FX5U-80MT/DSS

Y0	2	•	Y4	6	•	Y10	12	•	Y14	16	•	Y20	22	24	26					Y30	32	34	36	•	Y40	42	44	46	•		
+V0	1	3	+V1	5	7	+V2	11	13	+V3	15	17	+V4	21	23	25					27	•	+V5	31	33	35	37	+V6	41	43	45	47

## FX5UC CPU module

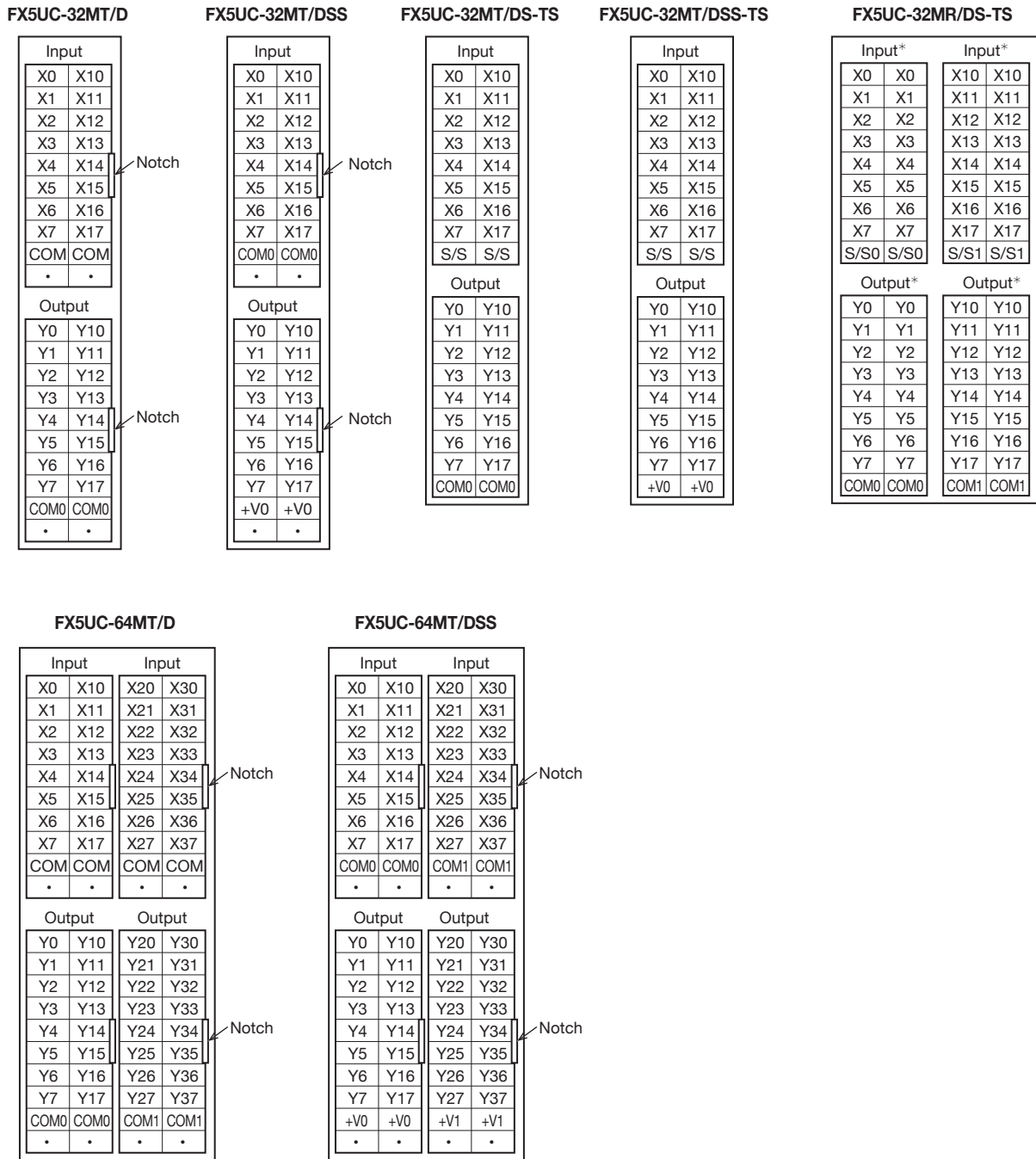

\*: Terminals with the same name (such as X0 and X0) are connected inside the PLC.

# Terminal Arrangement

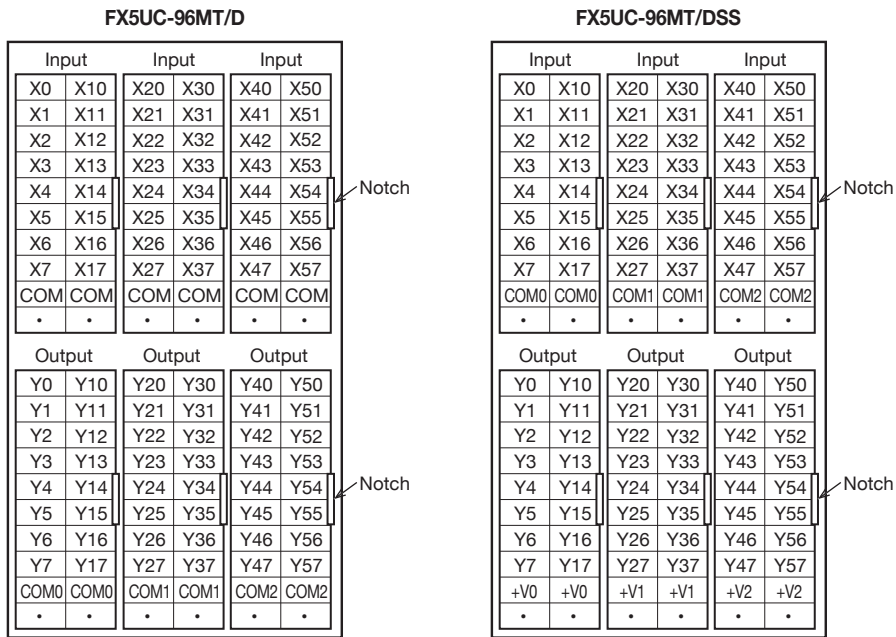

## Safety extension module

**FX5-SF-MU4T5**

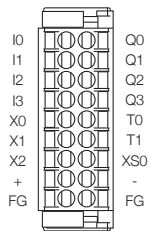

Left side of terminal arrangement		Right side of terminal arrangement	
Name	Description	Name	Description
I0	Safety input 0	Q0	Safety output 0
I1	Safety input 1	Q1	Safety output 1
I2	Safety input 2	Q2	Safety output 2
I3	Safety input 3	Q3	Safety output 3
X0	General input 0	T0	Test output 0
X1	General input 1	T1	Test output 1
X2	General input 2	XS0	ENABLE input
+	External 24 V +24 V terminal	-	External 24 V Ground terminal
FG	Frame ground	FG	Frame ground

**FX5-SF-8DI4**

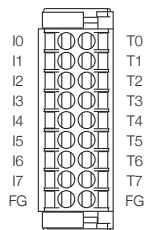

Left side of terminal arrangement		Right side of terminal arrangement	
Name	Description	Name	Description
I0	Safety input 0	T0	Test output 0
I1	Safety input 1	T1	Test output 1
I2	Safety input 2	T2	Test output 2
I3	Safety input 3	T3	Test output 3
I4	Safety input 4	T4	Test output 4
I5	Safety input 5	T5	Test output 5
I6	Safety input 6	T6	Test output 6
I7	Safety input 7	T7	Test output 7
FG	Frame ground	FG	Frame ground

I/O module

◇ Input module/output module (extension cable type)

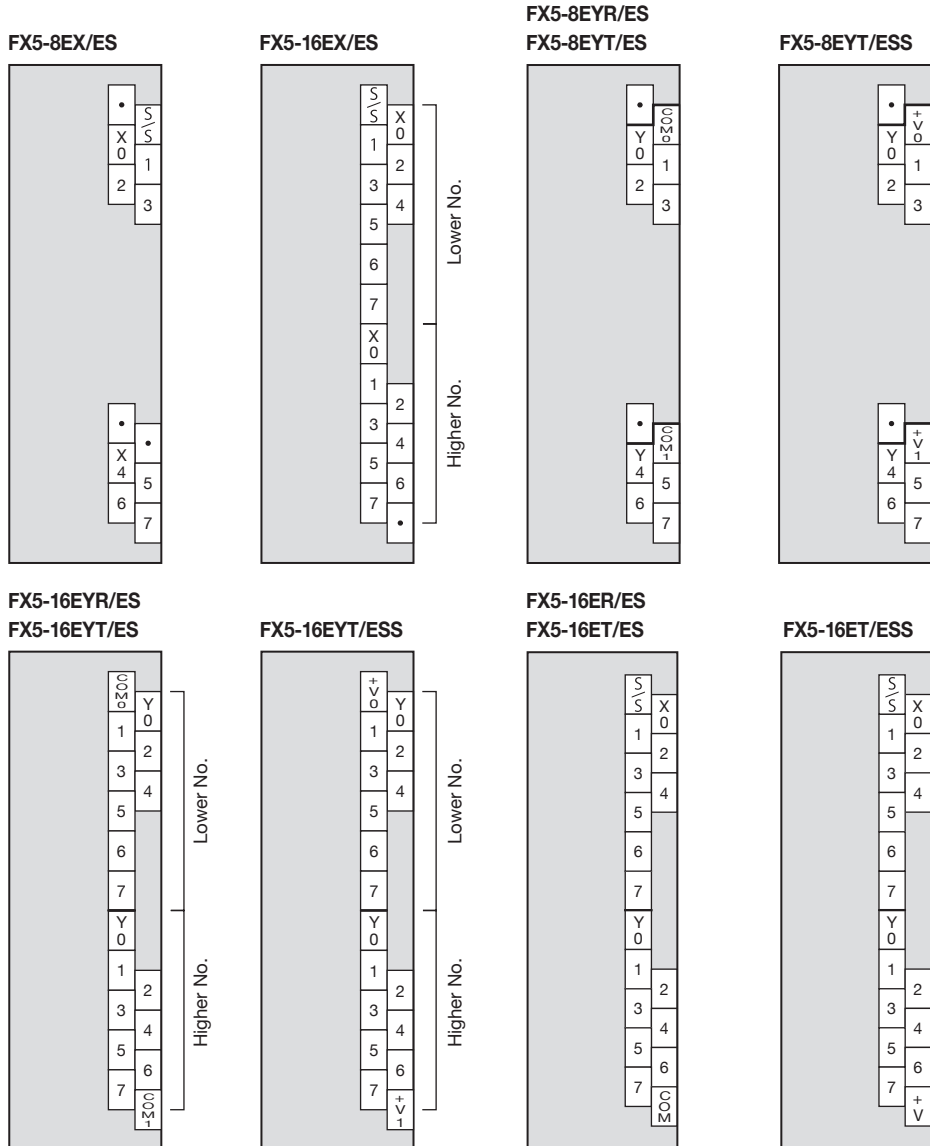

# Terminal Arrangement

## ◇ High-speed pulse input/output module

FX5-16ET/ES-H

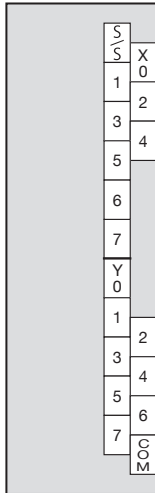

FX5-16ET/ESS-H

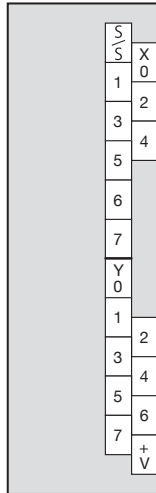

## ◇ Powered input/output modules

FX5-32ER/ES, FX5-32ET/ES

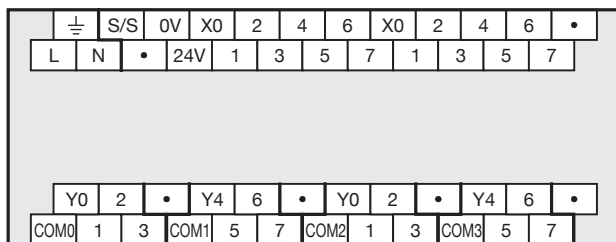

FX5-32ER/DS, FX5-32ET/DS

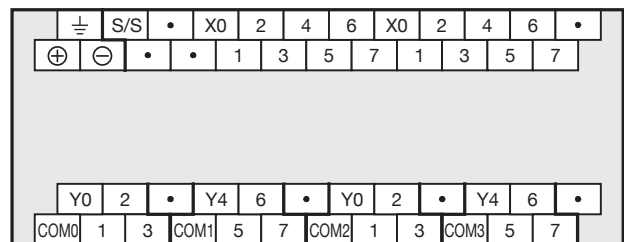

FX5-32ET/ESS

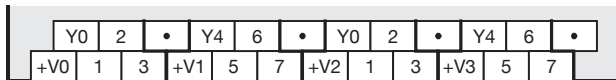

FX5-32ET/DSS

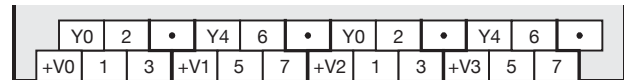

I/O module

◇ Input module/output module (extension connector type)

FX5-C16EX/D

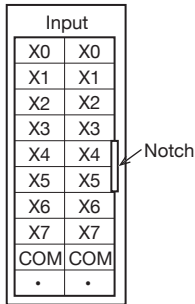

FX5-C16EX/DS

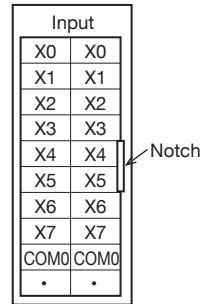

FX5-C32EX/D

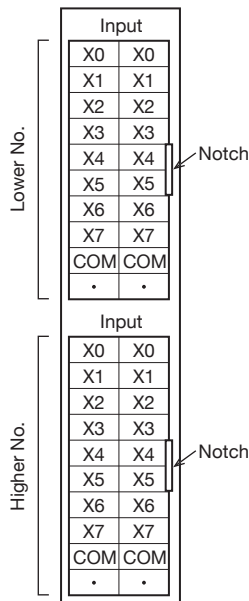

FX5-C32EX/DS

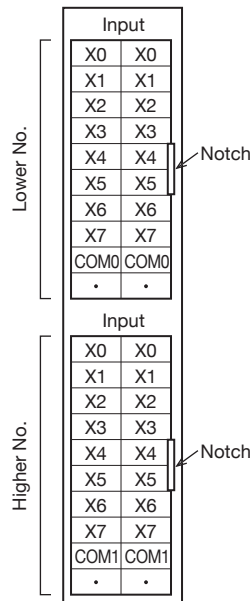

FX5-C32EX/DS-TS

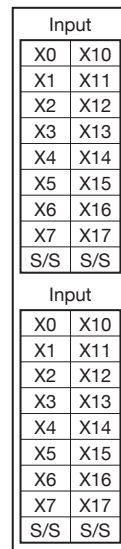

# Terminal Arrangement

**FX5-C16EYT/D**

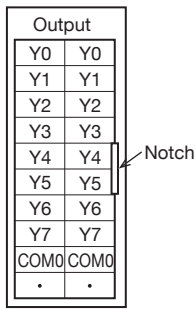

**FX5-C16EYT/DSS**

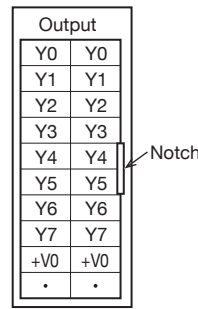

**FX5-C32EYT/D**

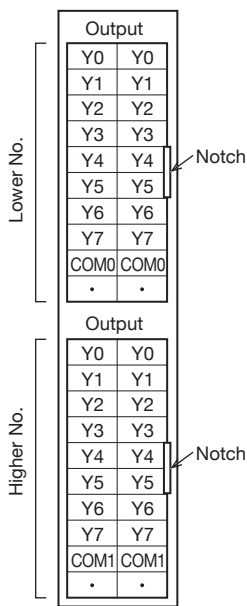

**FX5-C32EYT/D-TS**

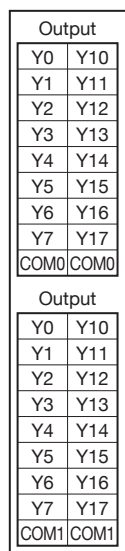

**FX5-C32EYT/DSS**

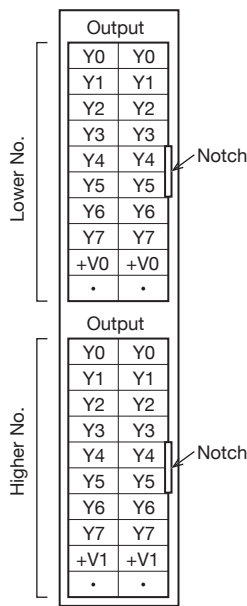

**FX5-C32EYT/DSS-TS**

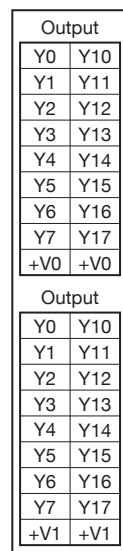

**FX5-C16EYR/D-TS**

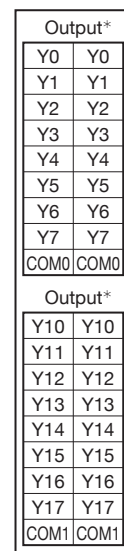

\*: Terminals with the same name (such as Y0 and Y0) are connected inside the PLC.



## ◇ I/O module (extension connector type)

**FX5-C32ET/D**

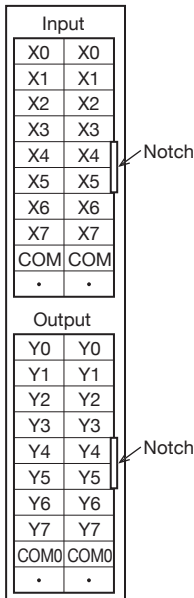

**FX5-C32ET/DS-TS**

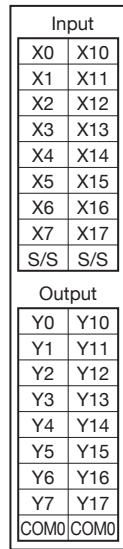

**FX5-C32ET/DSS**

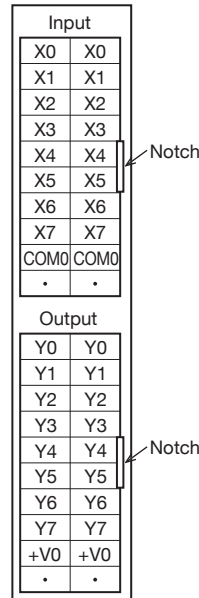

**FX5-C32ET/DSS-TS**

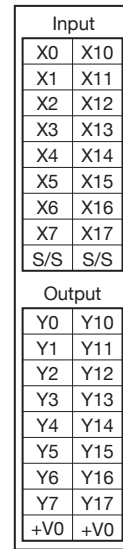

# Terminal Arrangement

## FX5 intelligent function module

FX5-4AD

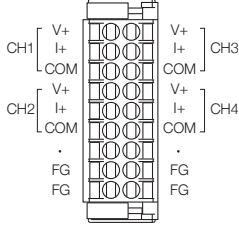

FX5-4DA

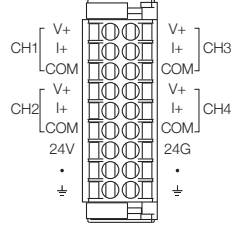

FX5-8AD

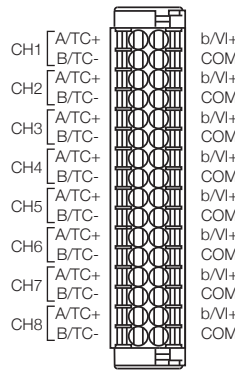

FX5-4LC

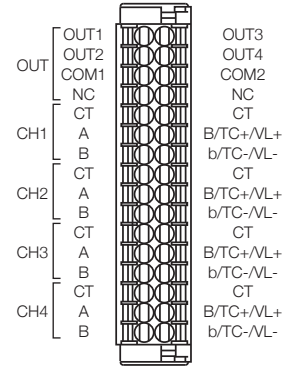

FX5-20PG-P

		Axis 2 (AX2)		Axis 1 (AX1)	
Pin No.	Signal name	Pin No.	Signal name	Pin No.	Signal name
B20		A20	PULSER B-	A20	PULSER B+
B19		A19	PULSER A-	A19	PULSER A+
B18		A18	PULSE COM	A18	PULSE COM
B17		A17	PULSE R	A17	PULSE R
B16		A16	PULSE COM	A16	PULSE COM
B15		A15	PULSE F	A15	PULSE F
B14		A14	CLRCOM	A14	CLRCOM
B13		A13	CLEAR	A13	CLEAR
B12		A12	RDYCOM	A12	RDYCOM
B11		A11	READY	A11	READY
B10		A10	PG0COM	A10	PG0COM
B9		A9	PG05	A9	PG05
B8		A8	PG024	A8	PG024
B7		A7	COM	A7	COM
B6		A6	COM	A6	COM
B5		A5	CHG	A5	CHG
B4		A4	STOP	A4	STOP
B3		A3	DOG	A3	DOG
B2		A2	RLS	A2	RLS
B1		A1	FLS	A1	FLS

FX5-20PG-D

		Axis 2 (AX2)		Axis 1 (AX1)	
Pin No.	Signal name	Pin No.	Signal name	Pin No.	Signal name
B20		A20	PULSER B-	A20	PULSER B+
B19		A19	PULSER A-	A19	PULSER A+
B18		A18	PULSE R-	A18	PULSE R-
B17		A17	PULSE R+	A17	PULSE R+
B16		A16	PULSE F-	A16	PULSE F-
B15		A15	PULSE F+	A15	PULSE F+
B14		A14	CLRCOM	A14	CLRCOM
B13		A13	CLEAR	A13	CLEAR
B12		A12	RDYCOM	A12	RDYCOM
B11		A11	READY	A11	READY
B10		A10	PG0COM	A10	PG0COM
B9		A9	PG05	A9	PG05
B8		A8	PG024	A8	PG024
B7		A7	COM	A7	COM
B6		A6	COM	A6	COM
B5		A5	CHG	A5	CHG
B4		A4	STOP	A4	STOP
B3		A3	DOG	A3	DOG
B2		A2	RLS	A2	RLS
B1		A1	FLS	A1	FLS

FX5-40SSC-S, FX5-80SSC-S

Pin No.	Signal name	Pin No.	Signal name
1	No connect	14	No connect
2	SG	15	SG
3	HA	16	HB
4	HAH	17	HBH
5	HAL	18	HBL
6 to 9	No connect	19 to 22	No connect
10	EMI	23	EMI.COM
11	DI1	24	DI2
12	DI3	25	DI4
13	COM	26	COM

FX5-ENET, FX5-ENET/IP, FX5-OPC

Pin No.	Signal name	Description
1	TP0+	Data 0 transmission/reception (positive side)
2	TP0-	Data 0 transmission/reception (negative side)
3	TP1+	Data 1 transmission/reception (positive side)
4	TP2+	Data 2 transmission/reception (positive side)
5	TP2-	Data 2 transmission/reception (negative side)
6	TP1-	Data 1 transmission/reception (negative side)
7	TP3+	Data 3 transmission/reception (positive side)
8	TP3-	Data 3 transmission/reception (negative side)

## FX5-CCL-MS

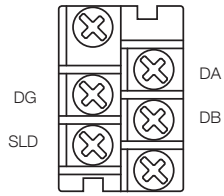

## FX5-CCLIEF, FX5-CCLGN-MS FX5-40SSC-G, FX5-80SSC-G

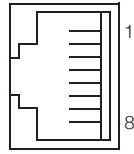

Pin No.	Signal name	Description
1	TP0+	Data 0 transmission/reception (positive side)
2	TP0-	Data 0 transmission/reception (negative side)
3	TP1+	Data 1 transmission/reception (positive side)
4	TP2+	Data 2 transmission/reception (positive side)
5	TP2-	Data 2 transmission/reception (negative side)
6	TP1-	Data 1 transmission/reception (negative side)
7	TP3+	Data 3 transmission/reception (positive side)
8	TP3-	Data 3 transmission/reception (negative side)

## FX5-ASL-M

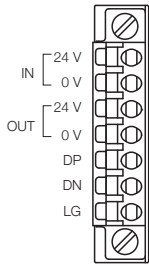

## FX5-DP-M

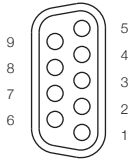

Pin No.	Signal name	Description
1	NC	Not connected
2	NC	Not connected
3	RxD/TxD-P	Receive/send data-P
4	CNTR-P*1	Control signal of repeaters
5	DGND*2	Data ground
6	VP*2	Voltage+
7	NC	Not connected
8	RxD/TxD-N	Receive/send data-N
9	NC	Not connected

\*1: Optional signal

\*2: Signal used for connecting a bus terminator

## Expansion adapter

### FX5-4A-ADP

V1+
I1+
COM1
V2+
I2+
COM2
•
V3+
I3+
COM3
V4+
I4+
COM4

### FX5-4AD-ADP

V1+
I1+
COM1
V2+
I2+
COM2
V3+
I3+
COM3
V4+
I4+
COM4
⏏

### FX5-4DA-ADP

V1+
I1+
COM1
V2+
I2+
COM2
V3+
I3+
COM3
V4+
I4+
COM4
•

### FX5-4AD-PT-ADP

L1+
L1-
I1-
L2+
L2-
I2-
L3+
L3-
I3-
L4+
L4-
•

### FX5-4AD-TC-ADP

•
L1+
L1-
•
L2+
L2-
•
L3+
L3-
•
L4+
L4-
•

### FX5-232ADP

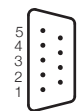

Pin No.	Signal
1	CD (CCD)
2	RD (RXD)
3	SD (TXD)
4	ER (DTR)
5	SG (GND)
6	DR (DSR)
7, 8, 9	Not used

9-pin D-SUB (male)  
Mounting screw:  
1/4 inch thread

### FX5-485ADP

5 poles

Ⓜ	RDA (RXD+)
Ⓜ	RDB (RXD-)
Ⓜ	SDA (TXD+)
Ⓜ	SDB (TXD-)
Ⓜ	SG (GND)

# Terminal Arrangement

## Expansion board

### FX5-232-BD

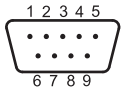

Pin No.	Signal
1	CD (DCD)
2	RD (RXD)
3	SD (TXD)
4	ER (DTR)
5	SG (GND)
6	DR (DSR)
7, 8, 9	Not used

9-pin D-SUB (male)  
Mounting screw:  
Inch thread

### FX5-485-BD

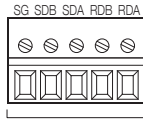

5 poles

Signal Name
RDA (RXD+)
RDB (RXD-)
SDA (TXD+)
SDB (TXD-)
SG (GND)

### FX5-422-BD-GOT



8-pin MINI-DIN (female)

## FX5 extension power supply module

### FX5-1PSU-5V



### FX5-C1PS-5V



### FX3U-1PSU-5V



## FX3 intelligent function module

### FX3U-4AD



### FX3U-4DA



### FX3U-4LC

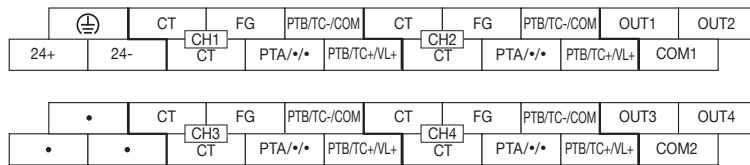

### FX3U-2HC

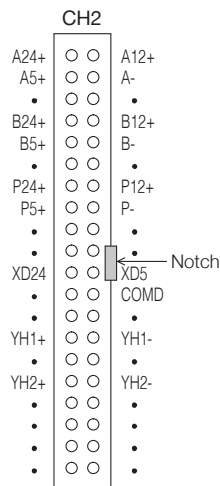
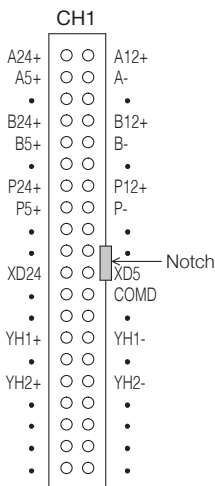

### FX3U-1PG

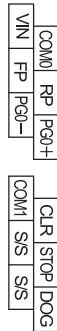

### FX3U-64CCL



### FX3U-16CCL-M



### FX3U-128ASL-M

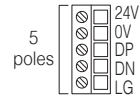

### FX3U-32DP

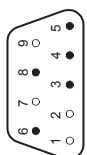

● Assigned  
○ Not assigned

Pin No.	Signal name	Description
3	FXD/TXD-P	Receive/send data-P
4	RTS	Ready to send
5	DGND	Data ground
6	VP	Voltage+
8	FXD/TXD-N	Receive/send data-N
1, 2, 7, 9	NC	Not assigned

## ◇ Type system (CPU module, input/output extension device)

(1)	CPU category	FX5S, FX5UJ, FX5U, FX5UC, etc.		Model system			
(2)	Type category	C (Extension connector type) None (Extension cable type)		<div style="font-size: 2em; font-weight: bold; margin: 0;"> <b>FX5 - C 32 M R /ES - □</b> </div> <div style="display: flex; justify-content: space-around; margin-top: 10px;"> <span>(1)</span> <span>(2)</span> <span>(3)</span> <span>(4)</span> <span>(5)</span> <span>(6)</span> <span>(7)</span> </div>			
(3)	Total number of input/output points	8, 16, 24, 30, 32, 40, 60, 64, 80, 96, etc.					
(4)	Module category	M	CPU module				
		E	Extension devices including both input and output devices				
		EX	Input extension module				
(5)	Output type	R	Relay output				
		T	Transistor output				
(6)	Power supply, input/output system		CPU module, extension module		Input/output extension module		
		Symbol	Power supply	Input type	Transistor output type	Input type	Transistor output type
		/ES	AC	24 V DC, sink/source	sink	sink/source	—
		/ESS	AC	24 V DC, sink/source	source	—	source
		/DS	DC	24 V DC, sink/source	sink	sink/source	—
		/DSS	DC	24 V DC, sink/source	source	—	source
(7)	Other suffix symbols	-H	High-speed input/output function expansion				
		-TS	Spring clamp terminal block				

## ◇ Input signal format

- When a contactless sensor output is connected to PLC, NPN open collector transistor output via sink input wiring, and PNP open collector transistor output can be handled via source input wiring.
- S/S terminal and 24 V terminal are short-circuited by sink input wiring. (Left side of the drawing below) S/S terminal and 0 V terminal are short-circuited by source input wiring. (Right side of the drawing below)

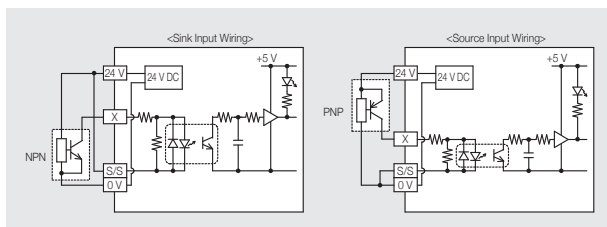

## ◇ Output signal format

- Relay output type is mechanically insulated by a relay, while transistor output type is insulated by a photocoupler. In addition, LED for output indication is driven by internal power supply.
- Transistor output is made up of NPN open collector output (sink [-common]) system and NPN open collector output (source [+common]) system.

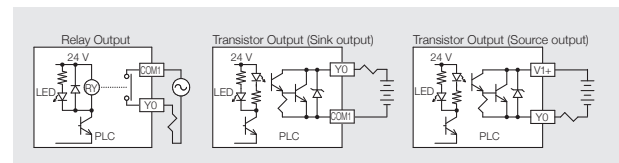

# Terminal Arrangement

memo

# Products List

## ◇ CPU module

Model	Specifications				Description page
	Rated voltage	Input	Output		
◆ FX5S CPU modules					
FX5S-30MR/ES	100 to 240 V AC 50/60 Hz	16 points	24 V DC sink/source	Relay	82
FX5S-30MT/ES				Transistor/sink	82
FX5S-30MT/ESS				Transistor/source	82
FX5S-40MR/ES		24 points		Relay	82
FX5S-40MT/ES				Transistor/sink	82
FX5S-40MT/ESS				Transistor/source	82
FX5S-60MR/ES		36 points		Relay	82
FX5S-60MT/ES				Transistor/sink	82
FX5S-60MT/ESS	Transistor/source		82		
◆ FX5UJ CPU modules					
FX5UJ-24MR/ES	100 to 240 V AC 50/60 Hz	14 points	24 V DC sink/source	Relay	84
FX5UJ-24MT/ES				Transistor/sink	84
FX5UJ-24MT/ESS				Transistor/source	84
FX5UJ-40MR/ES		24 points		Relay	84
FX5UJ-40MT/ES				Transistor/sink	84
FX5UJ-40MT/ESS				Transistor/source	84
FX5UJ-60MR/ES		36 points		Relay	84
FX5UJ-60MT/ES				Transistor/sink	84
FX5UJ-60MT/ESS	Transistor/source		84		
◆ FX5U CPU modules					
FX5U-32MR/ES	100 to 240 V AC 50/60 Hz	16 points	24 V DC sink/source	Relay	90
FX5U-32MT/ES				Transistor/sink	90
FX5U-32MT/ESS				Transistor/source	90
FX5U-64MR/ES		32 points		Relay	90
FX5U-64MT/ES				Transistor/sink	90
FX5U-64MT/ESS				Transistor/source	90
FX5U-80MR/ES		40 points		Relay	90
FX5U-80MT/ES				Transistor/sink	90
FX5U-80MT/ESS	Transistor/source		90		
FX5U-32MR/DS	24 V DC	16 points	24 V DC sink/source	Relay	91
FX5U-32MT/DS				Transistor/sink	91
FX5U-32MT/DSS				Transistor/source	91
FX5U-64MR/DS		32 points		Relay	91
FX5U-64MT/DS				Transistor/sink	91
FX5U-64MT/DSS				Transistor/source	91
FX5U-80MR/DS		40 points		Relay	91
FX5U-80MT/DS				Transistor/sink	91
FX5U-80MT/DSS	Transistor/source		91		
◆ FX5UC CPU modules					
FX5UC-32MT/D	24 V DC	16 points	24 V DC sink	Transistor/sink	99
FX5UC-32MT/DSS			Transistor/source	99	
FX5UC-32MT/DS-TS			24 V DC sink/source	Transistor/sink	99
FX5UC-32MT/DSS-TS			Transistor/source	99	
FX5UC-32MR/DS-TS		16 points	24 V DC sink/source	Relay	99
FX5UC-64MT/D		32 points	24 V DC sink	Transistor/sink	99
FX5UC-64MT/DSS			24 V DC sink/source	Transistor/source	99
FX5UC-96MT/D		48 points	24 V DC sink	Transistor/sink	99
FX5UC-96MT/DSS			24 V DC sink/source	Transistor/source	99

## ◇ Safety extension module

Model	Specifications	Description page
FX5-SF-MU4T5	Safety main module 4-points safety input/4-points safety output	106
FX5-SF-8DI4	Safety input expansion module 8-points safety input	107

# Products List

## ◇ I/O module

Model	Specifications				Description page	
	Rated voltage	Input	Output			
■■■ Extension cable type ■■■						
◆ Input module						
FX5-8EX/ES	Supplied from CPU module	8 points	24 V DC sink/source	—	110	
FX5-16EX/ES		16 points		—	110	
◆ Output module						
FX5-8EYR/ES	Supplied from CPU module	—	—	8 points	Relay	110
FX5-8EYT/ES				Transistor/sink	110	
FX5-8EYT/ESS				Transistor/source	110	
FX5-16EYR/ES		—	—	16 points	Relay	110
FX5-16EYT/ES				Transistor/sink	110	
FX5-16EYT/ESS				Transistor/source	110	
◆ Input/output module						
FX5-16ER/ES	Supplied from CPU module	8 points	24 V DC sink/source	8 points	Relay	110
FX5-16ET/ES				Transistor/sink	110	
FX5-16ET/ESS				Transistor/source	110	
◆ High-speed pulse input/output module						
FX5-16ET/ES-H	Supplied from CPU module	8 points	24 V DC sink/source	8 points	Transistor/sink	145
FX5-16ET/ESS-H				Transistor/source	145	
◆ Powered input/output module						
FX5-32ER/ES	100 to 240 V AC 50/60 Hz	16 points	24 V DC sink/source	16 points	Relay	109
FX5-32ET/ES				Transistor/sink	109	
FX5-32ET/ESS				Transistor/source	109	
FX5-32ER/DS	24 V DC	16 points	24 V DC sink/source	16 points	Relay	109
FX5-32ET/DS				Transistor/sink	109	
FX5-32ET/DSS				Transistor/source	109	
■■■ Extension connector type ■■■						
◆ Input module						
FX5-C16EX/D	Supplied from CPU module	16 points	24 V DC sink	—	—	111
FX5-C16EX/DS			24 V DC sink/source	—	111	
FX5-C32EX/D		32 points	24 V DC sink	—	—	111
FX5-C32EX/DS			24 V DC sink/source	—	111	
FX5-C32EX/DS-TS			—	—	111	
◆ Output module						
FX5-C16EYT/D	Supplied from CPU module	—	—	16 points	Transistor/sink	111
FX5-C16EYT/DSS				Transistor/source	111	
FX5-C16EYR/D-TS		—	—	16 points	Relay	111
FX5-C32EYT/D		—	—	32 points	Transistor/sink	111
FX5-C32EYT/DSS					Transistor/source	111
FX5-C32EYT/D-TS					Transistor/sink	111
FX5-C32EYT/DSS-TS					Transistor/source	111
◆ Input/output module						
FX5-C32ET/D	Supplied from CPU module	16 points	24 V DC sink	16 points	Transistor/sink	111
FX5-C32ET/DSS			24 V DC sink/source		Transistor/source	111
FX5-C32ET/DS-TS			Transistor/sink		111	
FX5-C32ET/DSS-TS			Transistor/source		111	

## ◇ Expansion boards, Expansion adapter

Model	Specifications	Description page
FX5-232-BD	For RS-232C communication	175
FX5-485-BD	For RS-485 communication	175
FX5-422-BD-GOT	For GOT connection RS-422 communication	175
FX5-SDCD	SD memory card module	189
FX5-232ADP	For RS-232C communication	176
FX5-485ADP	For RS-485 communication	176
FX5-4A-ADP	2 ch analog input/2 ch analog output adapter	121
FX5-4AD-ADP	4 ch analog input adapter	122
FX5-4AD-PT-ADP	4 ch temperature sensor (resistance temperature detector) input adapter	128
FX5-4AD-TC-ADP	4 ch temperature sensor (thermocouple) input adapter	129
FX5-4DA-ADP	4 ch analog output adapter	122

## ◇ FX5 extension power supply module, bus conversion module, connector conversion module

Model	Specifications	Description page
FX5-1PSU-5V	FX5UJ, FX5U (AC power supply type) extension power supply	190
FX5-C1PS-5V	FX5U (DC power supply type)/ FX5UC extension power supply	191
FX5-CNV-BUS	Bus conversion FX5 (extension cable type) → FX3	190
FX5-CNV-BUSC	Bus conversion FX5 (extension connector type) → FX3	190
FX5-CNV-IF	Connector conversion FX5 (extension cable type) → FX5 (extension connector type)	191
FX5-CNV-IFC	Connector conversion FX5 (extension connector type) → FX5 (extension cable type)	191



◇ FX5 intelligent function module

Model	Specifications	Description page
FX5-4AD	4 ch analog input	123
FX5-4DA	4 ch analog output	124
FX5-8AD	8 ch multi input	123
FX5-4LC	4 ch temperature control	131
FX5-20PG-P	2-axis pulse train positioning (transistor output)	146
FX5-20PG-D	2-axis pulse train positioning (differential driver output)	146
FX5-40SSC-S	Simple motion 4-axis control	148
FX5-80SSC-S	Simple motion 8-axis control	148
FX5-40SSC-G	Motion 4-axis control	149
FX5-80SSC-G	Motion 8-axis control	149
FX5-ENET	Ethernet module	165
FX5-ENET/IP	EtherNet/IP module	167
FX5-CCL-MS	CC-Link system master/intelligent device station	160
FX5-CCLIEF	Intelligent device station for CC-Link IE Field Network	159
FX5-CCLGN-MS	CC-Link IE TSN master/local module	158
FX5-ASL-M	AnyWireASLINK system master module	171
FX5-DP-M	PROFIBUS-DP master module	174
FX5-OPC	OPC UA module	184

◇ FX3 extension power supply module

Model	Specifications	Description page
FX3U-1PSU-5V	FX3 extension power supply	191

◇ FX3 intelligent function module

Model	Specifications	Description page
FX3U-4AD	4 ch analog input	124
FX3U-4DA	4 ch analog output	125
FX3U-4LC	4 ch temperature control	132
FX3U-1PG	Positioning pulse output 200 kpps	147
FX3U-2HC	2 ch 200 kHz high-speed counter	137
FX3U-16CCL-M	Master for CC-Link V2	162
FX3U-64CCL	Interface for CC-Link V2	163
FX3U-128ASL-M	Master for AnyWireALSINK system	172
FX3U-32DP	PROFIBUS-DP slave	174

◇ Software package

Type	Model	Specifications	Description page
MELSOFT iQ Works (DVD-ROM)	SW2DND-IQWK-E*1	FA engineering software (English version)*2	185
MELSOFT GX Works3 (DVD-ROM)	SW1DND-GXW3-E	PLC engineering software*2 (English version bundled product: GX Works 2, with GX Developer included)	186
MX Component	SW4DNC-ACT-E	ActiveX® library for communication (MX Component Ver. 4)	186
	SW5DND-ACT-E	ActiveX® library for communication (MX Component Ver. 5)	186
MX Sheet	SW2DNC-SHEET-E	Microsoft® Excel® communication support tool (MX Sheet Ver. 2)	186
	SW3DND-SHEET-E	Microsoft® Excel® communication support tool (MX Sheet Ver. 3)	186
MX Works	SW2DNC-SHEETSET-E	A set of MX Component Ver. 4 and MX Sheet Ver. 2	186
	SW3DND-SHEETSET-E	A set of MX Component Ver. 5 and MX Sheet Ver. 3	186

- \*1: If you have a conventional model (SW1DNC-IQWK-E), you cannot update. Please purchase an upgraded version separately. For details, please contact our sales representative.
- \*2: For the corresponding models of each software, please refer to the manual of each product.

◇ Communication cable

Model	Specifications	Description page
FX-232CAB-1	3 m 9-pin D-sub (female) ⇔ 9-pin D-sub (female) (for DOS/V, etc.)	195
MR-J3USBCBL3M	3 m CPU module (built-in connector for USB communication) ⇔ personal computer	195
GT09-C30USB-5P	3 m CPU module (built-in connector for USB communication) ⇔ personal computer Made by Mitsubishi Electric System & Service Co., Ltd.	195

◇ Input/output cable

Model	Specifications	Description page	
FX-16E-150CAB	1.5 m	For connection between terminal block and FX5 PLC (Flat cable with connectors at both ends)	
FX-16E-300CAB	3.0 m		
FX-16E-500CAB	5.0 m		
FX-16E-500CAB-S	5.0 m	Loose wire with connector on one end	194
FX-16E-150CAB-R	1.5 m	For connection between terminal block and FX5 PLC (Multi-core round cable with connectors at both ends)	
FX-16E-300CAB-R	3.0 m		
FX-16E-500CAB-R	5.0 m		

## ◇ Input/output connector

Model	Specifications	Description page
FX2C-I/O-CON	20-pin connector and 10 sets of crimp connector for flat cable	194
FX2C-I/O-CON-S	20-pin connector and 5 sets of housing for loose wire and crimp contact (for 0.3 mm <sup>2</sup> )	194
FX2C-I/O-CON-SA	20-pin connector and 5 sets of housing for loose wire and crimp contact (for 0.5 mm <sup>2</sup> )	194
A6CON1	40-pin connector, soldered type for external device connection (straight protrusion)	194
A6CON2	40-pin connector, crimped type for external device connection (straight protrusion)	194
A6CON4	40-pin connector, soldered type for external device connection (both straight/inclined protrusion type)	194
FX-I/O-CON2-S	40-pin connector, 2 sets for discrete wire, AWG22 (0.3 mm <sup>2</sup> )	194
FX-I/O-CON2-SA	40-pin connector, 2 sets for discrete wire, AWG20 (0.5 mm <sup>2</sup> )	194

## ◇ Terminal block

Model	Specifications	Description page
FX-16E-TB	16 input or output points	193
FX-32E-TB	32 input or output points	193
FX-16E-TB/UL	16 input or output points	193
FX-32E-TB/UL	32 input or output points	193
FX-16EYR-TB	16 relay output points, 2 A/1 point (8 A/4 points)	193
FX-16EYS-TB	16 triac output points, 0.3 A/1 point (0.8 A/4 points)	193
FX-16EYT-TB	16 transistor output points, 0.5 A/1 point (0.8 A/4 points) (sink output)	193
FX-16EYR-ES-TB/UL	16 relay output points, 2 A/1 point (8 A/4 points)	193
FX-16EYS-ES-TB/UL	16 triac output points, 0.3 A/1 point (0.8 A/4 points)	193
FX-16EYT-ESS-TB/UL	16 transistor output points, 0.5 A/1 point (0.8 A/4 points) (source output)	193

## ◇ Power cable

Model	Specifications	Description page
FX2NC-100MPCB	FX5UC CPU module, for 24 V DC power supply	195
FX2NC-100BPCB	Extension module (extension connector type), for 24 V DC input power supply	195
FX2NC-10BPCB1	Extension module (extension connector type), for 24 V DC input power supply connection wiring	195

## ◇ Extended cable, connector conversion adapter

Model	Specifications	Description page	
FX5-30EC	30 cm	For the extension of FX5 extension module	192
FX5-65EC	65 cm		192
FX5-CNV-BC	For the connection between an extended extension cable and an FX5 input/output module (extension cable type), a high-speed pulse input/output module, or an FX5 intelligent function module		192

## ◇ SD memory card, battery

Model	Specifications	Description page
NZ1MEM-2GBSD	SD memory card (2 GB)	189
NZ1MEM-4GBSD	SDHC memory card (4 GB)	189
NZ1MEM-8GBSD	SDHC memory card (8 GB)	189
NZ1MEM-16GBSD	SDHC memory card (16 GB)	189
FX3U-32BL	Battery	189

memo

# Global FA Center

Mitsubishi Electric Corporation FA Centers support all our customers and users of MELSEC iQ-F Series all over the world.

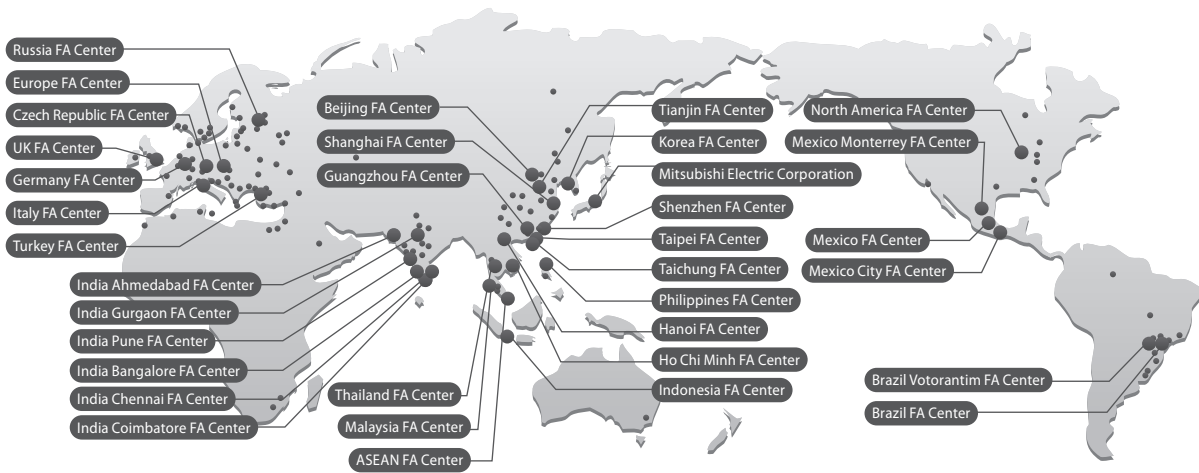

Japan (Tokyo)	FA Global Solution Technical Department	(TEL:+81-3-3218-6422)
Japan (Tokyo)	Asian Business Development Department	(TEL:+81-3-3218-6284)
China (Shanghai)	Mitsubishi Electric Automation (China) Ltd. Shanghai FA Center	(TEL:+86-21-2322-3030)
China (Beijing)	Mitsubishi Electric Automation (China) Ltd. Beijing FA Center	(TEL:+86-10-6518-8830)
China (Tianjin)	Mitsubishi Electric Automation (China) Ltd. Tianjin FA Center	(TEL:+86-22-2813-1015)
China (Shenzhen)	Mitsubishi Electric Automation (China) Ltd. Shenzhen FA Center	(TEL:+86-755-2399-8272)
China (Guangzhou)	Mitsubishi Electric Automation (China) Ltd. Guangzhou FA Center	(TEL:+86-20-8923-6730)
Taiwan (Taichung)	Mitsubishi Electric Taiwan Co., Ltd.	(TEL:+886-4-2359-0688)
Taiwan (Taipei)	SETSUYO ENTERPRISE CO., LTD	(TEL:+886-2-2299-9917)
Korea	Mitsubishi Electric Automation Korea Co., Ltd.	(TEL:+82-2-3660-9632)
ASEAN	Mitsubishi Electric Asia Pte. Ltd.	(TEL:+65-6470-2480)
Malaysia	Malaysia FA Center	(TEL:+60-3-7626-5080)
Indonesia	PT. Mitsubishi Electric Indonesia Cikarang Office	(TEL:+62-21-2961-7797)
Vietnam (Hanoi)	Mitsubishi Electric Vietnam Company Limited Hanoi Branch Office	(TEL:+84-24-3937-8075)
Vietnam (Ho Chi Minh)	Mitsubishi Electric Vietnam Company Limited	(TEL:+84-28-3910-5945)
Thailand	Mitsubishi Electric Factory Automation (Thailand) Co., Ltd.	(TEL:+66-2682-6522 to 31)
Philippines	MELCO Factory Automation Philippines Inc.	(TEL:+63-(0)2-8256-8042)
India (Pune)	Mitsubishi Electric India Pvt. Ltd. Pune Branch	(TEL:+91-20-2710-2000)

India (Gurgaon)	Mitsubishi Electric India Pvt. Ltd. Gurgaon Head Office	(TEL:+91-124-463-0300)
India (Bangalore)	Mitsubishi Electric India Pvt. Ltd. Bangalore Branch	(TEL:+91-80-4020-1600)
India (Chennai)	Mitsubishi Electric India Pvt. Ltd. Chennai Branch	(TEL:+91-4445548772)
India (Ahmedabad)	Mitsubishi Electric India Pvt. Ltd. Ahmedabad Branch	(TEL:+91-7965120063)
India (Coimbatore)	Mitsubishi Electric India Pvt. Ltd. Coimbatore Branch	(TEL:+91-422-4385606)
North America	Mitsubishi Electric Automation, Inc.	(TEL:+1-847-478-2469)
Mexico	Mitsubishi Electric Automation, Inc. Queretaro Office	(TEL:+52-442-153-6014)
Mexico (Mexico City)	Mitsubishi Electric Automation, Inc. Mexico Branch	(TEL:+52-55-3067-7500)
Mexico (Monterrey)	Mitsubishi Electric Automation, Inc. Monterrey Office	(TEL:+52-55-3067-7599)
Brazil	Mitsubishi Electric do Brasil Comercio e Servicos Ltda.	(TEL:+55-11-4689-3000)
Brazil (Votorantim)	MELCO CNC do Brasil Comercio e Servicos S.A.	(TEL:+55-15-3023-9000)
Europe	Mitsubishi Electric Europe B.V. Polish Branch	(TEL:+48-12-347-65-00)
Germany	Mitsubishi Electric Europe B.V. German Branch	(TEL:+49-2102-486-0)
UK	Mitsubishi Electric Europe B.V. UK Branch	(TEL:+44-1707-27-8780)
Czech Republic	Mitsubishi Electric Europe B.V. Czech Branch	(TEL:+420-734-402-587)
Italy	Mitsubishi Electric Europe B.V. Italian Branch	(TEL:+39-039-60531)
Russia	Mitsubishi Electric (Russia) LLC St. Petersburg Branch	(TEL:+7-812-633-3497)
Turkey	Mitsubishi Electric Turkey Elektrik Urunleri A.S.	(TEL:+90-216-969-2500)

## About this product catalog

Due to the constantly growing product range and new or changed product features, the information in this catalog may be updated without notice. Please contact your Mitsubishi Electric product provider for more details.

Texts, figures and diagrams shown in this product catalog are intended exclusively for explanation and assistance in planning and ordering the FX5 programmable logic controllers (PLCs) and the associated accessories. Only the manuals supplied with the modules are relevant for installation, commissioning and handling of the modules and the accessories. The information given in the manuals must be read before installation and commissioning of the modules or software.

If any questions arise regarding the application or use of the PLC modules and accessories described in this catalog, please contact your Mitsubishi Electric product provider.

This catalog confers no industrial property rights or any rights of any other kind, nor does it confer any patent licenses. Mitsubishi Electric Corporation cannot be held responsible for any problems involving industrial property rights which may occur as a result of using the contents noted in this catalog.

©2017 MITSUBISHI ELECTRIC CORPORATION

## TRADEMARKS

- Anywire and AnyWireASLINK are either registered trademarks or trademarks of Anywire Corporation.
- Celeron, Intel, and Pentium are either registered trademarks or trademarks of Intel Corporation in the United States and/or other countries.
- Microsoft, Microsoft Access, ActiveX, Excel, SQL Server, Visual Basic, Visual C++, Visual C# Visual Studio, Windows, Windows NT, Windows Server, Windows Vista, and Windows XP are trademarks of the Microsoft group of companies.
- OPC UA and OPC CERTIFIED logos are registered trademarks of OPC Foundation.  
This product includes software developed by the OpenSSL Project for use in the OpenSSL Toolkit (<http://www.openssl.org/>)  
This product includes software derived from the RSA Data Security, Inc. MD5 Message-Digest Algorithm
- PLCopen and related logos are registered trademarks of PLCopen®.
- QR Code is either a registered trademark or a trademark of DENSO WAVE INCORPORATED in the United States, Japan, and/or other countries.
- The SD and SDHC logos are trademarks of SD-3C, LLC.
- Unicode is either a registered trademark or a trademark of Unicode, Inc. in the United States and other countries.
- "YouTube" and YouTube logo mark are either registered trademarks or trademarks of Google LLC.
- The company names, system names and product names mentioned in this document are either registered trademarks or trademarks of their respective companies.
- In some cases, trademark symbols such as <sup>™</sup> or <sup>®</sup> are not specified in this document.

## Creating Solutions Together.



Low-voltage Power Distribution Products



Transformers, Med-voltage Distribution Products



Power Monitoring and Energy Saving Products



Power (UPS) and Environmental Products



Compact and Modular Controllers



Servos, Motors and Inverters



Visualization: HMIs



Edge Computing Products



Numerical Control (NC)



Collaborative and Industrial Robots



Processing machines: EDM, Lasers



SCADA, analytics and simulation software

Mitsubishi Electric's product lineup, from various controllers and drives to energy-saving devices and processing machines, all help you to automate your world. They are underpinned by software, innovative data monitoring, and modelling systems supported by advanced industrial networking and Edgecross IT/OT connectivity. Together with a worldwide partner ecosystem, Mitsubishi Electric factory automation (FA) has everything to make IoT and Digital Manufacturing a reality.

With a complete portfolio and comprehensive capabilities that combine synergies with diverse business units, Mitsubishi Electric provides a one-stop approach to how companies can tackle the shift to clean energy and energy conservation, carbon neutrality and sustainability, which are now a universal requirement of factories, buildings, and social infrastructure.

We at Mitsubishi Electric FA are your solution partners waiting to work with you as you take a step toward the realization of sustainable manufacturing and society through the application of automation. Let's automate the world together!



# PROGRAMMABLE CONTROLLERS

## MELSEC iQ-F Series

---

### **MITSUBISHI ELECTRIC CORPORATION**

HEAD OFFICE: TOKYO BLDG., 2-7-3, MARUNOUCHI, CHIYODA-KU, TOKYO 100-8310, JAPAN

[www.MitsubishiElectric.com](http://www.MitsubishiElectric.com)