

Function setting method

GF7A Function switch configuration

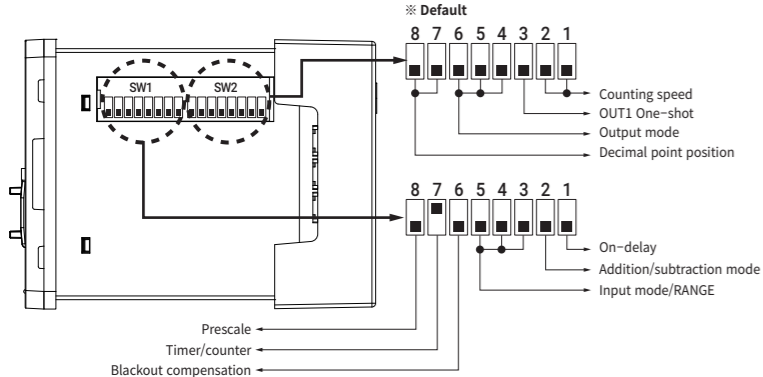

GF7A-SW1 Function chart

Function	On-delay		Addition / Subtraction mode		Blackout compensation		Timer / Counter		Prescale	
	On-delay	Off-delay	Addition mode	Subtraction mode	Blackout compensation	Power reset	Timer	Counter	General coefficient	Prescale
TIME RANGE P62/P61/T6	9999.9s	999999s	99m59.99s	99m59.99s	99999.9m	99h59m59s	9999.9m	99h59m59s	9999.9m	9999.9h
TIME RANGE P42/P41	99.99s	999.9s	9999s	99m59s	999.9m	99h59m	999.9h	9999h		
COUNTER (Input)	U-A	U-B	UD-A	UD-B	UD-C					

GF7A-SW2 Function chart

CPS	30	1	1k	5k	Function	OUT1 HOLD	OUT1 One-shot
TIMER (Output)	F	N	C	R	K	P	Q
COUNTER (Output)	F	N	C	R	K	P	Q
Decimal point position	4 digit	6 digit	4 digit	6 digit	4 digit	6 digit	4 digit

※ Note) When selecting the decimal point position, the selected decimal point position is equally applied to the SV setting value.
 ※ Note) When OUT1 output is selected as One-shot, OUT1 output time is fixed for 0.5 seconds.

GF7A How to set

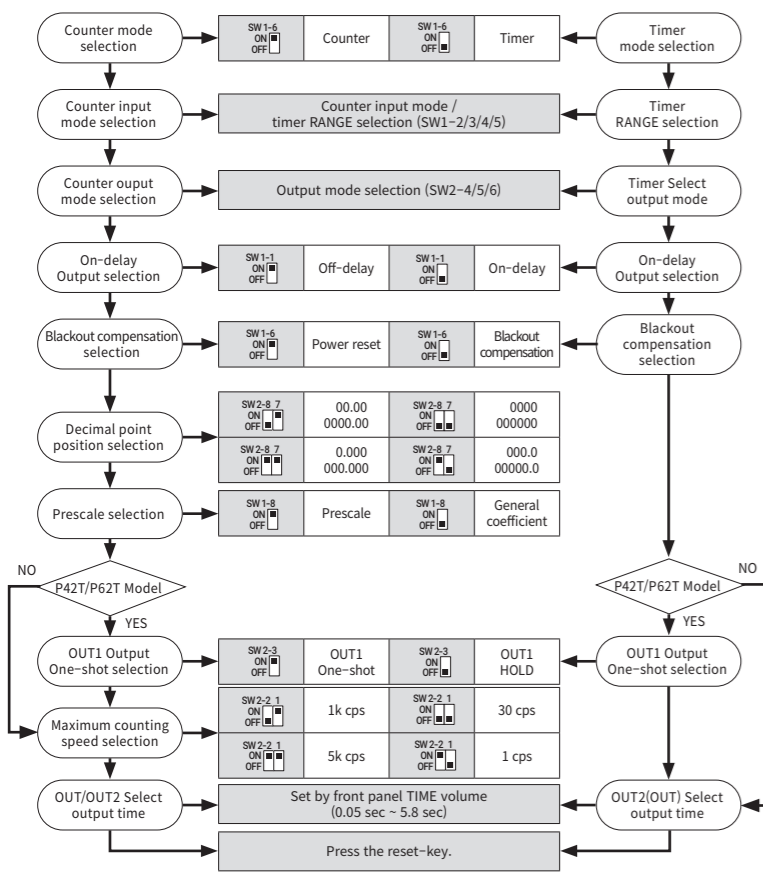

Counter input mode

Addition input

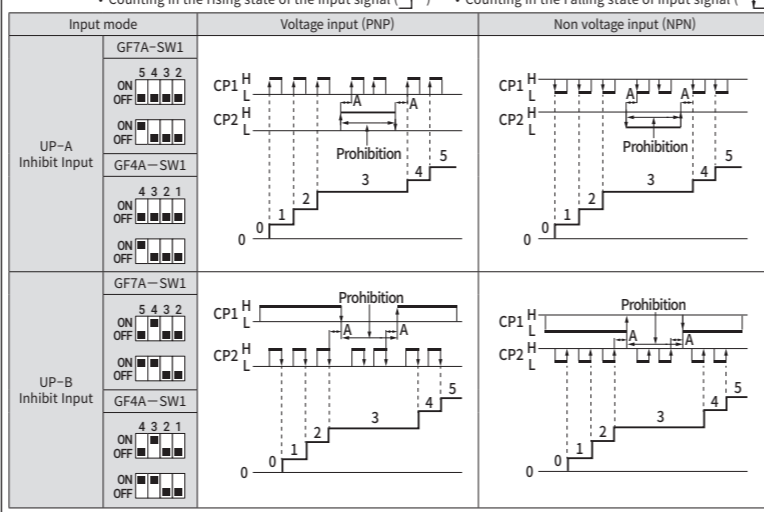

GF4A Function switch configuration

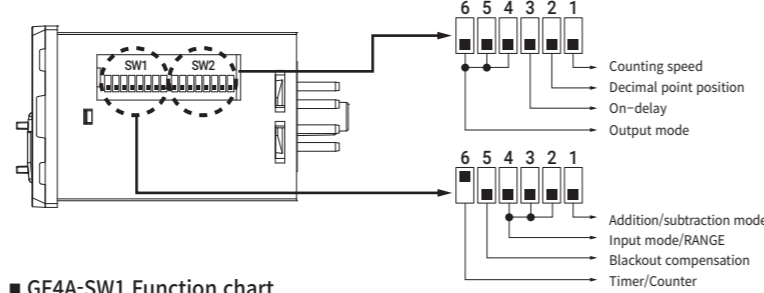

GF4A-SW1 Function chart

Function	Addition / Subtraction mode		Blackout compensation		Timer / Counter	
	Addition mode	Subtraction mode	Blackout compensation	Power reset	Timer	Counter
TIME RANGE	99.99s	999.9s	9999s	99m59s	999.9m	99h59m
COUNTER (Input)	U-A	U-B	UD-A	UD-B	UD-C	

GF4A-SW2 Function chart

CPS	30	5k	Decimal point position	0000	000.0	Function	On-delay	Off-delay
TIMER (Output)	F	N	C	R	K	P	Q	A
COUNTER (Output)	F	N	C	R	K	P	Q	S

※ Note) When selecting the decimal point position, the selected decimal point position is applied equally to the SV setting value.

GF4A How to set

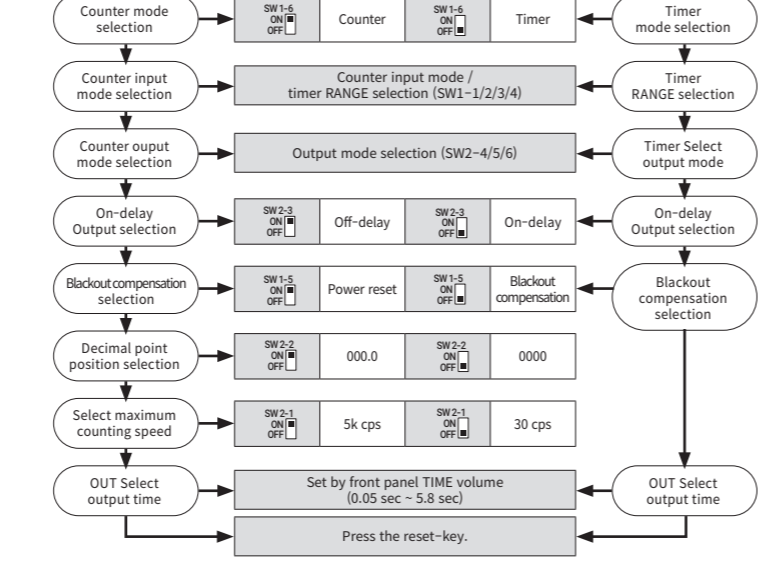

Addition input

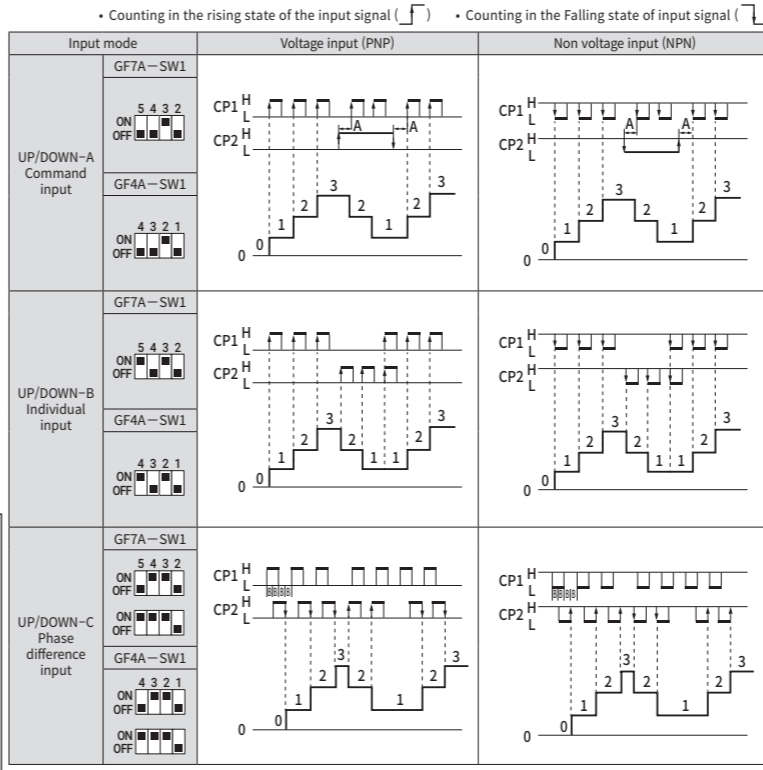

※ Note) 'A' needs more than the minimum signal width, and 'B' needs more than 1/2 of the minimum signal width.

Subtraction input

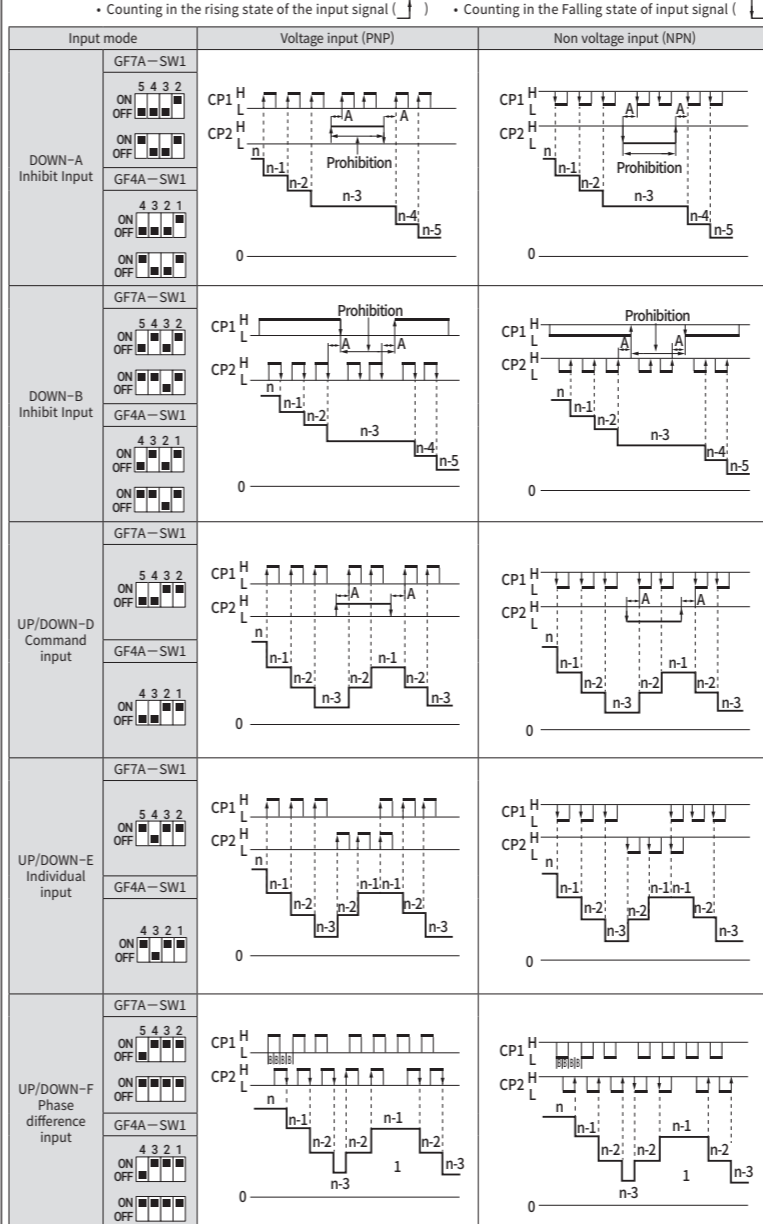

※ Note) 'A' needs more than the minimum signal width, and 'B' needs more than 1/2 of the minimum signal width.

Output mode

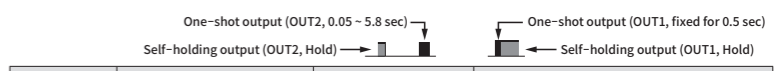

Output mode	Addition mode	Subtraction mode	Operation description
F	RESET MAX SV2 SV1 0 OUT1 OUT2		• Even if the counting value reaches the SV2 setting value, the counting value is displayed continuously increasing or decreasing. • OUT2 output is maintained. • One-shot output of OUT1 turns off after 0.5 seconds regardless of OUT2 output. • Count value, display value, and output are initialized upon reset input.
N	RESET MAX SV2 SV1 0 OUT1 OUT2		• When the counting value reaches the SV2 set value, counting stops and the display value is maintained. • OUT2 output is maintained. • One-shot output of OUT1 turns off after 0.5 seconds regardless of OUT2 output. • Count value, display value, and output are initialized upon reset input.
C	RESET MAX SV2 SV1 0 OUT1 OUT2		• When the counting value reaches the SV2 setting value, the counting value is displayed continuously increasing or decreasing after being initialized. • OUT2 output turns off after one-shot output. • One-shot output of OUT1 turns off after 0.5 seconds regardless of OUT2 output. • Count value, display value, and output are initialized upon reset input.
R	RESET MAX SV2 SV1 0 OUT1 OUT2		• When the counting value reaches the SV2 setting value, the counting value is stopped and displayed during the OUT2 output setting time. • The counting value is initialized after the output setting time, and the counting value is displayed continuously increasing or decreasing. • OUT2 output turns off after one-shot output. • The self-holding output of OUT1 turns OFF together with the OUT2 output. • One-shot output of OUT1 turns off after 0.5 seconds regardless of OUT2 output. • Count value, display value, and output are initialized upon reset input.
K	RESET MAX SV2 SV1 0 OUT1 OUT2		• Even if the counting value reaches the SV2 setting value, the counting value is continuously increased or decreased and displayed. • OUT2 output turns off after one-shot output. • The self-holding output of OUT1 turns OFF together with the OUT2 output. • One-shot output of OUT1 turns off after 0.5 seconds regardless of OUT2 output. • Count value, display value, and output are initialized upon reset input.
P	RESET MAX SV2 SV1 0 OUT1 OUT2		• When the counting value reaches the SV2 setting value, the counting value continues to increase or decrease after being initialized. • Count value display stops during the output set time, and increases or decreases count value is displayed after the output set time. • OUT2 output turns off after one-shot output. • The self-holding output of OUT1 turns OFF together with the OUT2 output. • One-shot output of OUT1 turns off after 0.5 seconds regardless of OUT2 output. • Count value, display value, and output are initialized upon reset input.
Q	RESET MAX SV2 SV1 0 OUT1 OUT2		• Even when the counting value reaches the SV2 set value, the counting value is displayed continuously increasing or decreasing. • Count value is initialized after OUT2 output setting time. • OUT2 output turns off after one-shot output. • The self-holding output of OUT1 turns OFF together with the OUT2 output. • One-shot output of OUT1 turns off after 0.5 seconds regardless of OUT2 output. • Count value, display value, and output are initialized upon reset input.
S	RESET MAX SV2 SV1 0 OUT1 OUT2		• In addition mode, OUT1 output is ON when 'counter value >= SV1 set value'. • In addition mode, OUT2 output is ON when 'counter value >= SV2 set value'. • When using subtraction mode, OUT1 output is ON when 'counter value <= SV1 set value'. • When using subtraction mode, OUT2 output is ON when 'counter value <= SV2 set value'. • One-shot output of OUT1 turns off after 0.5 seconds regardless of OUT2 output. • Count value, display value, and output are initialized upon reset input.
A	RESET MAX SV2 SV1 0 OUT1 OUT2		• In addition mode, OUT1 output is ON when OUT2 output is OFF and 'counter value >= SV1 set value'. • In addition mode, OUT2 output is inverted when 'counter value >= SV2 set value', and the display value is initialized. • When using subtraction mode, OUT1 output is ON when OUT2 output is OFF and 'counter value <= SV1 set value'. • When using subtraction mode, OUT2 output is inverted when 'counter value <= SV2 set value'. • One-shot output of OUT1 turns off after 0.5 seconds regardless of OUT2 output.

※ For P41T/P61T models, SV and OUT operate as SV2 and OUT2.
 ※ Apply reset signal to the front reset key or external RESET terminal.