

PRECISION MEASURING TOOLS

VERNIER CALIPERS WITH THUMB CLAMP

Thank you for purchasing the VERNIER CALIPERS WITH THUMB CLAMP

This product is a precision measurement tool with a main scale and a vernier scale to indicate the measured value.

- For safe and proper use of this product, please read this instruction manual before use and follow the procedures described. Please keep manual where it is accessible to user for future reference.
- Keep this manual with the instrument if transferred or leased to a third party.
- For inquiries about this product, please contact dealer or Niigata Seiki at the address listed on the following page.

■ PART IDENTIFICATION AND FUNCTION

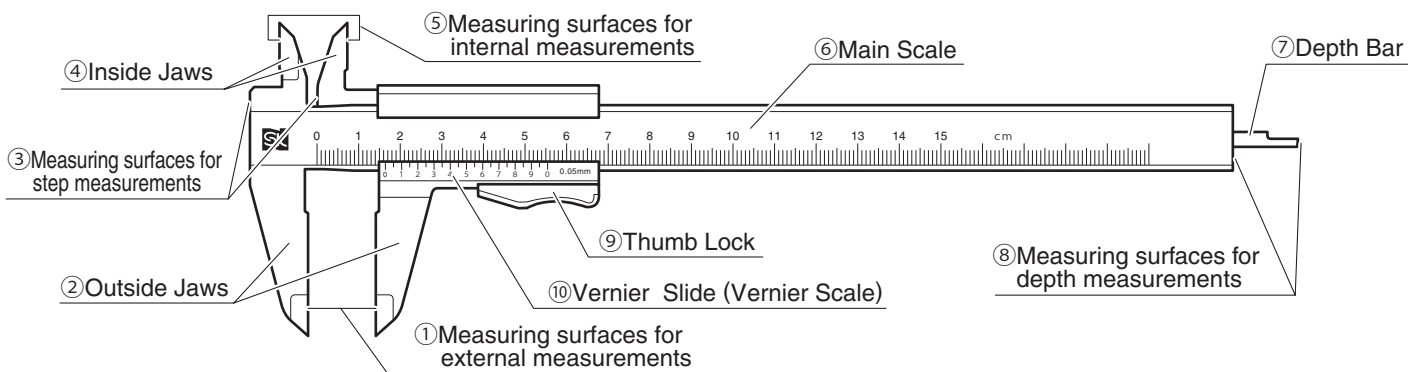

- | | |
|---|---|
| <p>① Measuring Surfaces for ... outside measurements ... Object to be measured is positioned between these surfaces.</p> <p>② Outside Jaws Measures extremal dimensions. Move Slide to open and close.</p> <p>③ Measuring surfaces for ... step measurements ... Measures the height of steps.</p> <p>④ Inside Jaws Measures internal dimensions. Move Slide to open and close.</p> <p>⑤ Measuring surfaces for ... internal measurements ... Position surfaces inside object to be measured.</p> | <p>⑥ Main Scale Indicates measured value in 1mm graduations.</p> <p>⑦ Depth Bar Bar for measuring depth. Bar moves in and out with Vernier Slide.</p> <p>⑧ Measuring surfaces for... depth measurements ... Depth is measured between these two surfaces.</p> <p>⑨ Thumb Lock Press to release Vernier Slide for taking measurement, releasing will automatically lock Slide in place.</p> <p>⑩ Vernier Slide Scale for measuring with a resolution of 0.05mm. Refer to following page for instructions on use.</p> |
|---|---|

SAFETY PRECAUTIONS

Please Observe

Always follow the proper operating procedures in order to prevent harm to yourself or others, and to prevent damage to property.

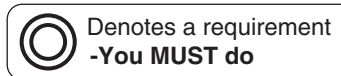
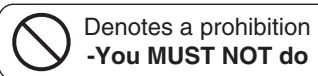

⚠ WARNING Indicates risk of **personal injury** or **property damage** if not followed.

- **Read the manual and follow the instructions.**
 - Use of product other than as described in the manual may cause accident.
- **Use only for measuring.**
 - Use for any purpose other than measuring may damage or wear the instrument. Improper use may also cause accident.
- **Handle with Care.**
 - Do not drop or subject instrument to excessive shock. Do not place under heavy objects. Improper handling may cause damage or poor accuracy.
 - Do not scratch instrument, for example by writing ID number.

- **Use in proper environment.**
 - Please do not use instrument in rain or locations with excessive humidity. Do not use at extreme high or low temperatures. Keep out of direct sunlight.
- **Jaw Tips are sharp - Handle with care.**
 - Careless handling may cause injury.
- ⊘ **Do not move the Vernier slide without pressing Thumb Lock.**
 - Excessive force applied to Slide may cause damage or affect accuracy.
- ⊘ **Do not disassemble or modify.**
 - Do not remove the vernier slide, Please do not attempt to disassemble or modify as it may cause damage or poor accuracy.

CALIBRATION

- In order to maintain instrument accuracy, it is recommended that **accuracy is confirmed through calibration on a periodic basis.** Wear of measuring surfaces from repeated use may affect accuracy and periodic accuracy checks should be performed.

We provide calibration services. Please contact agent in country of purchase to make arrangements.

PREPARATION FOR USE

Before using the caliper, follow the steps below:

- Do not apply excessive force to Vernier Slide. Pushing against slide, or attempting to move without pressing the Thumb Lock may cause damage or inaccuracy.
- Wipe off any corrosion, dirt or oil from measuring surfaces and slide. Contamination of surfaces may cause measurement error.
- Allow the caliper and object to be measured time to reach the same temperature. A temperature difference between the object to be measured and the caliper may cause measurement error. Allow enough time for the temperatures to equilibrate.

● Performing an accuracy check.

① Jaw Alignment

In closed position, make sure the measuring surfaces on the outside jaws align properly and there is no gap (no light should leak past.)

② Confirm "0" points on scale (see diagram at right)

With jaws closed as in step ① above, make sure the reading is zero and the vernier scale graduations align at the "0" and "39" positions as shown.

③ Depth Confirmation

Position caliper on a flat surface for depth measurement. Reading should be "0" as in step ② above, with the vernier graduations aligned at the "0" and "39" positions.

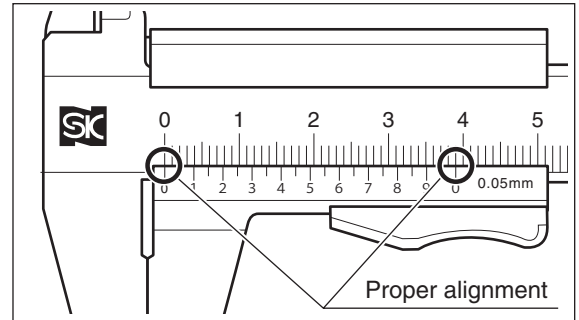

READING THE SCALE

The measured value is determined by reading the main scale, and then adding the Vernier Scale reading as determined by the position where the vernier and main scale graduations align.

$$\text{Measured value} = \text{Main Scale Reading} + \text{Vernier Scale Reading}$$

● EXAMPLE 1 Measured Value: 77.00mm

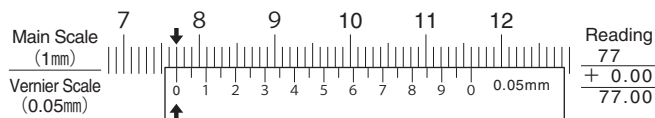

● EXAMPLE 2 Measured Value: 77.30mm

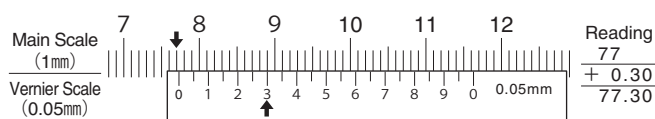

● EXAMPLE 3 Measured Value: 77.35mm

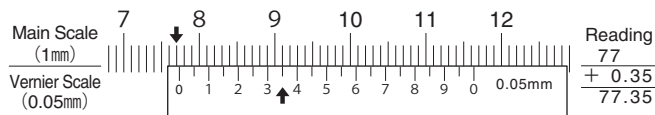

AFTER USE CARE, STORAGE NOTES

- As required, wipe slide and measuring surfaces with a dry cloth treated with anti-corrosive oil. When not in use, apply anti-corrosive treatment or keep in anti-corrosive bag.
- When not in use, keep jaws slightly open to prevent thermal expansion from creating excessive forces on jaws and affecting accuracy.
- Store in supplied case when not in use in a cool, dry location.

PREVENTING ERRORS

In order to prevent measurement error, please note the following.

POSITIONING CALIPER ON OBJECT

<Flat surfaces>

When measuring features with flat surfaces, make sure the measuring surface of the jaws are parallel to the surfaces to be measured.

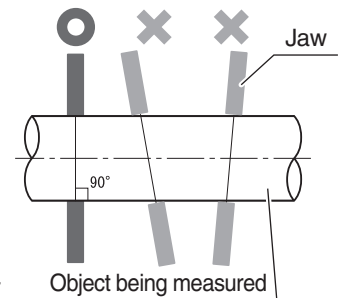

<Cylindrical surfaces>

When measuring cylindrical features, make sure the caliper jaws are perpendicular to the cylinder axis as shown.

VIEWING THE SCALE

Scale should be read from directly above the calipers. Due to step in height of vernier scale relative to main scale, if viewing direction is not directly above the reading may have parallax error.

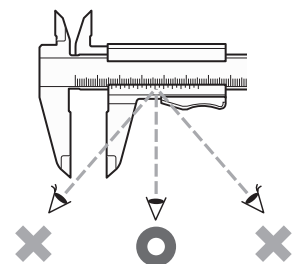

SPECIFICATIONS

- Material : Stainless Steel

Model No.	GHS-15	GHS-20
Measuring Range	0~150mm	0~200mm
Resolution	0.05mm	
Accuracy	±0.05mm	

SK Niigata seiki Co., Ltd.

6-15-22, Tsukanome, Sanjo, Niigata, Japan, 955-0055
 Tel. : +81-256-31-5660 Fax. : +81-256-39-7730
 MAIL: intl.sales@niigataseiki.co.jp
 URL http://www.niigataseiki.co.jp