

HG-SERIES

Molded Case Circuit Breakers & Earth Leakage Circuit Breakers



LV & MV Circuit Breakers

MOLDED CASE CIRCUIT BREAKERS & EARTH LEAKAGE CIRCUIT BREAKERS

CONTENTS

16 External Structure and Contents of Nameplate / 18 Standards and Certifications /
19 Products Selection Table / 33 Accessories / 53 Technical Information /
69 Characteristic Curves & Dimensions / 121 Order Information / 158 Maintenance and Certifications

HG-SERIES

Globalization of Technology

HG-SERIES

Molded Case Circuit Breakers & Earth Leakage Circuit Breakers

Maximized Selectivity and Safety with Various Products Range & Breaking Capacity!

Various Product Range 32 - 800 AF

Reinforced Breaking Capacity 16 - 85 kA (at 460 V)

$I_{cs} = 100\% I_{cu}$

Rated Insulation Voltage (U_i) 1,000 V





HYUNDAI
HGM 100H

100AF 50/60Hz 40°C
Ui 1000V Uimp 8kV
Ue(V) Icu(kA)
660 / 690V - 75kA
480 / 500V - 14kA
440 / 460V - 26kA
380 / 415V - 26kA
220 / 240V - 50kA
Ics = Icu 75%

MADE IN KOREA

ON

100A

CE Cat. A
IEC 60947-2



PUSH TO TRIP

1.0 + 0.8
0.9 Ir(x In)

LOAD

HG-SERIES

Adjustable Ratings Design

Optimized Protection Based on the Load Conditions!

Adjustable Rated Currents (Molded Case Circuit Breakers)

32 - 250 AF (0.8 - 0.9 - 1 X In), 400 - 800 AF (0.63 - 0.8 - 1 X In)

Adjustable Rated Residual Currents (Earth Leakage Circuit Breakers)

100 - 300 - 500 - 1,000 (mA)

Adjustable Residual Current Off-Time (Earth Leakage Circuit Breakers)

0 - 200 - 500 - 1,000 (ms)

Reinforcement of Protective Coordination

Rated Short-Circuit Current by AF, (Ics = 100 % Icu, at 440/460 V)

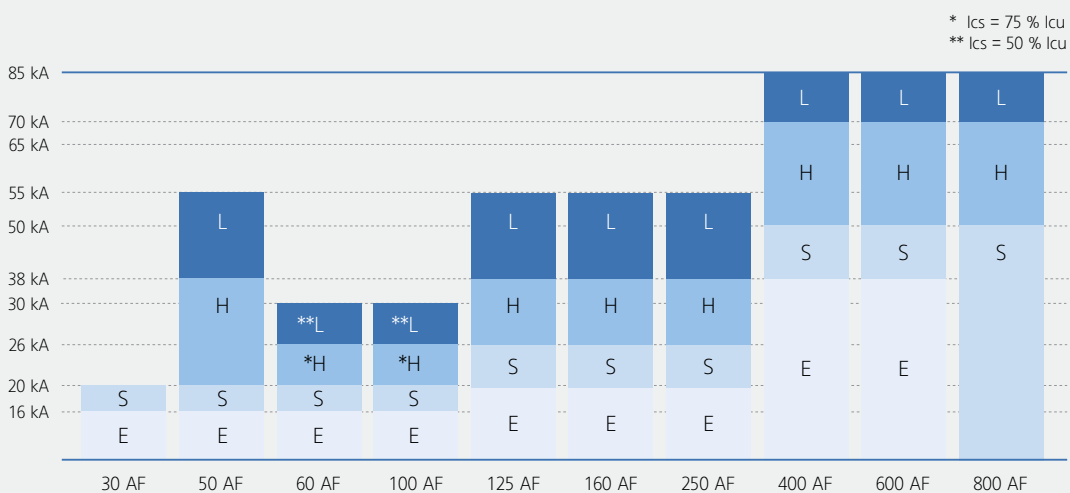

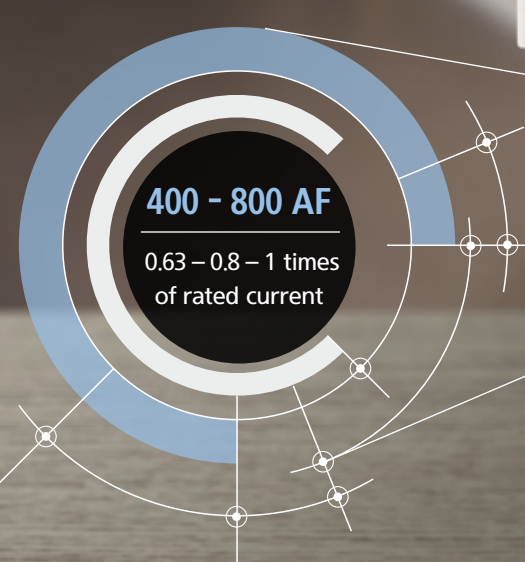

HG-SERIES

Advanced Breaking Performance and Various Selectivity

- Various Product Range: 32 - 800 AF, 10 Frames
- Standardized Size of Accessories, Compatible with MCCB and ELCB
- Standardized Height of Products by Frame: 32 - 250 AF (68 mm), 400 - 800 AF (110 mm)

32, 50, 63, 100 AF

50, 125 AF

160, 250 AF



Size
Compatibility
Public Using
Accessories

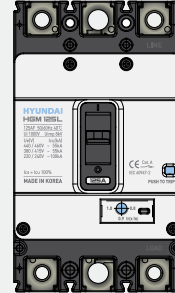

MCCB

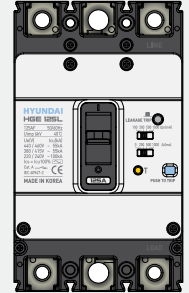

ELCB

400 AF

630, 800 AF

(unit: mm)



HG-SERIES

HGM Type Molded Case Circuit Breakers

Ui: 1,000 V Uimp: 8 kV Ics = 100 % Icu

Maximized Insulation Performance

- Rated insulation voltage, Ui: 1,000 V
- Rated impulse withstand voltage, Uimp: 8 kV

High Breaking Capacity

- 16 - 30 kA at 460 V (100 AF)
- 20 - 55 kA at 460 V (125 - 250 AF)
- 38 - 85 kA at 460 V (400 - 800 AF)

Cable Insulation Performance Suitability

In case of continuing abnormal conditions such as welding of main contact after trip, handle is not available to move 'OFF position' in accordance with IEC 60947-2 cable insulation performance. Also, it is possible to maintain easily by checking a contact condition by the handle.

Adjustable Rated Current

As applying to adjustable rated current design, it is possible to protect circuit optimally according to the load factor. Adjustable range of rated currents.

(Molded case circuit breakers)

- 30 - 250 AF: 80 % - 90 % - 100 % of rated current
- 400 - 800 AF: 63 % - 80 % - 100 % of rated current

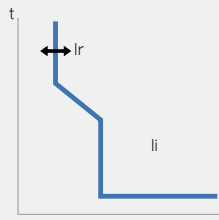

Characteristic Curve
(I - t Curve)

Dial Sealing Device (Option)

Prevent removal of the protection cover from body and any operating of current setting value.

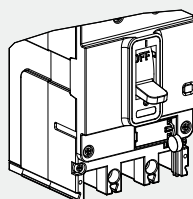

HGM 125H

125AF 50/60Hz 40 °C
Ui 1000V Uimp 8kV

Ue(V)	Icu(kA)
660 / 690V	~ 8kA
480 / 500V	~ 26kA
440 / 460V	~ 38kA
380 / 415V	~ 38kA
220 / 240V	~ 85kA
Ics = Icu 100%	

CE Cat. A
IEC 60947-2



PUSH TO TRIP





HG-SERIES

HGM Type Molded Case Circuit Breakers

- High Performance & Coordination

Service Breaking Capacity ($I_{cs} = 100\% \times I_{cu}$)

Service breaking capacity, '100 % X I_{cu}' is realized by enlarging breaking capacity with internal limit current device.

- 32 - 800 AF
 - 16 - 55 kA @ 460 Vac (Up to 250 AF)
 - 38 - 85 kA @ 460 Vac (400 - 800 AF)
- (HGM60, 100 H Type $I_{cs} = 75\% I_{cu}$, HGM60, 100 AF L Type $I_{cs} = 50\% I_{cu}$)

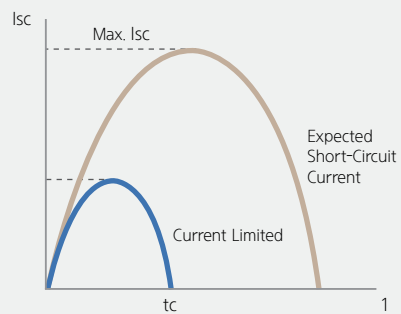

Current Limiting Characteristics

Available to Various Low Voltage System Protections

It is available to adapt various low voltage system protections such as 'Discrimination' and 'Cascading' with limit current characteristic and high breaking capacity.

Discrimination

It is a low voltage system protection to selectively separate fault point from system to minimize influence of fault. In this protection type, only circuit breaker installed at a fault point is operated while the other feeder can be used continuously.

Cascading

In this protection type, upstream circuit breakers can be tripped earlier than downstream circuit breaker for back up protection. So, it is applied to the smaller breaking capacity than the calculated value at down stream circuit.

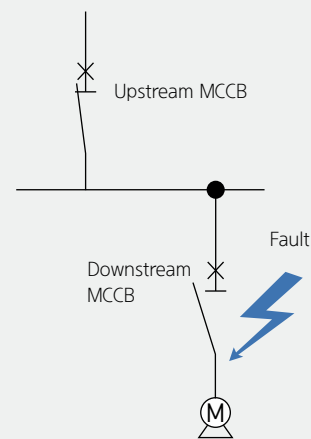



Various Low
Voltage System
Protections

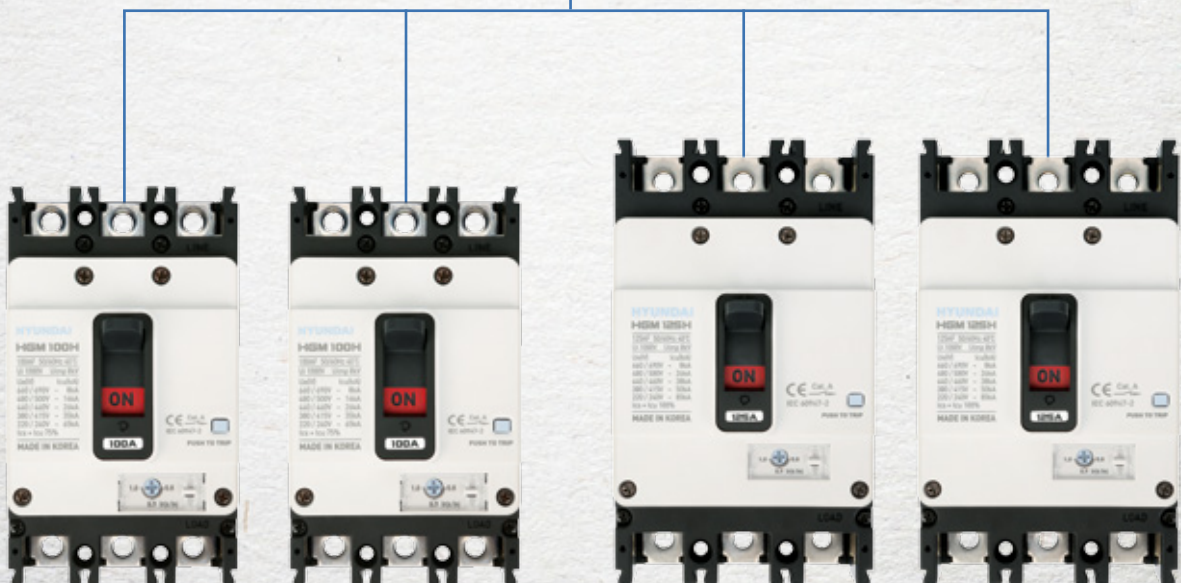

HG-SERIES

HGM Type Earth Leakage Circuit Breakers

$I_{cs} = 100 \% I_{cu}$ $U_{imp} = 6 \text{ kV}$

- Standardized Size of Accessories, Compatible with MCCB
- Adjustable Residual Current and Current Cut-Off Time
- Application of 3 Phase Power Supply System, Enabling Normal Operation Under One Phase Loss Fault Adopt to EN Standards



Dimensions and Specifications Compatibility with MCCB

- Service breaking capacity, $I_{cs} = 100 \% I_{cu}$
- Rated impulse withstand voltage, $U_{imp}: 6 \text{ kV}$

Residual Current Protection Characteristics

- Prevent damage from reverse connection: It is possible to prevent circuit damage under reverse connection condition.
- Prevent unnecessary malfunction on temporary leakage condition.
- Adjustable residual current and cut-off time.
- 3 Phase power supply system: Enables normal operation under one phase loss condition by adapting 3 phase power supply system.
- Protecting an inverter load safely from ground fault by adapting IC filter.

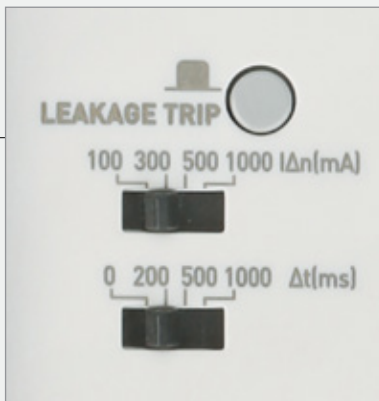

Adjustable Residual Current and Cut-Off Time

Part	Adjustable Residual Current					Cut-Off Time			
	30 mA	100 mA	300 mA	500 mA	1,000 mA	0 ms	200 ms	500 ms	1,000 ms
Previous ELCB	Fixed	3 steps			-	Fixed	-	-	-
HG-ELCB	Fixed	4 steps				4 steps			

- Adjustable residual current and cut-off time in 4 steps.
- Coordination protection between upstream and downstream circuit breakers by adjusting residual current and cut-off line.

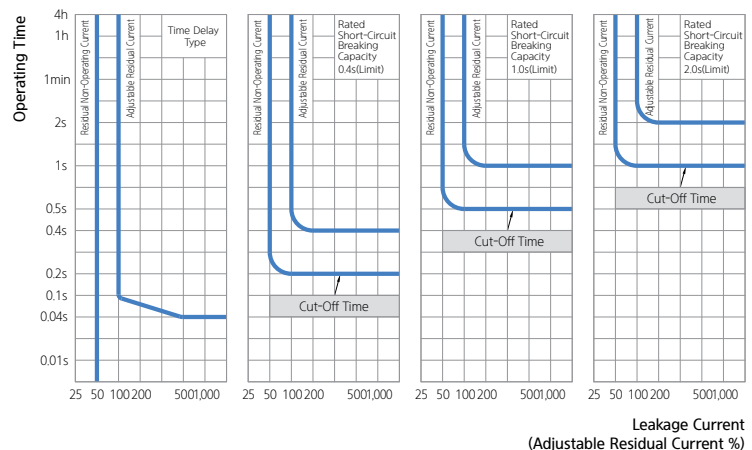

External Structure and Contents of Nameplate

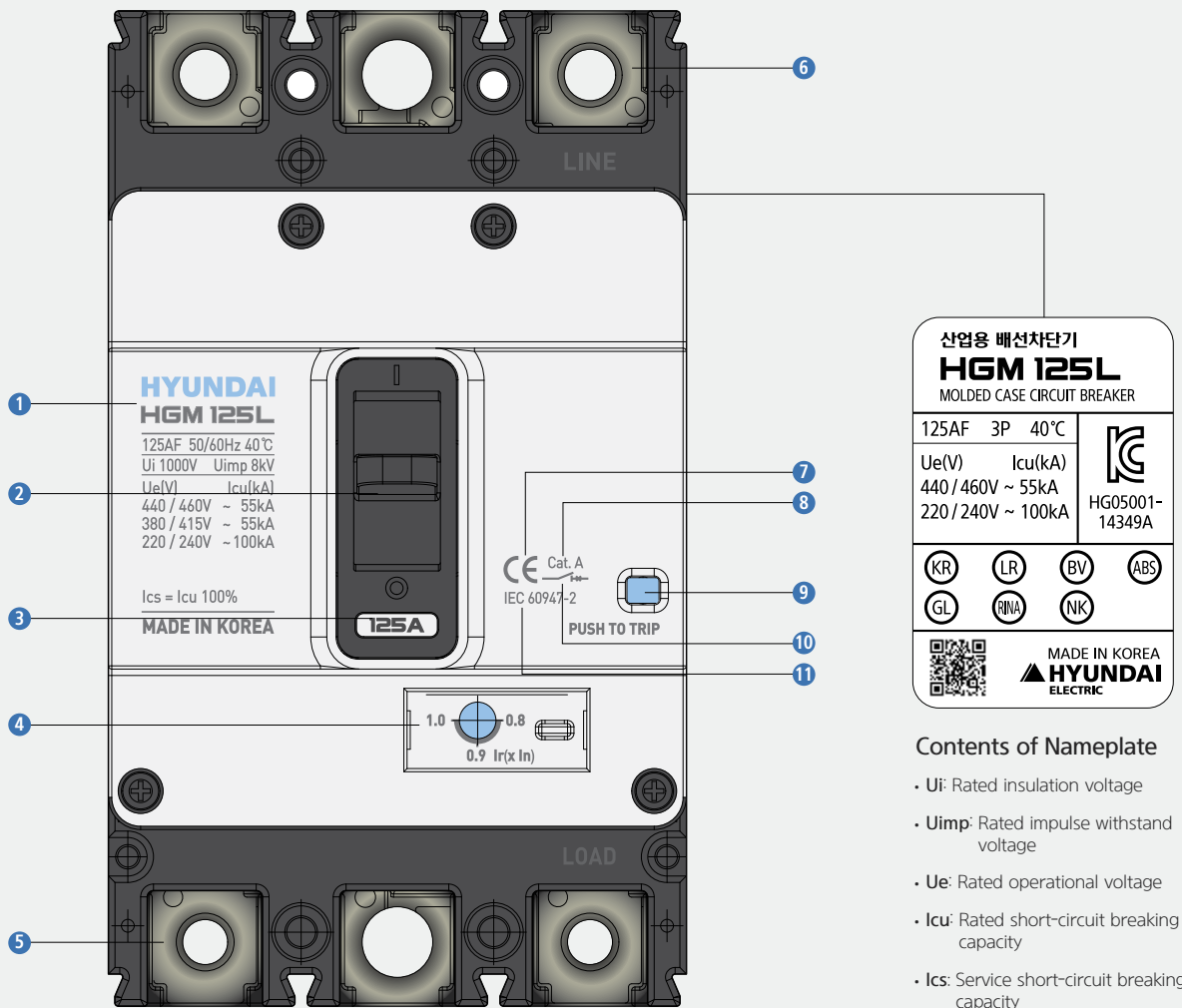
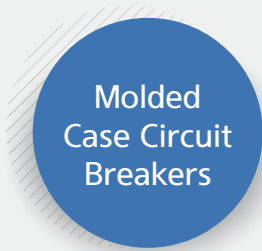





- Contents of Nameplate**
- **Ui**: Rated insulation voltage
 - **Uimp**: Rated impulse withstand voltage
 - **Ue**: Rated operational voltage
 - **Icu**: Rated short-circuit breaking capacity
 - **Ics**: Service short-circuit breaking capacity

Molded Case Circuit Breakers (MCCB)

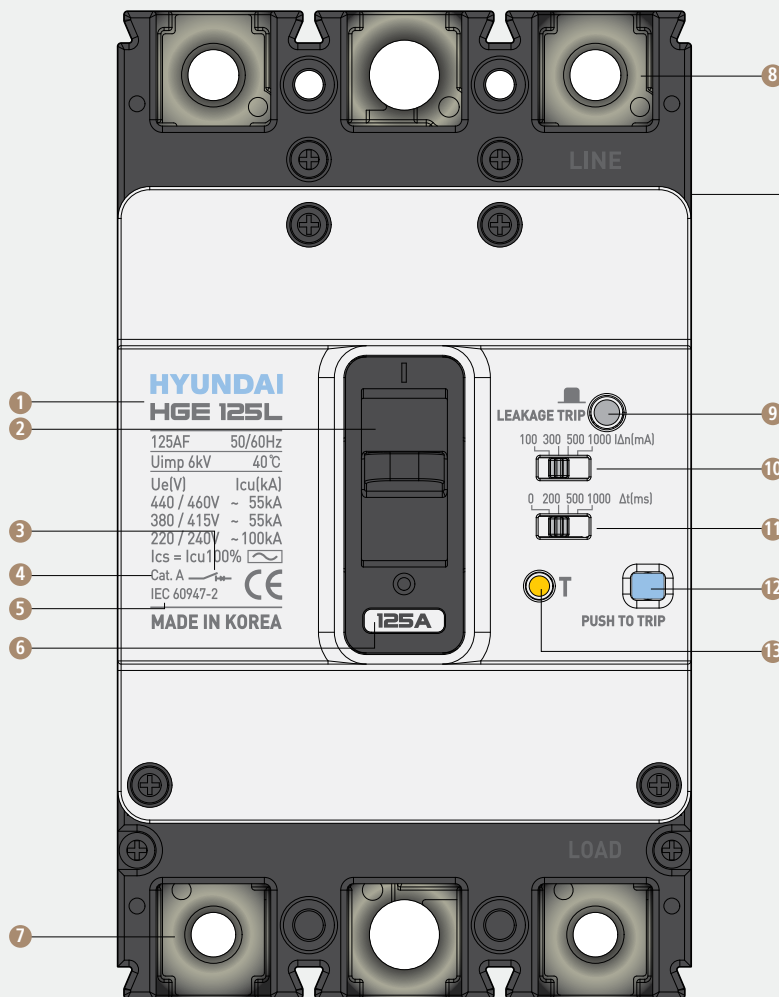
- | | | |
|--------------------|------------------------|--|
| ① Model Name | ⑤ Load Side Terminal | ⑨ Trip Button |
| ② Operating Handle | ⑥ Line Side Terminal | ⑩ Cable Insulation Performance Suitability |
| ③ Rated Current | ⑦ CE Marking | ⑪ Standards |
| ④ Adjusting Knob | ⑧ Utilization Category | |

Earth Leakage Circuit Breakers



산업용 누전차단기			 HG05001-14347A
HGE 125L			
EARTH LEAKAGE CIRCUIT BREAKER			
125A	3P	40°C	
Ue(V)	Icu(kA)		
440 / 460V ~ 55kA			
380 / 415V ~ 55kA			
220 / 240V ~ 100kA			
Ics = Icu100%			
Cat. A			
IEC 60947-2			
MADE IN KOREA			
			
MADE IN KOREA			
			

Contents of Nameplate

- **U_i**: Rated insulation voltage
- **U_{imp}**: Rated impulse withstand voltage
- **U_e**: Rated operational voltage
- **I_{cu}**: Rated short-circuit breaking capacity
- **I_{cs}**: Service short-circuit breaking capacity

Earth Leakage Circuit Breakers (ELCB)

- | | | |
|--|--------------------------|--|
| ① Model Name | ⑤ CE Marking | ⑩ Rated Residual Current Setting Switch |
| ② Operating Handle | ⑥ Rated Current | ⑪ Rated Residual Current Cut-Off Time Setting Switch |
| ③ Cable Insulation Performance Suitability | ⑦ Load Side Terminal | ⑫ Trip Test Button |
| ④ Utilization Category | ⑧ Line Side Terminal | ⑬ Leakage Trip Test Button |
| | ⑨ Leakage Trip Indicator | |

Standards and Certifications

Standards

Standards

KS C 8321

Molded case circuit breakers for industrial uses

KS C 4613

Circuit breaker incorporating residual current protection for industrial Uses (CBR)

International Standards

IEC 60947-1

Low voltage switchgear and controlgear, part 1 (General rules)

IEC 60947-2

Low voltage switchgear and controlgear, part 2 (Circuit breakers)



Approvals and Certifications

HG-Series MCCB has acquired the certification from the TEST agency registered in STL.

- CB certification (DEKRA)
- Safety certification scheme for electrical applications
- KS (Korean industrial standards)
- Marine approvals (8's classifications)



Vibration/Shock Withstand Test Certification Acquisition

HG Series MCCB has acquired the vibration/shock withstand test certification in accordance with IEC 60068-2-6 standard which is the required level of IACS, international vessel inspection institute.

- Vibration resistant: 2 - 13.2 Hz - ± 1 mm
- Shock resistant: 13.2 - 100 Hz - ± 0.7 g

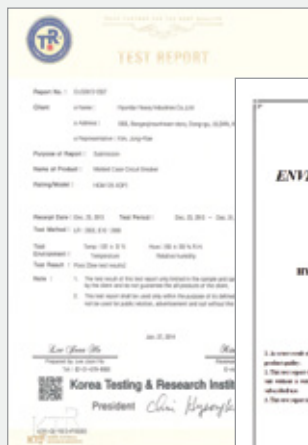

Our services

Testing, inspections, certification

DEKRA provides certification of management systems as well as technical support, testing and certification of a wide range of products throughout the life cycle.

Products Selection Table

Molded Case Circuit Breakers (HGM Type)	20
ZCT Molded Case Circuit Breakers (ZCT / HGM Type)	24
Earth Leakage Circuit Breakers (HGE Type)	28

Model Selection Table

MCCB (HGM Type): 32 - 250 AF

Things in Common

Rated Insulation Voltage, U_i	1,000 V
Rated Operational Voltage, U_e	690 V
Impulse Withstand Voltage, U_{imp}	8 kV
Protective Function	Overload, short-circuit and instantaneous protection

Suitability for Isolation	Yes
Utilization Category	A
Polution Degree	3
Reference Standard	IEC 60947-2

Model	HGM30		HGM50				HGM60						
Frame (AF)	32		50				63						
Pole (P)	2, 3, 4 ¹⁾		2, 3, 4 ¹⁾				2, 3, 4 ¹⁾						
Rated current, at 40 °C (A)	16, 20, 25, 32		16, 20, 25, 32, 40, 50				16, 20, 25, 32, 40, 50, 63						
Rated short-circuit breaking capacity [Icu] (kA rms)	Recognition code for order		E	S	E	S	H	L	E	S	H	L	
	AC660/690 V		2.5	5	2.5	5	8	10	2.5	5	7.5	8	
	AC480/500 V		7.5	10	7.5	10	26	35	7.5	10	14	26	
	AC440/460 V		16	20	16	20	38	55	16	20	26	30	
	AC380/415 V		16	20	16	20	38	55	16	20	26	30	
AC220/240 V		35	50	35	50	85	100	35	50	50	50		
DC250 V (2P)		5	10	5	10	20	30	5	10	15	15		
Service breaking capacity [Ics = % Icu]		100	100	100	100	100	100	100	100	75	50		
Endurance (Durability)	Mechanical		30,000		30,000				30,000				
	Electrical		10,000		10,000				10,000				
Trip Device													
Thermal magnetic	Long time [LT]	Fixed	(1.0) x In		(1.0) x In				(1.0) x In				
		Adjustable	(0.8 - 0.9 - 1.0) x In		(0.8 - 0.9 - 1.0) x In				(0.8 - 0.9 - 1.0) x In				
	Instantaneous [INST]		400 A		16 - 32 A: 400 A, 40 - 50 A: 10 x In				16 - 32 A: 400 A, 40 - 63 A: 10 x In				
Accessory													
Internal	Auxiliary switch AUX		●		●				●				
	Alarm switch ALT		●		●				●				
	Shunt trip SHT		●		●				●				
	Undervoltage trip UVT		●		●				●				
External	Rotary handle	Front contact TFG	●		●				●				
		Extended TFH	●		●				●				
	Motor operator MOT		●		●				●				
	Mechanical interlock MIF		●		●				●				
	Locking device PLD		●		●				●				
	Plug-in	TDM (LINE/LOAD)		● (3P Only)		● (3P Only)		● (3P Only)		● (3P Only)			
		TDM (LINE only)		● (3P Only)		● (3P Only)		● (3P Only)		● (3P Only)			
		TDF (LINE only)		● (3P Only)		● (3P Only)		● (3P Only)		● (3P Only)			
		TDA (1 row)		● (3P Only)		● (3P Only)		● (3P Only)		● (3P Only)			
		TDA (2 row)		● (2, 3P Only)		● (2, 3P Only)		● (3P Only)		● (2, 3P Only)			
Cage terminal block CTB		●		●				●					
Insulation terminal cover TCF		●		●				●					
Insulation barrier TQQ		●		●				●					
Terminal extensions TBB		-		-				-					
Installation and Dimensions													
Connection/Installation	Front connection		Terminal screw										
	Rear connection		Horizontal/Vertical										
	Plug-in		Switchboard type (Line & Load, Line only), Distribution board type ²⁾										
	DIN rail installation		Possible for using DIN rail adapter			-			Possible for using DIN rail adapter				
Dimensions (mm)		a (2/3/4P)		50/75/100	50/75/100	60/90/120	50/75/100						
		b		130	130	155	130						
		c		68	68	68	68						
Weight (kg)	2/3/4P		0.6/0.8/1.0	0.6/0.8/1.0	0.8/1.0/1.3	0.6/0.8/1.0							
Detailed rating and select		122 Page		122 Page				122 Page					
Characteristics curve and outside view		70 - 80 Page		70 - 80 Page				70 - 80 Page					

※ ¹⁾ 4 pole arrangement: Basic specification is R-S-T-N (N-R-S-T is optional).

²⁾ Plug-in: Applicable only 3P.

³⁾ 2P product is just removed versus central pole of 3P product. So, 2P product's dimension is equal to 3P product's dimension.



HGM100				HGM125				HGM160				HGM250			
100				125				160				250			
2, 3, 4 ¹⁾				2, 3, 4 ¹⁾				2 ³⁾ , 3, 4 ¹⁾				2 ³⁾ , 3, 4 ¹⁾			
16, 20, 25, 32, 40, 50, 63, 75, 80, 100				16, 20, 25, 32, 40, 50, 63, 75, 80, 100, 125				100, 125, 150, 160				100, 125, 150, 160, 175, 200, 225, 250			
E	S	H	L	E	S	H	L	E	S	H	L	E	S	H	L
2.5	5	7.5	8	5	7.5	8	10	7.5	8	8	10	7.5	8	8	10
7.5	10	14	26	10	14	26	35	14	20	26	35	14	20	26	35
16	20	26	30	20	26	38	55	20	26	38	55	20	26	38	55
16	20	26	30	20	26	38	55	20	26	38	55	20	26	38	55
35	50	50	50	50	65	85	100	50	65	85	100	50	65	85	100
5	10	15	15	10	15	20	30	10	15	20	30	10	15	20	30
100	100	75	50	100	100	100	100	100	100	100	100	100	100	100	100
30,000				30,000				25,000				25,000			
10,000				10,000				10,000				10,000			
(1.0) x In				(1.0) x In				(1.0) x In				(1.0) x In			
(0.8 - 0.9 - 1.0) x In				(0.8 - 0.9 - 1.0) x In				(0.8 - 0.9 - 1.0) x In				(0.8 - 0.9 - 1.0) x In			
16 - 32 A: 400 A, 40 - 100 A: 10 x In				16 - 32 A: 400 A, 40 - 125 A: 10 x In				10 x In				10 x In			
●				●				●				●			
●				●				●				●			
●				●				●				●			
●				●				●				●			
●				●				●				●			
●				●				●				●			
●				●				●				●			
●				●				●				●			
●				●				●				●			
●				●				●				●			
● (3P Only)				● (3P Only)				● (3P Only)				● (3P Only)			
● (3P Only)				● (3P Only)				● (3P Only)				● (3P Only)			
● (3P Only)				● (3P Only)				-				-			
● (3P Only)				● (3P Only)				-				-			
● (2, 3P Only)				● (3P Only)				-				-			
●				●				●				●			
●				●				●				●			
●				●				●				●			
-				-				●				●			
Terminal screw				Terminal screw				Terminal screw, Terminal busbar				Terminal screw, Terminal busbar			
Horizontal/Vertical				Horizontal/Vertical				Horizontal/Vertical				Horizontal/Vertical			
Switchboard type (Line & Load, Line only), Distribution board type ²⁾				Switchboard type (Line & Load, Line only), Distribution board type ²⁾				Switchboard type (Line & Load, Line only) ²⁾				Switchboard type (Line & Load, Line only) ²⁾			
Possible for using DIN rail adapter				-				-				-			
50/75/100				60/90/120				105/105/140				105/105/140			
130				155				165				165			
68				68				68				68			
0.6/0.8/1.0				0.8/1.0/1.3				1.1/1.3/1.7				1.1/1.3/1.7			
122 Page				122 Page				122 Page				122 Page			
70 - 80 Page				70 - 80 Page				70 - 80 Page				70 - 80 Page			

Model Selection Table

MCCB (HGM Type): 400 - 800 AF

Things in Common

Rated Insulation Voltage, U_i	1,000 V	Suitability for Isolation	Yes
Rated Operational Voltage, U_e	690 V	Utilization Category	A
Impulse Withstand Voltage, U_{imp}	8 kV	Polution Degree	3
Protective Function	Overload, short-circuit and instantaneous protection	Reference Standard	IEC 60947-2

Model	HGM400				HGM630				HGM800						
Frame (AF)	400				630				800						
Pole (P)	2, 3, 4 ¹⁾				2, 3, 4 ¹⁾				2, 3, 4 ¹⁾						
Rated current, at 40 °C (A)	250, 300, 350, 400				500, 630				700, 800						
Rated short-circuit breaking capacity [Icu] (kA rms)	Recognition code for order	E	S	H	L	E	S	H	L	S	H	L			
	AC660/690 V	5	8	10	14	5	8	10	14	5	8	10			
	AC480/500 V	18	35	50	65	25	45	50	65	45	50	65			
	AC440/460 V	38	50	70	85	38	50	70	85	50	70	85			
	AC380/415 V	45	65	85	100	45	65	85	100	65	85	100			
Service breaking capacity [Ics = % Icu]	AC220/240 V	50	75	100	125	50	75	100	125	75	100	125			
	DC250 V (2P)	20	25	40	40	20	25	40	40	25	40	40			
Endurance (Durability)	Mechanical	4,000				2,500				2,500					
	Electrical	1,000				500				500					
Trip Device															
Thermal magnetic	Long time [LT]	Fixed	(1.0) x In				(1.0) x In				(1.0) x In				
		Adjustable	(0.63 - 0.8 - 1.0) x In				(0.63 - 0.8 - 1.0) x In				(0.63 - 0.8 - 1.0) x In				
	Instantaneous [INST]	10 x In				10 x In				10 x In					
Accessory															
Internal	Auxiliary switch	AUX	●				●				●				
	Alarm switch	ALT	●				●				●				
	Shunt trip	SHT	●				●				●				
	Undervoltage trip	UVT	●				●				●				
External	Rotary handle	Front contact	TFG	●				●				●			
		Extended	TFH	●				●				●			
	Motor operator	MOT	●				●				●				
	Mechanical interlock	MIF	●				●				●				
	Locking device	PLD	●				●				●				
	Plug-in	TDM (LINE/LOAD)	● (3P Only)				● (3P Only)				● (3P Only)				
		TDM (LINE only)	● (3P Only)				● (3P Only)				● (3P Only)				
		TDF (LINE only)	-				-				-				
		TDA (1 row)	-				-				-				
	TDA (2 row)	-				-				-					
Cage terminal block	CTB	●				●				●					
Insulation terminal cover	TCF	●				●				●					
Insulation barrier	TQQ	●				●				●					
Terminal extensions	TBB	●				●				●					
Installation and Dimensions															
Connection/Installation	Front connection	Terminal screw				Terminal screw, Terminal busbar									
	Rear connection	Horizontal/Vertical wiring				Horizontal/Vertical wiring									
	Plug-in	Switchboard type (Line & Load, Line only) ²⁾				Switchboard type (Line & Load, Line only) ²⁾									
Dimensions (mm)		a (2/3/4P)	140/140/184				210/210/280				210/210/280				
		b	257				280				280				
		c	110				110				110				
Weight (kg)	2/3/4P	4/4.5/5.4				8.7/9.5/12.5				8.7/9.5/12.5					
Detailed rating and select	122 Page														
Characteristics curve and outside view	70 - 80 Page														

※ ¹⁾ 4 pole arrangement: Basic specification is R-S-T-N (N-R-S-T is optional).

²⁾ Plug-in: Applicable only 3P.

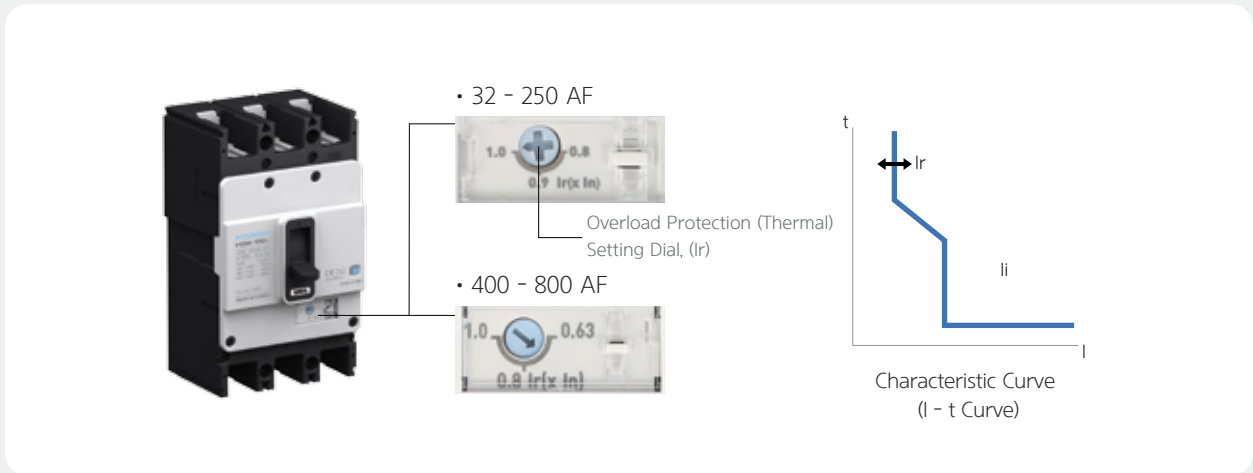

Trip Unit Characteristics - Thermal Magnetic

Rated Current (A) [In]		16	20	25	32	40	50	63	75	80	100	125
MCCB	HGM30	●	●	●	●							
	HGM50	●	●	●	●	●	●					
	HGM60	●	●	●	●	●	●	●				
	HGM100	●	●	●	●	●	●	●	●	●	●	
	HGM125	●	●	●	●	●	●	●	●	●	●	●
Time Pick-Up Characteristics [Ir]												
Settings (A)		16	20	25	32	40	50	63	75	80	100	125
	0.8 x In	12.8	16	20	25.6	32	40	50.4	60	64	80	100
	0.9 x In	14.4	18	22.5	28.8	36	45	56.7	67.5	72	90	112.5
	1.0 x In	16	20	25	32	40	50	63	75	80	100	125
Instantaneous Pick-Up Characteristics [Ii]												
Settings (A)	10 x In	400			400	500	630	750	800	1,000	1,250	
	Instantaneous pick-up characteristics (A)	320			320	400	504	600	640	800	1,000	
	The minimum operating current (A)	480			480	600	756	900	960	1,200	1,500	
Neutral Pole Protection												
4P3D	Unprotected											
4P4D	-											

Rated Current (A) [In]		100	125	150	160	175	200	225	250
MCCB	HGM160	●	●	●	●				
	HGM250	●	●	●	●	●	●	●	●
Time Pick-Up Characteristics [Ir]									
Settings (A)	Fixed	100	125	150	160	175	200	225	250
	0.8 x In	80	100	120	128	140	160	180	200
	0.9 x In	90	112.5	135	144	157.5	180	202.5	225
	1.0 x In	100	125	150	160	175	200	225	250
Instantaneous Pick-Up Characteristics [Ii]									
Settings (A)	10 x In	1,000	1,250	1,500	1,600	1,750	2,000	2,250	2,500
	Instantaneous pick-up characteristics (A)	800	1,000	1,200	1,280	1,400	1,600	1,800	2,000
	The minimum operating current (A)	1,200	1,500	1,800	1,920	2,100	2,400	2,700	3,000
Neutral Pole Protection									
4P3D	Unprotected								
4P4D	-								

Rated Current (A) [In]		250	300	350	400	500	630	700	800
MCCB	HGM400	●	●	●	●				
	HGM630					●	●		
	HGM800							●	●
Time Pick-Up Characteristics [Ir]									
Settings (A)	Fixed	250	300	350	400	500	630	700	800
	0.63 x In	158	189	221	252	315	397	441	504
	0.8 x In	200	240	280	320	400	504	560	640
	1.0 x In	250	300	350	400	500	630	700	800
Instantaneous Pick-Up Characteristics [Ii]									
Settings (A)	10 x In	2,500	3,000	3,500	4,000	5,000	6,300	7,000	8,000
	Instantaneous pick-up characteristics (A)	2,000	2,400	2,800	3,200	4,000	5,040	5,600	6,400
	The minimum operating current (A)	3,000	3,600	4,200	4,800	6,000	7,560	8,400	9,600
Neutral Pole Protection									
4P3D	Unprotected								
4P4D	-								

Model Selection Table

ZCT MCCB (HGM Type): 32 - 250 AF

Mounted with a ZCT (Zero phase Current Transformer) at MCCB, the reliability of the MCCB's ground fault protection is improved by linking with an external ELR.

Things in Common

Rated Insulation Voltage, U_i	1,000 V	Suitability for Isolation	Yes
Rated Operational Voltage, U_e	690 V	Utilization Category	A
Impulse Withstand Voltage, U_{imp}	8 kV	Pollution Degree	3
Protective Function	Overload, short-circuit and instantaneous protection	Reference Standard	IEC 60947-2

Model		HGM30		HGM50				HGM60				
Frame	(AF)	32		50				63				
Pole	(P)	2 ³⁾ , 3, 4 ¹⁾		2 ³⁾ , 3, 4 ¹⁾				2 ³⁾ , 3, 4 ¹⁾				
Rated current, at 40 °C	(A)	16, 20, 25, 32		16, 20, 25, 32, 40, 50				16, 20, 25, 32, 40, 50, 63				
Rated short-circuit breaking capacity [Icu] (kA rms)	Recognition code for order	E	S	E	S	H	L	E	S	H	L	
	AC660/690 V	2.5	5	2.5	5	8	10	2.5	5	7.5	8	
	AC480/500 V	7.5	10	7.5	10	26	35	7.5	10	14	26	
	AC440/460 V	16	20	16	20	38	55	16	20	26	30	
	AC380/415 V	16	20	16	20	38	55	16	20	26	30	
	AC220/240 V	35	50	35	50	85	100	35	50	50	50	
Service breaking capacity [Ics = % Icu]		100	100	100	100	100	100	100	100	75	50	
Endurance (Durability)	Mechanical	30,000		30,000				30,000				
	Electrical	10,000		10,000				10,000				
ZCT Output characteristic		200 mA/100 mV		200 mA/100 mV				200 mA/100 mV				
Trip Device												
Thermal magnetic	Long time [LT]	(1.0) x In		(1.0) x In				(1.0) x In				
	Instantaneous [INST]	400 A		16 - 32 A: 400 A, 40 - 50 A: 10 x In				16 - 32 A: 400 A, 40 - 63 A: 10 x In				
Accessory												
Internal	Auxiliary switch	AUX	●	●				●				
	Alarm switch	ALT	●	●				●				
	Shunt trip	SHT	●	●				●				
	Undervoltage trip	UVT	●	●				●				
External	Rotary handle	Front contact	TFG	●	●				●			
		Extended	TFH	●	●				●			
	Motor operator	MOT	●	●				●				
	Mechanical interlock	MIF	●	●				●				
	Locking device	PLD	●	●				●				
	Plug-in	TDM (LINE/LOAD)	● (3P Only)	● (3P Only)	● (3P Only)	● (3P Only)	● (3P Only)	● (3P Only)	● (3P Only)	● (3P Only)	● (3P Only)	● (3P Only)
		TDM (LINE only)	● (3P Only)	● (3P Only)	● (3P Only)	● (3P Only)	● (3P Only)	● (3P Only)	● (3P Only)	● (3P Only)	● (3P Only)	● (3P Only)
		TDF (LINE only)	● (3P Only)	● (3P Only)	● (3P Only)	● (3P Only)	● (3P Only)	● (3P Only)	● (3P Only)	● (3P Only)	● (3P Only)	● (3P Only)
		TDA (1 row)	● (3P Only)	● (3P Only)	● (3P Only)	● (3P Only)	● (3P Only)	● (3P Only)	● (3P Only)	● (3P Only)	● (3P Only)	● (3P Only)
		TDA (2 row)	● (2, 3P Only)	● (2, 3P Only)	● (2, 3P Only)	● (2, 3P Only)	● (2, 3P Only)	● (2, 3P Only)	● (2, 3P Only)	● (2, 3P Only)	● (2, 3P Only)	● (2, 3P Only)
	Cage terminal block	CTB	●	●				●				
	Insulation terminal cover	TCF	●	●				●				
Insulation barrier	TQQ	●	●				●					
Terminal extensions	TBB	-	-				-					
Installation and Dimensions												
Connection/Installation	Front connection	Terminal screw										
	Rear connection	Horizontal/Vertical										
	Plug-in	Switchboard type (Line & Load, Line only), Distribution board type ²⁾										
	DIN rail installation	Possible for using DIN rail adapter			-			Possible for using DIN rail adapter				
Dimensions (mm)		a (2/3/4P)	75/75/100	75/75/100	90/90/120	75/75/100						
		b	130	130	155	130						
		c	68	68	68	68						
		Weight (kg)	2/3/4P	0.7/0.8/1.0	0.7/0.8/1.0	0.9/1.0/1.3	0.7/0.8/1.0					
Detailed rating and select		122 Page		122 Page				122 Page				
Characteristics curve and outside view		70 - 80 Page		70 - 80 Page				70 - 80 Page				

※ 1) 4 pole arrangement: Basic specification is R-S-T-N (N-R-S-T is optional).

2) Plug-in: Applicable only 3P.

3) 2P product is just removed versus central pole of 3P product. So, 2P product's dimension is equal to 3P product's dimension.



HGM100				HGM125				HGM160				HGM250			
100				125				160				250			
2 ²⁾ , 3, 4 ¹⁾				2 ²⁾ , 3, 4 ¹⁾				2 ²⁾ , 3, 4 ¹⁾				2 ²⁾ , 3, 4 ¹⁾			
16, 20, 25, 32, 40, 50, 63, 75, 80, 100				16, 20, 25, 32, 40, 50, 63, 75, 80, 100, 125				100, 125, 150, 160				100, 125, 150, 160, 175, 200, 225, 250			
E	S	H	L	E	S	H	L	E	S	H	L	E	S	H	L
2.5	5	7.5	8	5	7.5	8	10	7.5	8	8	10	7.5	8	8	10
7.5	10	14	26	10	14	26	35	14	20	26	35	14	20	26	35
16	20	26	30	20	26	38	55	20	26	38	55	20	26	38	55
16	20	26	30	20	26	38	55	20	26	38	55	20	26	38	55
35	50	50	50	50	65	85	100	50	65	85	100	50	65	85	100
100	100	75	50	100	100	100	100	100	100	100	100	100	100	100	100
30,000				30,000				25,000				25,000			
10,000				10,000				10,000				10,000			
200 mA/100 mV				200 mA/100 mV				200 mA/100 mV				200 mA/100 mV			
(1.0) x In				(1.0) x In				(1.0) x In				(1.0) x In			
16 - 32 A: 400 A, 40 - 100 A: 10 x In				16 - 32 A: 400 A, 40 - 125 A: 10 x In				10 x In				10 x In			
●				●				●				●			
●				●				●				●			
●				●				●				●			
●				●				●				●			
●				●				●				●			
●				●				●				●			
●				●				●				●			
●				●				●				●			
●				●				●				●			
●				●				●				●			
● (3P Only)				● (3P Only)				● (3P Only)				● (3P Only)			
● (3P Only)				● (3P Only)				● (3P Only)				● (3P Only)			
● (3P Only)				● (3P Only)				-				-			
● (3P Only)				● (3P Only)				-				-			
● (2, 3P Only)				● (3P Only)				-				-			
●				●				●				●			
●				●				●				●			
●				●				●				●			
-				-				●				●			
Terminal screw				Terminal screw				Terminal screw, Terminal busbar				Terminal screw, Terminal busbar			
Horizontal/Vertical				Horizontal/Vertical				Horizontal/Vertical				Horizontal/Vertical			
Switchboard type (Line & Load, Line only), Distribution board type ²⁾				Switchboard type (Line & Load, Line only), Distribution board type ²⁾				Switchboard type (Line & Load, Line only) ²⁾				Switchboard type (Line & Load, Line only) ²⁾			
Possible for using DIN rail adapter				-				-				-			
75/75/100				90/90/120				105/105/140				105/105/140			
130				155				165				165			
68				68				68				68			
0.7/0.8/1.0				0.9/1.0/1.3				1.1/1.3/1.7				1.1/1.3/1.7			
122 Page				122 Page				122 Page				122 Page			
70 - 80 Page				70 - 80 Page				70 - 80 Page				70 - 80 Page			

Model Selection Table

ZCT MCCB (HGM Type): 400 - 800 AF

Things in Common

Rated Insulation Voltage, U_i	1,000 V
Rated Operational Voltage, U_e	690 V
Impulse Withstand Voltage, U_{imp}	8 kV
Protective Function	Overload, short-circuit and instantaneous protection

Suitability for Isolation	Yes
Utilization Category	A
Polution Degree	3
Reference Standard	IEC 60947-2

Model		HGM400				HGM630				HGM800				
Frame	(AF)	400				630				800				
Pole	(P)	2 ³⁾ , 3, 4 ¹⁾				2 ³⁾ , 3				2 ³⁾ , 3				
Rated current, at 40 °C	(A)	250, 300, 350, 400				500, 630				700, 800				
Rated short-circuit breaking capacity [Icu] (kA rms)	Recognition code for order	E	S	H	L	E	S	H	L	S	H	L		
	AC660/690 V	5	8	10	14	5	8	10	14	8	10	14		
	AC480/500 V	18	35	50	65	25	45	50	65	45	50	65		
	AC440/460 V	38	50	70	85	38	50	70	85	50	70	85		
	AC380/415 V	45	65	85	100	45	65	85	100	65	85	100		
	AC220/240 V	50	75	100	125	50	75	100	125	75	100	125		
Service breaking capacity [Ics = % Icu]		100	100	100	100	100	100	100	100	100	100	100		
Endurance (Durability)	Mechanical	4,000				2,500				2,500				
	Electrical	1,000				500				500				
ZCT Output characteristic		200 mA/100 mV				200 mA/100 mV				200 mA/100 mV				
Trip Device														
Thermal magnetic	Long time [LT]	(1.0) x I _n				(1.0) x I _n				(1.0) x I _n				
	Instantaneous [INST]	10 x I _n				10 x I _n				10 x I _n				
Accessory														
Internal	Auxiliary switch	AUX	●				●				●			
	Alarm switch	ALT	●				●				●			
	Shunt trip	SHT	●				●				●			
	Undervoltage trip	UVT	●				●				●			
External	Rotary handle	Front contact	TFG	●				●				●		
		Extended	TFH	●				●				●		
	Motor operator	MOT	●				●				●			
	Mechanical interlock	MIF	●				●				●			
	Locking device	PLD	●				●				●			
	Plug-in	TDM (LINE/LOAD)	● (3P Only)				● (3P Only)				● (3P Only)			
		TDM (LINE only)	● (3P Only)				● (3P Only)				● (3P Only)			
		TDF (LINE only)	-				-				-			
		TDA (1 row)	-				-				-			
		TDA (2 row)	-				-				-			
	Cage terminal block	CTB	●				●				●			
Insulation terminal cover	TCF	●				●				●				
Insulation barrier	TQQ	●				●				●				
Terminal extensions	TBB	●				●				●				
Installation and Dimensions														
Connection/Installation	Front connection	Terminal screw				Terminal screw, Terminal busbar								
	Rear connection	Horizontal/Vertical wiring				Horizontal/Vertical wiring								
	Plug-in	Switchboard type (Line & Load, Line only) ²⁾				Switchboard type (Line & Load, Line only) ²⁾								
Dimensions (mm)		a (2/3/4P)	140/140/184				210/210				210/210			
		b	257				280				280			
		c	110				110				110			
Weight (kg)	2/3/4P	4/4.5/5.4				8.7/9.5				8.7/9.5				
Detailed rating and select		122 Page				122 Page				122 Page				
Characteristics curve and outside view		70 - 80 Page				70 - 80 Page				70 - 80 Page				

※ 1) 4 pole arrangement: Basic specification is R-S-T-N (N-R-S-T is optional).

2) Plug-in: Applicable only 3P.

3) 2P product is just removed versus central pole of 3P product. So, 2P product's dimension is equal to 3P product's dimension.

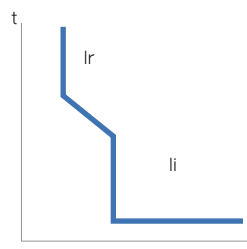

Characteristic Curve
(I - t Curve)

Trip Unit Characteristics - Thermal Magnetic

Rated Current (A) [In]		16	20	25	32	40	50	63	75	80	100	125
MCCB	HGM30	●	●	●	●							
	HGM50	●	●	●	●	●	●					
	HGM60	●	●	●	●	●	●	●				
	HGM100	●	●	●	●	●	●	●	●	●	●	
	HGM125	●	●	●	●	●	●	●	●	●	●	●

Time Pick-Up Characteristics [Ir]

Settings (A)	1.0 x In	16	20	25	32	40	50	63	75	80	100	125
--------------	----------	----	----	----	----	----	----	----	----	----	-----	-----

Instantaneous Pick-Up Characteristics [Ii]

Settings (A)	10 x In	400		400	400	400	500	630	750	800	1,000	1,250
	Instantaneous pick-up characteristics (A)	320		320	320	320	400	504	600	640	800	1,000
	The minimum operating current (A)	480		480	480	480	600	756	900	960	1,200	1,500

Neutral Pole Protection

4P3D	Unprotected
4P4D	-

Rated Current (A) [In]		100	125	150	160	175	200	225	250	300	350	400	500	630	700	800
MCCB	HGM160	●	●	●	●											
	HGM250	●	●	●	●	●	●	●	●							
	HGM400								●	●	●	●				
	HGM630												●	●		
	HGM800														●	●

Time Pick-Up Characteristics [Ir]

Settings (A)	1.0 x In	100	125	150	160	175	200	225	250	300	350	400	500	630	700	800
--------------	----------	-----	-----	-----	-----	-----	-----	-----	-----	-----	-----	-----	-----	-----	-----	-----

Instantaneous Pick-Up Characteristics [Ii]

Settings (A)	10 x In	1,000	1,250	1,500	1,600	1,750	2,000	2,250	2,500	3,000	3,500	4,000	5,000	6,300	7,000	8,000
	Instantaneous pick-up characteristics (A)	800	1,000	1,200	1,280	1,400	1,600	1,800	2,000	2,400	2,800	3,200	4,000	5,040	5,600	6,400
	The minimum operating current (A)	1,200	1,500	1,800	1,920	2,100	2,400	2,700	3,000	3,600	4,200	4,800	6,000	7,560	8,400	9,600

Neutral Pole Protection

4P3D	Unprotected
4P4D	-

Model Selection Table

ELCB (HGE Type): 32 - 250 AF

Things in Common

Rated Operational Voltage, Ue	220/460 V	Suitability for Isolation	Yes
Impulse Withstand Voltage, Uimp	6 kV	Utilization Category	A
Protective Function	Overload, short-circuit and instantaneous protection	Pollution Degree	3
		Reference Standard	IEC 60947-2

Model		HGE30	HGE50	HGE60	
Frame	(AF)	32	50	63	
Pole	(P)	2 ³⁾ , 3, 4 ¹⁾	2 ³⁾ , 3, 4 ¹⁾	2 ³⁾ , 3, 4 ¹⁾	
Rated current, at 40 °C	(A)	16, 20, 25, 32	16, 20, 25, 32, 40, 50	16, 20, 25, 32, 40, 50, 63	
High speed type	Rated residual current (mA)	30	30	30	
	Maximum residual current off-time (s)	0.1	0.1	0.1	
Time delay type	Rated residual current (mA)	100 - 300 - 500 - 1,000 Adjustable	100 - 300 - 500 - 1,000 Adjustable	100 - 300 - 500 - 1,000 Adjustable	
	Maximum residual current off-time (s)	0.1 - 0.4 - 1.0 - 2.0	0.1 - 0.4 - 1.0 - 2.0	0.1 - 0.4 - 1.0 - 2.0	
	Inertial non-operating time (ms)	0 - 200 - 500 - 1,000 Adjustable	0 - 200 - 500 - 1,000 Adjustable	0 - 200 - 500 - 1,000 Adjustable	
Rated short-circuit breaking capacity [Icu] (kA rms)	Recognition code for order	E S	E S H L	E S H L	
	AC440/460 V	16 20	16 20 38 55	16 20 26 30	
	AC380/415 V	16 20	16 20 38 55	16 20 26 30	
	AC220/240 V	35 50	35 50 85 100	35 50 50 50	
Service breaking capacity [Ics = % Icu]	100	100	100 100 100 100	100 100 75 50	
Endurance (Durability)	Inverse time delay [LT]	30,000	30,000	30,000	
	Short time pick-up [LT]	10,000	10,000	10,000	
Trip Device					
Thermal magnetic	Long time [LT]	(1.0) x In	(1.0) x In	(1.0) x In	
	Instantaneous [INST]	400 A	16 - 32 A: 400 A, 40-50 A: 10 x In	16 - 32 A: 400 A, 40 - 63 A: 10 x In	
Accessory					
Internal	Auxiliary switch AUX	●	●	●	
	Alarm switch ALT	●	●	●	
	Shunt trip SHT	-	-	-	
	Undervoltage trip UVT	-	-	-	
External	Rotary handle	Front contact TFG	●	●	●
		Extended TFH	●	●	●
	Motor operator MOT	●	●	●	
	Mechanical interlock MIF	●	●	●	
	Locking device PLD	●	●	●	
	Plug-in	TDM (LINE/LOAD)	● (3P Only)	● (3P Only) ● (3P Only)	● (3P Only)
		TDM (LINE only)	● (3P Only)	● (3P Only) ● (3P Only)	● (3P Only)
		TDF (LINE only)	● (3P Only)	● (3P Only) ● (3P Only)	● (3P Only)
		TDA (1 row)	● (3P Only)	● (3P Only) ● (3P Only)	● (3P Only)
		TDA (2 row)	● (2, 3P Only)	● (2, 3P Only) ● (3P Only)	● (2, 3P Only)
	Cage terminal block CTB	●	●	●	
	Insulation terminal cover TCF	●	●	●	
	Insulation barrier TQQ	●	●	●	
Terminal extensions TBB	-	-	-		

Installation And Dimensions

Connection/Installation	Front connection	Terminal screw			
	Rear connection	Horizontal/Vertical			
	Plug-in	Switchboard type (Line & Load, Line only), Distribution board type ²⁾			
	DIN rail Installation	Possible for using DIN rail adapter	-	Possible for using DIN rail adapter	
Dimensions (mm)	a (2/3/4P)	75/75/100	75/75/100	90/90/120	75/75/100
	b	130	130	155	130
	c	68	68	68	68
Weight (kg)	2/3/4P	0.8/0.9/1.3	0.8/0.9/1.3	1.0/1.1/1.4	0.8/0.9/1.3
Detailed rating and select		122 Page	122 Page		122 Page
Characteristics curve and outside view		70 - 85 Page	70 - 85 Page		70 - 85 Page

※ 1) 4 pole arrangement: Basic specification is R-S-T-N (N-R-S-T is optional).

2) Plug-in: Applicable only 3P.

3) 2P product is just removed versus central pole of 3P product. So, 2P product's dimension is equal to 3P product's dimension.



HGE100				HGE125				HGE160				HGE250			
100				125				160				250			
2 ²⁾ , 3, 4 ¹⁾				2 ²⁾ , 3, 4 ¹⁾				2 ²⁾ , 3, 4 ¹⁾				2 ²⁾ , 3, 4 ¹⁾			
16, 20, 25, 32, 40, 50, 63, 75, 80, 100				16, 20, 25, 32, 40, 50, 63, 75, 80, 100, 125				100, 125, 150, 160				100, 125, 150, 160, 175, 200, 225, 250			
30				30				30				30			
0.1				0.1				0.1				0.1			
100 - 300 - 500 - 1,000 Adjustable				100 - 300 - 500 - 1,000 Adjustable				100 - 300 - 500 - 1,000 Adjustable				100 - 300 - 500 - 1,000 Adjustable			
0.1 - 0.4 - 1.0 - 2.0				0.1 - 0.4 - 1.0 - 2.0				0.1 - 0.4 - 1.0 - 2.0				0.1 - 0.4 - 1.0 - 2.0			
0 - 200 - 500 - 1,000 Adjustable				0 - 200 - 500 - 1,000 Adjustable				0 - 200 - 500 - 1,000 Adjustable				0 - 200 - 500 - 1,000 Adjustable			
E	S	H	L	E	S	H	L	E	S	H	L	E	S	H	L
16	20	26	30	20	26	38	55	20	26	38	55	20	26	38	55
16	20	26	30	20	26	38	55	20	26	38	55	20	26	38	55
30	50	50	50	50	65	85	100	50	65	85	100	50	65	85	100
100	100	75	50	100	100	100	100	100	100	100	100	100	100	100	100
30,000				30,000				25,000				25,000			
10,000				10,000				10,000				10,000			
(1.0) x In				(1.0) x In				(1.0) x In				(1.0) x In			
16 - 32 A: 400 A, 40 - 100 A: 10 x In				16 - 32 A: 400 A, 40 - 125 A: 10 x In				10 x In				10 x In			
●				●				●				●			
●				●				●				●			
-				-				-				-			
●				●				●				●			
●				●				●				●			
●				●				●				●			
●				●				●				●			
● (3P Only)				● (3P Only)				● (3P Only)				● (3P Only)			
● (3P Only)				● (3P Only)				● (3P Only)				● (3P Only)			
● (3P Only)				● (3P Only)				-				-			
● (3P Only)				● (3P Only)				-				-			
● (2, 3P Only)				● (3P Only)				-				-			
●				●				●				●			
●				●				●				●			
●				●				●				●			
-				-				●				●			
Terminal screw								Terminal screw							
Horizontal/Vertical								Horizontal/Vertical							
Switchboard type (Line & Load, Line only), Distribution board type ²⁾								Switchboard type (Line & Load, Line only) ²⁾							
Possible for using DIN rail adapter								-							
75/75/100				90/90/120				105/105/140				105/105/140			
130				155				165				165			
68				68				68				68			
0.8/0.9/1.3				1.0/1.1/1.4				1.3/1.5/1.9				1.3/1.5/1.9			
122 Page				122 Page				122 Page				122 Page			
70 - 85 Page				70 - 85 Page				70 - 85 Page				70 - 85 Page			

Model Selection Table

ELCB (HGE Type): 400 - 800 AF

Things in Common

Rated Operational Voltage, Ue	220/460 V
Impulse Withstand Voltage, Uimp	6 kV
Protective Function	Overload, short-circuit and instantaneous protection

Suitability for Isolation	Yes
Utilization Category	A
Pollution Degree	3
Reference Standard	IEC 60947-2

Model	HGE400				HGE630				HGE800				
Frame (AF)	400				630				800				
Pole (P)	2 ³⁾ , 3, 4 ¹⁾				2 ³⁾ , 3				2 ³⁾ , 3				
Rated current, at 40 °C (A)	250, 300, 350, 400				500, 630				700, 800				
High speed type	Rated residual current (mA)	30				30				30			
	Maximum residual current off-time (s)	0.1				0.1				0.1			
Time delay type	Rated residual current (mA)	100 - 300 - 500 - 1,000 Adjustable				100 - 300 - 500 - 1,000 Adjustable				100 - 300 - 500 - 1,000 Adjustable			
	Maximum residual current off-time (s)	0.1 - 0.4 - 1.0 - 2.0				0.1 - 0.4 - 1.0 - 2.0				0.1 - 0.4 - 1.0 - 2.0			
	Inertial non-operating time (ms)	0 - 200 - 500 - 1,000 Adjustable				0 - 200 - 500 - 1,000 Adjustable				0 - 200 - 500 - 1,000 Adjustable			
Rated short-circuit breaking capacity [Icu] (kA rms)	Recognition code for order	E	S	H	L	E	S	H	L	S	H	L	
	AC440/460 V	38	50	70	85	38	50	70	85	50	70	85	
	AC380/415 V	45	65	85	100	45	65	85	100	65	85	100	
	AC220/240 V	50	75	100	125	50	75	100	125	75	100	125	
Service breaking capacity [Ics = % Icu]	100	100	100	100	100	100	100	100	100	100	100	100	
Endurance (Durability)	Inverse time delay [LT]	4,000				2,500				2,500			
	Short time pick-up [LT]	1,000				500				500			
Trip Device													
Thermal magnetic	Long time [LT]	(1.0) x In				(1.0) x In				(1.0) x In			
	Instantaneous [INST]	10 x In				10 x In				10 x In			
Accessory													
Internal	Auxiliary switch AUX	●				●				●			
	Alarm switch ALT	●				●				●			
	Shunt trip SHT	●				●				●			
	Undervoltage trip UVT	●				●				●			
External	Rotary handle	Front contact TFG	●				●				●		
		Extended TFH	●				●				●		
	Motor operator MOT	●				●				●			
	Mechanical interlock MIF	●				●				●			
	Locking device PLD	●				●				●			
	Plug-in	TDM (LINE/LOAD)	● (3P Only)				● (3P Only)				● (3P Only)		
		TDM (LINE only)	● (3P Only)				● (3P Only)				● (3P Only)		
		TDF (LINE only)	-				-				-		
		TDA (1 row)	-				-				-		
		TDA (2 row)	-				-				-		
	Cage terminal block CTB	●				●				●			
	Insulation terminal cover TCF	●				●				●			
Insulation barrier TQQ	●				●				●				
Terminal extensions TBB	●				●				●				
Installation and Dimensions													
Connection/Installation	Front connection	Terminal screw				Terminal screw, Terminal busbar							
	Rear connection	Horizontal/Vertical/Front wiring				Horizontal/Vertical/Front wiring							
	Plug-in	Switchboard type (Line & Load, Line only) ²⁾				Switchboard type (Line & Load, Line only) ²⁾							
Dimensions (mm)	a (2/3/4P)	140/140/184				210/210				210/210			
	b	257				280				280			
	c	110				110				110			
	Weight (kg)	3/4P	4/4.5/5.4				8.7/9.5				8.7/9.5		
Detailed rating and select	122 Page				122 Page				122 Page				
Characteristics curve and outside view	70 - 85 Page				70 - 85 Page				70 - 85 Page				

※ 1) 4 pole arrangement: Basic specification is R-S-T-N (N-R-S-T is optional).

2) Plug-in: Applicable only 3P.

3) 2P product is just removed versus central pole of 3P product. So, 2P product's dimension is equal to 3P product's dimension.

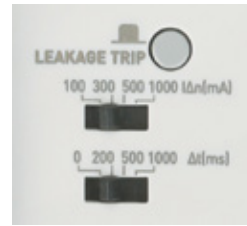
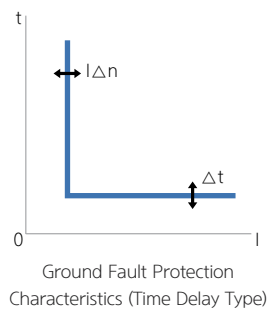
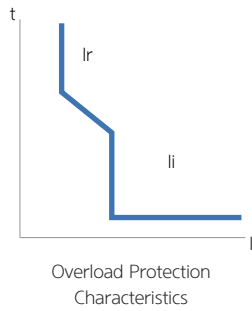

Trip Unit Characteristics - Thermal Magnetic

Rated Current (A) [In]		16	20	25	32	40	50	63	75	80	100	125
ELCB	HGE30	●	●	●	●							
	HGE50	●	●	●	●	●	●					
	HGE60	●	●	●	●	●	●	●				
	HGE100	●	●	●	●	●	●	●	●	●	●	
	HGE125	●	●	●	●	●	●	●	●	●	●	●

Time Pick-Up Characteristics [Ir]		16	20	25	32	40	50	63	75	80	100	125
Settings (A)	1.0 x In											

Instantaneous Pick-Up Characteristics [Ii]		16	20	25	32	40	50	63	75	80	100	125
Settings (A)	10 x In	400		400	400	400	500	630	750	800	1,000	1,250
	I _{Max.} non-operating current (A)	320		320	320	320	400	504	600	640	800	1,000
	Min. operating current (A)	480		480	480	480	600	756	900	960	1,200	1,500

Rated Residual Current, I_{Δn}

High speed type	Fixed: 30 mA
Time delay type	Adjustable: 100 - 300 - 500 - 1,000 mA

Inertial Non-Operating, Δt

High speed type	Fixed: 0 ms
Time delay type	Adjustable: 0 - 200 - 500 - 1,000 ms

Neutral Pole Protection

4P3D	Unprotected
4P4D	-

Rated Current (A) [In]		100	125	150	160	175	200	225	250	300	350	400	500	630	700	800
ELCB	HGE160	●	●	●	●											
	HGE250	●	●	●	●	●	●	●								
	HGE400								●	●	●	●				
	HGE630												●	●		
	HGE800														●	●

Time Pick-Up Characteristics [Ir]		100	125	150	160	175	200	225	250	300	350	400	500	630	700	800
Settings (A)	1.0 x In															

Instantaneous Pick-Up Characteristics [Ii]		100	125	150	160	175	200	225	250	300	350	400	500	630	700	800
Settings (A)	10 x In	1,000	1,250	1,500	1,600	1,750	2,000	2,250	2,500	3,000	3,500	4,000	5,000	6,300	7,000	8,000
	I _{Max.} non-operating current (A)	800	1,000	1,200	1,280	1,400	1,600	1,800	2,000	2,400	2,800	3,200	4,000	5,040	5,600	6,400
	Min. operating current (A)	1,200	1,500	1,800	1,920	2,100	2,400	2,700	3,000	3,600	4,200	4,800	6,000	7,560	8,400	9,600

Rated Residual Current, I_{Δn}

High speed type	Fixed: 30 mA
Time delay type	Adjustable: 100 - 300 - 500 - 1,000 mA

Inertial Non-Operating, Δt

High speed type	Fixed: 0 ms
Time delay type	Adjustable: 0 - 200 - 500 - 1,000 ms

Neutral Pole Protection

4P3D	Unprotected
4P4D	-

Accessories

Accessories 34

Internal Accessories

Accessory Type and Install Position	36
Auxiliary Switch (AUX) / Alarm Switch (ALT)	38
Shunt Trip (SHT)	39
Undervoltage Trip (UVT)	40

External Accessories

Locking Device	41
Terminal Cover	42
Insulation Barrier	43
Rotary Handle	44
Front Connection of Fixed Devices	46
Plug-in Connection Devices	48
HG-MCCB Plug-in CBM Wiring Position (TDM Front side)	49
Rear Connection Terminal	51
DIN Rail Adaptor	51
Motor Operator	52

Accessories

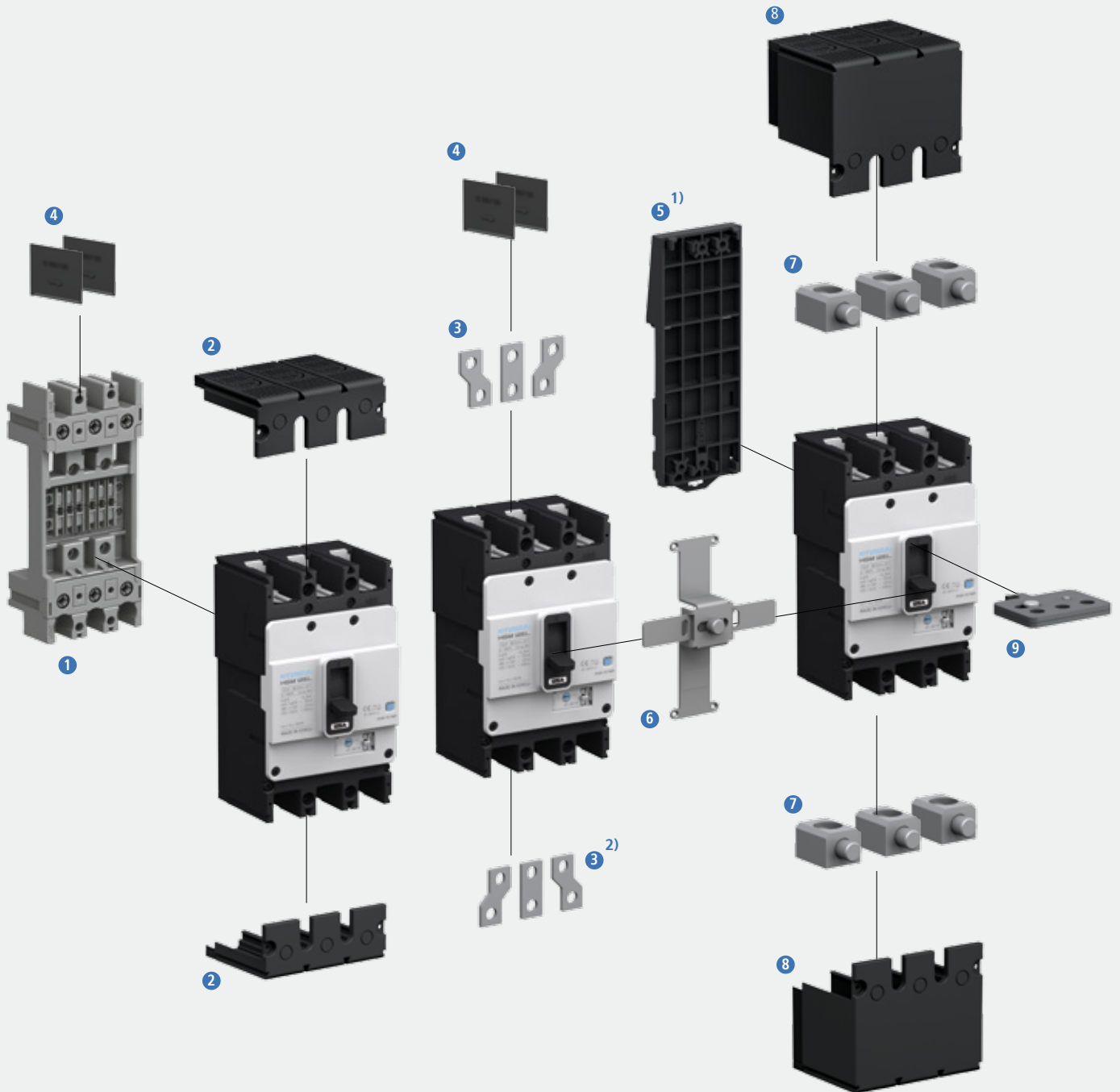

※ **1**) DIN rail adaptor (DRA): HGM/HGE100 only
2) Busbar (TBB): HGM/HGE250 only

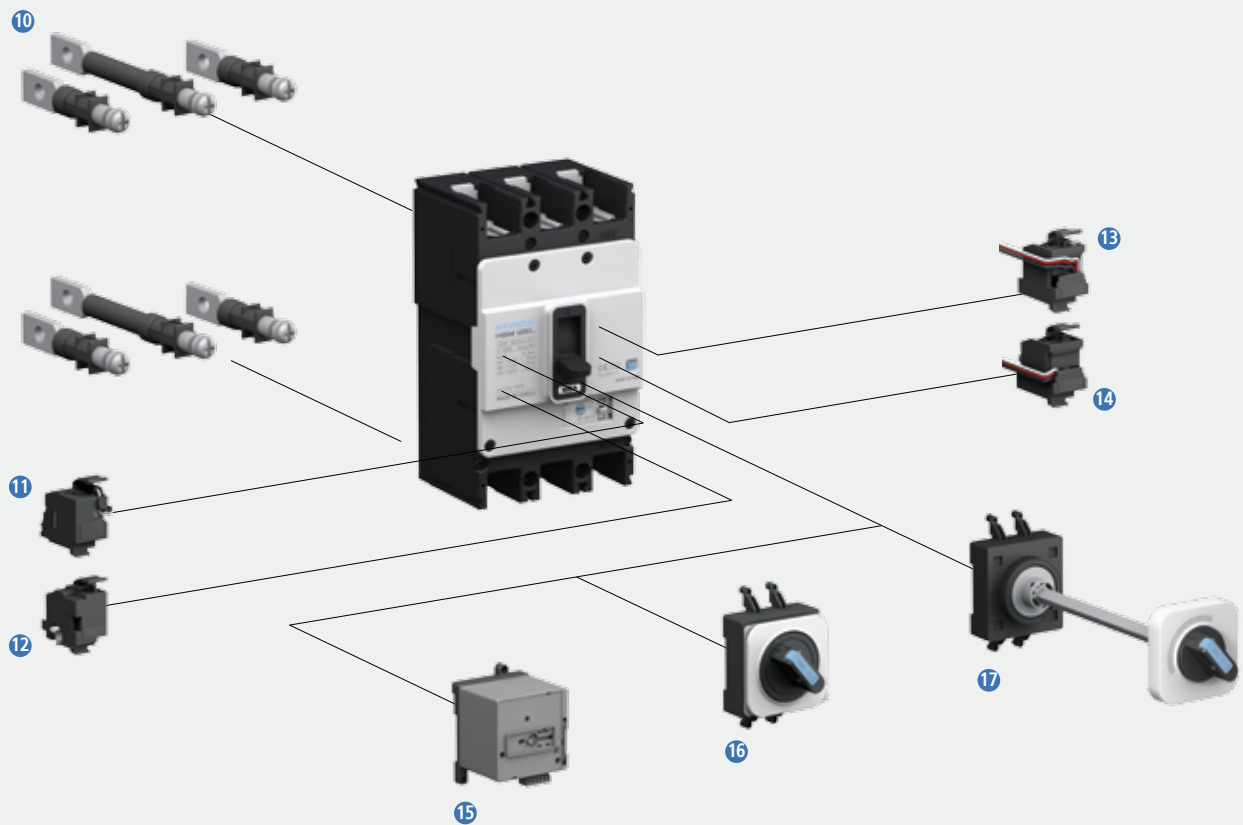

HGM Type Molded Case Circuit Breakers

- | | | |
|-----------------------------------|-----------------------------|---------------------------|
| 1 Plug in Devices | 7 Lug Terminal | 13 Auxiliary Switch |
| 2 Terminal Cover for Plug-In Type | 8 Terminal Cover | 14 Trip Alarm Switch |
| 3 Busbar | 9 Padlock for Rotary Handle | 15 Motor Operator |
| 4 Insulation Barrier | 10 Rear Connection Terminal | 16 Direct Rotary Handle |
| 5 DIN Rail Adaptor | 11 Shunt Trip Coil | 17 Extended Rotary Handle |
| 6 Mechanical Interlock | 12 Undervoltage Trip Coil | |

Internal Accessories

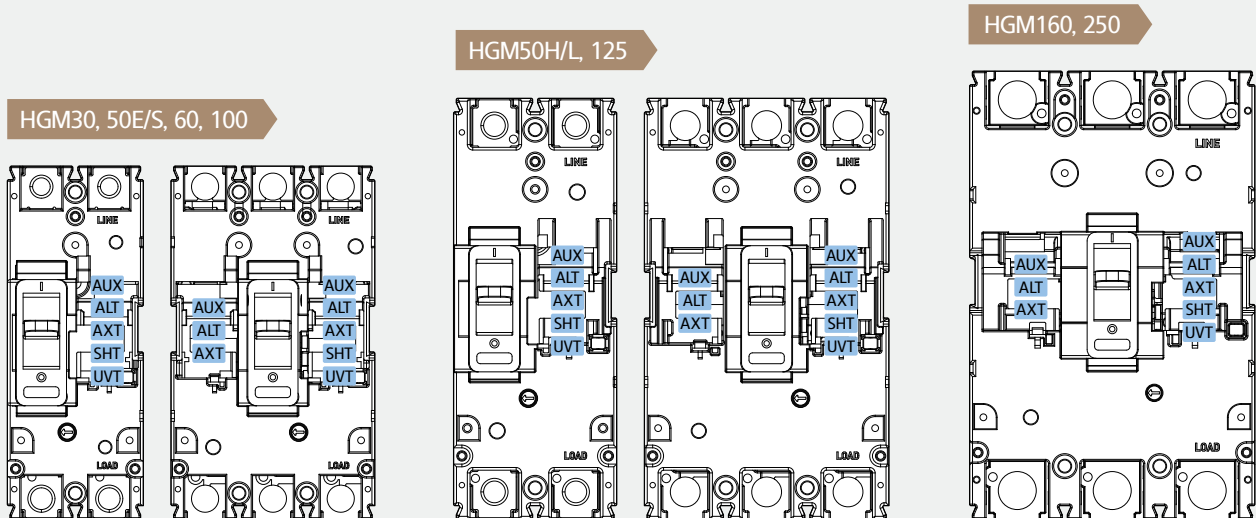
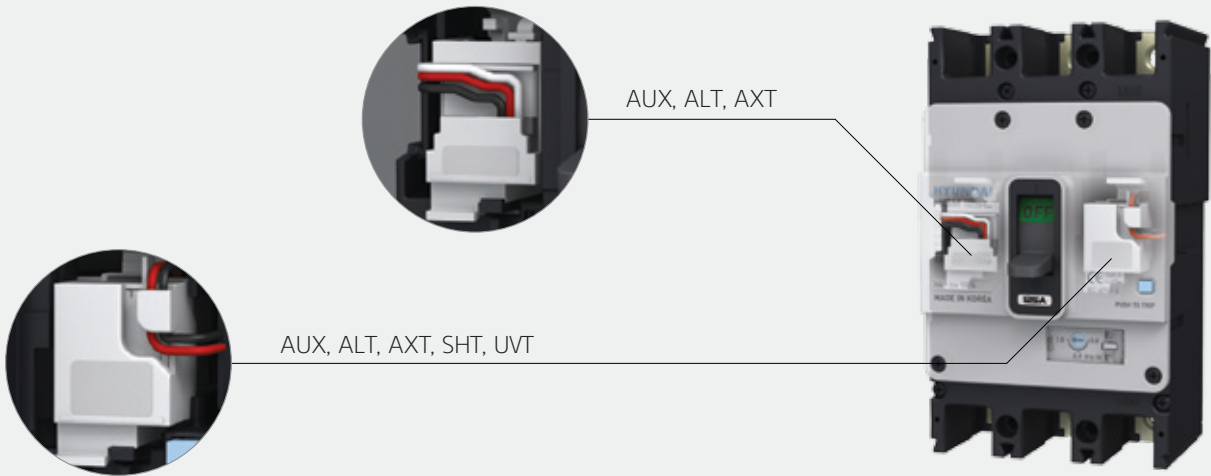

Combinations of Internal Accessories (250 AF or less)

Type	Pole	AUX	ALT	SHT	UVT	AXT	AUX	AUX	SHT	UVT	SHT	UVT	SHT	UVT
							ALT	ALT	AUX	AUX	ALT	ALT	AXT	AXT
HGM30 - HGM125	2													
HGM30 - HGM250	3/4													
HGE30 - HGE250	2/3/4													

※ AUX: Auxiliary switch □ / ALT: Alarm switch ■ / SHT: Shunt trip ☒ / UVT: Under-voltage trip ☒ / AXT: Auxiliary alarm switch □■

Installation of Internal Accessories

- Auxiliary switch (AUX)
- Alarm switch (ALT)
- Auxiliary + Alarm switch (AXT)
- Shunt trip (SHT)
- Undervoltage trip (UVT)

HGM400

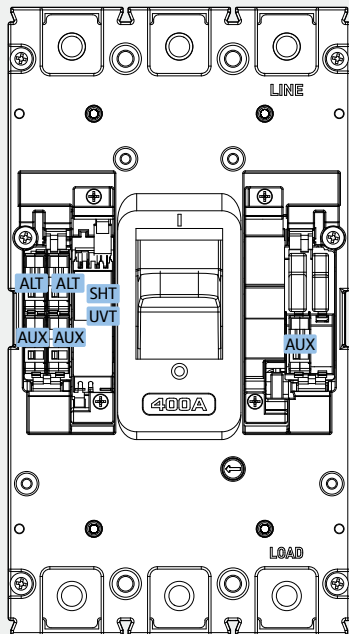

HGM630, 800

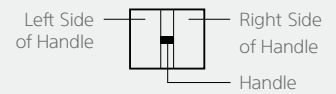
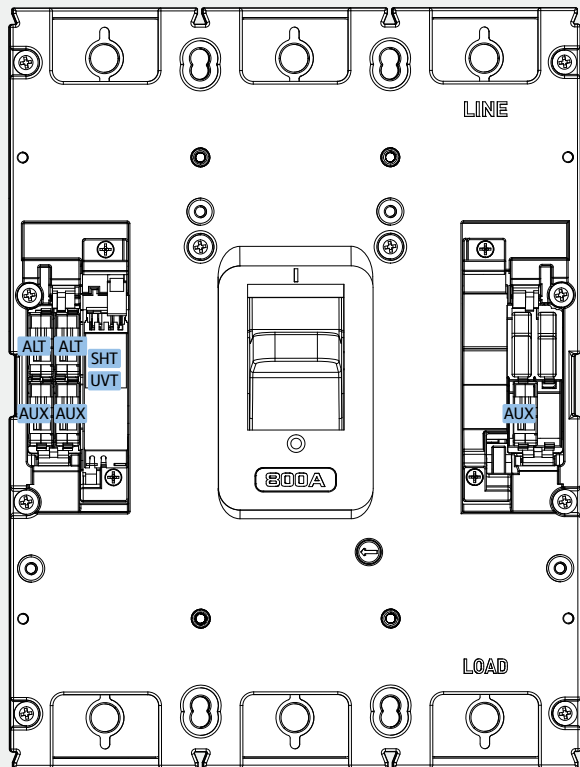

Combinations of Internal Accessories (400 - 800 AF)

Type	Pole	AUX	ALT	SHT	UVT	AUX	SHT	UVT	SHT	UVT	SHT	UVT
						ALT	AUX	AUX	ALT	ALT	AUX	AUX
						ALT	ALT	ALT	ALT	ALT	ALT	ALT
HGM400	2/3/4											
HGM630 HGM800	2/3 4RSTN											
HGM630 HGM800	4NRST											
HGE400	2/3/4											
HGE630 HGE800	2/3											

※ AUX: Auxiliary switch □ / ALT: Alarm switch ■ / SHT: Shunt trip ☒ / UVT: Under-voltage trip ☒
 ※ ZCT MCCB of HGM type is same combinations with HGE type.

Internal Accessories

Auxiliary Switch (AUX), Alarm Switch (ALT)

Indicates the status of circuit breaker contacts from a remote position as well as using for electric locking.

Auxiliary Switch (AUX)

- Indicating ON/OFF status of circuit breaker.
- Status is OFF when TRIP.
- Consists of C contact.



Alarm Switch (ALT)

- Activated when the circuit breaker has tripped due to an overload, short circuit or ground fault excepting manual ON/OFF operation.
- Return to original state, when circuit breaker reset.
- Consist of C contact.



Auxiliary + Alarm Switch (AXT)

- Combined AUX and ALT auxiliary switch.

Contact Circuit Diagram

	Auxiliary Switch (AUX)	Alarm Switch (ALT)
MCCB ON		
MCCB OFF		
MCCB TRIP		

Possible Location for Installation

Type	극수	AUX	ALT	AXT
HGM30 ~ HGM125	2			
HGM30 ~ HGM250	3/4			
HGE30 ~ HGE250	2/3/4			
HGM400	2/3/4			
HGE400	2/3/4			
HGM630 ~ HGM800	2/3/4			
HGE630 ~ HGE800	2/3			

※ AUX: Auxiliary switch □
 ALT: Alarm switch ■
 AXT: Auxiliary alarm switch □■

Rating of Contact

Rated Conventional Thermal Current	5 A		
Minimum Load	160 mA, 5 VDC		
Rated Operational Current	Resistive load	Inductive load	
	AC125 V	5 A	3 A
	AC250 V	3 A	2 A
	DC30 V	4 A	3 A
	DC125 V	0.4 A	0.4 A
DC250 V	0.2 A	0.2 A	

Shunt Trip (SHT)

Remotely trip circuit breakers by voltage shunt trip (SHT) device.

Operation Condition

- $U \geq 0.7 \times U_n$ (Apply more than 70 % of the rated voltage.)
- In case of impulse type voltage, apply more than 20 ms



SHT

Rated Voltage and Characteristics (100 - 250 AF)

Rated Voltage (Un)		Power consumption	
		VA (W)	A (A)
DC	24 V	50.2	2.1
	48 V	94.6	1.97
	60 V	91.2	1.52
	100 - 120 V	11.8	0.1
	125 V	58.1	0.47
AC (50/60 Hz)	100 - 120 V	75.2	0.63
	200 - 250 V	64.8	0.26
	380 - 480 V	131	0.27
Rated Operational Voltage		0.7 - 1.1 x Un	
Operating Time		50 ms	



Possible Location for Installation

Type	Pole	SHT	UVT
HGM30 - HGM125	2		
HGM30 - HGM250	3/4		
HGE30 - HGE250	2/3/4		
HGM400	2/3/4		
HGE400	2/3/4		
HGM630 HGM800	2/3/4		
HGE630 HGE800	2/3		

- ※ SHT: Shunt trip
 UVT: Under-voltage trip

Internal Accessories

Undervoltage Trip (UVT)

In case circuit voltage is less than the reference value, the circuit breaker will not trip or close (ON). If circuit voltage falls less than 35 % of Rated voltage (U_n), UVT initiates a trip automatically to prevent damage to the load.

Opening Conditions

- Operating characteristics is guaranteed based on IEC 60947-2 standard criteria.
- Trip condition: $U \leq 0.35 \times U_n$
- Fixed: 50 ms (400 – 800 AF)
- Time Delay: 500 – 1,000 ms (Up to 250 AF)
- No Trip condition: $U \geq 0.7 \times U_n$
- In $U = 0.35 - 0.7 \times U_n$ interval, circuit breaker can be tripped but, does not warrant the operation.

Closing Conditions

- For the circuit breakers installed with UVT when voltage is not applied to the UVT, the circuit breakers is possible OFF/RESET but can not be ON (Closing).
- Voltage must be applied at UVT for closing (ON).
- Closing condition: $U \geq 0.85 \times U_n$

Time Delay Function

To prevent a malfunction in the short time voltage drop of less than 500 ms. (Up to 250 AF)

Rated Voltage and Characteristic (Up to 250 AF)

Rated Voltage (U_n)		Power consumption	
		VA (W)	A (mA)
DC	24 V	0.96	40
	48 V	1.1	22.7
	100 – 110 V	2.2	20
AC (50/60 Hz)	100 – 120 V	5.1	42
	200 – 230 V	6	26
	380 – 415 V	9.6	23
	440 – 480 V	12.5	26
Operating Inception Voltage	In the Case of Trip	0.35 – 0.7 x U_n	
	In the Case of Closing	0.85 x U_n	
Rated Operational Voltage		0.85 – 1.1 x U_n	
Operating Time		500 – 1,000 ms	

※ Be sure not to use UVT for the electrical interlock system.



UVT



UVT Controller

External Accessories

Locking Device

Padlock Device for Handle (PLD)

This device is used for locking the handle of circuit breakers to OFF position by using padlock. Key lock is applicable upto 3 EA and not be supplied additionally. Ratings of keylock are as below.



Type	Application	Padlock Diameter
PLD 10GM	HGM30 - HGM250	5 mm
	HGE30 - HGE250	
PLD 40GM	HGM400 - HGM800	6 mm
	HGE400 - HGE800	

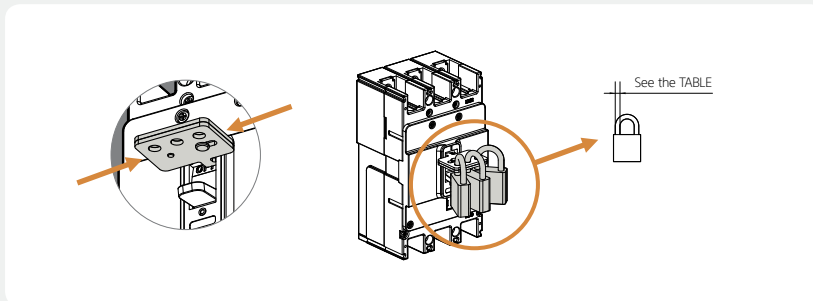

Mechanical Interlock

This device interlocks two circuit breakers mechanically.

Features

- It prevents two breakers from closing at the same time.
- It turns two breakers all OFF.

Ratings of keylock are as below.



Type				Application	Padlock Diameter
2P	3P	4P (RSTN)	4P (NRST)		
MIF 10GM 2	MIF 10GM 3	MIF 10GM R4	MIF 10GM N4	HGM/HGE30, 50E/S, 60, 100	5 mm
MIF 12GM 2	MIF 12GM 3	MIF 12GM R4	MIF 12GM N4	HGM/HGE50H/L, 125	
-	MIF 25GM 3	MIF 25GM R4	MIF 25GM N4	HGM/HGE160, 250	6 mm
-	MIF 40GM 3	MIF 40GM R4	MIF 40GM N4	HGM/HGE400	
-	MIF 80GM 3	MIF 80GM R4	MIF 80GM N4	HGM/HGE630, 800	

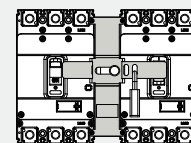
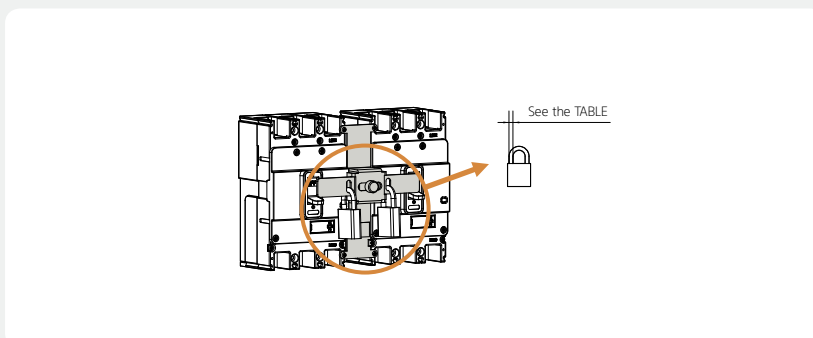

Right Off Lock

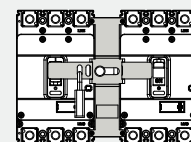

Left Off Lock

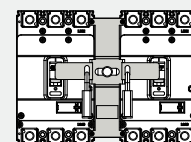

Double Off Lock

External Accessories

Terminal Cover

Terminal cover is the device to insulate circuit breaker terminal from the outside for safety. It is possible to apply IP40 as protection degree of power parts. Based on the connecting methods of the circuit breakers long or short type terminals can be applied.

Short Type

Suitable for plug-in or rear connection.



Long Type

Suitable for front connection using wires, busbar, or lug terminals.



Type						Application	Pitch (mm)
2P		3P		4P			
Short	Long	Short	Long	Short	Long		
TCF 10GM S2	TCF 10GM L2	TCF 10GM S3	TCF 10GM L3	TCF 10GM S4	TCF 10GM L4	HGM30, 50E/S, 60, 100 HGE30, 50E/S, 60, 100	25
TCF 12GM S2	TCF 12GM L2	TCF 12GM S3	TCF 12GM L3	TCF 12GM S4	TCF 12GM L4	HGM50H/L, 125 HGE50H/L, 125	30
TCF 25GM S3	TCF 25GM L3	TCF 25GM S3	TCF 25GM L3	TCF 25GM S4	TCF 25GM L4	HGM160, 250 HGE160, 250	35
TCF 40GM S3	TCF 40GM L3	TCF 40GM S3	TCF 40GM L3	TCF 40GM S4	TCF 40GM L4	HGM400 HGE400	44
TCF 80GM S3	TCF 80GM L3	TCF 80GM S3	TCF 80GM L3	TCF 80GM S4	TCF 80GM L4	HGM630, 800 HGE630, 800	70

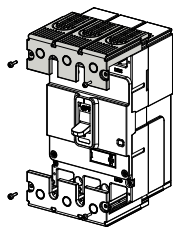

Drawings

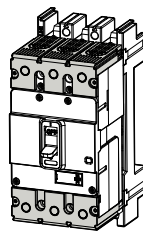

Short Type
(Plug-In Connection)

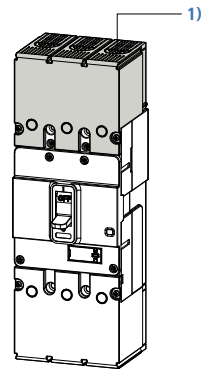

Long Type
(Front Connection)

※ 1) For front connection, please use it after removing the mark 1)

Insulation Barrier

Insulation barrier is used for preventing short-circuit fault due to dielectric breakdown between circuit breaker terminals. It improves the performance of terminal phase-to-phase insulation if installed at groove between the terminal of two circuit breakers. It can be easily assembled after the installation of the circuit breaker. In addition, it is used in terminal cover and plug-in base.



Type			Application	Number of Parts (EA/Set)		
2P	3P	4P		2P	3P	4P
TQQ 10GM 2	TQQ 10GM 3	TQQ 10GM 4	HGM30, 50E/S, 60, 100 HGE30, 50E/S, 60, 100	1	2	3
TQQ 10GM 2	TQQ 10GM 3	TQQ 10GM 4	HGM50H/L, 125 HGE50H/L, 125	1	2	3
TQQ 25GM 2	TQQ 25GM 3	TQQ 25GM 4	HGM160, 250 HGE160, 250	1	2	3
TQQ 63GP 2	TQQ 63GP 3	TQQ 63GP 4	HGM400 HGE400	1	2	3
TQQ 63GP 2	TQQ 63GP 3	TQQ 63GP 4	HGM630, 800 HGE630, 800	1	2	3

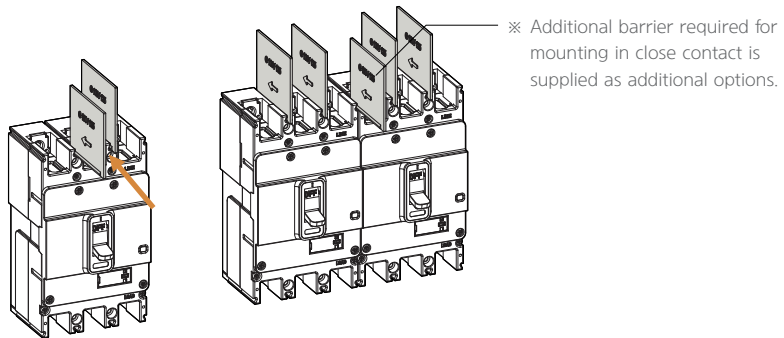

External Accessories

Rotary Handle

Rotary handle is the device to check for MCCB's ON/OFF/TRIP status from outside of switchgear. There are two types of rotary handle-extended type and direct type. All the rotary handles provide panel door locking and handle locking function by rotating clockwise the rotary handle, the circuit breaker operates "ON". Each rotary handle is divided into these three types the upper line, the right line, and the left line-according to attachment direction of MCCB. The IP rating of the handle is IP40.

Direct Rotary Handle (TFG Type)

- 32 - 250 AF: Attach handle directly to the circuit breaker.
- 400 - 800 AF: Attach handle to the door of switchgear.

Type			Application
Upper Line	Right Line	Left Line	
TFG 10GM U	TFG 10GM R	TFG 10GM L	HGM/HGE30, 50E/S, 60, 100
TFG 12GM U	TFG 12GM R	TFG 12GM L	HGM/HGE50H/L, 125
TFG 25GM U	TFG 25GM R	TFG 25GM L	HGM/HGE160, 250
TFG 40GM U	TFG 40GM R	TFG 40GM L	HGM/HGE400
TFG 80GM U	TFG 80GM R	TFG 80GM L	HGM/HGE630, 800



Direct Rotary Handle

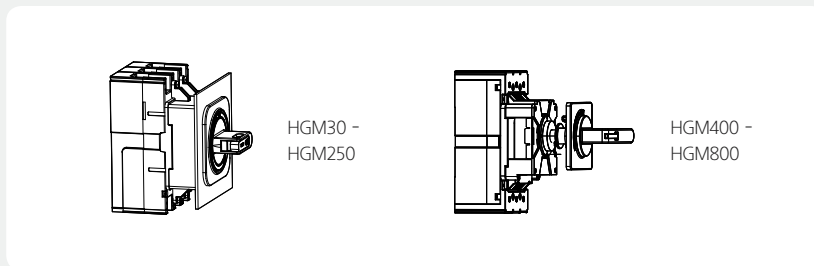

Extended Rotary Handle (TFH Type)

Suitable for the case that long the distance between circuit breaker and door switchgear is long. The handle is attached to the door of switchgear so there is no trip-button function.

Type	Application
TFH 10GM	HGM/HGE30, 50E/S, 60, 100
TFH 12GM	HGM/HGE50H/L, 125
TFH 25GM	HGM/HGE160, 250
TFH 40GM	HGM/HGE400
TFH 80GM	HGM/HGE630, 800

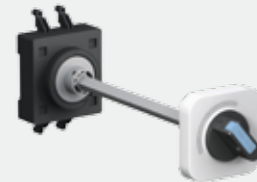

Extended Rotary Handle

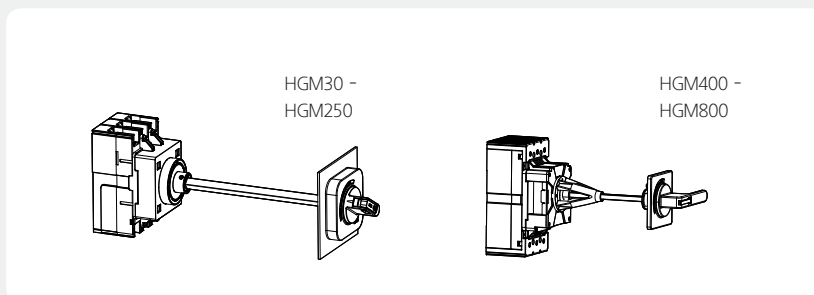

Category of Handle in Accordance with Circuit-Breaker's Installation Type

Rotary handle is divided into the following three types according to the direction of power supply.

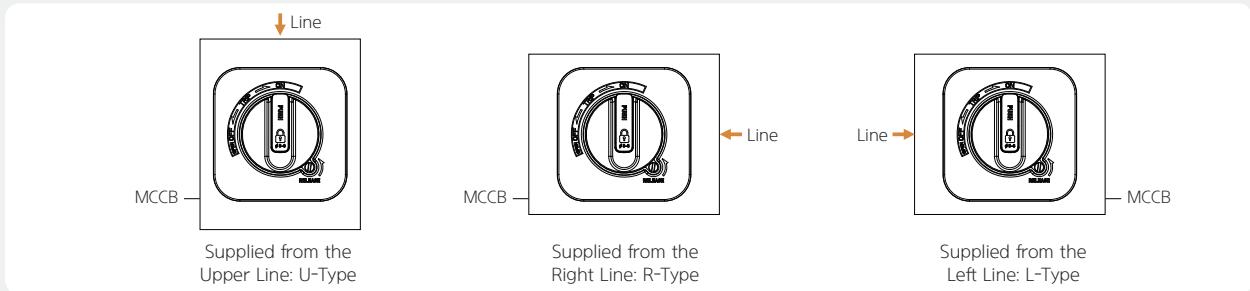

How to Operate Handle

Operating direction: To turn 'ON' the circuit breaker function, rotate handle clockwise.

- Circuit breaker ON: Rotating the handle to ON position. (Figure 1)
- Circuit breaker OFF: Rotating the handle to OFF position. (Figure 2)
- Circuit breaker TRIP: If the circuit breaker is tripped, the handle will be switched to automatically TRIP position. (Figure 3)
- If you rotate the handle to RESET position first after the circuit breaker is tripped (Figure 4) and then rotate the handle to ON position, the circuit breaker is operated ON (Figure 1).
- If you need to open door when handle is in the ON state, rotate the RELEASE screw to direction of the arrow first and then open the door (Figure 5).

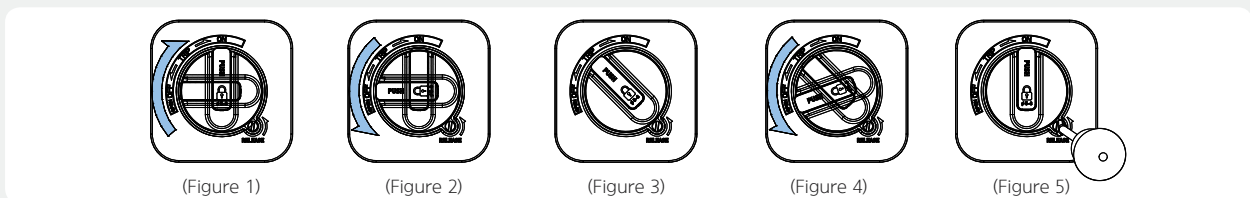
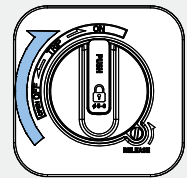

Locking Device

Locking Function	OFF State Door Lock	ON State Door Lock	Reverse Interlock	Handle Padlock ¹⁾
Contents	<ul style="list-style-type: none"> • Impossible to open the switchgear door when the circuit breaker is in the OFF state. • Possible at RESET position • It is possible to open the switchgear door after rotating the handle to RESET. 	<ul style="list-style-type: none"> • Impossible to open the switchgear door when the circuit breaker is in the ON state. • It is possible to open the switchgear door after rotating the RELEASE screw. 	<ul style="list-style-type: none"> • Impossible to put the circuit breaker in the state "ON" when the switchgear door is open. 	<ul style="list-style-type: none"> • Padlocking function for prevention of handle operation. • Padlock is not supplied separately. And the number of usable padlock is decided in accordance with padlock diameter. (Refer to the following table) • The specifications of the applicable padlock are referred to as the following table.
Direct type (TFG)	•	•	• (100/125/250 AF)	•
Extended type (TFH)	•	•	-	•

※ ¹⁾ For TFG 250AF or less, The handle remains ON when the circuit breaker is tripped after padlocking in on position

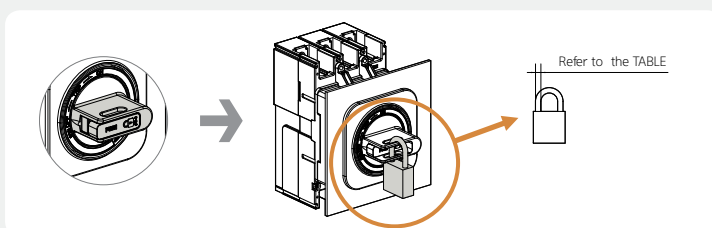

Application	Padlock Diameter	Padlock Quantity
HGM/HGE30 - 250	6 - 8 mm	Ø6, Ø7: 2 EA Ø8: 1 EA
HGM/HGE400 - 800	5 - 7 mm	3 EA

External Accessories

Front Connection of Fixed Devices

Select and use the busbar or LUG terminal according to specification of busbar and cable connected to circuit breaker.

Insulated Bar Connection

If busbar pitch of switchgear is equal to circuit breaker, it is possible to connect the circuit breaker directly using a insulation tube. When connected to the busbar, refer to the specification chart as below. Use the insulation barrier and terminal cover where applicable.

Application	Connection Busbar Dimensions (mm)				Applicable Bolt and Tightening Torque	
	A	B	C	D	Bolt Spec.	Maximum Tightening Torque (kgf x cm)
HGM/HGE 30, 50E/S, 60, 100	< 7.5	< 17	$\varnothing \geq 5.5$ (≤ 50 A)	A + 7.5	M5 Screw (≤ 50 A)	28.5
	< 7.5	< 17	$\varnothing \geq 9$ (> 50 A)	A + 7.5	M8 Screw (> 50 A)	110
HGM/HGE 50H/L, 125	< 7.5	< 20	$\varnothing \geq 9$	A + 7.5	M8 Screw	110
HGM/HGE 160, 250	< 10	< 27	$\varnothing \geq 9$	A + 10	M8 Hex Socket	110
HGM/HGE 400	< 12.5	< 30	$\varnothing \geq 11$	A + 12.5	M10 Hex Socket	270
HGM/HGE 630, 800	< 12.5	< 45	$\varnothing \geq 13$	A + 12.5	M12 Hex Socket	470

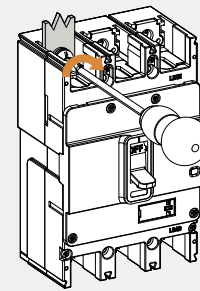
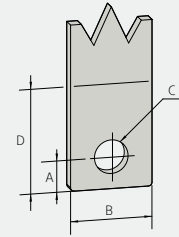

Crimped Terminal

It is necessary to follow the specifications and choose the correct cable size for the terminal. The crimped terminal must be used with the insulation barrier and terminal cover. Additional terminal is not supplied

Application		Cu Cable Size (mm ²)	Applicable Terminal Dimensions (mm)	
Type	Rated Current		A	B
HGM/HGE 30, 50E/S, 60, 100	32	6	$\varnothing \geq 5.5$	< 18
	50	10	$\varnothing \geq 5.5$	
	63	16	$\varnothing \geq 9$	
	100	35	$\varnothing \geq 9$	
HGM/HGE 50H/L, 125	50	10	$\varnothing \geq 9$	< 21
	125	50	$\varnothing \geq 9$	< 21
HGM/HGE 160, 250	160	70	$\varnothing \geq 9$	< 28
	250	120	$\varnothing \geq 9$	< 28
HGM/HGE 400	400	240	$\varnothing \geq 11$	< 30
HGM/HGE 630, 800	800	240 x 2	$\varnothing \geq 13$	< 45

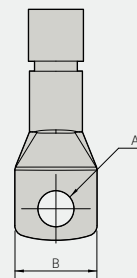

Busbar

Straight Busbar

- Used to meet the size of the cable or standards of the switchgear. (No change of the pitch between the poles)

Extended Busbar

- Used to extend the insulation distance. (Extension of the pitch between the poles)

Application		Straight Busbar		Extended Busbar (Spreader)	
Type	Pole	Type	Pitch	Type	Pitch
HGM/HGE 160, 250	2	TBB 25GP 2S	35 mm	-	45 mm
	3	TBB 25GP 3S		TBB 25GP 3E45	
	4	TBB 25GP 4S		TBB 25GP 4E45	
HGM/HGE 400	2	TBB 40GM 2S	44 mm	-	59 mm
	3	TBB 40GM 3S		TBB 40GM 3E59	
	4	TBB 40GM 4S		TBB 40GM 4E59	
HGM/HGE 630	2	TBB 63GM 2S	70 mm	-	-
	3	TBB 63GM 3S		-	
	4	TBB 63GM 4S		-	
HGM/HGE 800	2	TBB 80GM 2S	70 mm	-	-
	3	TBB 80GM 3S		-	
	4	TBB 80GM 4S		-	

※ Quantity per set : 2P - 2 EA, 3P - 3 EA, 4P - 4 EA



Straight Busbar



Extended Busbar
(Spreader)

LUG Terminal

Used to connect the cable to circuit breakers without crimped terminal. It should be used according to size of cable and rating of product.

Application		LUG Terminal			Application			Tightening Torque (kgf x cm)
Type	Pole	Type	Material	EA	Material	S (mm ²)	L (mm)	
HGM/HGE 30, 50E/S, 60, 100 (≤ 50 A)	2	CTB 10GM 2S50	Al	1	Cu/Al	2.5 - 16	14	60
	3	CTB 10GM 3S50						
	4	CTB 10GM 4S50						
HGM/HGE 60, 100 (> 50 A)	2	CTB 10GM 2S100	Al	1	Cu/Al	16 - 50	14	60
	3	CTB 10GM 3S100						
	4	CTB 10GM 4S100						
HGM/HGE 50H/L, 125	2	CTB 12GM 2S	Al	1	Cu/Al	2.5 - 70	14	60
	3	CTB 12GM 3S						
	4	CTB 12GM 4S						
HGM/HGE 160, 250	2	CTB 25GM 2S	Al	1	Cu/Al	50 - 180	19	140
	3	CTB 25GM 3S						
	4	CTB 25GM 4S						
HGM/HGE 400	3	CTB 40GM 3S1H	Al	1	Cu/Al	60 - 240 60 - 125	30 - 60	353
	4	CTB 40GM 4S1H						
HGM/HGE 400	3	CTB 40GM 3S	Al	2	Cu/Al	60 - 240	30 - 60	353
	4	CTB 40GM 4S						
HGM/HGE 630, 800	3	CTB 80GM 3S	Al	3	Cu/Al	60 - 185	30 - 60	353
	4	CTB 80GM 4S						

※ Quantity per set: 2P - 2 EA, 3P - 3 EA, 4P - 4 EA

※ Above are inch type and HGM100 - 250 has ISO type.



Wire



HGM100, 125, 250



HGM400

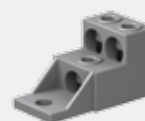

HGM800

External Accessories

Plug-in Connection Devices

Circuit breakers can be replaced quickly without cable separation by using Plug-in connection type.

It is more convenient to apply Plug-in type circuit breakers for important electric system (shipping, broadcasting etc).

- Easy and convenient to maintain and repair the switchgear.
- It is possible to remove/replace the circuit breaker quickly without contacting the terminal.
- Type: For switchboard (TDM/TDF), For panel board (TDA)
- Constitution: Plug-in devices, plug-in MCCB, terminal cover or Insulation barrier (Option)

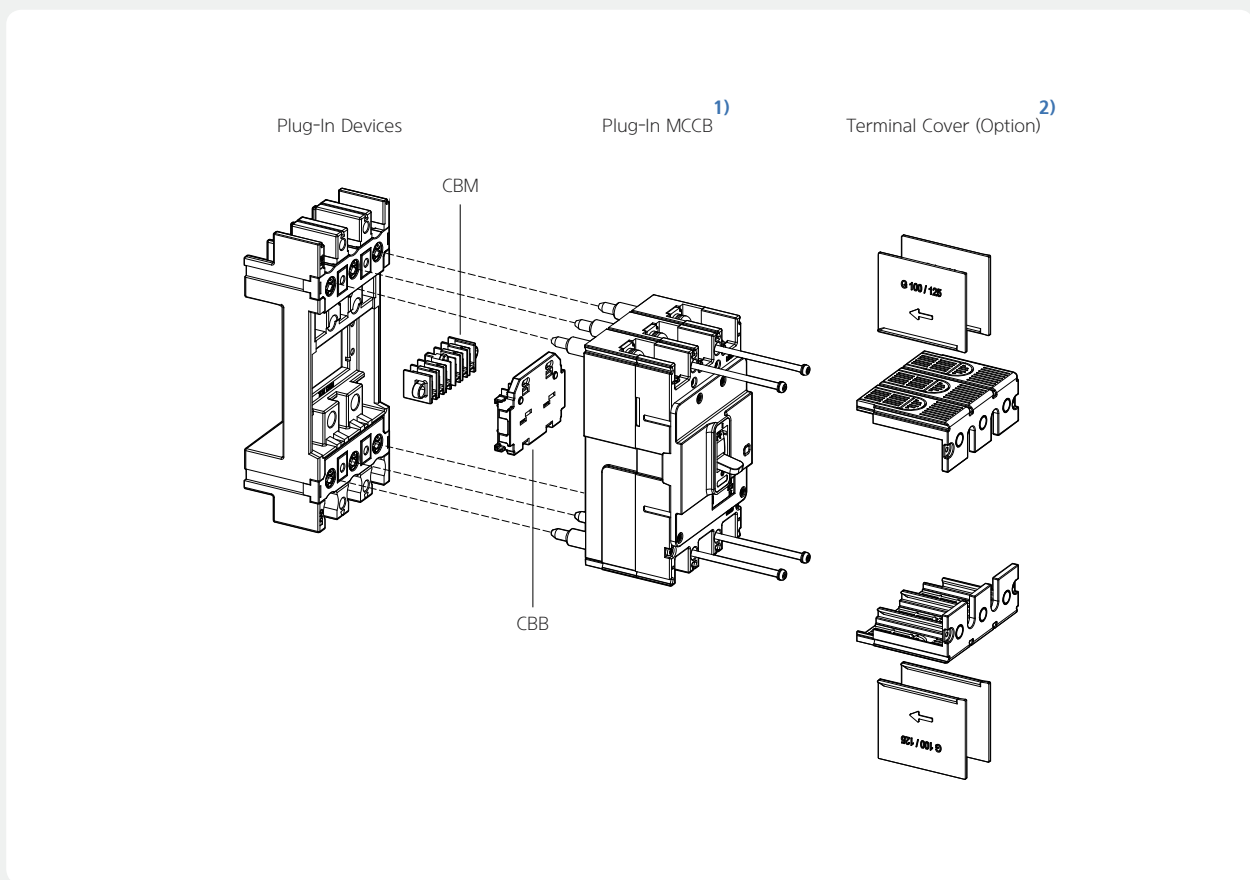

※ 1) In order to use plug-in connection devices, please apply the plug-in type MCCB.

2) In case of not using terminal cover, please install insulation barrier.

HG-MCCB Plug-in CBM Wiring Position (TDM Front Side)

OPTION	HGM30, 50E/S, 60, 100 / 2P	HGM30, 50E/S, 60, 100	HGM50H/L, 125, 160, 250	HGM400, 630, 800	HGP50D, 125D, 160D	HGP250	HGP630	HGP800
AUX								
AUX2								
AUX3								
ALT								
SHT/UVT								
AUX+ALT								
AUX2+ALT								
AUX3+ALT								
AUX+SHT/UVT								
AUX2+SHT/UVT								
AUX3+SHT/UVT								
ALT+SHT/UVT								
AUX+ALT+SHT/UVT								
AUX+ALT+SHT/UVT								

External Accessories

Plug-in Devices



This device is used to connect plug-in MCCB to switchgear.

TDM Type

- TDM-P: Both LINE and LOAD sides consist of plug-in terminal.
- TDM-F: Only LINE side consists of plug-in terminal.

TDF Type

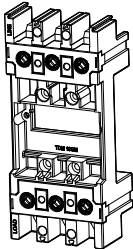
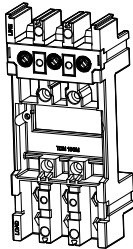
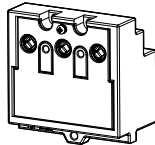
- Only LINE side consists of plug-in terminal but available for fixing plug-in device at switchgear as same as TDM-P

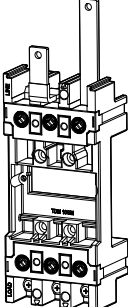
Application	For Switchgear			For Panel Board	
	Type	TDM-P	TDM-F	TDF	TDA (2 row)
Composition					
Use	LINE/LOAD	LINE	LINE	Duble base	Single base
HGM/HGE Type	32 - 800 AF	32 - 800 AF	32 - 125 AF	32 - 125 AF	32 - 125 AF
Pole	3P	3P	3P	2P (100 AF only), 3P	3P

Connection Busbar

It is used for connecting switchgear busbar to plug-in device directly.

The specifications of the applicable busbar are as follows.

(unit: mm)

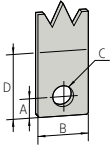
Application	A	B	C	D	Remark
HGM/HGE30, 50E/S, 60, 100	< 10	< 21	$\varnothing \geq 6.5$	< 17.5	
HGM/HGE50H/L, 125	< 10	< 21	$\varnothing \geq 6.5$	< 19.5	
HGM/HGE160, 250	< 17.5	< 25	$\varnothing \geq 8.5$	< 27.5	
HGM/HGE400	< 22	< 32	$\varnothing \geq 10.5$	< 38	
HGM/HGE630, 800	< 30	< 40	$\varnothing \geq 17$	< 48.5	

(unit: mm)

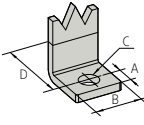
Application	A	B	C	D	Remark
HGM/HGE30, 50E/S, 60, 100	< 7.5	< 15	$\varnothing \geq 7$	< 13	
HGM/HGE50H/L, 125	< 7.5	< 15	$\varnothing \geq 7$	< 13	
HGM/HGE160, 250	-	-	-	-	
HGM/HGE400	-	-	-	-	
HGM/HGE630, 800	-	-	-	-	

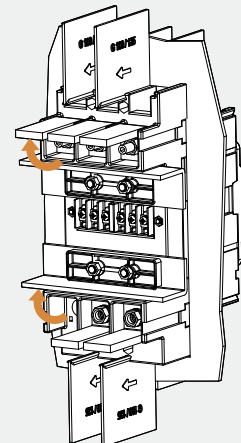

Rear Connection Terminal

This device is used for connecting MCCB from rear side of switchgear.

It is possible to array buabar vertically or horizontally according to assembling direction of connection.

Flat Type

Application		Rear Connection of Fixed Devices		Quantity Per Set	
Type	Pole	LINE	LOAD	Short Terminal	Long Terminal
HGM/HGE30, 50E/S, 60, 100 (≤ 50 A)	2	RCT 05GM F2	RCT 05GM F2	1	1
	3	RCT 05GM F3	RCT 05GM F3	2	1
	4	RCT 05GM F4	RCT 05GM F4	2	2
HGM/HGE 60, 100 (> 50 A)	2	RCT 10GM F2	RCT 10GM F2	1	1
	3	RCT 10GM F3	RCT 10GM F3	2	1
	4	RCT 10GM F4	RCT 10GM F4	2	2
HGM/HGE 50H/L, 125	2	RCT 12GM F2	RCT 12GM F2	1	1
	3	RCT 12GM F3	RCT 12GM F3	2	1
	4	RCT 12GM F4	RCT 12GM F4	2	2
HGM/HGE 160, 250	2	RCT 25GM F2 LINE	RCT 25GM F2 LOAD	1	1
	3	RCT 25GM F3 LINE	RCT 25GM F3 LOAD	2	1
	4	RCT 25GM F4 LINE	RCT 25GM F4 LOAD	2	2
HGM/HGE 400	3	RCT 63GP F3 LINE	RCT 63GP F3 LOAD	2	1
	4	RCT 63GP F4 LINE	RCT 63GP F4 LOAD	2	2
HGM/HGE 630, 800	3	RCT 80GP F3 LINE	RCT 80GP F3 LOAD	2	1
	4	RCT 80GP F4 LINE	RCT 80GP F4 LOAD	2	2

Short Terminal



Long Terminal



HGM30 - 250
HGE30 - 250

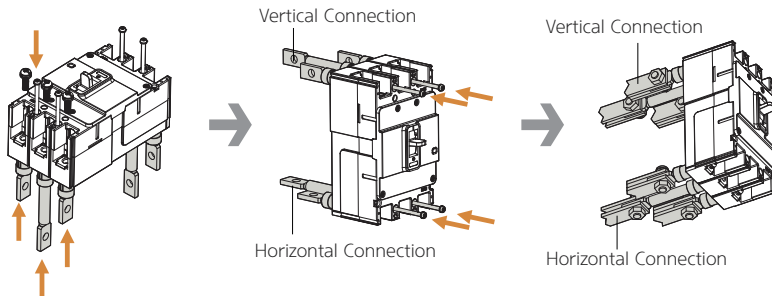

DIN Rail Adaptor

This device is used for DIN rail mounting of MCCB. (HGM/HGE100 Only)

Application		DIN Rail Adaptor	Quantity
Type	Pole		
HGM/HGE 30, 50E/S, 60, 100	2	DRA 10GM	1
	3	DRA 10GM	1
	4	DRA 10GM	2

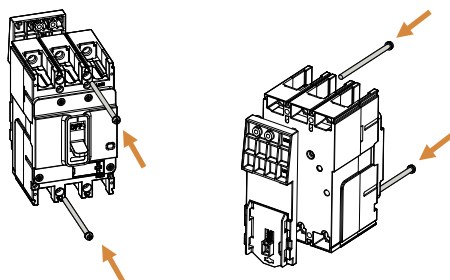

※ Please remove backbarriers when assembling the DRA

External Accessories

Motor Operator

This device is used for turning ON/OFF circuit breakers from remote position. It can be applied at low-voltage automation system or emergency power system.

Application		MOT	Control Voltage
Type	Pole		
HGM30, 50E/S, 60, 100	3, 4	MOT 10GM	DC24 V AC/DC110 V AC/DC240 V
HGM50H/L, 125	3, 4	MOT 12GM	
HGM160, 250	3, 4	MOT 25GM	
HGM400	3, 4	MOT 40GM	
HGM630, 800	3, 4	MOT 80GM	



- ※ Note
- Motor operator should be attached, only when MCCB's handle is OFF.
 - If not, there is possibility of burning the motor.

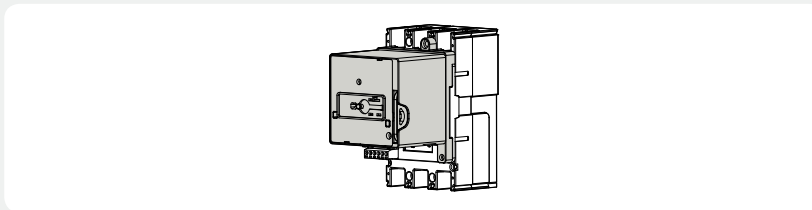

Ratings

Application	Mechanical Lifetime	Control Voltage	Operating Current	Operation Time (ms)		Power Consumption (W)
				Closing	Opening	
MOT 10GM	10,000	DC24 V	≤ 2.5	310	200	14
		AC/DC110 V	≤ 0.5			
		AC/DC240 V	≤ 0.5			
MOT 12GM	10,000	DC24 V	≤ 2.5	350	230	14
		AC/DC110 V	≤ 0.5			
		AC/DC240 V	≤ 0.5			
MOT 25GM	8,000	DC24 V	≤ 2.5	350	230	14
		AC/DC110 V	≤ 0.5			
		AC/DC240 V	≤ 0.5			
MOT 40GM	5,000	DC24 V	≤ 6.0	500	350	14
		AC/DC110 V	≤ 3.0			
		AC/DC240 V	≤ 2.0			
MOT 80GM	5,000	DC24 V	≤ 6.0	500	350	35
		AC/DC110 V	≤ 3.0			
		AC/DC240 V	≤ 2.0			

※ Voltage range: 85 - 110 % (DC24 V: 95 - 110 %)

Control Circuit Diagram

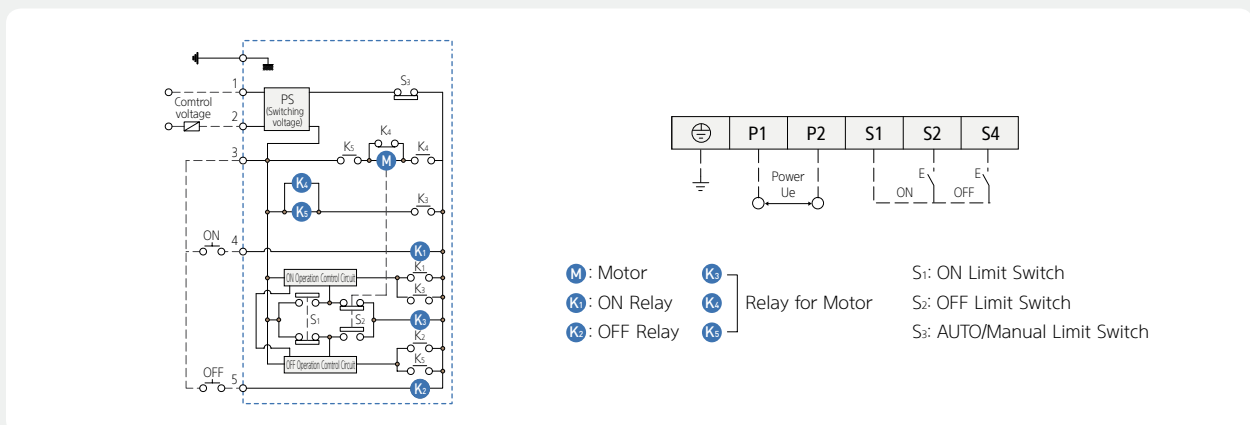

Technical Information

Standard Use Environment	54
Degree of Protection	57
Power Losses & Resistance	58
Cascading Table	60
Installation	64
Standard Configuration	66
MCCB/ELCB Assembly and Terminal Mounting Specification	67

Technical Information

Standard Use Environment

Temperature Derating

Overcurrent characteristics of MCCB has been set to the ambient temperature 40 degrees celsius. If the ambient temperature is less or more than 40 degrees celsius, the overcurrent characteristics can be changed.

If the Ambient Temperature is Less than 40 Degrees Celsius

In order to ensure that circuit breaker's overcurrent meet the derating curve at the given ambient temperature, the rear current (Ir) should be adjusted. The temperature correction ratio for each MCCB is shown on the circuit breaker derating curve.

If the Ambient Temperature is More than 40 Degrees Celsius

If the internal temperature of the MCCB is over 40 degrees, thermal damage to the insulating material inside the MCCB can occur causing the circuit breaker to trip at an early stage. When applying ambient temperatures at higher than 40 degrees celsius, you must adjust the rated current as shown in the rated current correction table below.

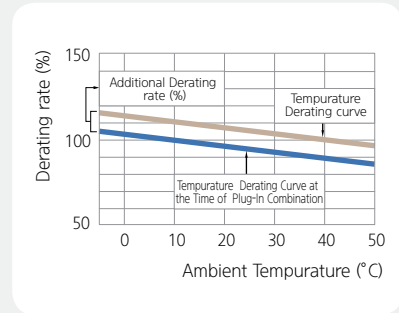

In (Rated Current): Circuit breaker's rating at about ambient temperature 40 °C

Ir (Real Current): Circuit breaker's rating at about ambient temperature

$I_r = \text{Correction ratio (\%)} \times I_n$



Rated Current Derating Tabel: HG Type / Standard Mounting (Fixed)

Model	Rated Current (A)	Ambient Temperature (°C)										
		(A)	20	30	40	45	50	55	60	65	70	
HGM/HGE 30, 50E/S, 60, 100	16	18.9	18.6	17.8	16	15.2	14.6	14.1	13.6	13.2	12.8	
	20	23.58	23.3	22.2	20	19.1	18.3	17.6	17.0	16.5	16.0	
	25	26.8	26.2	25.6	25	24.7	24.4	24.1	23.8	23.5	23.2	
	32	34.3	33.5	32.8	32	31.6	31.3	30.9	30.5	30.1	29.7	
	40	42.9	41.9	41.0	40	39.5	39.0	38.6	38.1	37.6	37.1	
	50	53.6	52.4	51.2	50	49.4	48.8	48.2	47.6	47.0	46.4	
	63	67.5	66.0	64.5	63	62.2	61.5	60.7	60.0	59.2	58.5	
	75	80.4	78.6	76.8	75	74.1	73.2	72.3	71.4	70.5	69.6	
	80	85.8	83.8	81.9	80	79.0	78.1	77.1	76.2	75.2	74.2	
HGM/HGE 50H/L, 125	16	18.9	18.6	17.8	16	15.2	14.6	14.1	13.6	13.2	12.8	
	20	23.6	23.3	22.2	20	19.1	18.3	17.6	17.0	16.5	16.0	
	25	27.3	26.6	25.8	25	24.6	24.2	23.8	23.4	23.0	22.6	
	32	35.0	34.0	33.0	32	31.5	31.0	30.5	30.0	29.5	29.0	
	40	43.8	42.5	41.3	40	39.4	38.8	38.1	37.5	36.8	36.2	
	50	54.7	53.1	51.6	50	49.2	48.4	47.7	46.9	46.1	45.3	
	63	68.9	66.9	65.0	63	62.0	61.0	60.1	59.1	58.0	57.0	
	75	82.0	79.7	77.3	75	73.8	72.7	71.5	70.3	69.1	67.9	
	80	87.5	85.0	82.5	80	78.8	77.5	76.3	75.0	73.7	72.4	
HGM/HGE 160, 250	100	109.4	106.3	103.1	100	98.4	96.9	95.3	93.8	92.1	90.5	
	125	136.7	132.8	128.9	125	123.1	121.1	119.1	117.2	115.1	113.1	
	100	107.8	105.2	102.6	100	96.0	94.0	92.0	88.0	85.5	83.0	
	125	134.8	131.5	128.3	125	120.0	117.5	115.0	110.0	106.9	103.8	
	150	161.7	157.8	153.9	150	144.0	141.0	138.0	132.0	128.3	124.5	
	160	172.5	168.3	164.2	160	153.6	150.4	147.2	140.8	136.8	132.8	
	175	188.7	184.1	179.6	175	168.0	164.5	161.0	154.0	149.6	145.3	
	200	215.6	210.4	205.2	200	192.0	188.0	184.0	176.0	171.0	166.0	
225	242.6	236.7	230.9	225	216.0	211.5	207.0	198.0	192.4	186.8		
250	269.5	263.0	256.5	250	240.0	235.0	230.0	220.0	213.8	207.5		



Rated Current Derating Tabel: HG Type / Standard Mounting (Fixed)

Model	Rated current (A)	Ambient temperature (°C)									
		10	20	30	40	45	50	55	60	65	70
HGM/HGE 400	250	269.5	263.0	256.5	250	246.8	243.5	240.2	237.0	233.6	230.3
	300	324	316.5	309	300	291	282	273	264	255	246
	350	378	369.25	360.5	350	340	330	320	310	300	290
	400	432	422	412	400	388	376	364	352	340	328
HGM/HGE 630, 800	500	540	527.5	515	500	485	470	455	440	425	410
	630	680.4	664.65	648.9	630	611	592	573	554	535	516
	700	756	738.5	721	700	679	658	637	616	595	574
	800	864	844	824	800	776	752	728	704	680	656



Rated Current Derating Tabel: HG Type / Plug-In Type

Model	Rated Current (A)	Ambient Temperature (°C)									
		10	20	30	40	45	50	55	60	65	70
HGM/HGE 30, 50E/S, 60, 100	16	18.5	18.3	17.4	16	14.9	14.3	13.8	13.3	12.9	12.5
	20	23.1	22.8	21.8	20	18.7	17.9	17.2	16.7	16.1	15.7
	25	26.3	25.7	25.1	25	24.2	23.9	23.6	23.3	23.0	22.7
	32	33.6	32.9	32.1	31	31.0	30.6	30.2	29.9	29.5	29.1
	40	42.0	41.1	40.1	39	38.7	38.3	37.8	37.3	36.8	36.4
	50	52.5	51.4	50.2	49	48.4	47.8	47.2	46.6	46.1	45.5
	63	66.2	64.7	63.2	62	61.0	60.3	59.5	58.8	58.0	57.3
	75	78.8	77.0	75.3	74	72.6	71.7	70.9	70.0	69.1	68.2
	80	84.0	82.2	80.3	78	77.5	76.5	75.6	74.6	73.7	72.8
HGM/HGE 50H/L, 125	16	18.5	18.2	17.4	16	14.9	14.3	13.8	13.3	12.9	12.5
	20	23.1	22.8	21.8	20	18.7	17.9	17.2	16.7	16.1	15.7
	25	26.8	26.0	25.3	25	24.1	23.7	23.4	23.0	22.6	22.2
	32	34.3	33.3	32.3	31	30.9	30.4	29.9	29.4	28.9	28.4
	40	42.9	41.7	40.4	39	38.6	38.0	37.4	36.8	36.1	35.5
	50	53.6	52.0	50.5	49	48.2	47.5	46.7	45.9	45.1	44.4
	63	67.5	65.6	63.7	62	60.8	59.8	58.8	57.9	56.9	55.9
	75	80.4	78.1	75.8	74	72.4	71.2	70.1	68.9	67.7	66.5
	80	85.8	83.3	80.9	78	77.2	76.0	74.7	73.5	72.2	71.0
HGM/HGE 160, 250	100	107.2	104.1	101.1	98	96.5	94.9	93.4	91.9	90.2	88.7
	125	134.0	130.2	126.3	123	120.6	118.7	116.8	114.8	112.8	110.9
	100	103.5	101.0	98.5	96	92.2	90.2	88.3	84.5	82.1	79.7
	125	129.4	126.2	123.1	120	115.2	112.8	110.4	105.6	102.6	99.6
	150	155.3	151.5	147.8	144	138.2	135.4	132.5	126.7	123.1	119.5
	160	165.6	161.6	157.6	154	147.5	144.4	141.3	135.2	131.3	127.5
	175	181.1	176.7	172.4	168	161.3	157.9	154.6	147.8	143.6	139.4
	200	207.0	202.0	197.0	192	184.3	180.5	176.6	169.0	164.2	159.4
HGM/HGE 400	225	232.9	227.3	221.6	216	207.4	203.0	198.7	190.1	184.7	179.3
	250	258.7	252.5	246.2	240	230.4	225.6	220.8	211.2	205.2	199.2
	250	261.4	255.1	248.8	242.5	239.3	236.2	233.0	229.9	226.6	223.4
	300	314.3	307.0	299.7	291.0	282.3	273.5	264.8	256.1	247.4	238.6
HGM/HGE 630, 800	350	366.7	358.2	349.7	339.5	329.8	320.1	310.4	300.7	291.0	281.3
	400	405.2	395.8	387.6	378	373.7	367.9	363.2	357.9	352.6	347.3
	500	523.8	511.7	499.6	485.0	470.5	455.9	441.4	426.8	412.3	397.7
	630	660.0	644.7	629.4	611.1	592.7	574.2	555.8	537.4	519.0	500.5
HGM/HGE 630, 800	700	725.8	709.0	692.2	672.0	651.8	631.7	611.5	591.4	571.2	551.0
	800	777.8	759.7	744.1	726	717.4	706.3	697.3	687	676.9	666.7

Technical Information

Altitude Derating

It does not affect the characteristics of circuit breaker at an altitude of less than 2000 m. Characteristics of insulation and air cooling are reduced at an altitude of more than 2000 m. You should adjust rated current and rated voltage as shown in the table below at an altitude of more than 2000m. However, this will not change the characteristics of the circuit breaker.

Circuit Breaker	Altitude	2,000 m	3,000 m	4,000 m	5,000 m
HGM type MCCB 32 - 800 AF	Withstand voltage (V)	3,000	2,500	2,100	1,800
	Insulation voltage (V) U_i	1,000	850	750	600
	Maximum operational voltage (V) U_e	690	590	520	460
	Average through-current (A) at the temperature of 40 °C $I_n \times$	1	0.96	0.93	0.9
HGE type ELCB 32 - 800 AF	Withstand voltage (V)	3,000	2,500	2,100	1,800
	Insulation voltage (V) U_i	800	700	600	500
	Maximum operational voltage (V) U_e	460	390	345	275
	Average through-current (A) at the temperature of 40 °C $I_n \times$	1	0.96	0.93	0.9

Vibrations

The excessive vibration makes some troubles in the breakage of circuit breaker, the dynamic strength of failure, electric current, carrying and the safety operating characteristics so, choosing the circuit breaker, you need proper consideration in these environmental stress. These stress is generated by the magnetic impact of operating open and close test, vibration during transport, and the influence of adjacent equipment. Our circuit breaker is verified by test in accordance with standard of internal impulse performance.

Vibrations Test

Vibration test carried out in compliance to the IEC 60068-2-6 standards for vibration to ensure the level that the shipping certificate authority requests. The test verifies the resonance performance and vibration durability based on the following

Resonance Test

You can alter the frequency as shown in the following range of sinusoidal wave to see if there is any occurrence of vibration on a specific part of MCCB.

- 5 - 13.2 (Hz): Displacement amplitude 1 mm
- 3.2 - 100 (Hz): Acceleration amplitude 0.7 g

Vibration Durability Test

A sinusoidal wave with frequency of 30 Hz is manually created to check the operational status for 90 minutes.

- 30 (Hz): Acceleration amplitude 0.7 g

Seismic Performance and Shock Tolerance Chart

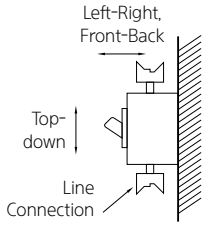
Part		Seismic Performance
Test condition	Vibration posture, Direction of impulse	<ul style="list-style-type: none"> • Vertical mounting • Top-down, Left-right, Front-back 
	Status of MCCB	<ul style="list-style-type: none"> • Non-conduction (ON or OFF status) • Status where rated current has been conducted on until the temperature of MCCB becomes constant and continuous.
Test result	Judgement condition	<ul style="list-style-type: none"> • If it is ON, it should not be OFF • If it is OFF, it should not be ON • No abnormal status such as damage, transformation, or annealing of nut part • The characteristics of switch and trip after the test must be normal

Degree of Protection

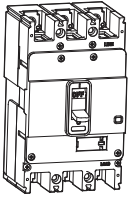
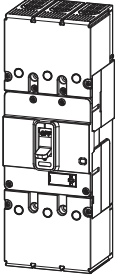
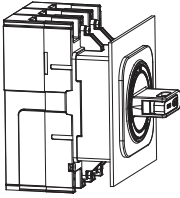
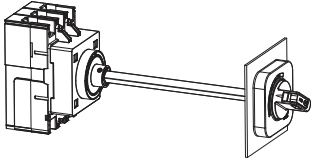

By stipulating the IP degree of MCCB based on IEC 60529 standard, the IP degree is changed according to the product condition.

Condition	Circuit Breaker	Circuit Breaker + Terminal Cover	Circuit Breaker + Terminal Cover + Rotary Handle (Front Contact)	Circuit Breaker + Terminal Cover + Rotary Handle (Extended)
Exteriors				
Degree of protection	IP20	IP40	IP40	IP40



Technical Information

Power Consumption & Resistance

HGM Type MCCB

Type	Rated Current (A)	HGM30, 50E/S, 60, 100		HGM50H/L, 125		HGM160, 250		HGM400		HGM630, 800	
		R/Pole (mΩ)	P/Pole (W)	R/Pole (mΩ)	P/Pole (W)	R/Pole (mΩ)	P/Pole (W)	R/Pole (mΩ)	P/Pole (W)	R/Pole (mΩ)	P/Pole (W)
Fixed / Adj 	16	16.0	4.10	17.0	4.35						
	20	16.0	6.40	17.0	6.80						
	25	4.0	2.50	4.3	2.69						
	32	4.0	4.10	3.0	3.07						
	40	2.9	4.64	2.6	4.16						
	50	2.3	5.75	1.7	4.25						
	63	1.7	6.75	1.3	5.16						
	75	1.2	6.75	1.0	5.63						
	80	0.9	5.76	1.0	6.40						
	100	0.9	9.00	0.7	6.50	0.6	5.60				
	125			0.6	9.38	0.4	6.72				
	150					0.4	8.55				
	160					0.3	8.70				
	175					0.3	9.80				
	200					0.3	10.80				
	225					0.3	13.67				
	250					0.2	13.75	0.2	14.38		
	300							0.2	18.90		
	350							0.2	23.28		
	400							0.2	27.20		
500									0.1	32.50	
630									0.1	43.20	
700									0.1	53.90	
800									0.1	64.00	
Plug-in 	16	16.1	4.12	17.1	4.37						
	20	16.1	6.43	17.1	6.83						
	25	4.1	2.55	4.4	2.74						
	32	4.1	4.18	3.1	3.15						
	40	3.0	4.77	2.7	4.29						
	50	2.4	5.95	1.8	4.45						
	63	1.8	7.06	1.4	5.48						
	75	1.3	7.20	1.1	6.08						
	80	1.0	6.27	1.1	6.91						
	100	1.0	9.80	0.7	7.30	0.6	6.40				
	125			0.7	10.63	0.5	7.97				
	150					0.5	10.35				
	160					0.4	10.75				
	175					0.4	12.25				
	200					0.4	14.00				
	225					0.4	17.72				
	250					0.3	18.75	0.3	19.38		
	300							0.3	26.10		
	350							0.3	33.08		
	400							0.3	40.00		
500									0.2	52.50	
630									0.2	72.00	
700									0.2	93.10	
800									0.2	115.20	

HGE Type ELCB

Type	Rated Current (A)	HGE30, 50E/S, 60, 100		HGE50H/L, 125		HGE160, 250		HGE400		HGE630, 800	
		R/Pole (mΩ)	P/Pole (W)	R/Pole (mΩ)	P/Pole (W)	R/Pole (mΩ)	P/Pole (W)	R/Pole (mΩ)	P/Pole (W)	R/Pole (mΩ)	P/Pole (W)
Fixed 	16	14.3	3.66	12.9	3.30						
	20	14.3	5.72	12.9	5.16						
	25	4.9	3.04	4.2	2.63						
	32	4.9	4.98	3.9	4.00						
	40	2.9	4.64	3.0	4.85						
	50	2.4	6.03	1.8	4.49						
	63	2.1	8.49	1.7	6.59						
	75	1.3	7.14	1.1	6.40						
	80	1.0	6.65	1.1	7.28						
	100	1.0	9.77	0.8	8.42	0.5	5.44				
	125			0.7	11.56	0.5	7.32				
	150					0.4	8.10				
	160					0.3	8.67				
	175					0.3	10.06				
	200					0.3	11.37				
	225					0.3	14.65				
	250					0.2	15.13	0.3	16.25		
	300							0.2	21.60		
	350							0.2	26.95		
	400							0.2	32.00		
500									0.2	40.00	
630									0.2	54.00	
700									0.1	68.60	
800									0.1	83.20	
Plug-in 	16	14.3	3.66	12.9	3.30						
	20	14.3	5.72	12.9	5.16						
	25	4.9	3.04	4.4	2.75						
	32	4.9	4.98	3.9	4.00						
	40	2.9	4.64	3.0	4.85						
	50	2.4	6.03	1.8	4.49						
	63	2.1	8.49	1.7	6.59						
	75	1.3	7.14	1.1	6.40						
	80	1.0	6.65	1.1	7.28						
	100	1.0	9.77	0.8	8.42	0.5	5.44				
	125			0.7	11.56	0.5	7.32				
	150					0.4	8.10				
	160					0.3	8.67				
	175					0.3	10.06				
	200					0.3	11.37				
	225					0.3	14.65				
	250					0.2	15.13	0.3	21.25		
	300							0.3	28.80		
	350							0.3	36.75		
	400							0.3	44.80		
500									0.2	60.00	
630									0.2	82.80	
700									0.2	107.80	
800									0.2	134.40	

Technical Information

Cascading Table

AC220/240 V

Upstream: HGM30, HGM50, HGM60, HGM100, HGM125, HGM160, HGM250, HGM400

Downstream: HiBD63, HiBD125, HGM30, HGM50, HGM60, HGM100

Upstream	HGM30		HGM50				HGM60				HGM100			
	E	S	E	S	H	L	E	S	H	L	E	S	H	L
Breaking capacity [Icu] (kA r.m.s.)	35	50	35	50	85	100	35	50	50	50	35	50	50	50
Downstream breaking capacity [Icu] (kA r.m.s.)	Enhanced breaking capacity													
HiBD63E	10	15	15	15	15	15	15	15	15	15	15	15	15	15
HiBD63S	15	20	20	20	20	20	20	20	20	20	20	20	20	20
HiBD63N	20			35	40	40	40	35	40	40	40	35	40	40
HiBD63H	25			35	50	50	50	35	40	40	40	35	40	40

Upstream	HGM125				HGM160				HGM250			
	E	S	H	L	E	S	H	L	E	S	H	L
Breaking capacity [Icu] (kA r.m.s.)	50	65	85	100	50	65	85	100	50	65	85	100
Downstream breaking capacity [Icu] (kA r.m.s.)	Enhanced breaking capacity											
HiBD63E	10	15	15	15	15	15	15	15	15	15	15	15
HiBD63S	15	20	20	20	20	20	20	20	20	20	20	20
HiBD63N	20	40	40	40	40	40	40	40	40	40	40	40
HiBD63H	25	40	50	50	50	40	50	50	50	40	50	50
HiBD125	25	40	40	40	40	40	40	40	40	40	40	40

Upstream	HGM30		HGM50				HGM60				HGM100			
	E	S	E	S	H	L	E	S	H	L	E	S	H	L
Breaking capacity [Icu] (kA r.m.s.)	35	50	35	50	85	100	35	50	50	50	35	50	50	50
Downstream breaking capacity [Icu] (kA r.m.s.)	Enhanced breaking capacity													
HGM30E	35		50		50	65	65		50	50	50		50	50
HGM50E	35				50	65	70		50	50	50		50	50
HGM50S	50				70	85								
HGM50H	85					100								
HGM60E	35								50	50	50		50	50
HGM100E	35												50	50

Upstream	HGM125				HGM160				HGM250				HGM400				
	E	S	H	L	E	S	H	L	E	S	H	L	E	S	H	L	
Breaking capacity [Icu] (kA r.m.s.)	50	65	85	100	50	65	85	100	50	65	85	100	50	75	100	125	
Downstream breaking capacity [Icu] (kA r.m.s.)	Enhanced breaking capacity																
HGM30E	35	50	65	65	65	50	65	65	65	50	65	65	65	50	65	65	65
HGM30S	50		65	65	65		65	65	65		65	65	65		65	65	65
HGM50E	35	50	65	65	70	50	65	65	70	50	65	65	70	50	65	65	70
HGM50S	50		65	70	85		65	70	85		65	70	85		65	70	85
HGM50H	85				100				100				100				100
HGM60E	35	50	65	70	70	50	65	70	70	50	65	70	70	50	65	70	70
HGM60S	50		65	70	70		65	70	70		65	70	70		65	70	70
HGM60H	50		65	70	70		65	70	70		65	70	70		65	70	70
HGM60L	50		65	70	70		65	70	70		65	70	70		65	70	70
HGM100E	35	50	65	70	70	50	65	70	70	50	65	70	70	50	65	70	70

AC220/240 V

Upstream: HGM125, HGM160, HGM250, HGM400, HGM630, HGM800

Downstream: HGM100, HGM160, HGM250, HGM400, HGM630, HGM800

Upstream	HGM125				HGM160				HGM250				HGM400			
	E	S	H	L	E	S	H	L	E	S	H	L	E	S	H	L
Breaking capacity [Icu] (kA r.m.s.)	50	65	85	100	50	65	85	100	50	65	85	100	50	75	100	125
Downstream breaking capacity [Icu] (kA r.m.s.)	Enhanced breaking capacity															
HGM100S	50	65	70	70		65	70	70		65	70	70		65	70	70
HGM100H	50	65	70	70		65	70	70		65	70	70		65	70	70
HGM100L	50	65	70	70		65	70	70		65	70	70		65	70	70
HGM125E	50	65	85	100		65	85	100		65	85	100		65	85	100
HGM125S	65		85	100			85	100			85	100			85	100
HGM125H	85			100				100				100				100

Upstream	HGM160				HGM250				HGM400			
	E	S	H	L	E	S	H	L	E	S	H	L
Breaking capacity [Icu] (kA r.m.s.)	50	65	85	100	50	65	85	100	50	75	100	125
Downstream breaking capacity [Icu] (kA r.m.s.)	Enhanced breaking capacity											
HGM160E	50	65	85	100		65	85	100		75	85	100
HGM160S	65		85	100			85	100			85	100
HGM160H	85			100				100			100	125
HGM160L	100											125
HGM250E	50					65	85	100		75	85	100
HGM250S	65						85	100			85	100
HGM250H	85							100			100	125
HGM250L	100											125

Upstream	HGM630				HGM800		
	E	S	H	L	S	H	L
Breaking capacity [Icu] (kA r.m.s.)	50	75	100	125	75	100	125
Downstream breaking capacity [Icu] (kA r.m.s.)	Enhanced breaking capacity						
HGM250E	50	75	85	100	75	85	100
HGM250S	65		85	100		85	100
HGM250H	85		100	125		100	125
HGM250L	100			125			125
HGM400E	50	75	85	100	75	85	100
HGM400S	75		85	100		85	100
HGM400H	100			125			125
HGM630E	50	75	85	100	75	85	100
HGM630S	75		85	100		85	100
HGM630H	100			125			125
HGM800S	75					70	85
HGM800H	100						85

Technical Information

Cascading Table

AC440/460 V

Upstream: HGM30, HGM50, HGM60, HGM100, HGM125, HGM160, HGM250, HGM400

Downstream: HiBD63, HiBD125, HGM30, HGM50, HGM60, HGM100

Upstream	HGM30		HGM50				HGM60				HGM100			
	E	S	E	S	H	L	E	S	H	L	E	S	H	L
Breaking capacity [Icu] (kA r.m.s.)	16	20	16	20	38	55	16	20	26	30	16	20	26	30
Downstream breaking capacity [Icu] (kA r.m.s.)	Enhanced breaking capacity													
HiBD63E	6	10	10	10	10	10	10	10	10	10	10	10	10	10
HiBD63S	7.5	14	14	14	14	14	14	14	14	14	14	14	14	14
HiBD63N	10			16	20	20	20	16	20	20	20	16	20	20
HiBD63H	15			16	20	26	26	16	20	20	20	16	20	20

Upstream	HGM125				HGM160				HGM250			
	E	S	H	L	E	S	H	L	E	S	H	L
Breaking capacity [Icu] (kA r.m.s.)	20	26	38	55	20	26	38	55	20	26	38	55
Downstream breaking capacity [Icu] (kA r.m.s.)	Enhanced breaking capacity											
HiBD63E	6	10	10	10	10	10	10	10	10	10	10	10
HiBD63S	7.5	14	14	14	14	14	14	14	14	14	14	14
HiBD63N	10	16	20	20	20	16	20	20	20	16	20	20
HiBD63H	15	16	20	26	26	16	20	26	26	16	20	26
HiBD125	15	16	20	26	26	16	20	26	26	16	20	26

Upstream	HGM30		HGM50				HGM60				HGM100			
	E	S	E	S	H	L	E	S	H	L	E	S	H	L
Breaking capacity [Icu] (kA r.m.s.)	16	20	16	20	38	55	16	20	26	30	16	20	26	30
Downstream breaking capacity [Icu] (kA r.m.s.)	Enhanced breaking capacity													
HGM30E	16	20		20	26	30		20	20	20		20	20	20
HGM30S	20				30	30			26	26			26	26
HGM50E	16			20	26	30		20	20	20		20	20	20
HGM50S	20				30	38			26	26			26	26
HGM50H	38					55								
HGM60E	16							20	20	20		20	20	20
HGM60S	20								26	26			26	26
HGM60H	26									30				30
HGM100E	16											20	20	20
HGM100S	20												26	26
HGM100H	26													30

Upstream	HGM125				HGM160				HGM250				HGM400				
	E	S	H	L	E	S	H	L	E	S	H	L	E	S	H	L	
Breaking capacity [Icu] (kA r.m.s.)	20	26	38	55	20	26	38	55	20	26	38	55	38	50	70	85	
Downstream breaking capacity [Icu] (kA r.m.s.)	Enhanced breaking capacity																
HGM30E	16	20	26	26	30	20	26	26	30	20	26	26	30	26	26	30	30
HGM30S	20		26	30	30		26	30	30		26	30	30		30	30	30
HGM50E	16	20	26	26	30	20	26	30	30	20	26	30	30	20	26	30	30
HGM50S	20		26	30	38		26	30	38		26	30	38	20	30	38	38
HGM50H	38				55								55		50	70	70
HGM50L	55															70	70
HGM60E	16	20	26	26	30	20	26	26	30	20	26	26	30	26	26	30	30
HGM60S	20		26	30	30		26	30	30		26	30	30	26	30	30	30
HGM60H	26			30	38			30	38			30	38	30	38	38	38
HGM60L	30				38				38				38		38	38	38
HGM100E	16	20	26	26	30	20	26	26	30	20	26	26	30	26	26	30	30
HGM100S	20		26	30	30		26	30	30		26	30	30	26	30	30	30
HGM100H	26			30	38			30	38			30	38	30	38	38	38
HGM100L	26				38				38				38		38	38	38

AC440/460 V

Upstream: HGM125, HGM160, HGM250, HGM400, HGM630, HGM800

Downstream: HGM100, HGM160, HGM250, HGM400, HGM630, HGM800

Upstream	HGM125				HGM160				HGM250				HGM400			
	E	S	H	L	E	S	H	L	E	S	H	L	E	S	H	L
Breaking capacity [Icu] (kA r.m.s.)	20	26	38	55	20	26	38	55	20	26	38	55	38	50	70	85
Downstream breaking capacity [Icu] (kA r.m.s.)	Enhanced breaking capacity															
HGM125E	20	26	30	38		26	30	38		26	30	38	26	30	38	38
HGM125S	26		38	38			38	38			38	38		38	50	50
HGM125H	38			55				55				55		50	70	70
HGM125L	55														70	70
HGM160E	20					26	30	38		26	30	38	26	30	38	38
HGM160S	26						38	50			38	50	30	38	50	50
HGM160H	38							55				55		50	70	70
HGM160L	55														70	70

Upstream	HGM250				HGM400				HGM630				HGM800			
	E	S	H	L	E	S	H	L	E	S	H	L	S	H	L	
Breaking capacity [Icu] (kA r.m.s.)	20	26	38	55	38	50	70	85	38	50	70	85	50	70	85	
Downstream breaking capacity [Icu] (kA r.m.s.)	Enhanced breaking capacity															
HGM250E	20	26	30	38	26	30	38	38	26	30	38	38	30	38	38	
HGM250S	26		38	50	30	38	50	50	30	38	50	50	38	50	50	
HGM250H	38			55		50	70	70		50	70	70	50	70	70	
HGM250L	55						70	70			70	70			70	
HGM400E	38					50	70	70		50	70	70	50	70	70	
HGM400S	50						70	85			70	85		70	85	
HGM400H	70							85				85			85	
HGM630E	38									50	70	70	50	70	70	
HGM630S	50										70	85		70	85	
HGM630H	70											85			85	
HGM800S	50													70	85	
HGM800H	70														85	

Technical Information

Installation

Insulation Distance

When installing a circuit breaker, safety clearances must be kept among the breakers, panels, busbars and other protection devices installed nearby. When a short circuit interruption occurs, high temperature gas occurs and the gas is expelled above the arc chambers of the circuit breaker. In order to allow the gas to be distributed and to prevent fire and arcing or short-circuit currents, safety clearances are required.

The separation distance in the case the circuit breaker is installed side by side.

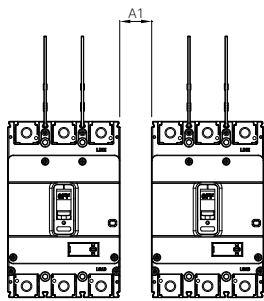

※ Using minimum separation distance (A=0), you should assemble terminal cover and phase barrier between the product.

In the case of iron panels, the distance between the upper and base side or the right and left side.

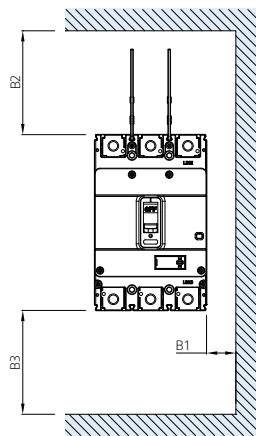

In the case of iron panels, the distance between the front and back.

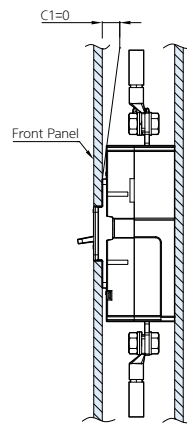

In the case that the live part is exposed, the distance from the circuit breaker.

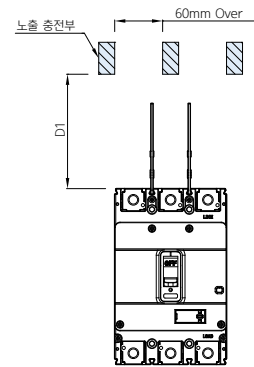

※ If the distance of both conductors is less than 60mm, please insulate the charging part.

HGM/HGE Type's Minimum Insulation Distance.

Type	Minimum Clearance (mm)											
	460V						240V					
	A1	B1	B2	B3	C1	D1	A	B1	B2	B3	C1	D1
HGM30 E/S	0	25	50	25	0	85	0	15	50	25	0	70
HGM50 E/S	0	25	50	25	0	85	0	15	50	25	0	70
HGM100 E/S/H/L	0	25	50	25	0	85	0	15	50	25	0	70
HGM50 H/L	0	25	50	25	0	85	0	15	50	25	0	70
HGM125 E/S/H/L	0	25	50	25	0	85	0	15	50	25	0	70
HGM160 E/S	0	25	80	40	0	140	0	15	80	40	0	110
HGM160 H/L	0	40	80	40	0	140	0	20	80	40	0	110
HGM250 E/S	0	25	80	40	0	140	0	15	80	40	0	110
HGM250 H/L	0	40	80	40	0	140	0	20	80	40	0	110
HGE30 E/S	0	25	50	25	0	85	0	15	50	25	0	70
HGE50 E/S	0	25	50	25	0	85	0	15	50	25	0	70
HGE100 E/S/H/L	0	25	50	25	0	85	0	15	50	25	0	70
HGE50 H/L	0	25	50	25	0	85	0	15	50	25	0	70
HGE125 E/S/H/L	0	25	50	25	0	85	0	15	50	25	0	70
HGE160 E/S	0	25	80	40	0	140	0	15	80	40	0	110
HGE160 H/L	0	40	80	40	0	140	0	20	80	40	0	110
HGE250 E/S	0	25	80	40	0	140	0	15	80	40	0	110
HGE250 H/L	0	40	80	40	0	140	0	20	80	40	0	110
HGM400 E/S	0	60	120	60	0	200	0	30	120	60	0	160
HGM400 H/L	0	80	120	60	0	200	0	40	120	60	0	160
HGM630, 800 E/S	0	60	120	60	0	200	0	30	120	60	0	160
HGM630, 800 H/L	0	80	120	60	0	200	0	40	120	60	0	160
HGE400 E/S	0	60	120	60	0	200	0	30	120	60	0	160
HGE400 H/L	0	80	120	60	0	200	0	40	120	60	0	160
HGE630, 800 E/S	0	60	120	60	0	200	0	30	120	60	0	160
HGE630, 800 H/L	0	80	120	60	0	200	0	40	120	60	0	160

Installation Angle

The HGM circuit breakers can be installed vertically or horizontally without changing any characteristics. Please refer to detail installation direction shown in the figure below.

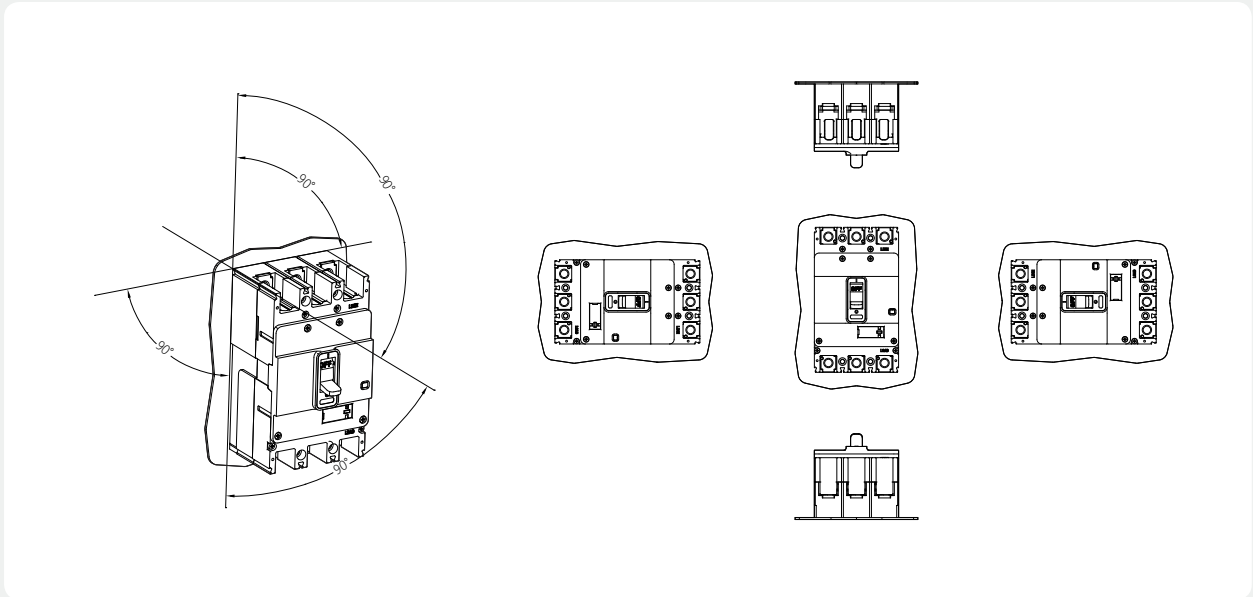

Direction of Power Supply

HGM/HGE Type

Please confirm LINE/LOAD mark at circuit breaker's front cover before connecting terminal wire.

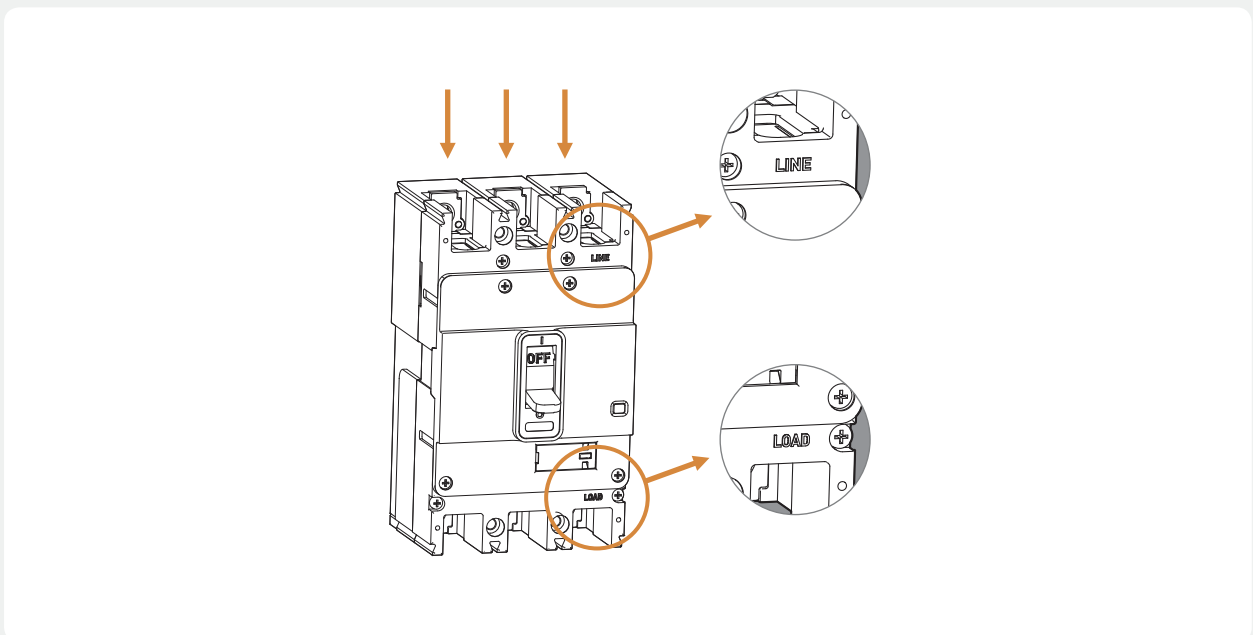





Technical Information

Standard Configuration

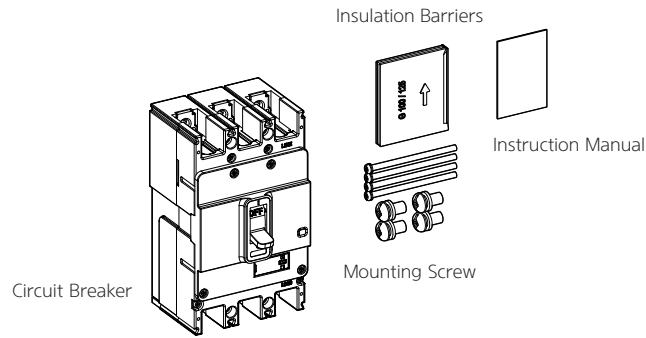
HGM/HGE Type





HGM/HGE30 - 250

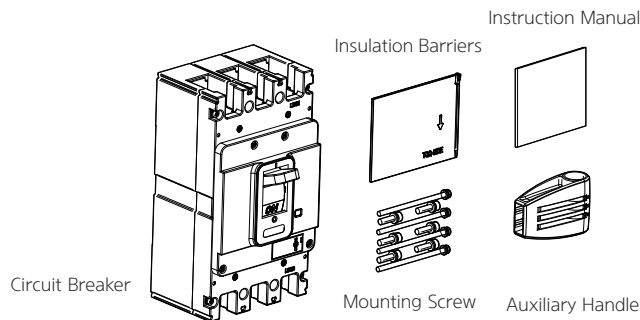

Type	Part					
HGM/HGE 30, 50E/S, 60, 100	2P	2 EA (M4 x L70)	4 EA	(M5 x L15) (15 - 50 A)	(M8 x L15) (60 - 100 A)	1 EA
	3P	4 EA (M4 x L70)	6 EA			2 EA
	4P	6 EA (M4 x L70)	8 EA			3 EA
HGM/HGE 50H/L, 125	2P	2 EA (M4 x L70)	4 EA (M8 x L15)		1 EA	
	3P	4 EA (M4 x L70)	6 EA (M8 x L15)		2 EA	
	4P	6 EA (M4 x L70)	8 EA (M8 x L15)		3 EA	
HGM/HGE 160, 250	2P	4 EA (M4 x L70)	4 EA (Hex socket M8 x L15)		1 EA	
	3P	4 EA (M4 x L70)	6 EA (Hex socket M8 x L15)		2 EA	
	4P	6 EA (M4 x L70)	8 EA (Hex socket M8 x L15)		3 EA	

HGM/HGE400 - 800



Type	Part				
HGM/HGE 400	2P	4 EA (M6 x L103)	4 EA (M10 x L30)	1 EA	1 EA
	3P	4 EA (M6 x L103)	6 EA (M10 x L30)	2 EA	1 EA
	4P	6 EA (M6 x L103)	8 EA (M10 x L30)	3 EA	1 EA
HGM/HGE 630, 800	2P	4 EA (M6 x L103)	4 EA (M12 x L30)	1 EA	1 EA
	3P	4 EA (M6 x L103)	6 EA (M12 x L30)	2 EA	1 EA
	4P	6 EA (M6 x L103)	8 EA (M12 x L30)	3 EA	1 EA

MCCB/ELCB Assembly and Terminal Mounting Specification

HGM/HGE Type

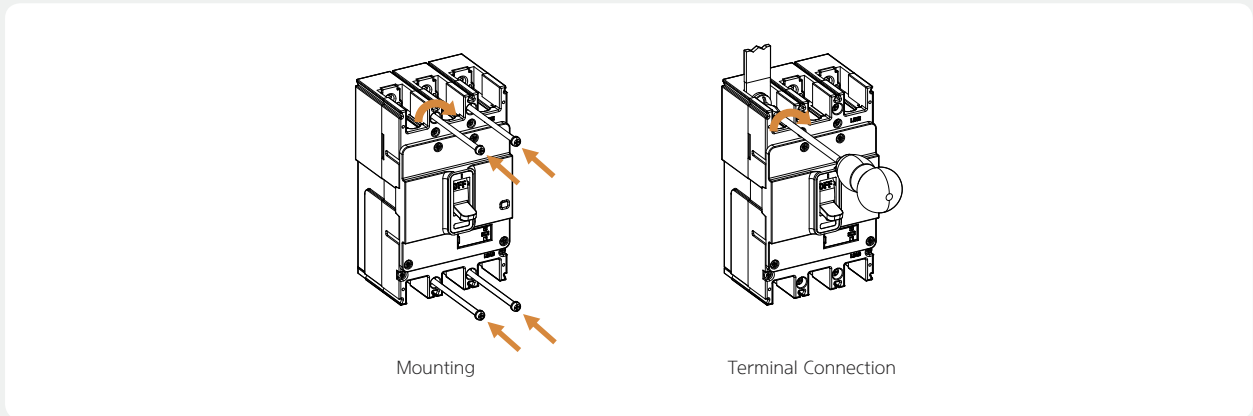

No	Type	Panel Mounting		Connection Terminal		
		Screw	Terminal (mm)	Screwing Torque	Conductor	Mounting Torque
1	HGM/HGE 30, 50E/S, 60, 100	M4: 13 kgf.cm		 M5 x L15 (≤50) M8 x L15 (>50)		M5: 28.5 kgf.cm M8: 110 kgf.cm
2	HGM/HGE 50H/L,125	M4: 13 kgf.cm		 M8 x L15		M8: 110 kgf.cm
3	HGM/HGE 160, 250	M4: 13 kgf.cm		 Hex Socket Bolt M8 x L15		Hex M8: 110 kgf.cm
4	HGM/HGE 400	M6: 45 kgf.cm		 Hex Socket Bolt M10 x L30		Hex M10: 270 kgf.cm
5	HGM/HGE 630, 800	M6: 45 kgf.cm		 Hex Socket Bolt M12 x L30		Hex M12: 470 kgf.cm

Characteristic Curves & Dimensions

Characteristic Curves

Operation Characteristic Curve	70
Current & Energy-Limiting Characteristic Curve	75

Dimensions

Front Connection Type	76
Rear Connection Type	86
Plug-In Type	91
Rotary Handle	102
Mechanical Interlock	107
Terminal Cover	112
Motor Operator	115
Lug Terminal	117
DIN Rail Adaptor	119

Operation Characteristic Curve

HGM/HGE100 (16 - 32 A)

• HGM/HGE30

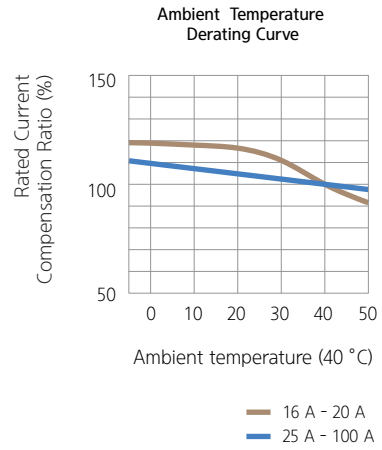
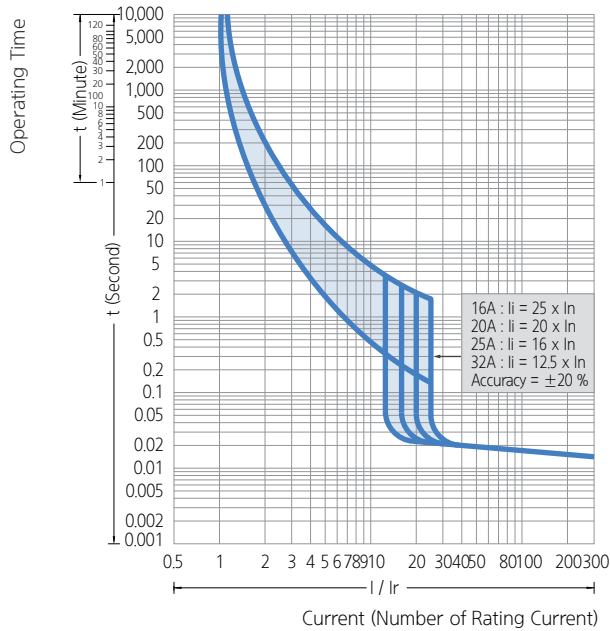

HGM/HGE100 (40 - 100 A)

• HGM/HGE50E/S, 60, 100

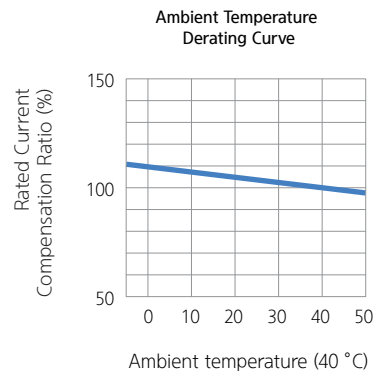
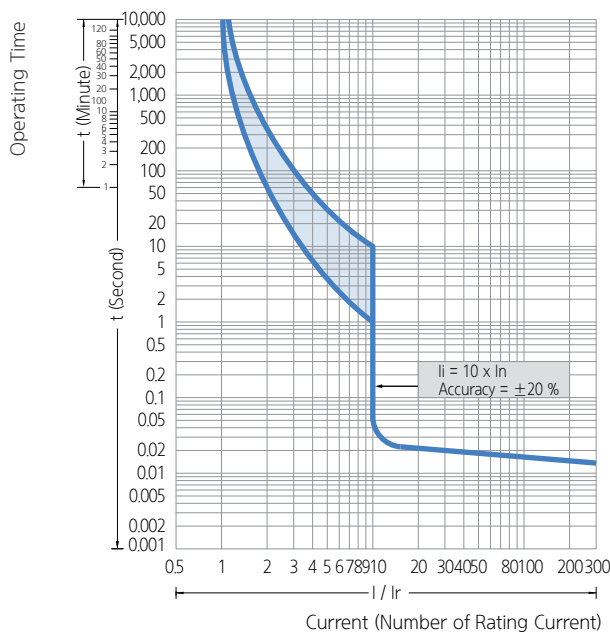

HGM/HGE125 (16 - 32 A)

• HGM/HGE50H/L

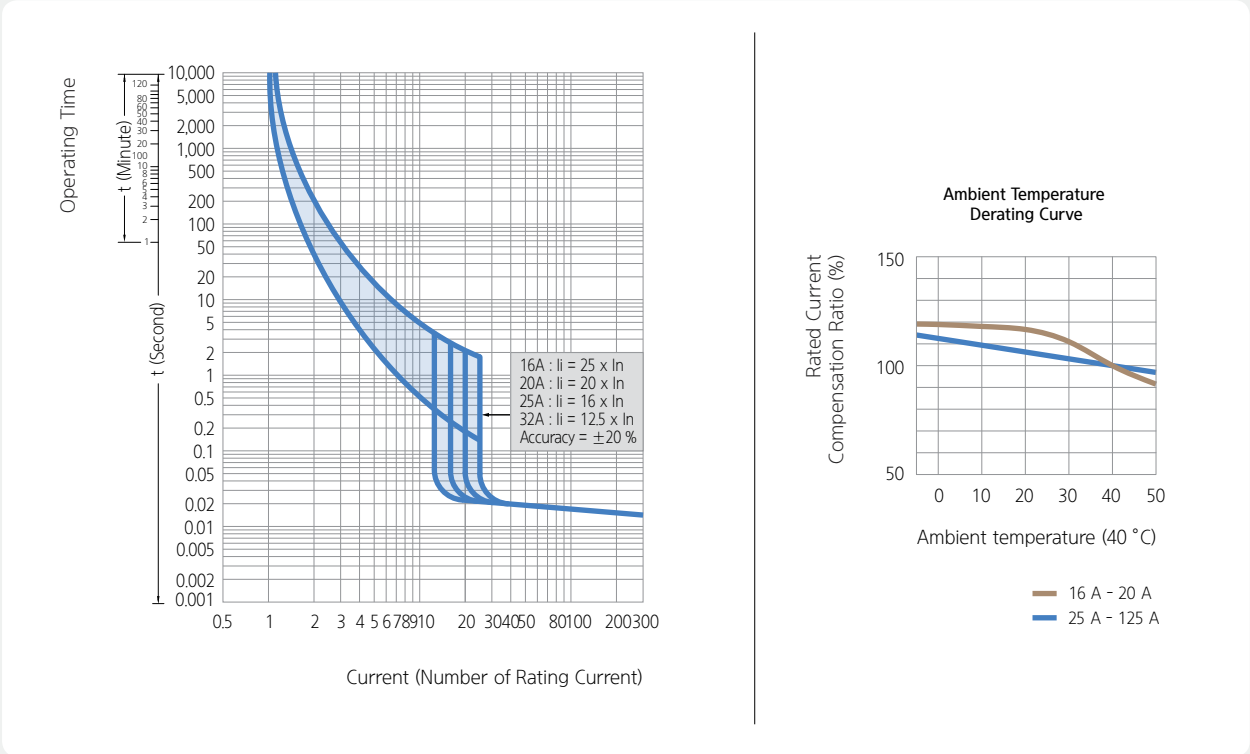

HGM/HGE125 (40 - 125 A)

• HGM/HGE50H/L, 125

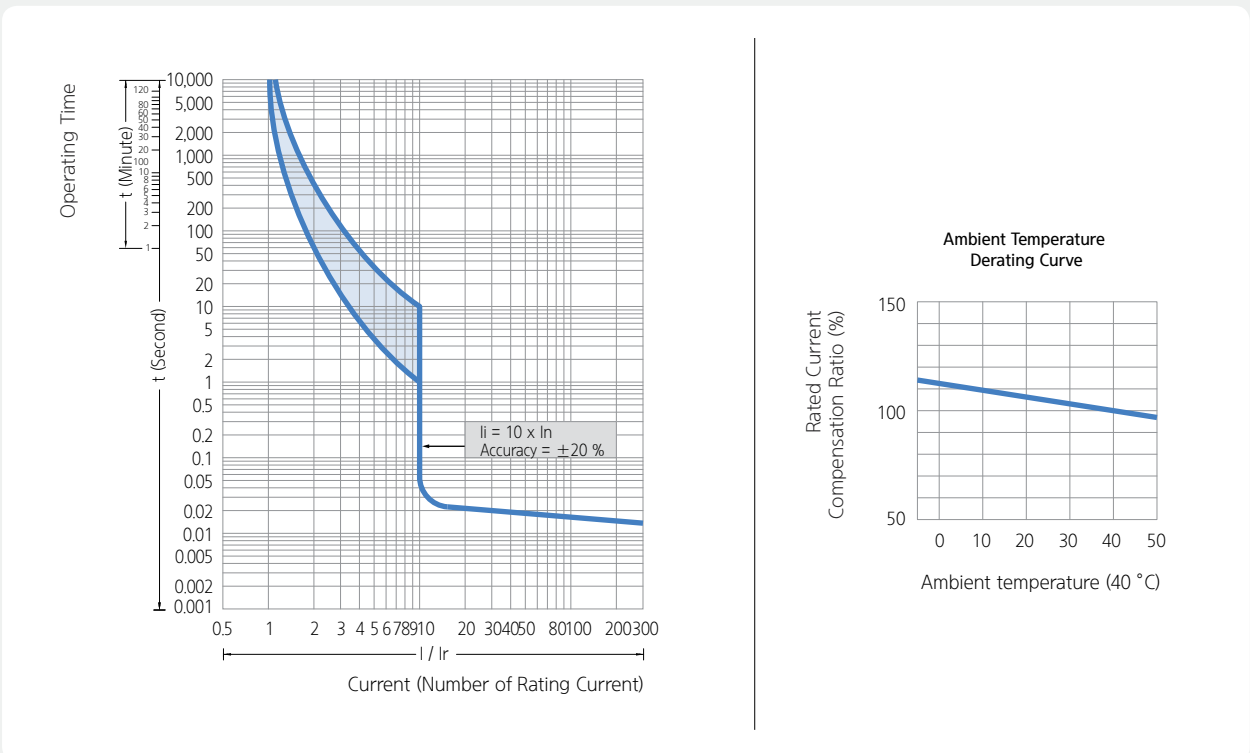

Operation Characteristic Curve

HGM/HGE250 (100 - 250 A)

• HGM/HGE250

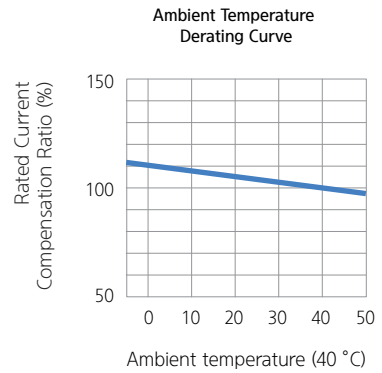
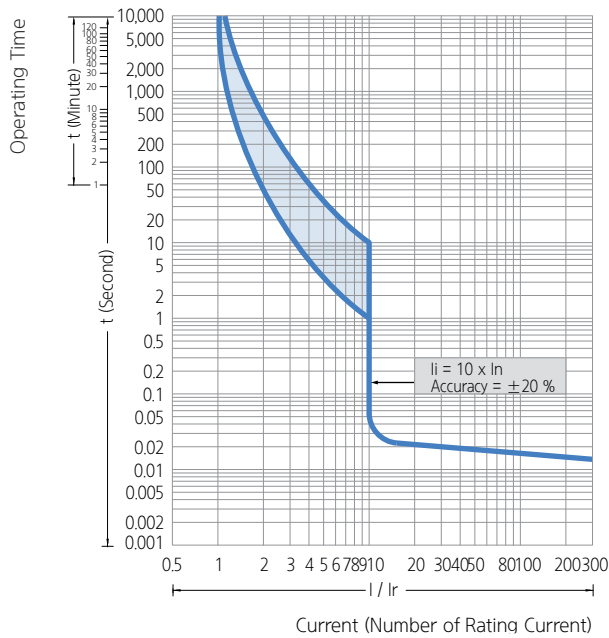

HGM400

• HGM400

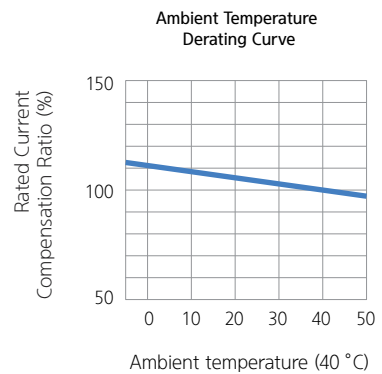
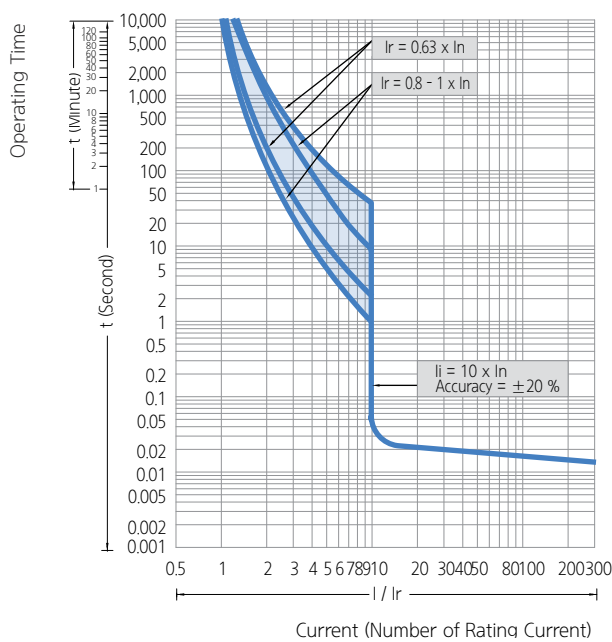

HGM800 (630 - 800 A)

• HGM630, 800

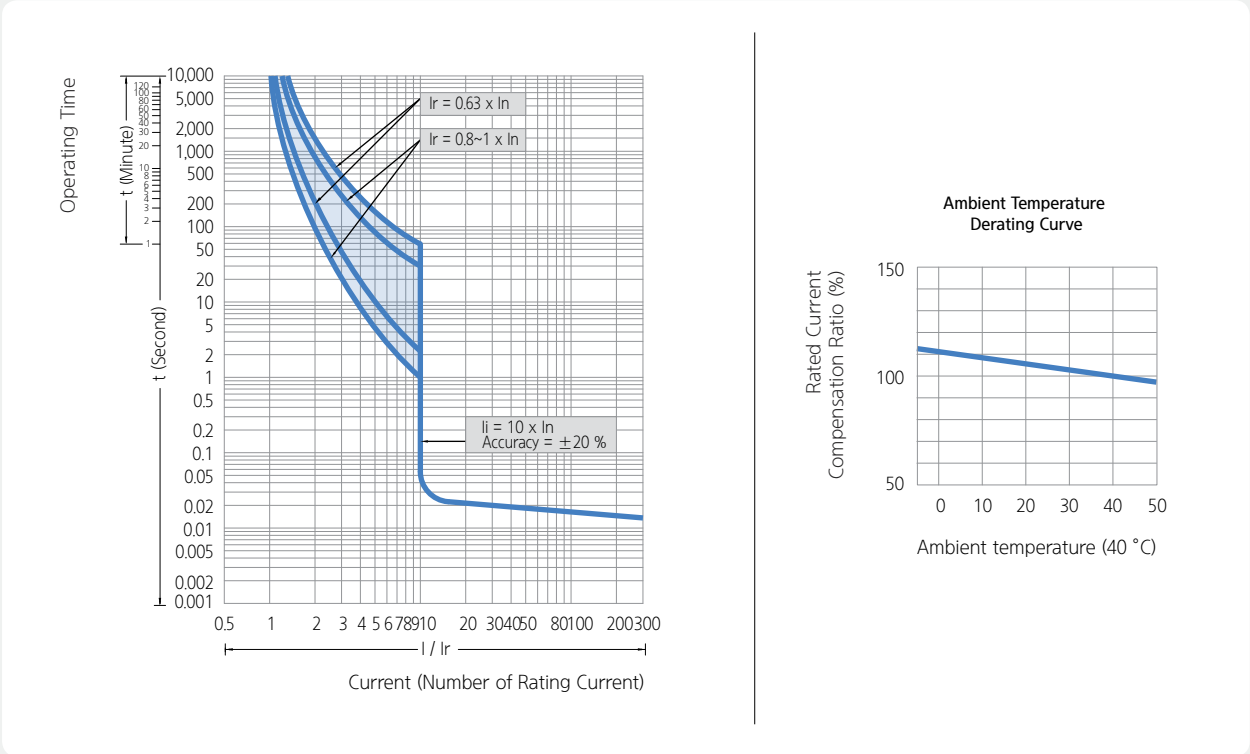

HGE400

• HGE400

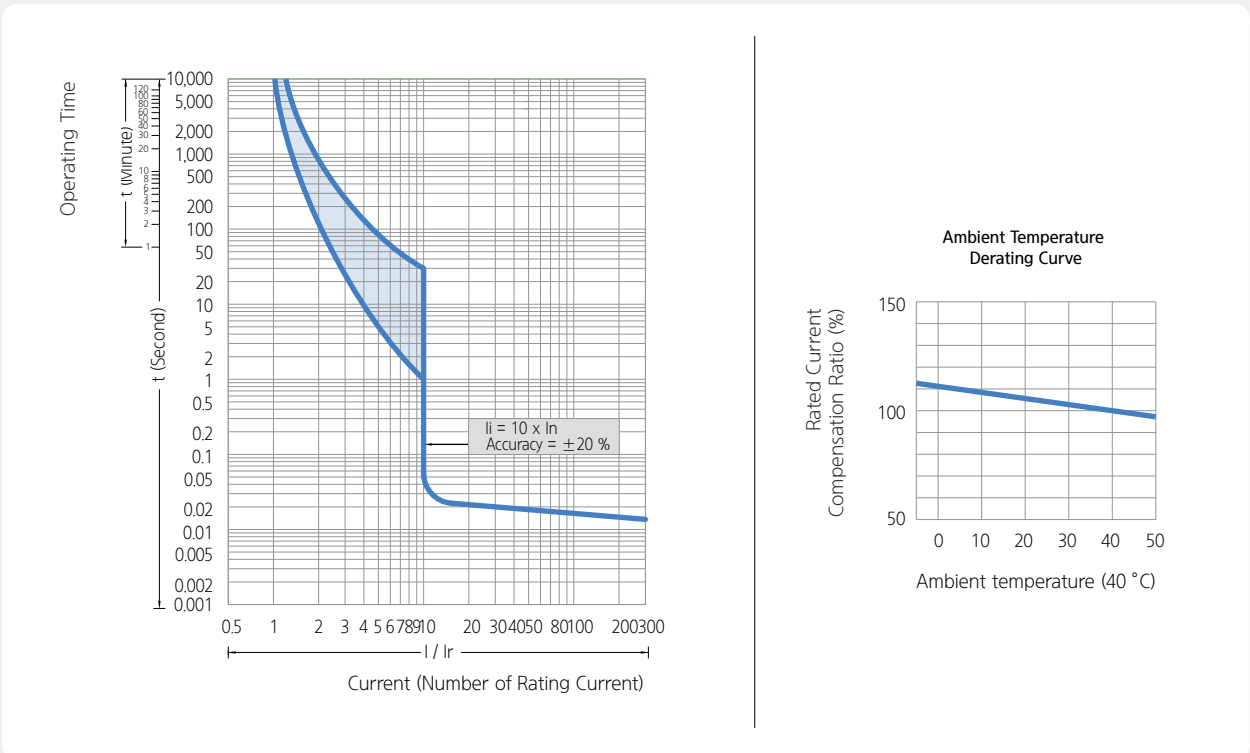

Operation Characteristic Curve

HGE800 (630 - 800A)

• HGE630, 800

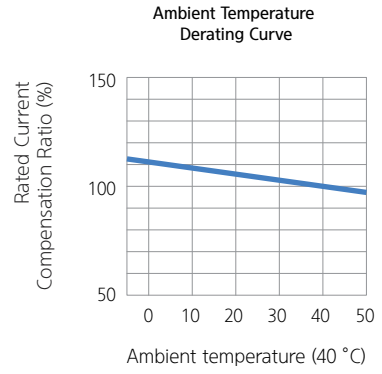
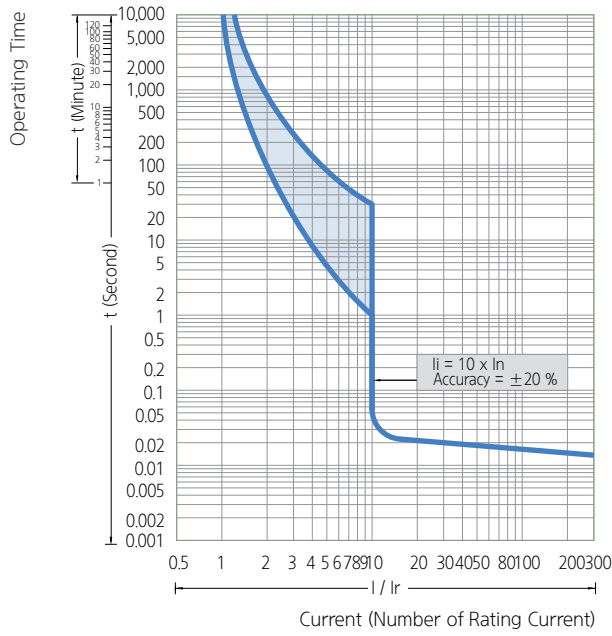

Current & Energy-Limiting Characteristic Curve

Current-Limiting Characteristic Curve

400/460V

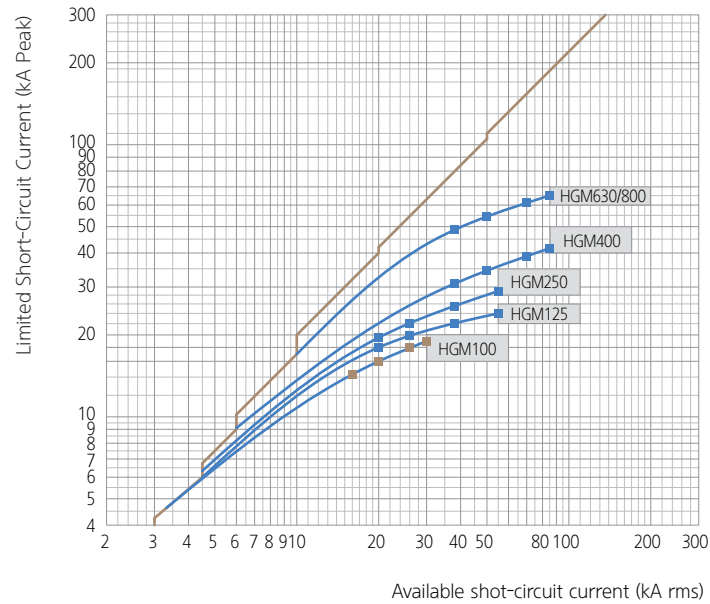

Energy-Limiting Characteristic Curve

400/460V

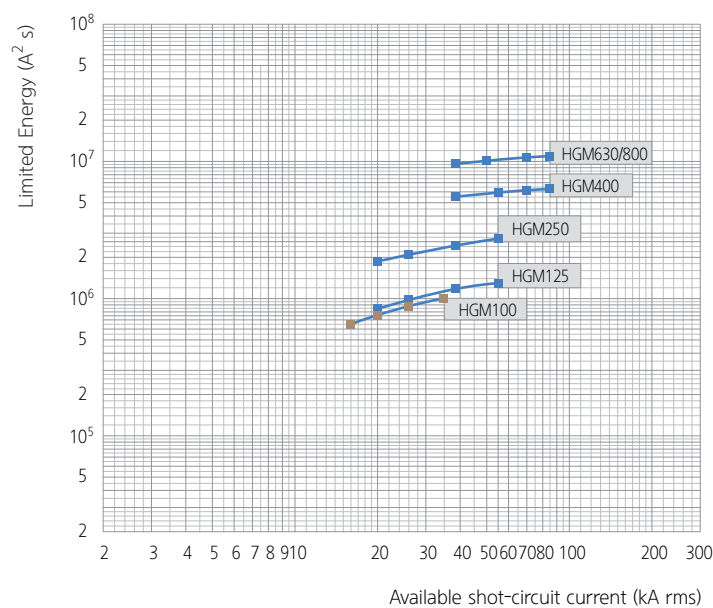

Dimensions

Front Connection Type HGM100

• HGM30, 50E/S, 60, 100

Dimensions

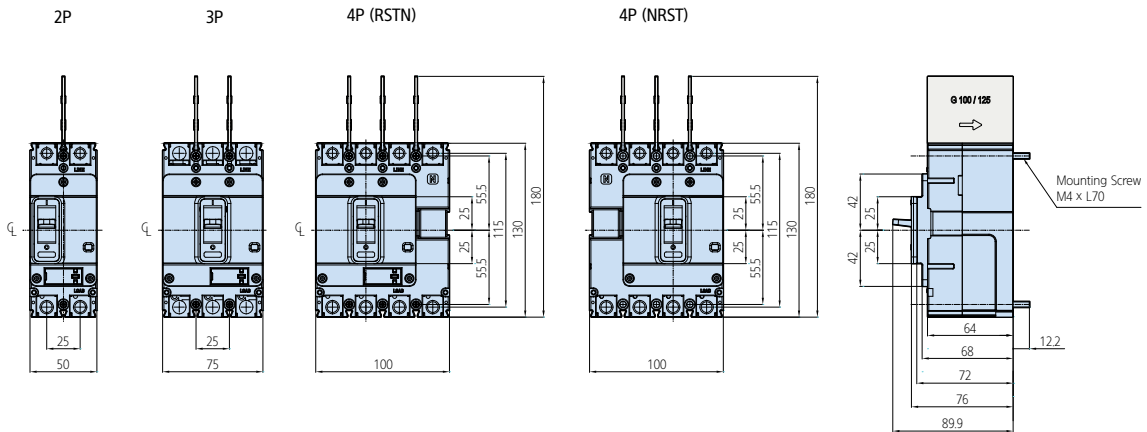

※ Insulation barriers for line side are provided as basic option.

Dimensions for Mounting Body

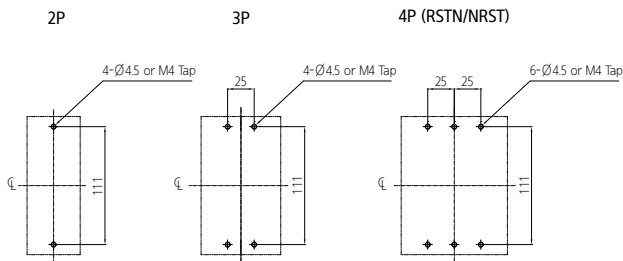

Terminal/Connection Bus Dimension

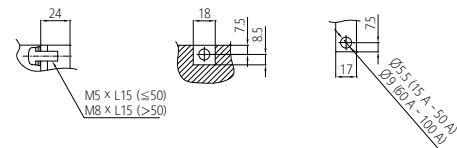

100AF

Specification of Mounting Screw: M4 x L70 P/W
 Specification of Terminal Screw: (Less than 50 A) M5 x L15 P/W P/W
 (Excess than 50 A) M8 x L15 S/W P/W

Panel Cover Cutting Dimensions for Handle

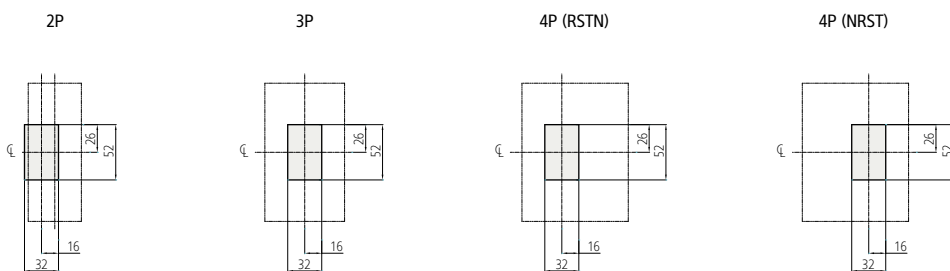

Panel Cover Cutting Dimensions for Handle/Test Button

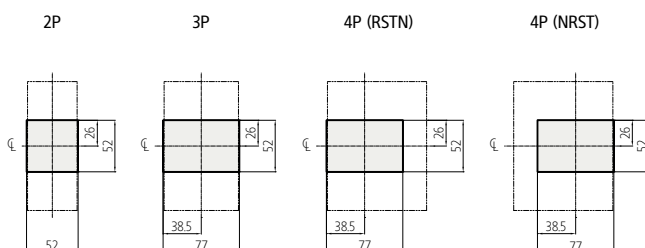

Panel Cover Cutting Dimensions for Handle/Trip Unit

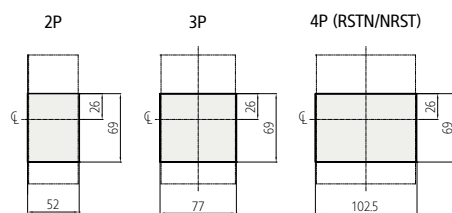

Front Connection Type HGM125

• HGM50H/L, 125

Dimensions

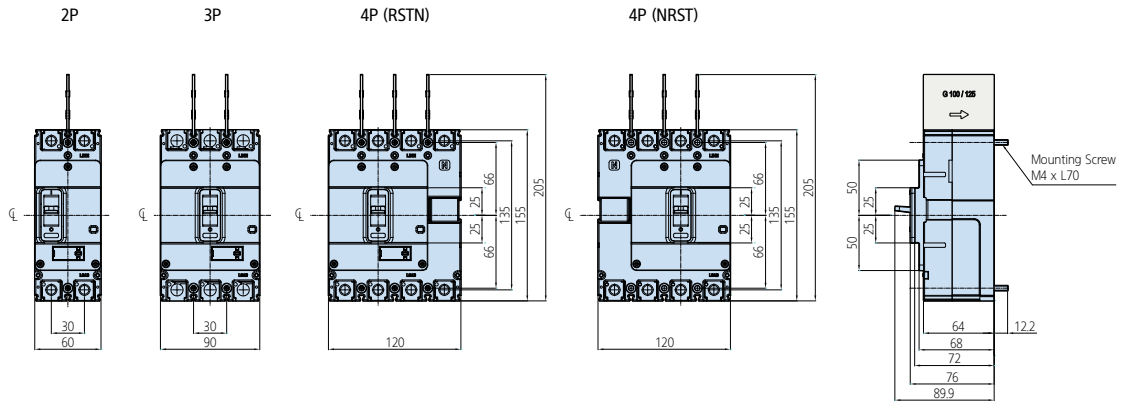

※ Insulation barriers for line side are provided as basic option.

Dimensions for Mounting Body

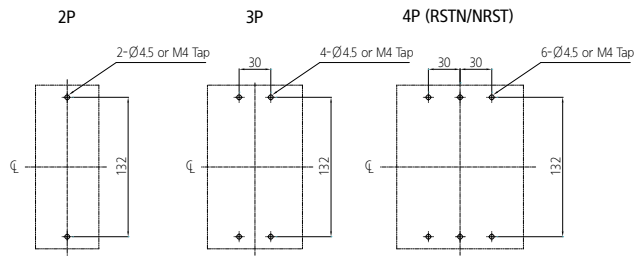

Terminal/Connection Bus Dimension

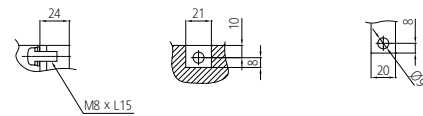

125AF
Specification of Mounting Screw: M4 x L70 P/W
Specification of Terminal Screw: M8 x L15 S/W P/W

Panel Cover Cutting Dimensions for Handle

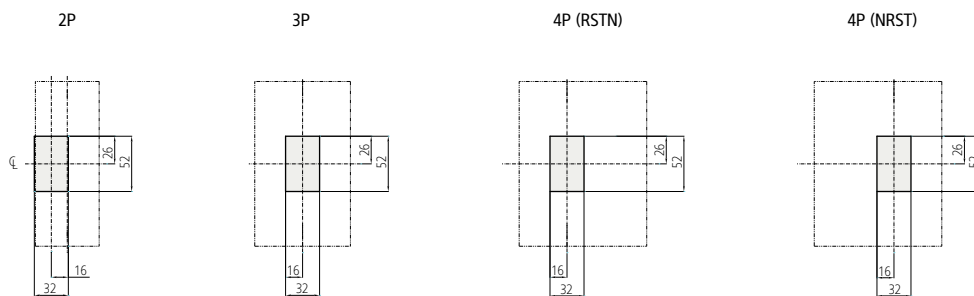

Panel Cover Cutting Dimensions for Handle/Test Button

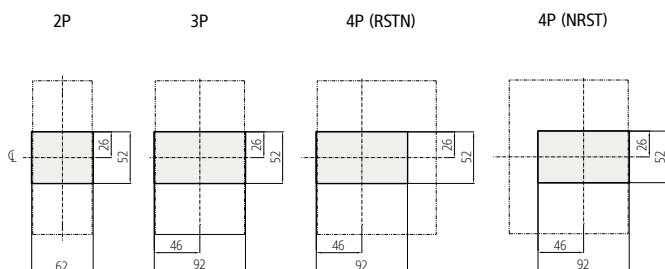

Panel Cover Cutting Dimensions for Handle/Trip Unit

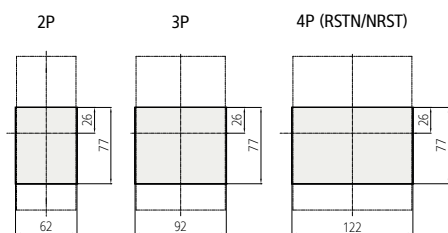

Dimensions

Front Connection Type HGM250

• HGM160, 250

Dimensions

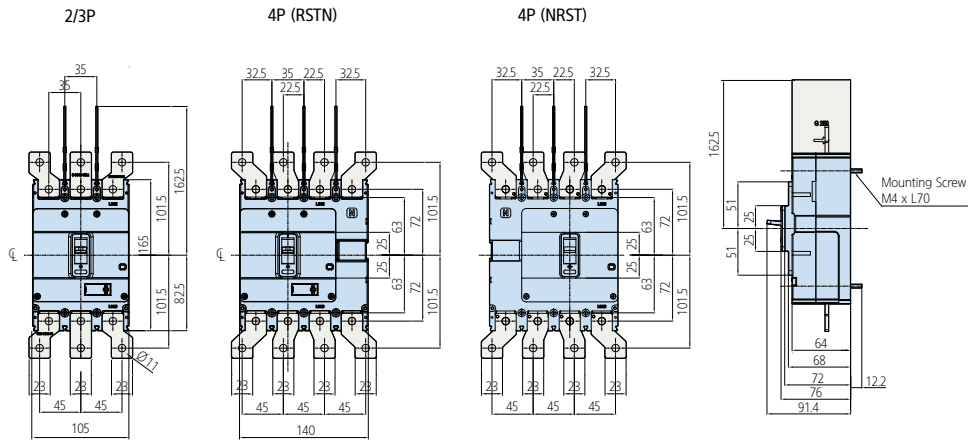

※ Insulation barriers for line side are provided as basic option.

Dimensions for Mounting Body

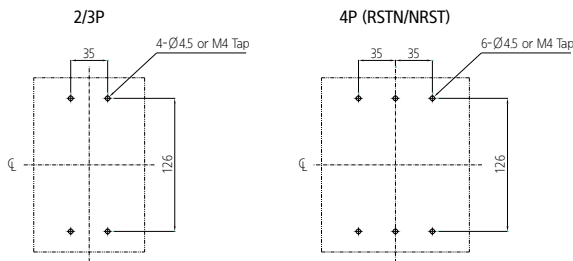

Terminal/Connection Bus Dimension

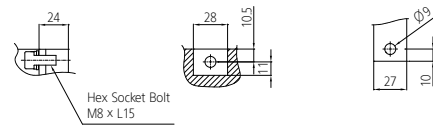

250AF

Specification of Mounting Screw: M4 x L70 P/W
Specification of Terminal Screw: Hex Socket Bolt M8 x L15 S/W P/W

Panel Cover Cutting Dimensions for Handle

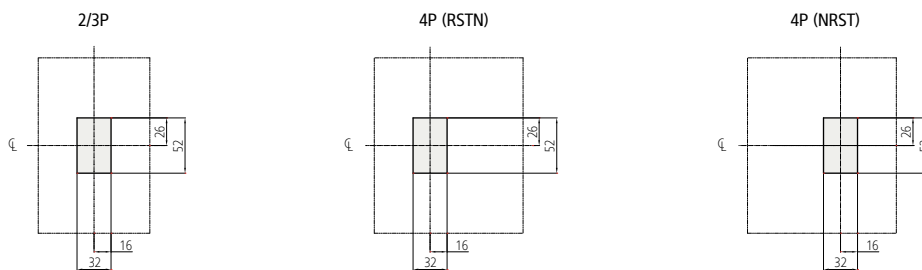

Panel Cover Cutting Dimensions for Handle/Test Button

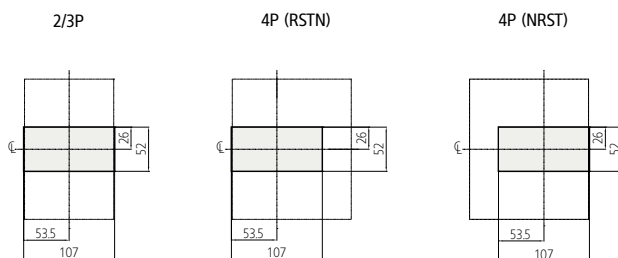

Panel Cover Cutting Dimensions for Handle/Trip Unit

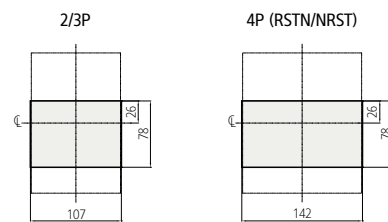

Front Connection Type HGM400

• HGM400

Dimensions

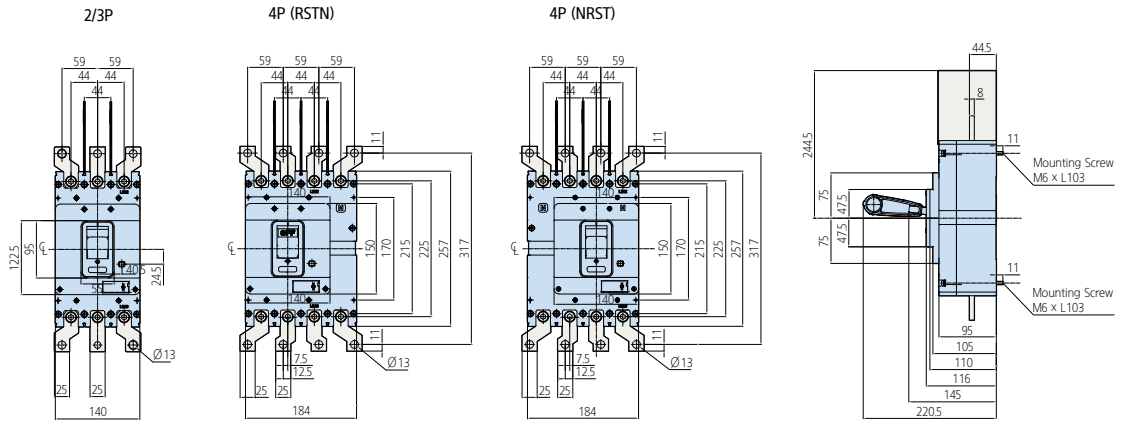

※ Insulation barriers for line side are provided as basic option.

Dimensions for Mounting Body

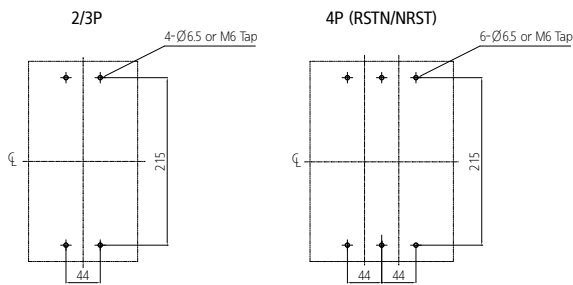

Terminal/Connection Bus Dimension

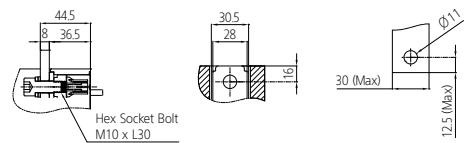

Panel Cover Cutting Dimensions for Handle

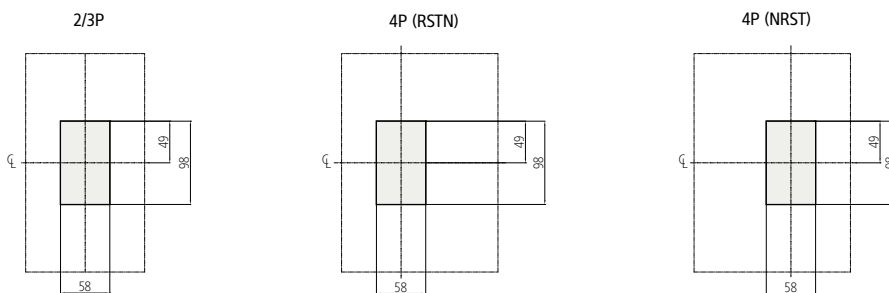

Panel Cover Cutting Dimensions for Handle/Test Button

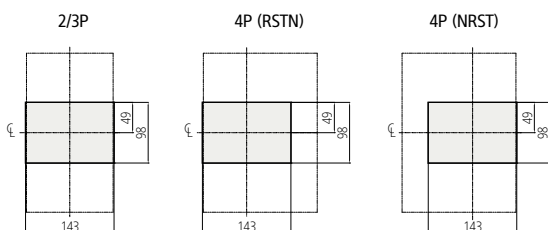

Panel Cover Cutting Dimensions for Handle/Trip Unit

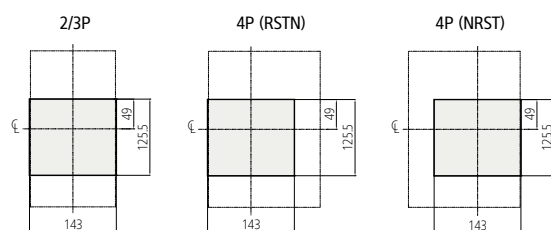

Dimensions

Front Connection Type HGM800

• HGM630, 800

Dimensions

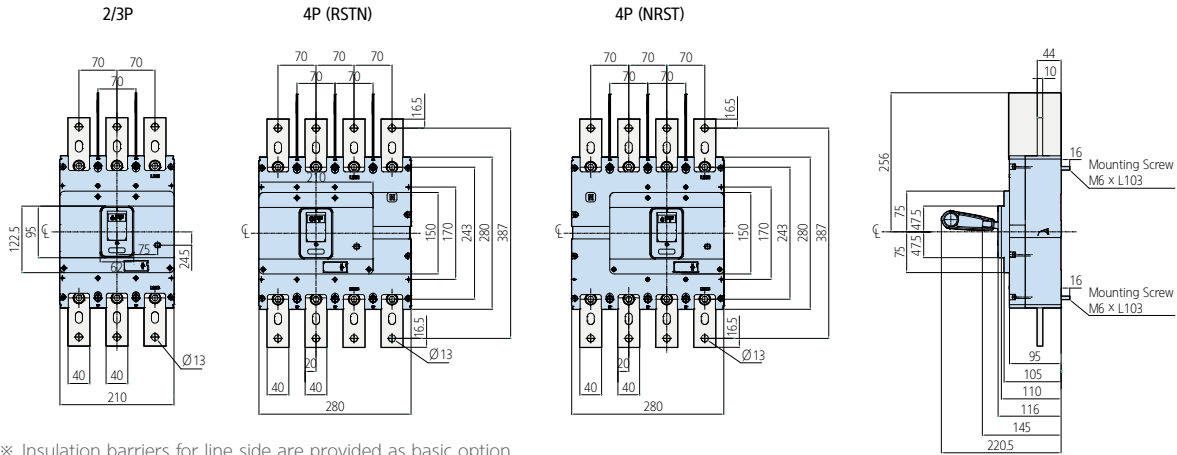

※ Insulation barriers for line side are provided as basic option.

Dimensions for Mounting Body

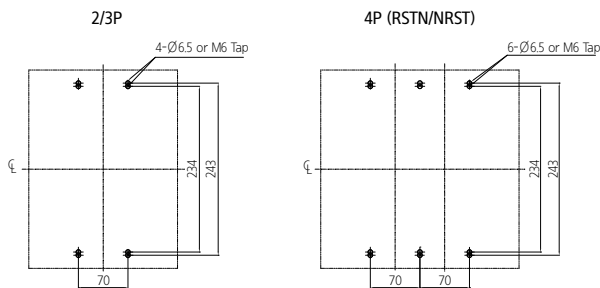

Terminal/Connection Bus Dimension

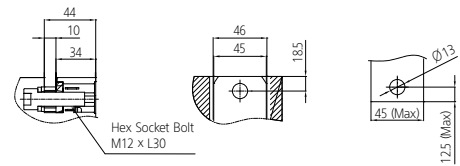

Panel Cover Cutting Dimensions for Handle

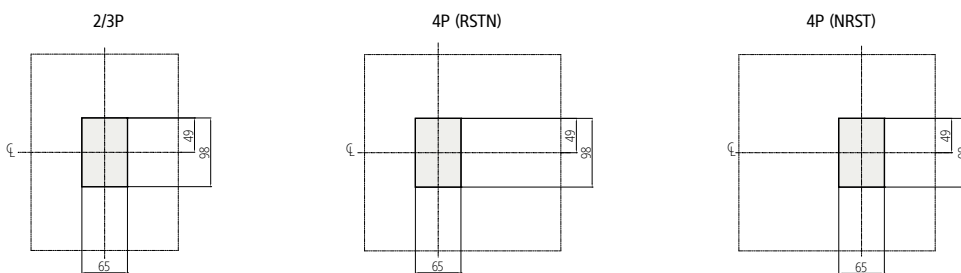

Panel Cover Cutting Dimensions for Handle/Test Button

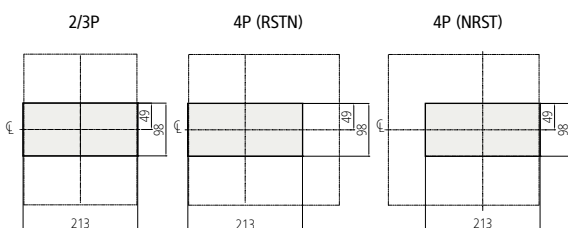

Panel Cover Cutting Dimensions for Handle/Trip Unit

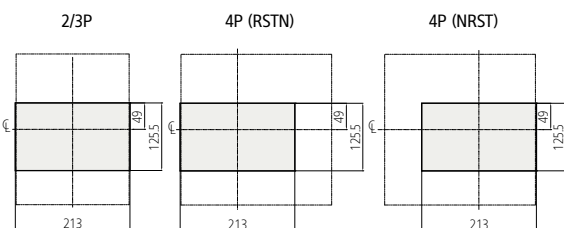

Front Connection Type HGE100

• HGE30, 50E/S, 60, 100

Dimensions

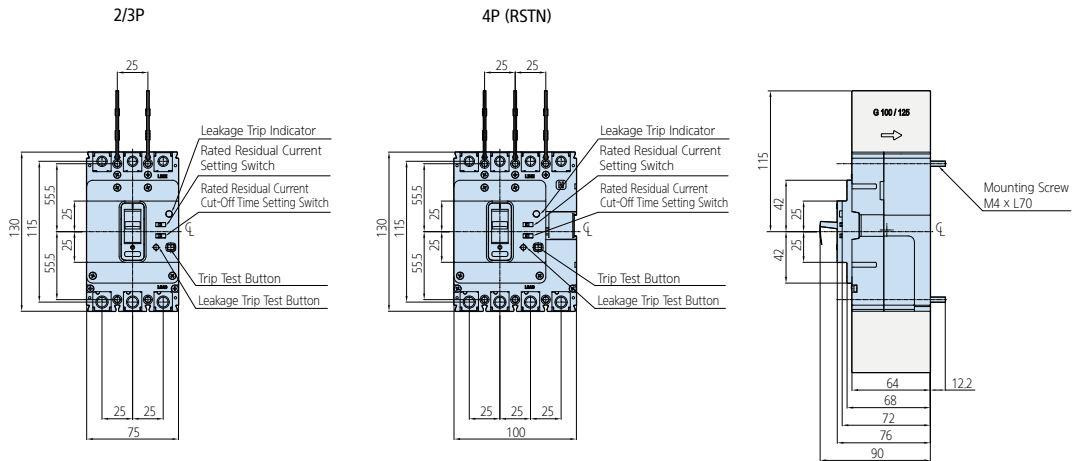

※ Insulation barriers for line side are provided as basic option

Dimensions for Mounting Body

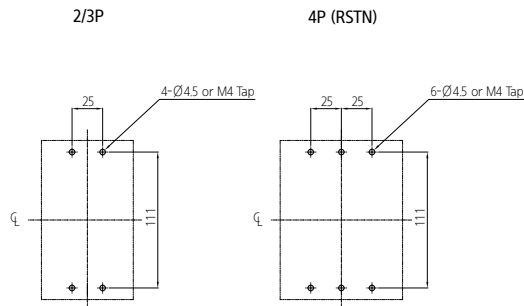

Terminal/Connection Bus Dimension

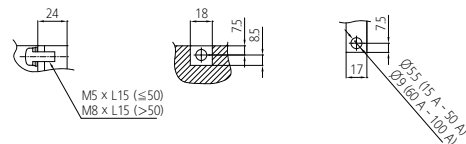

100AF

Specification of Mounting Screw: M4 x L70 PW
 Specification of Terminal Screw: (Less than 50 A) M5 x L15 PW/PW
 (Excess than 50 A) M8 x L15 SW/PW

Panel Cover Cutting Dimensions for Handle

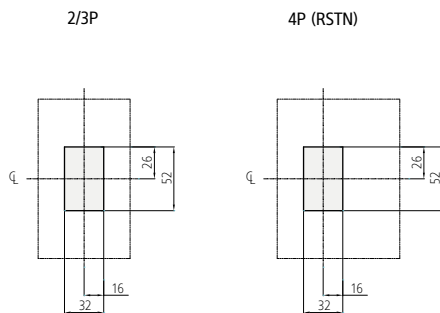

Panel Cover Cutting Dimensions for Handle/Trip Unit

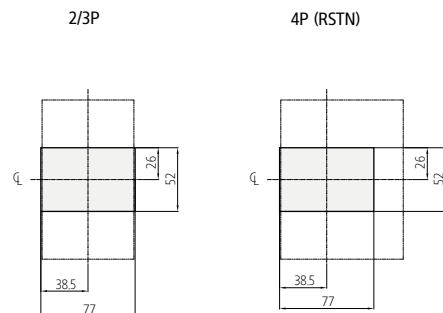

Dimensions

Front Connection Type HGE125

• HGE50H/L, 125

Dimensions

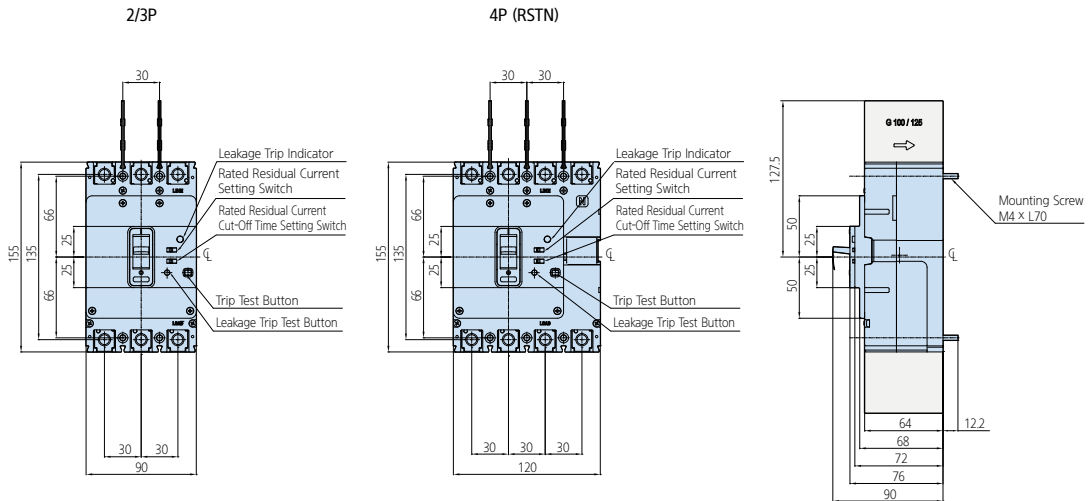

Dimensions for Mounting Body

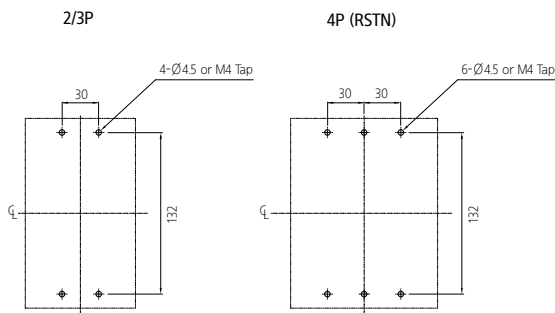

Terminal/Connection Bus Dimension

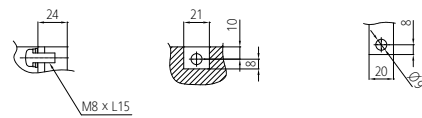

125AF

Specification of Mounting Screw: M4 x L70 P/W
Specification of Terminal Screw: M8 x L15 S/W P/W

Panel Cover Cutting Dimensions for Handle

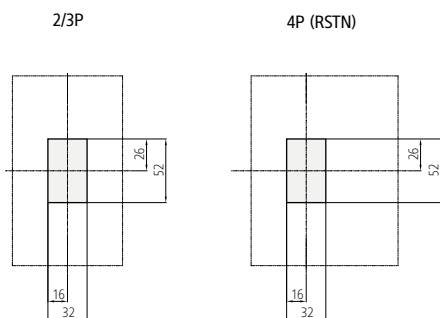

Panel Cover Cutting Dimensions for Handle/Test Button

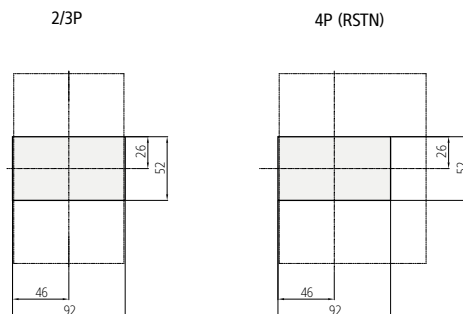

Front Connection Type HGE250

• HGE160, 250

Dimensions

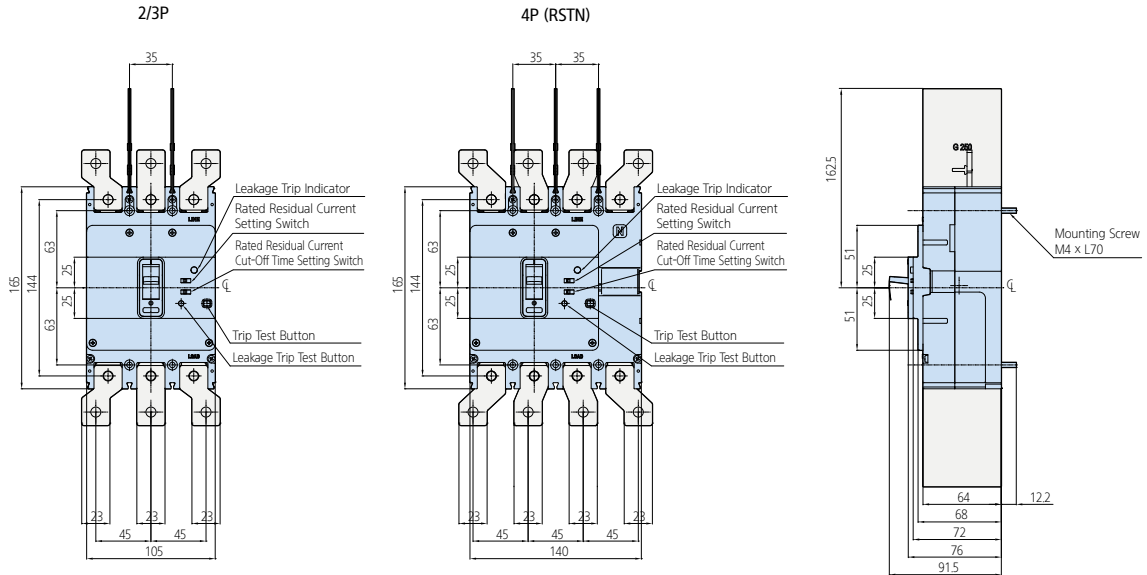

※ Insulation barriers for line side are provided as basic option.

Dimensions for Mounting Body

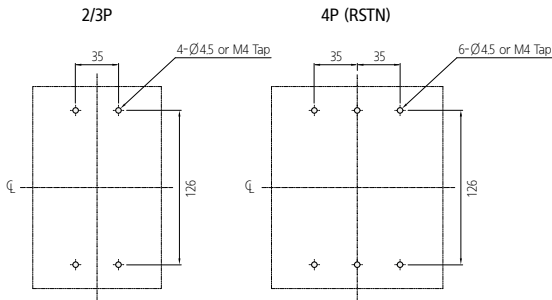

Terminal/Connection Bus Dimension

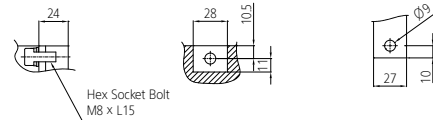

250AF

Specification of Mounting Screw: M4 x L70 P/W

Specification of Terminal Screw: Hex Socket Bolt M8 x L15 S/W P/W

Panel Cover Cutting Dimensions for Handle

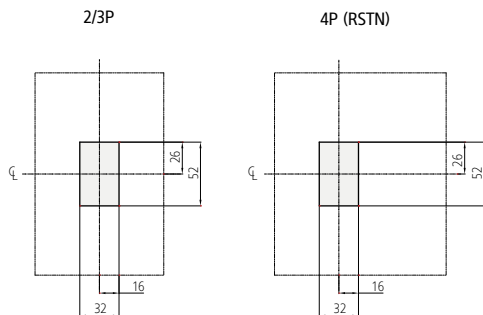

Panel Cover Cutting Dimensions for Handle/Test Button

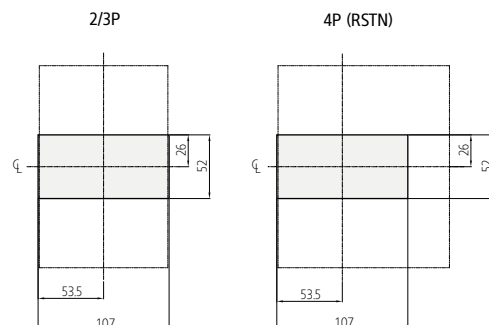

Dimensions

Front Connection Type HGE400

• HGE400

Dimension

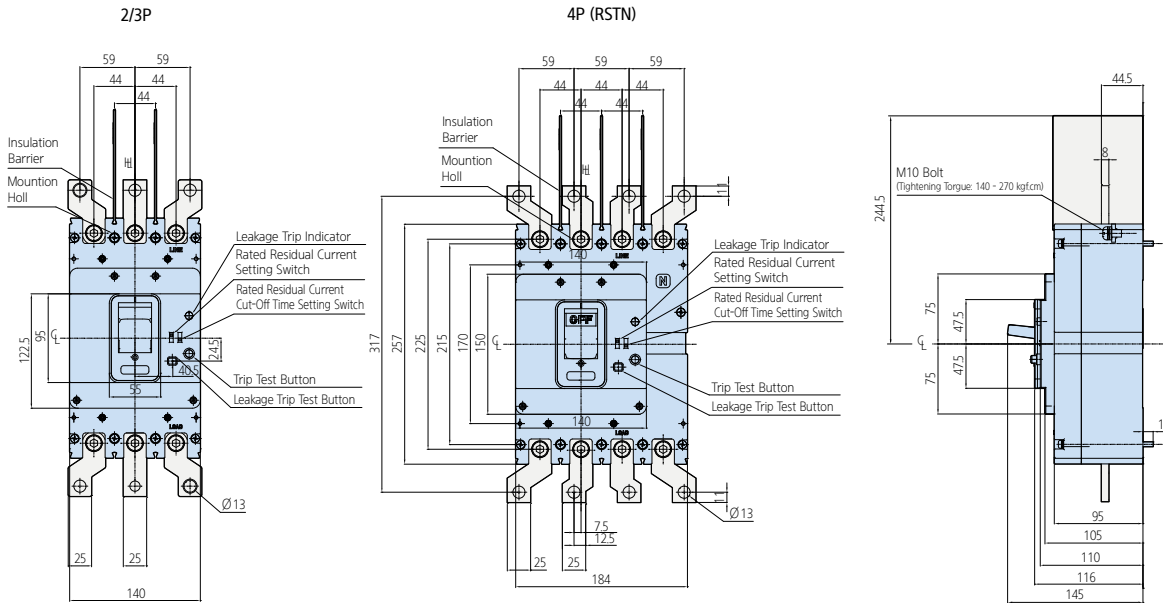

※ Insulation barriers for line side are provided as basic option.

Dimensions for Mounting Body

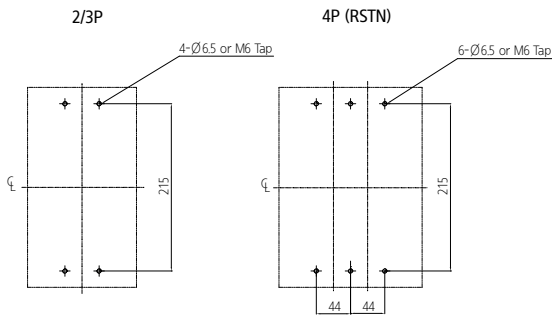

Terminal/Connection Bus Dimension

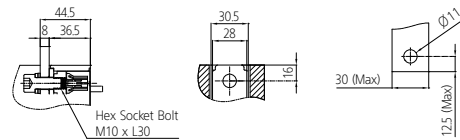

Panel Cover Cutting Dimensions

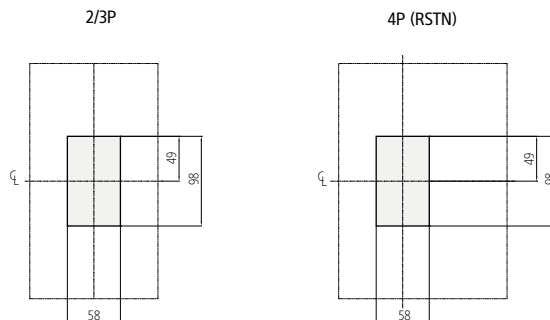

Front Connection Type HGE800

• HGE630, 800

Dimension

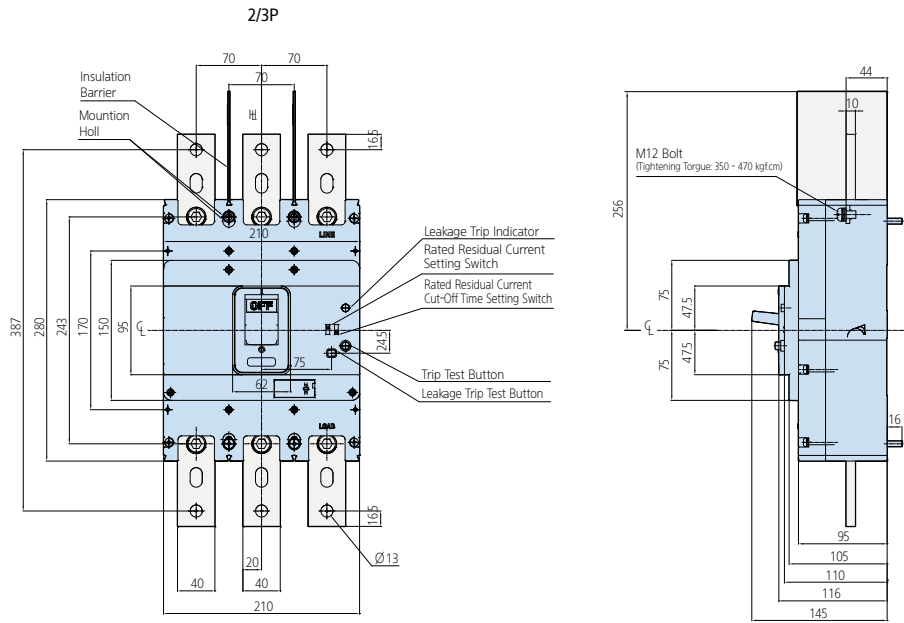

※ Insulation barriers for line side are provided as basic option.

Dimensions for Mounting Body

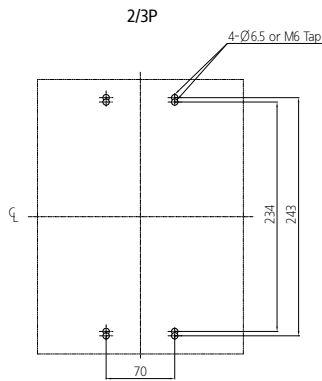

Terminal/Connection Bus Dimension

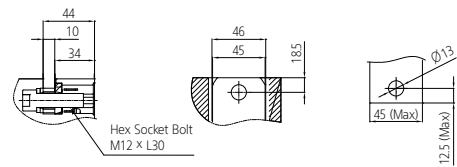

Panel Cover Cutting Dimensions

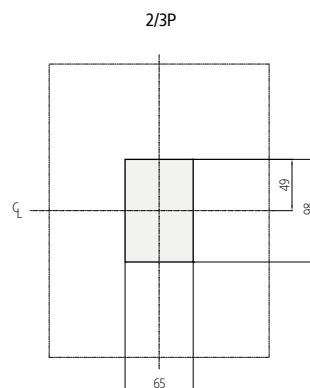

Dimensions

Rear Connection Type HGM100

• HGM30, 50E/S, 60, 100

Dimension

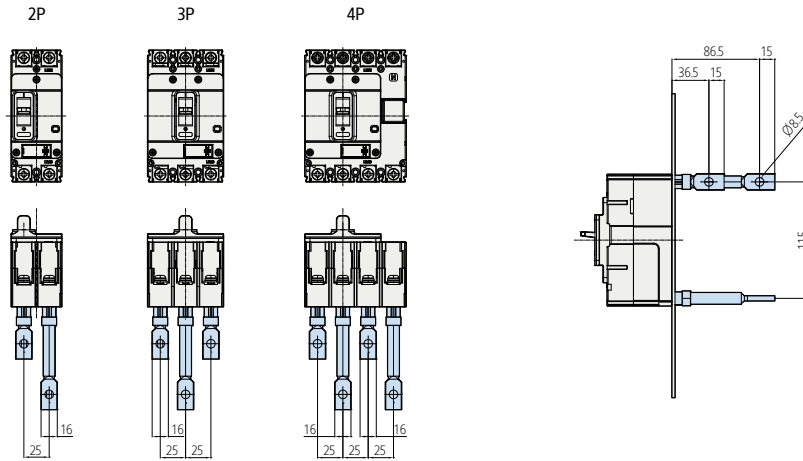

Dimensions for Mounting Body

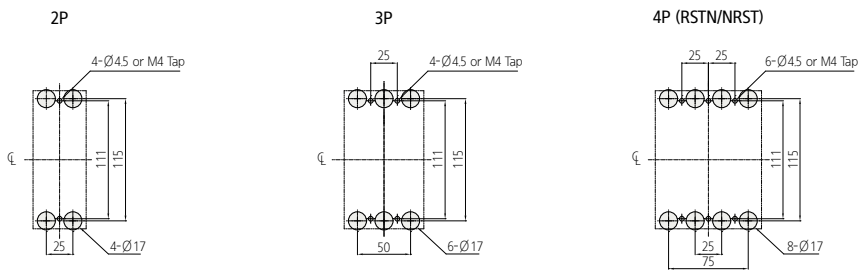

Panel Cover Cutting Dimensions for Handle/Test Button

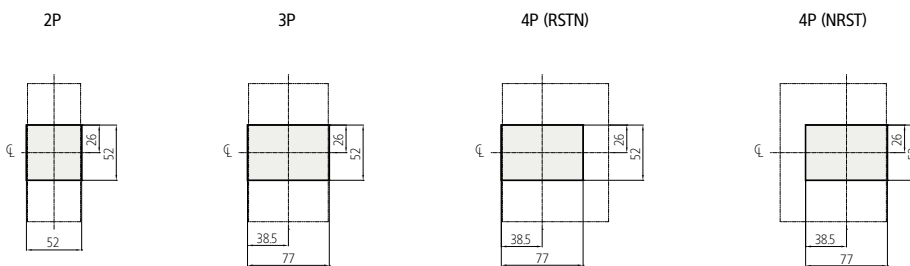

Panel Cover Cutting Dimensions for Handle/Trip Unit

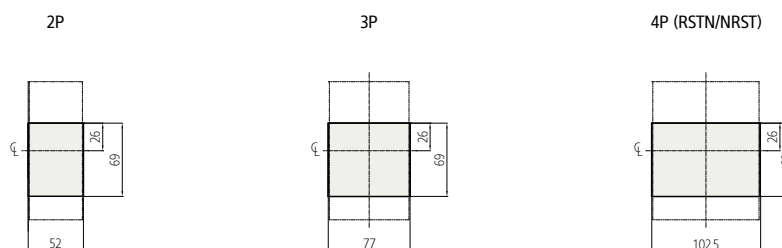

Rear Connection Type HGM125

• HGM50H/L, 125

Dimension

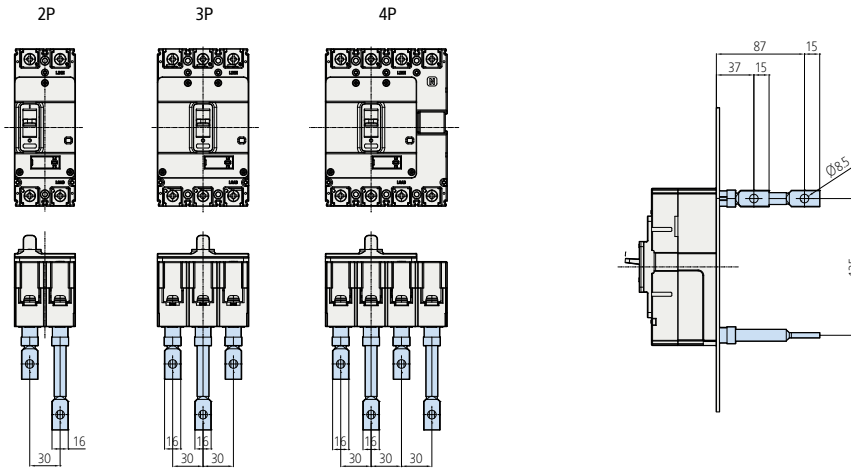

Dimensions for Mounting Body

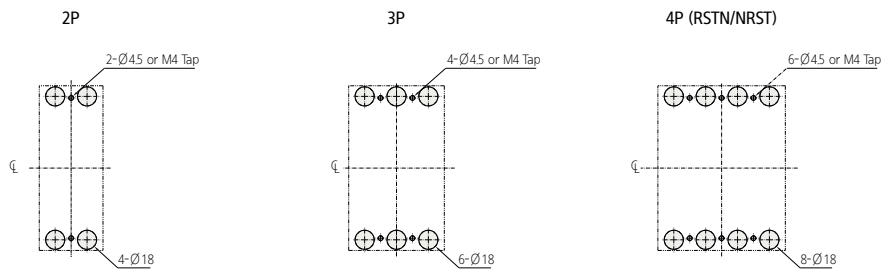

Panel Cover Cutting Dimensions for Handle/Test Button

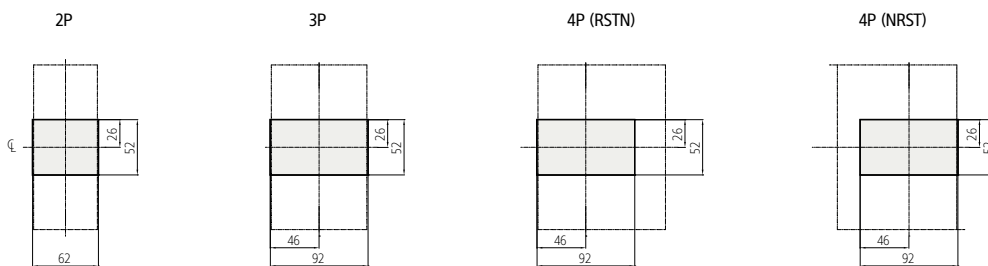

Panel Cover Cutting Dimensions for Handle/Trip Unit

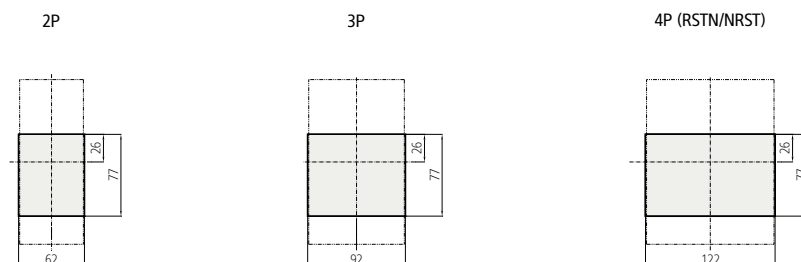

Dimensions

Rear Connection Type HGM250

• HGM160, 250

Dimension

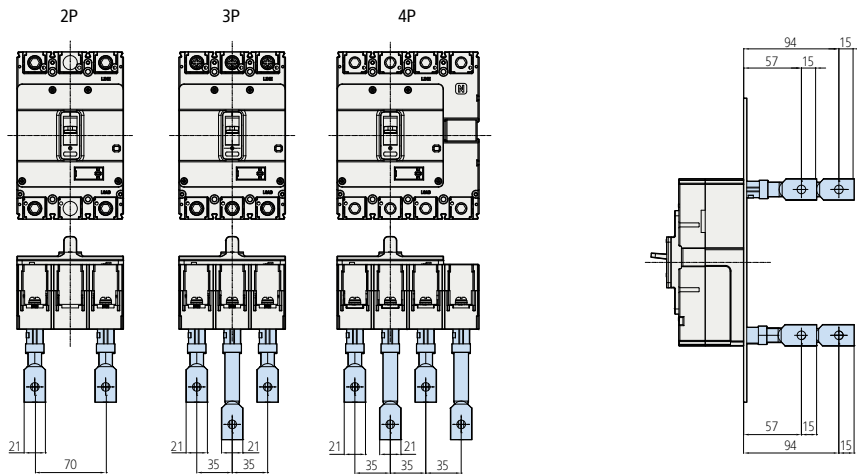

Dimensions for Mounting Body

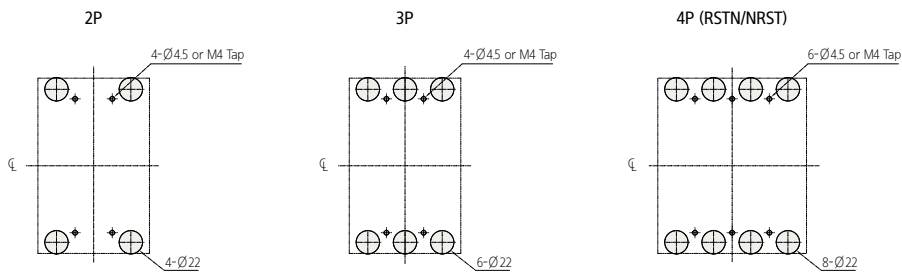

Panel Cover Cutting Dimensions for Handle/Test Button

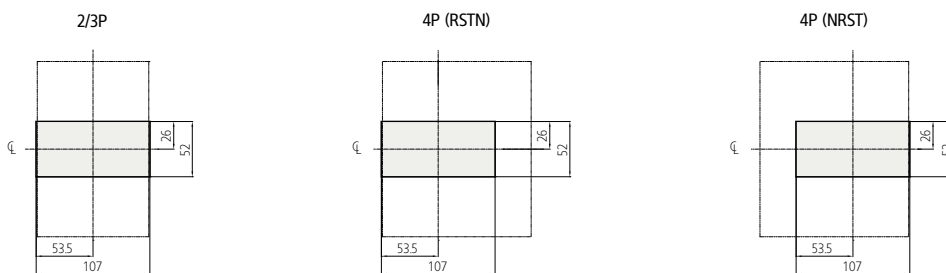

Panel Cover Cutting Dimensions for Handle/Trip Unit

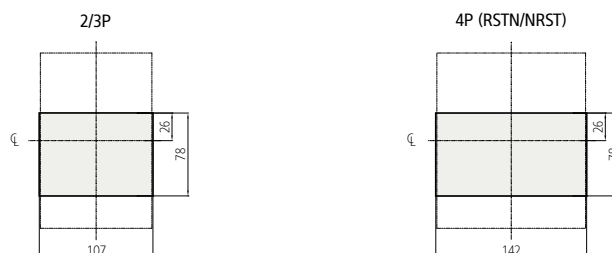

Rear Connection Type HGM400

• HGM400

Dimension

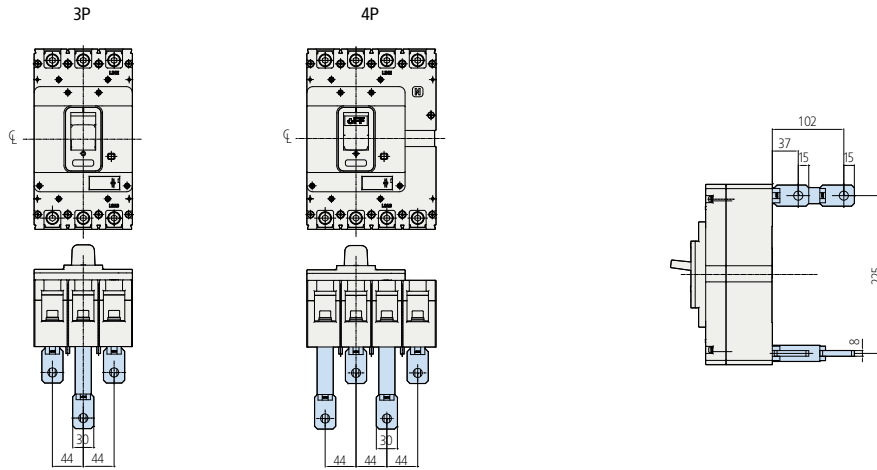

Dimensions for Mounting Body

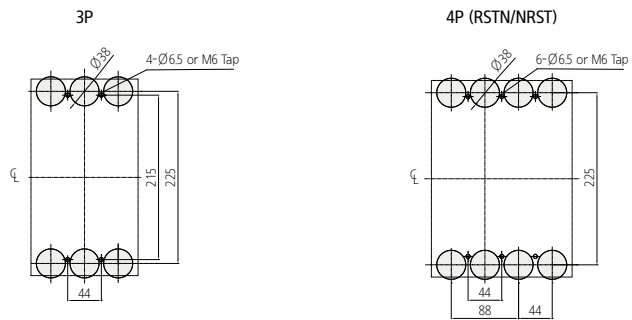

Panel Cover Cutting Dimensions for Handle/Test Button

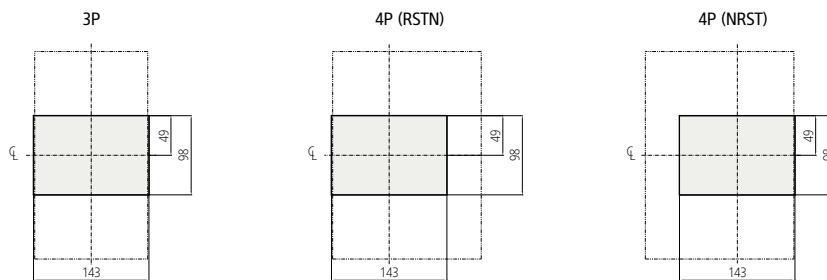

Panel Cover Cutting Dimensions for Handle/Trip Unit

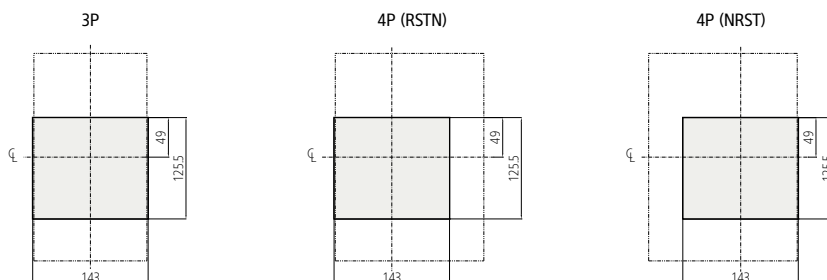

Dimensions

Rear Connection Type HGM800

• HGM630, 800

Dimension

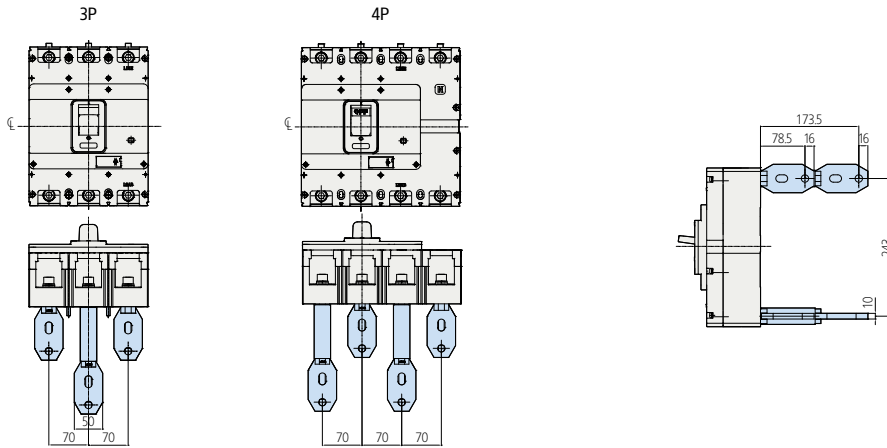

Dimensions for Mounting Body

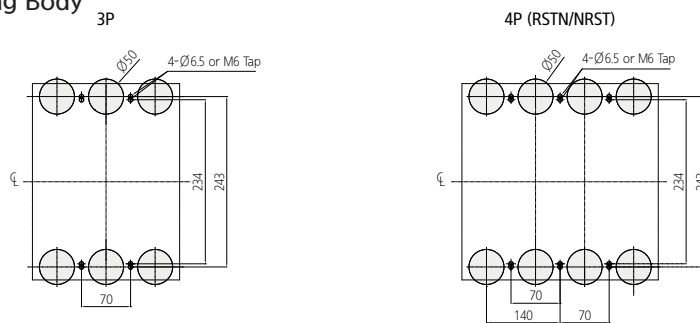

Panel Cover Cutting Dimensions for Handle/Test Button

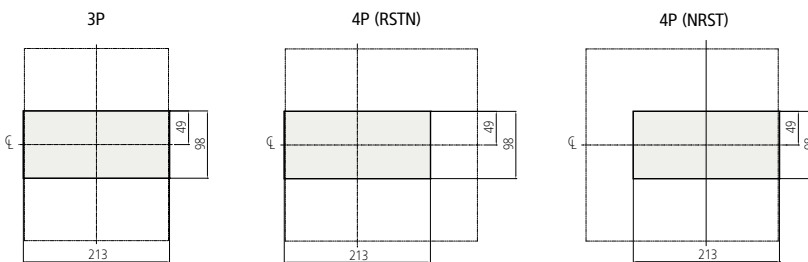

Panel Cover Cutting Dimensions for Handle/Trip Unit

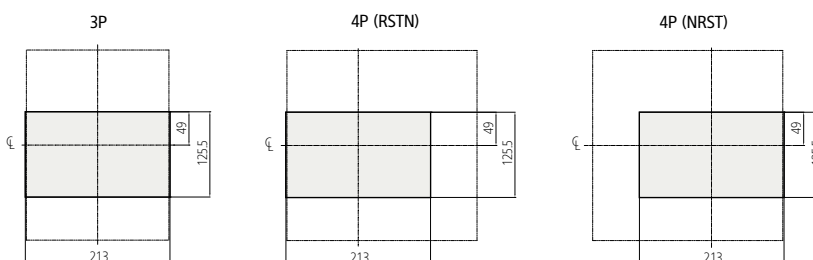

Plug-In Type HGM100

• HGM30, 50E/S, 60, 100

Dimension (TDM Type)

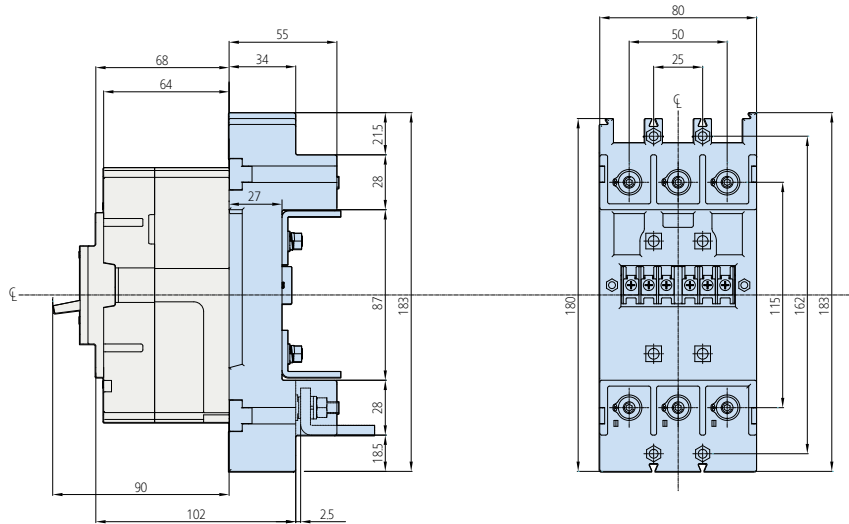

Dimensions for Panel Cutting and Mounting

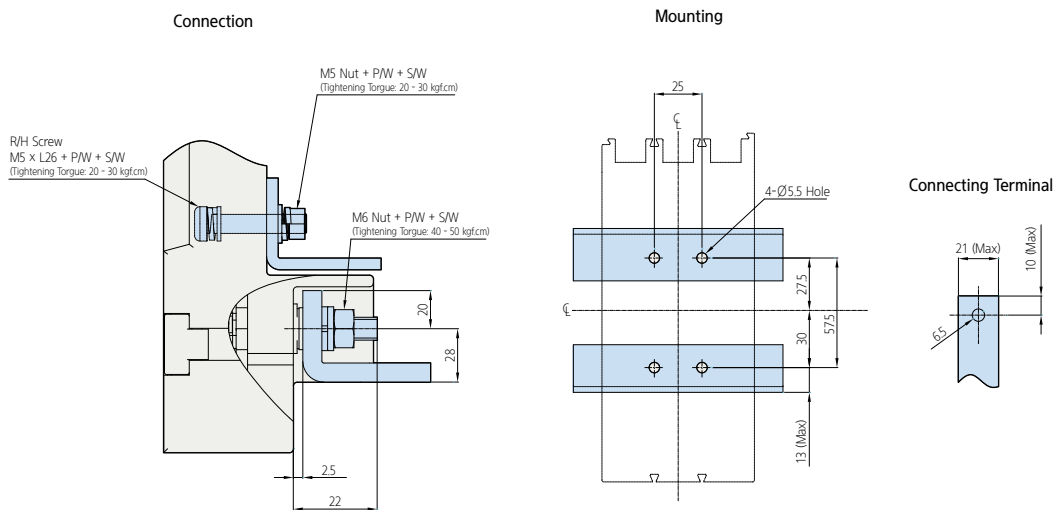

Dimensions

Plug-In Type HGM100

• HGM30, 50E/S, 60, 100

Dimension (TDA D Type)

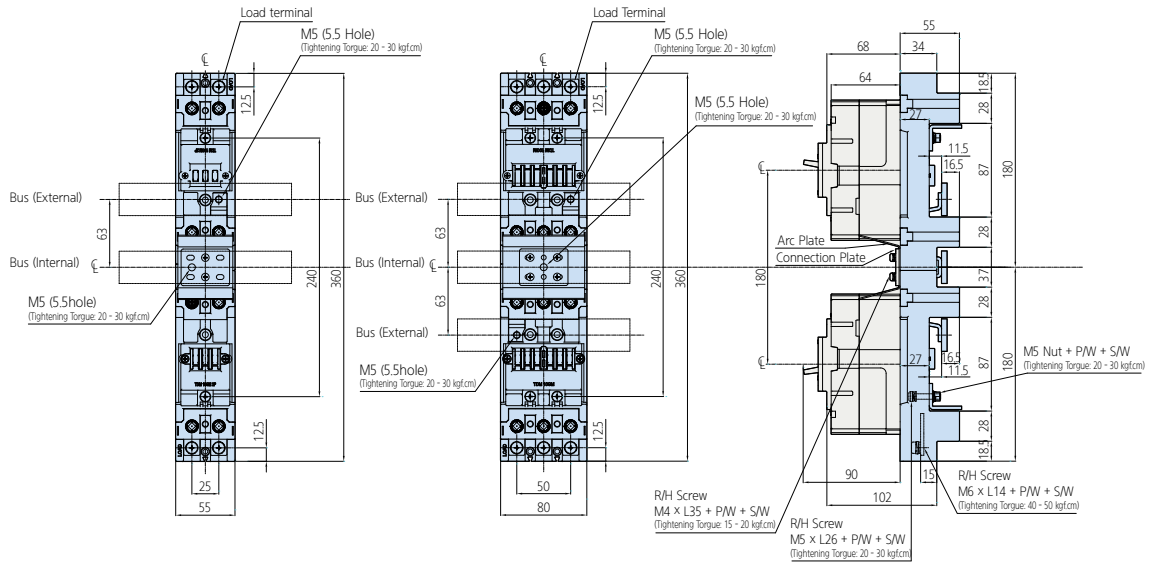

Dimensions for Panel Cutting and Mounting

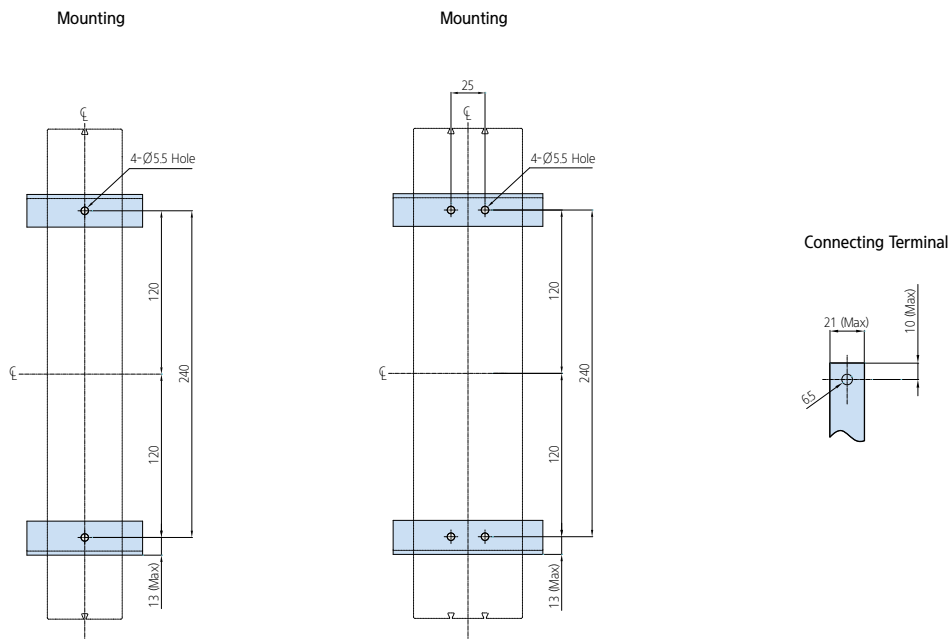

Plug-In Type HGM100

• HGM30, 50E/S, 60, 100

Dimension (TDA S Type)

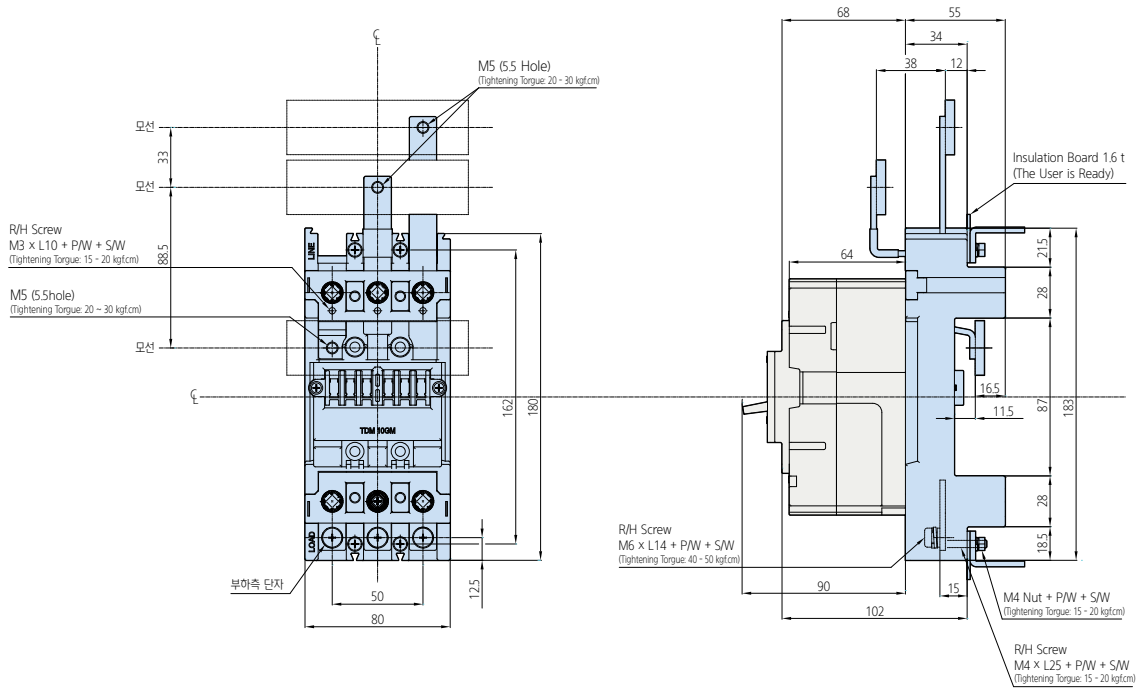

Dimensions for Panel Cutting and Mounting

Mounting

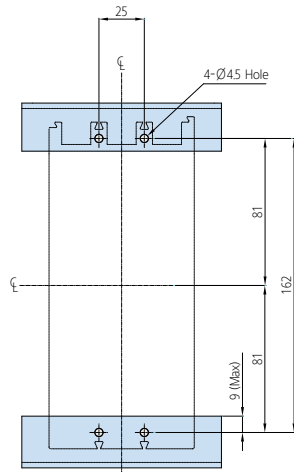

Connecting Terminal

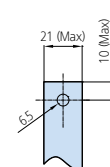

Dimensions

Plug-In Type HGM100

• HGM30, 50E/S, 60, 100

Dimension (TDF Type)

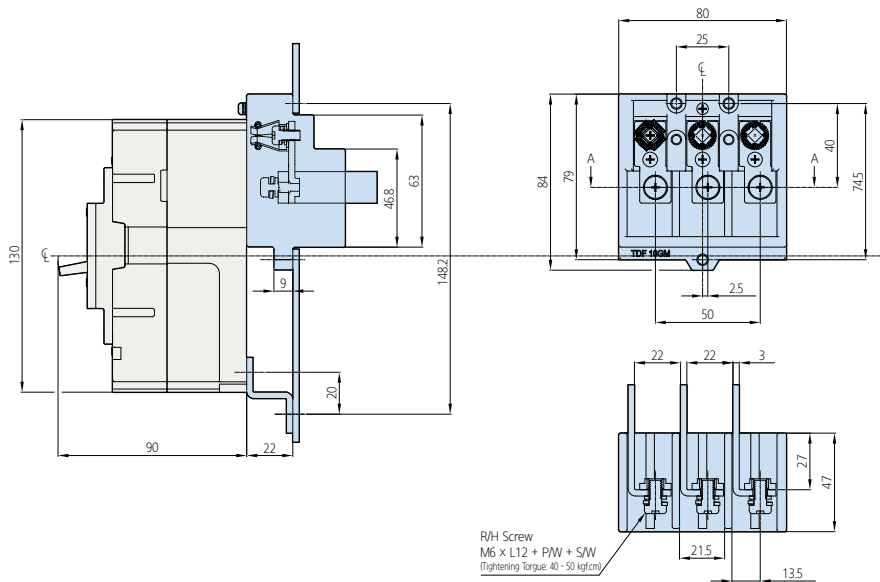

Dimensions for Panel Cutting and Mounting

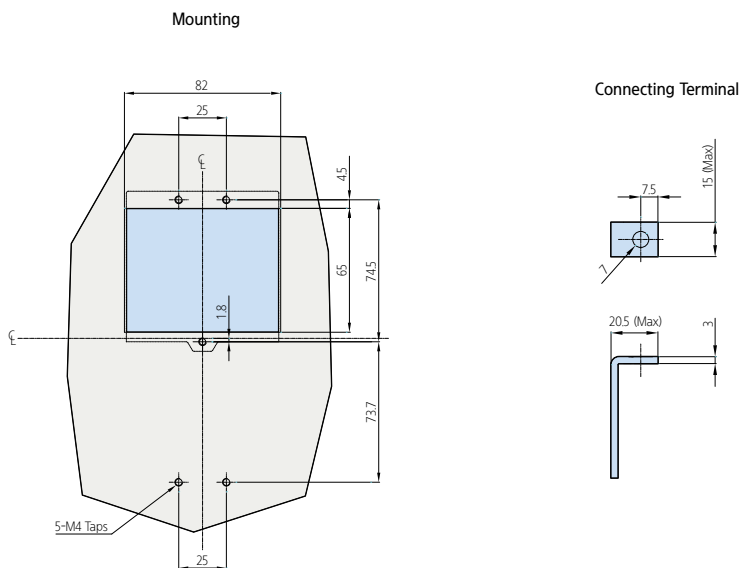

Plug-In Type HGM125

• HGM50H/L, 125

Dimension (TDM Type)

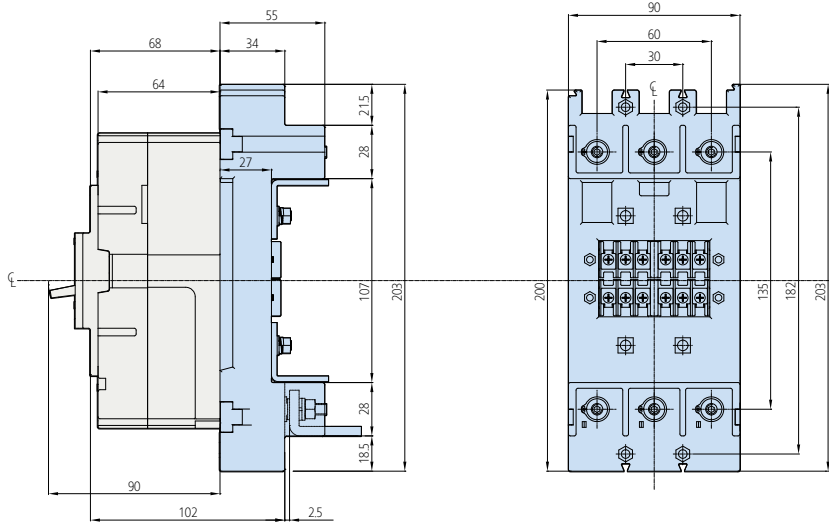

Dimensions for Panel Cutting and Mounting

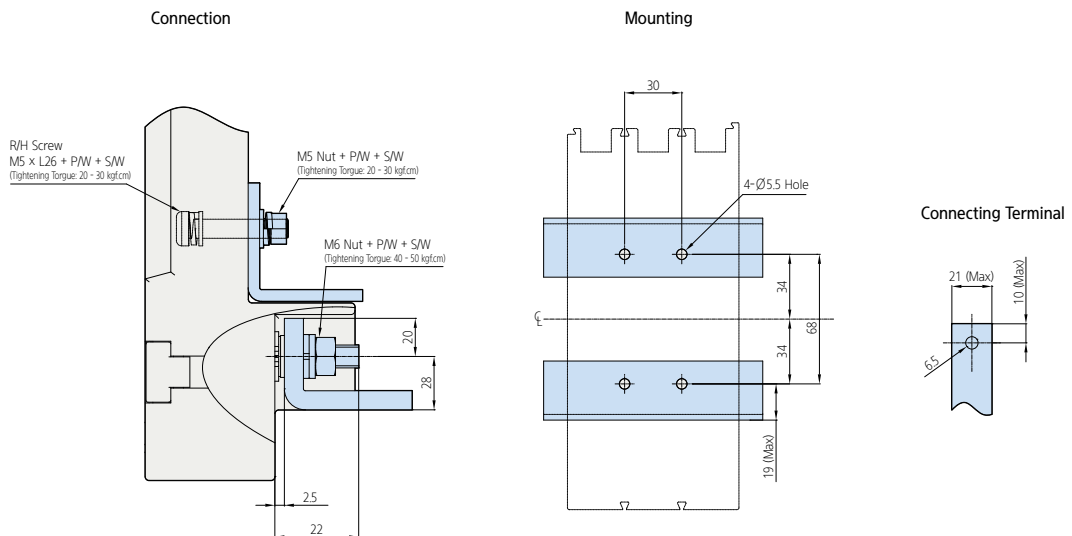

Dimensions

Plug-In Type HGM125

• HGM50H/L, 125

Dimension (TDA D Type)

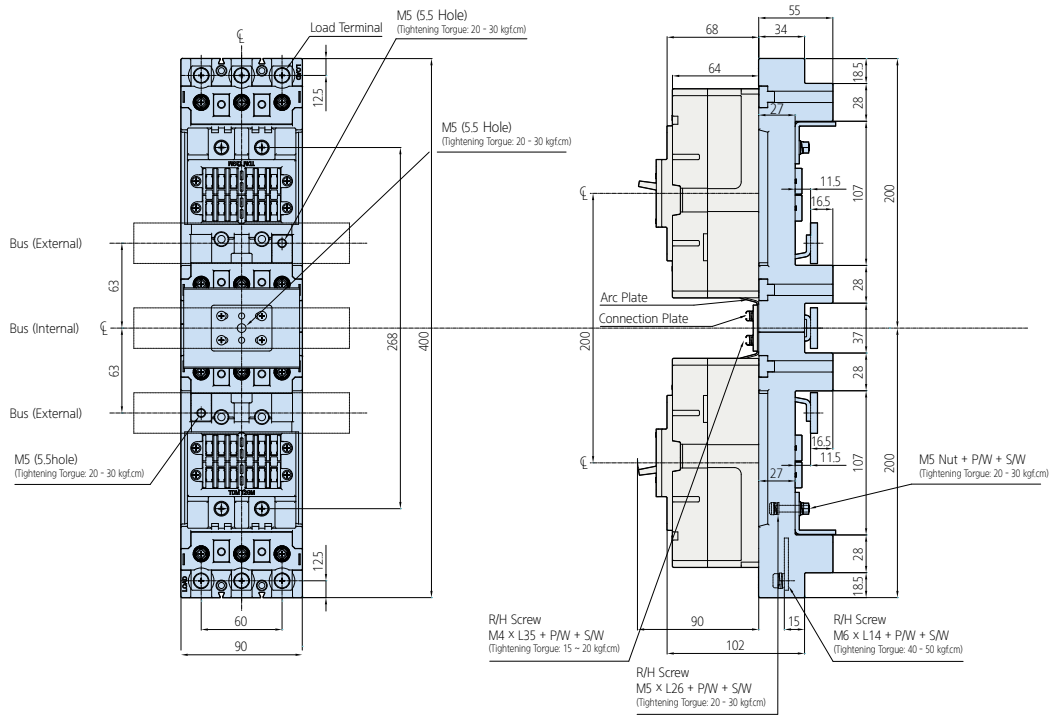

Dimensions for Panel Cutting and Mounting

Mounting

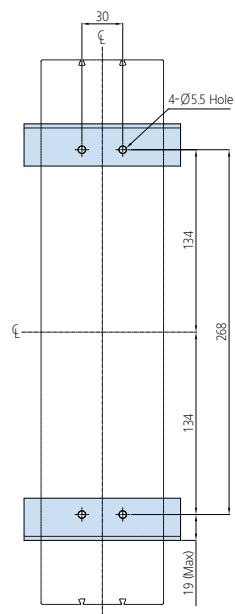

Connecting Terminal

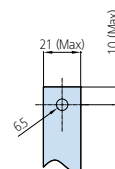

Plug-In Type HGM125

• HGM50H/L, 125

Dimension (TDA S Type)

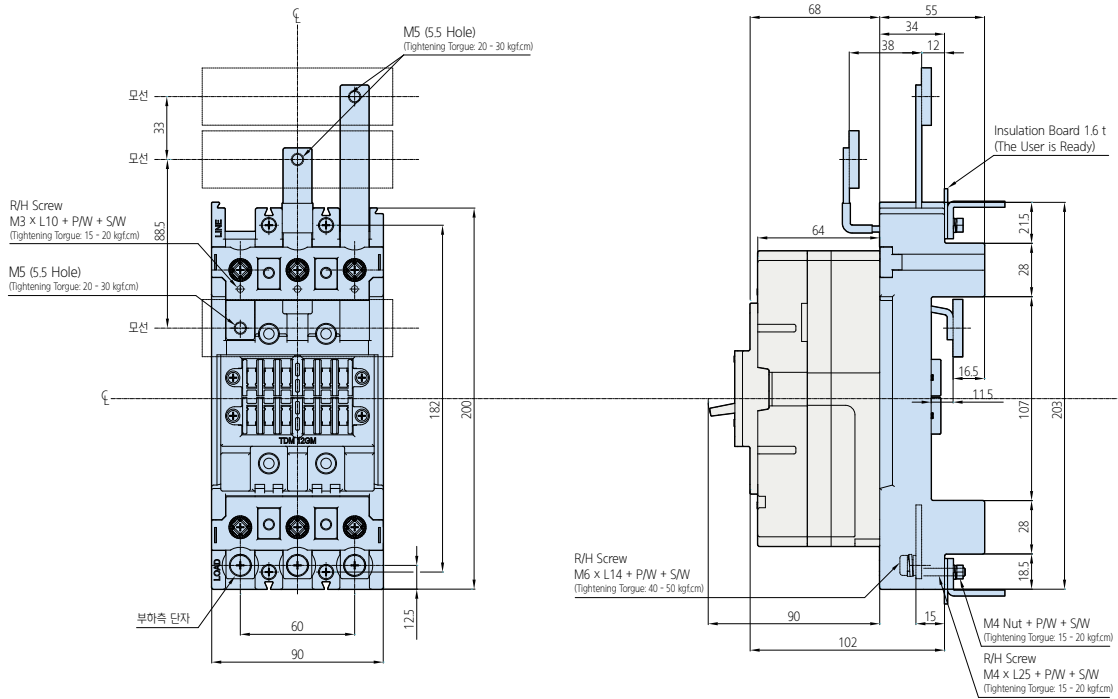

Dimensions for Panel Cutting and Mounting

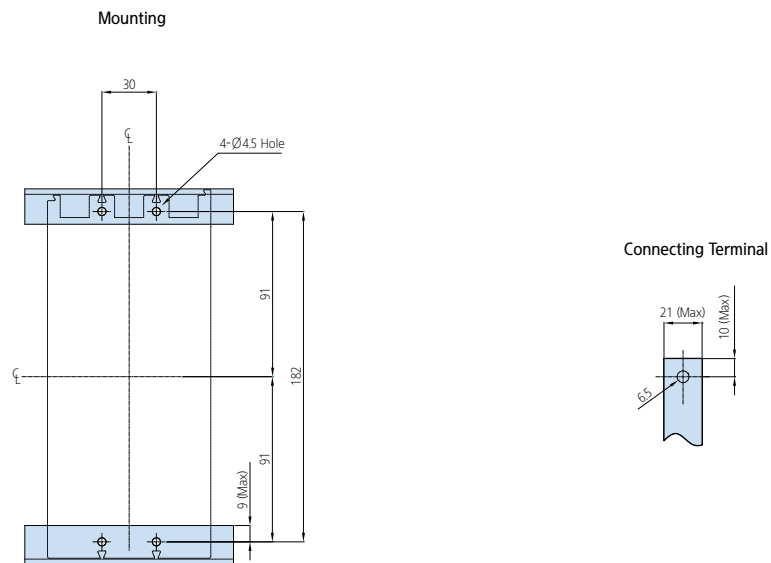

Dimensions

Plug-In Type HGM125

• HGM50H/L, 125

Dimension (TDF Type)

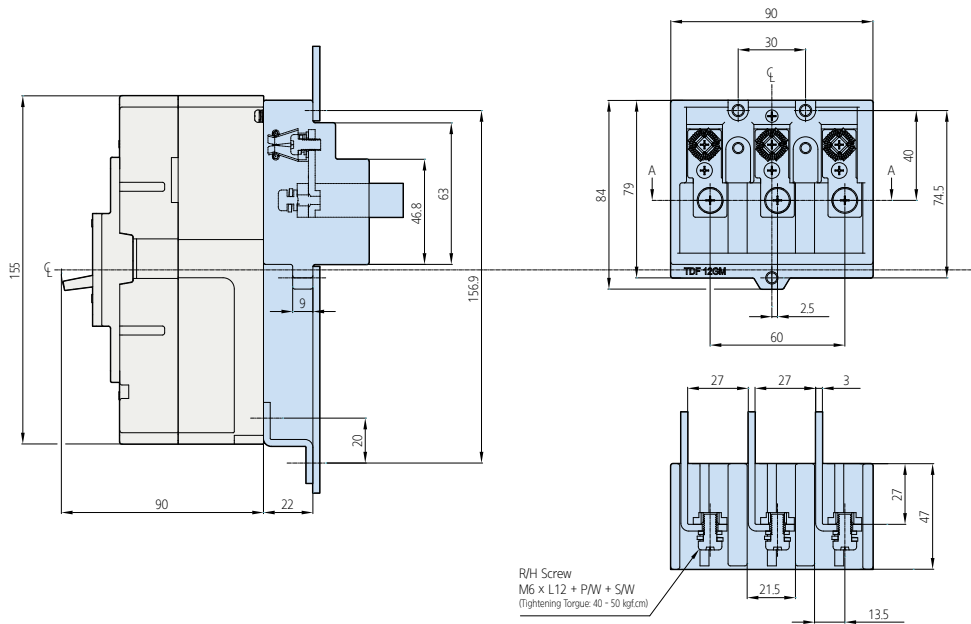

Dimensions for Panel Cutting and Mounting

Mounting

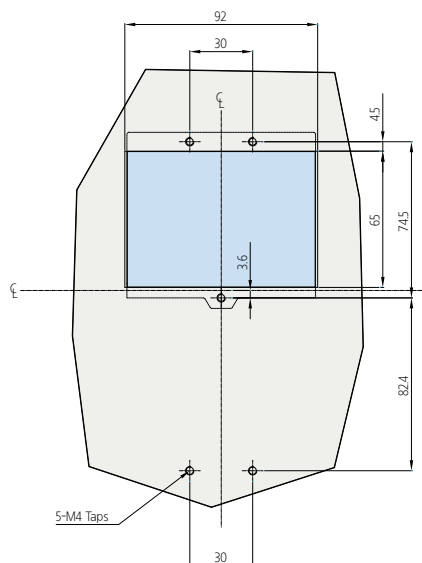

Connecting Terminal

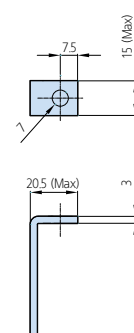

Plug-In Type HGM250

• HGM160, 250

Dimension (TDM Type)

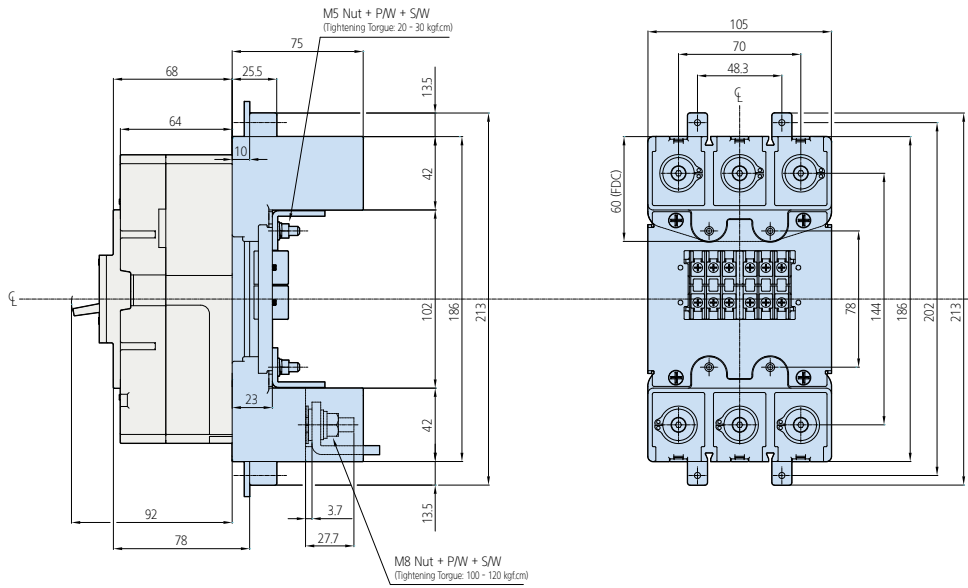

Dimensions for Panel Cutting and Mounting

Mounting

Dimension for Front Cover Cutting

Connecting Terminal

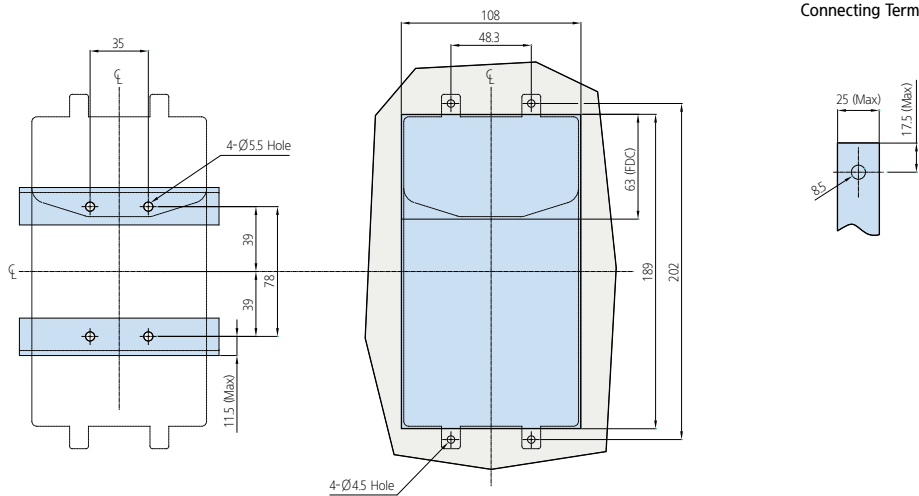

Dimensions

Plug-In Type HGM400

• HGM400

Dimension (TDM Type)

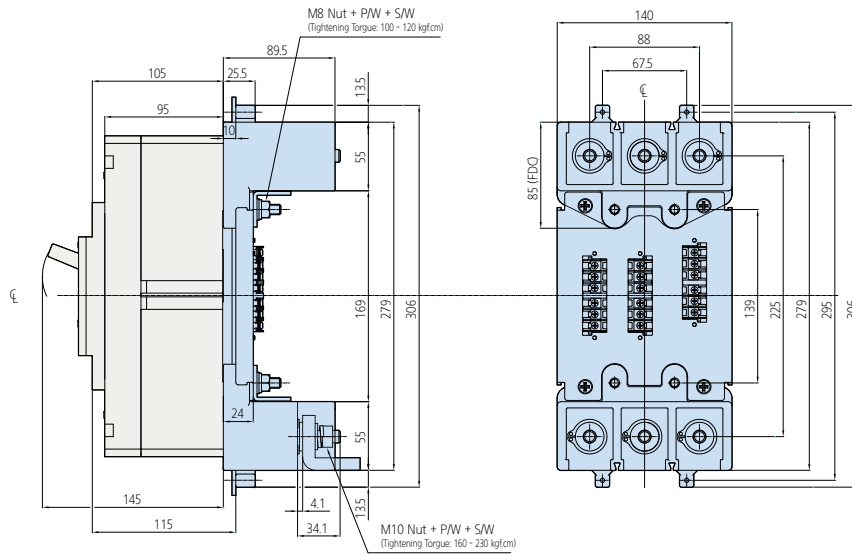

Dimensions for Panel Cutting and Mounting

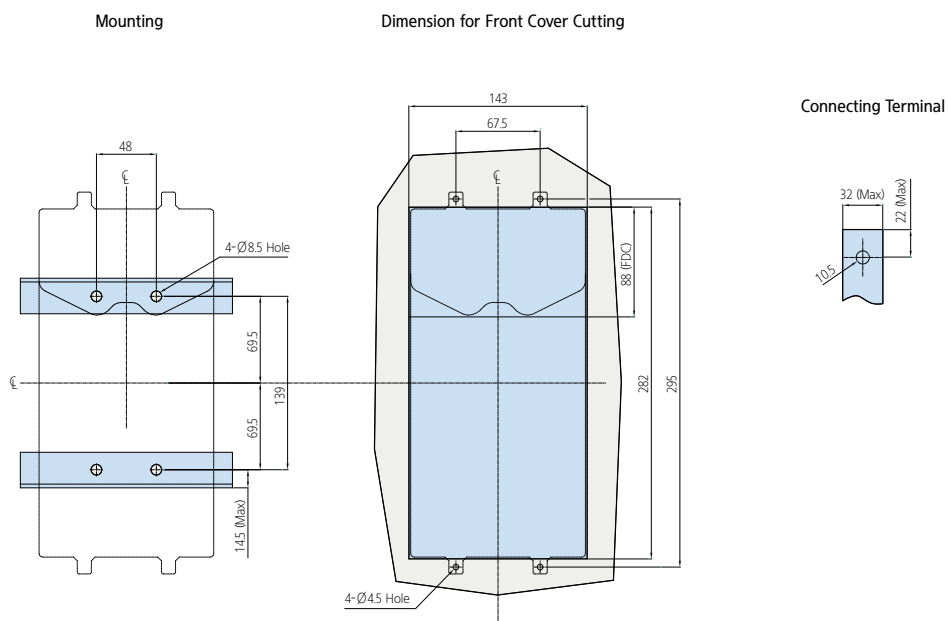

Plug-In Type HGM800

• HGM630, 800

Dimension (TDM Type)

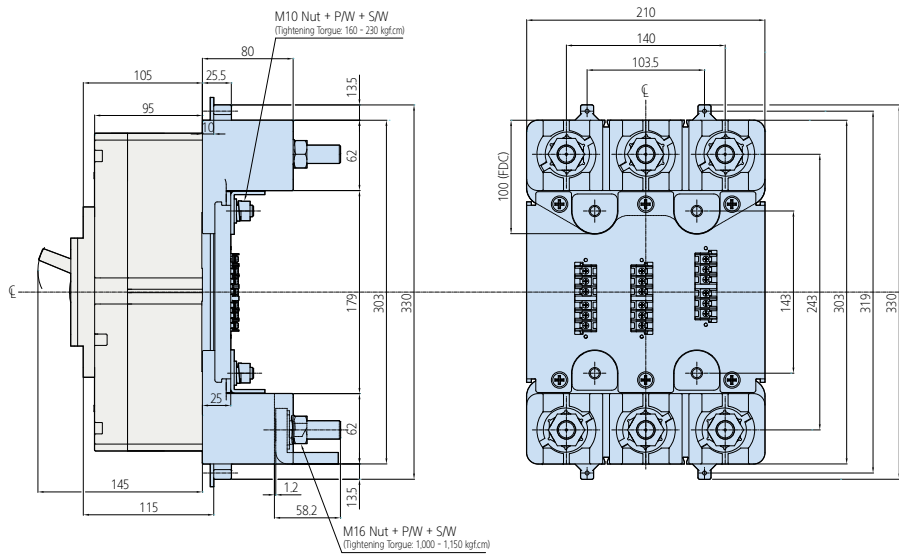

Dimensions for Panel Cutting and Mounting

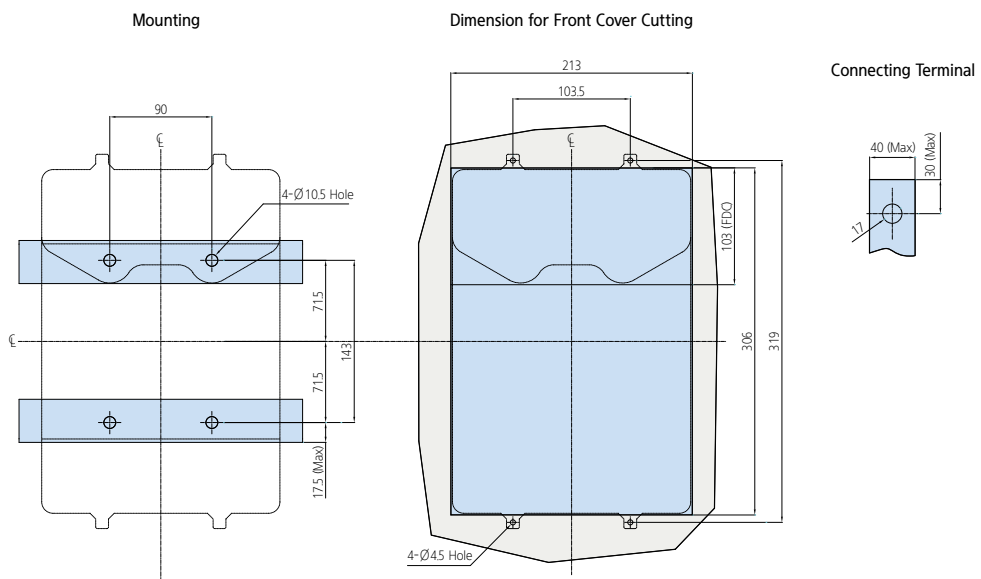

Dimensions

Rotary Handle HGM100

• HGM30, 50E/S, 60, 100

Direct Rotary Handle

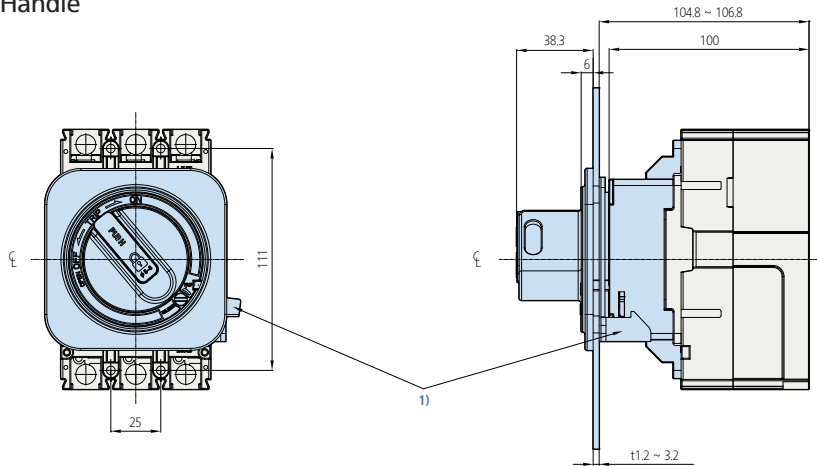

※ 1) Note that the LOCK PLATE may need to be positioned for combined operation with the handle.

Extended Rotary Handle

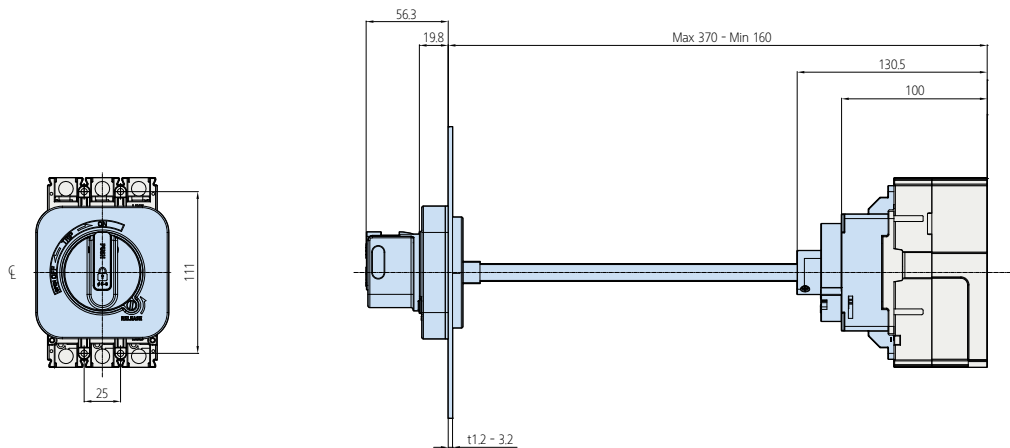

Dimensions for Mounting Body

Direct Rotary Handle

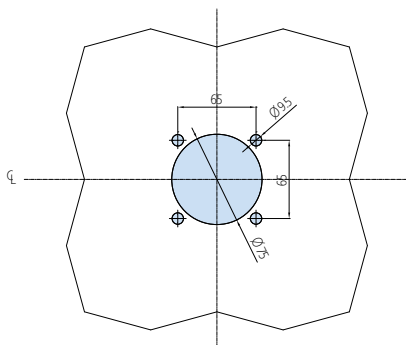

Extended Rotary Handle

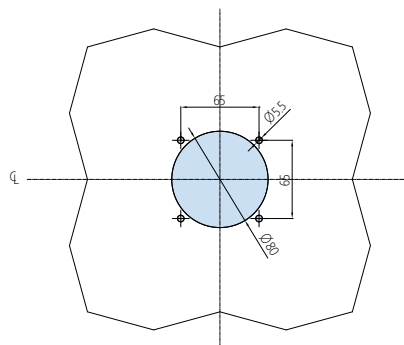

Rotary Handle HGM125

• HGM50H/L, 125

Direct Rotary Handle

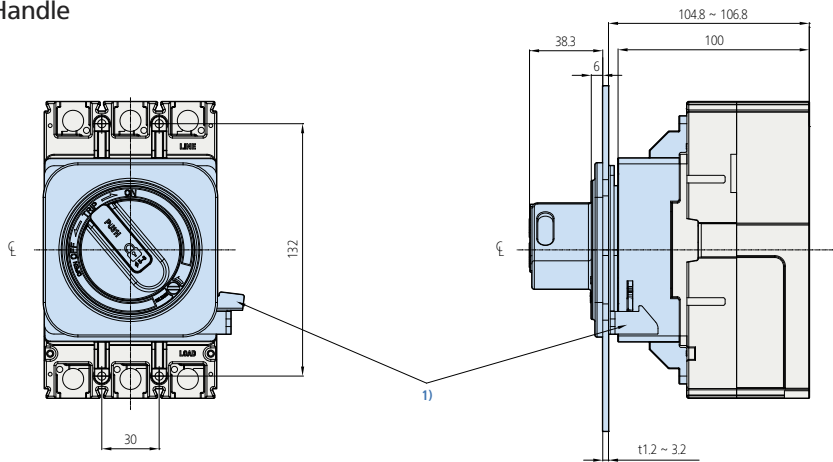

※ 1) Note that the LOCK PLATE may need to be positioned for combined operation with the handle.

Extended Rotary Handle

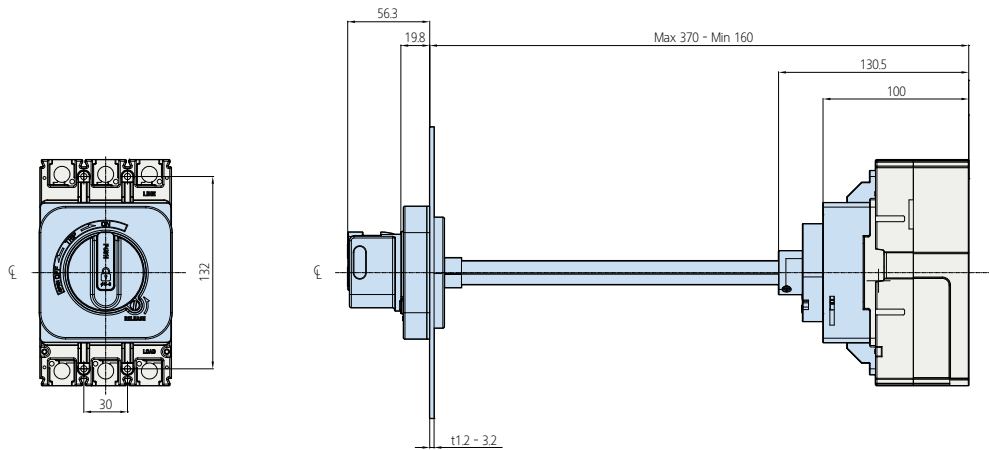

Dimensions for Mounting Body

Direct Rotary Handle

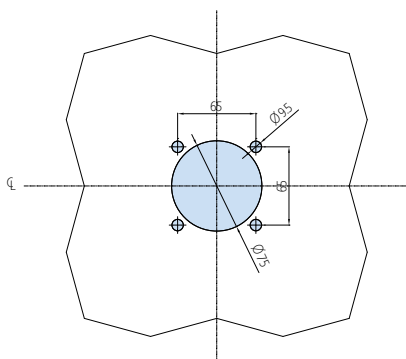

Extended Rotary Handle

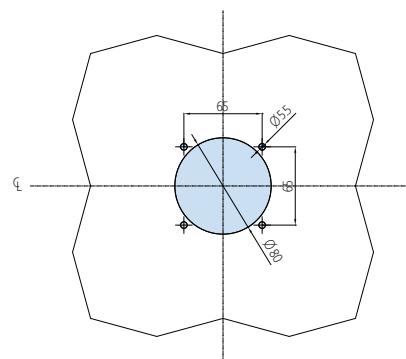

Dimensions

Rotary Handle HGM250

• HGM160, 250

Direct Rotary Handle

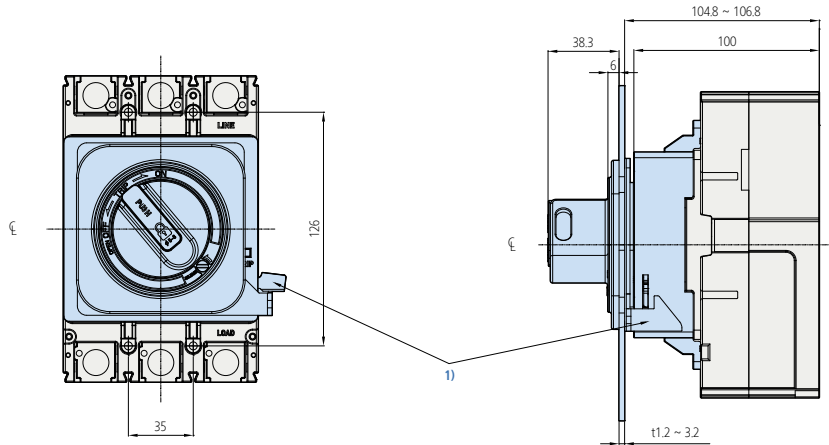

※ 1) Note that the LOCK PLATE may need to be positioned for combined operation with the handle.

Extended Rotary Handle

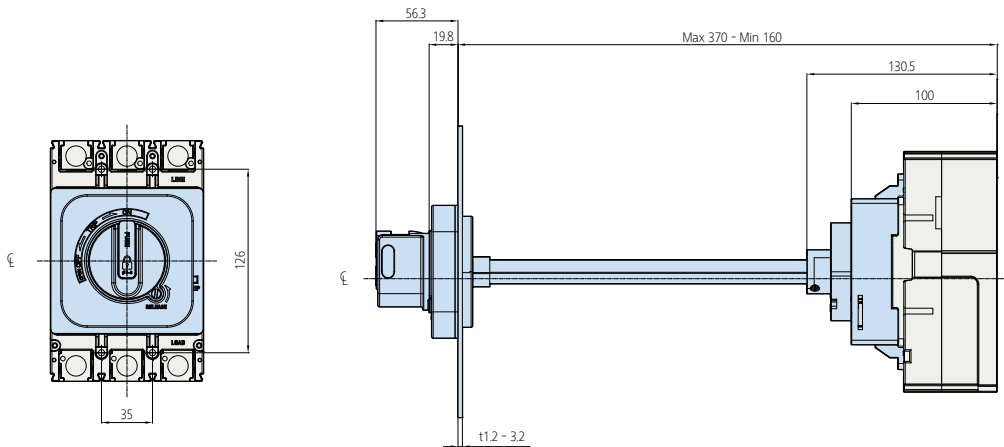

Dimensions for Mounting Body

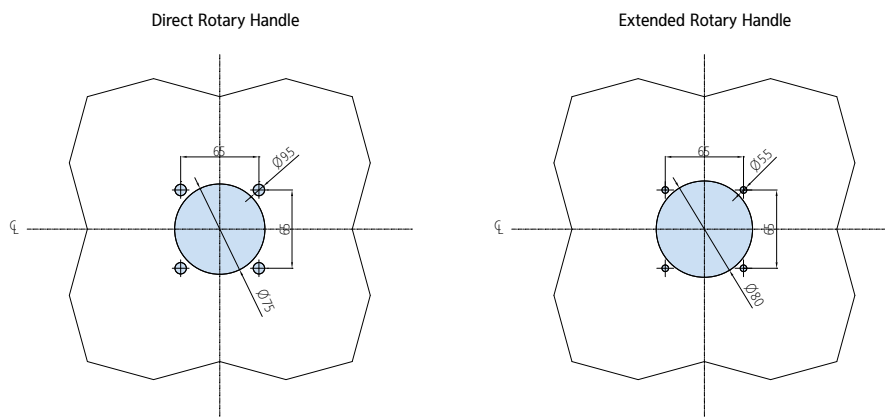

Rotary Handle HGM400

• HGM400

Direct Rotary Handle

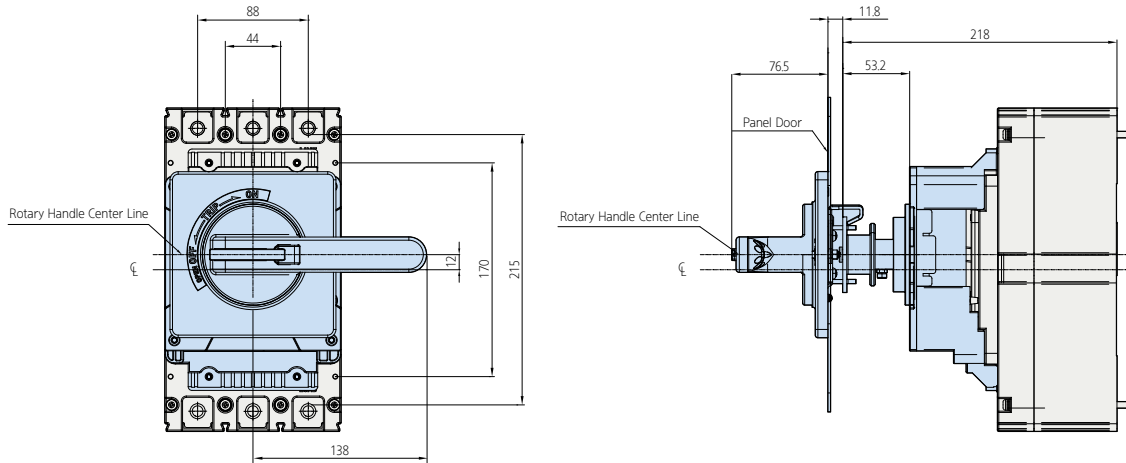

Extended Rotary Handle

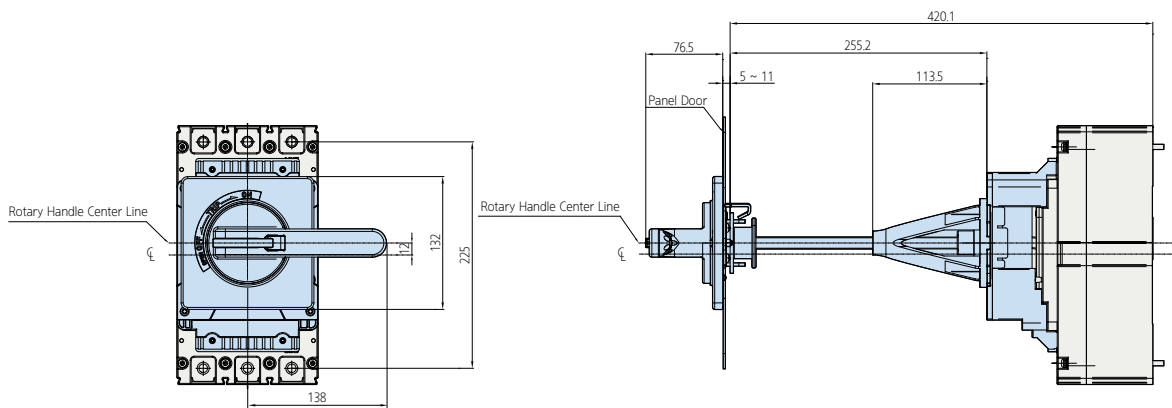

Dimensions for Mounting Body

Direct Rotary Handle

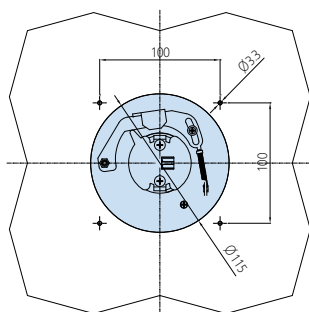

Extended Rotary Handle

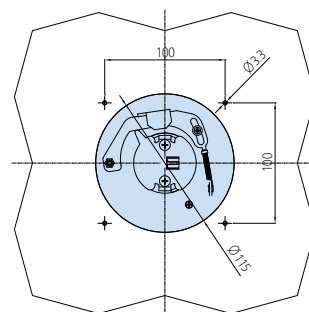

Dimensions

Rotary Handle HGM800

• HGM630, 800

Direct Rotary Handle

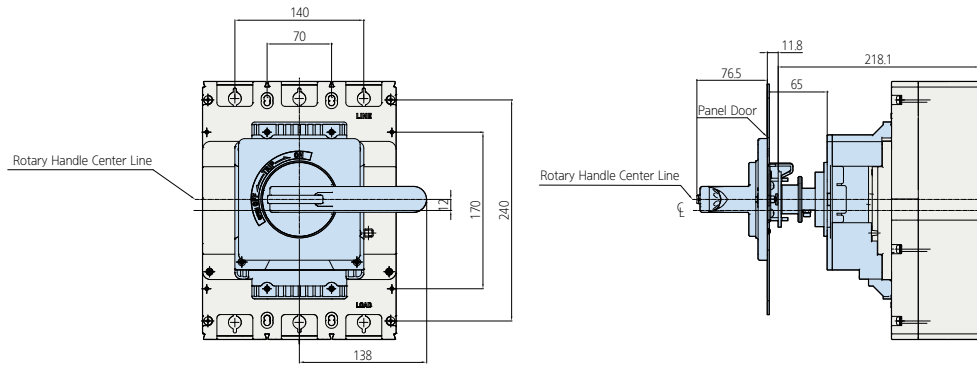

Extended Rotary Handle

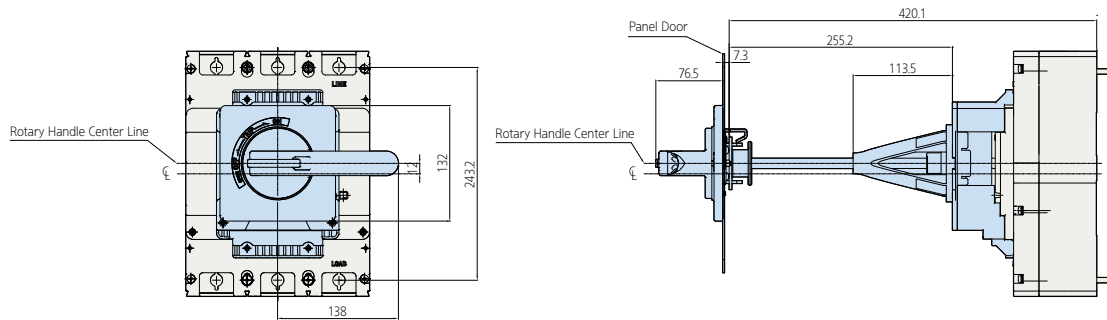

Dimensions for Mounting Body

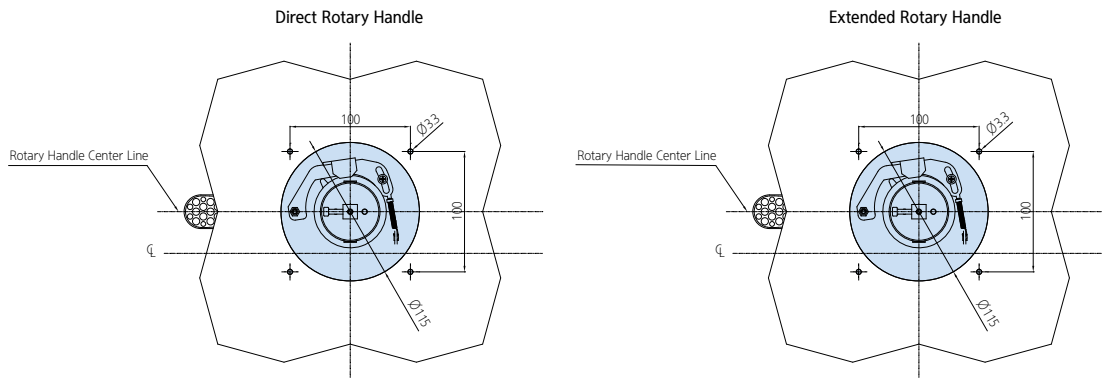

Mechanical Interlock HGM100

• HGM30, 50E/S, 60, 100

Dimension

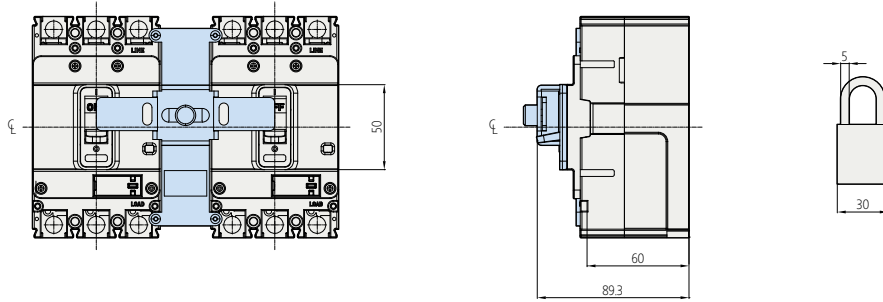

Dimensions for Mounting Body

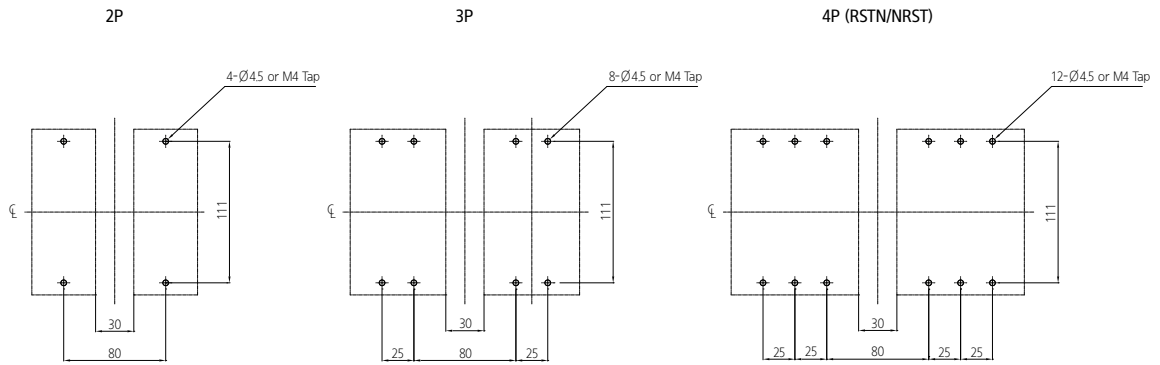

Panel Cover Cutting Dimension

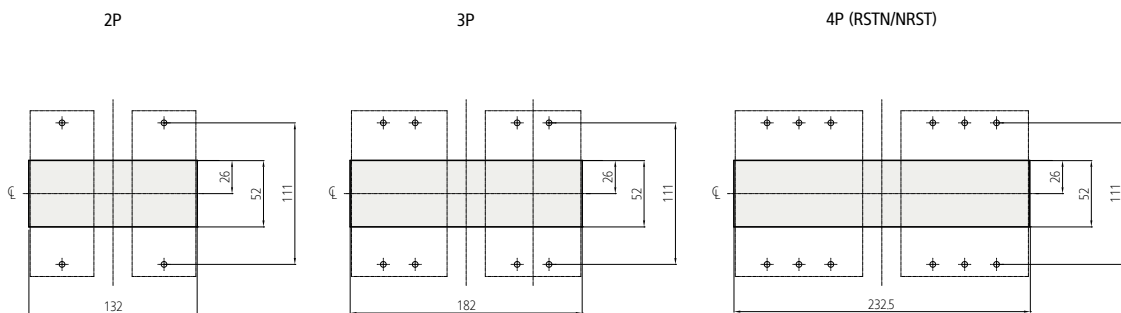

Dimensions

Mechanical Interlock HGM125

• HGM50H/L, 125

Dimension

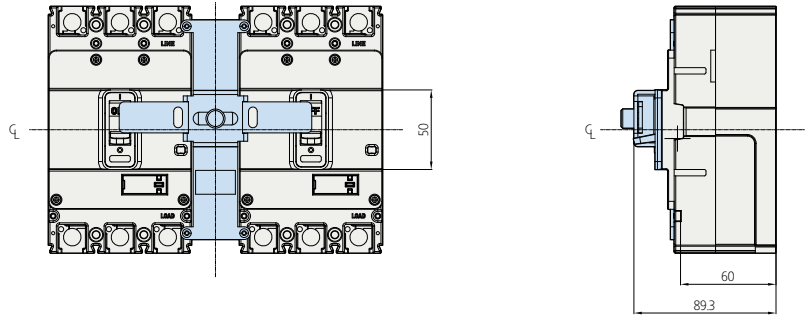

Dimensions for Mounting Body

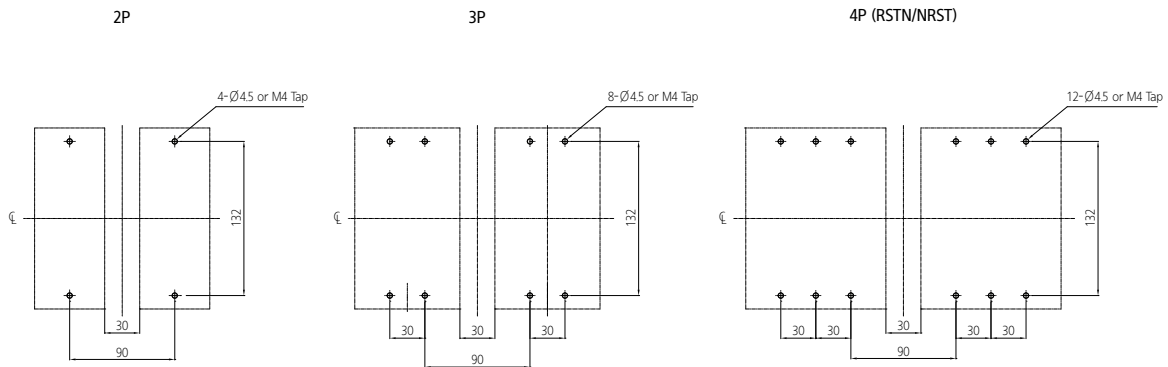

Panel Cover Cutting Dimension

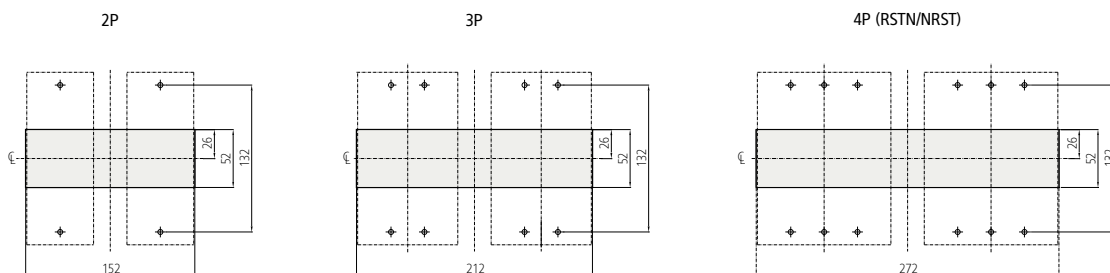

Mechanical Interlock HGM250

• HGM160, 250

Dimension

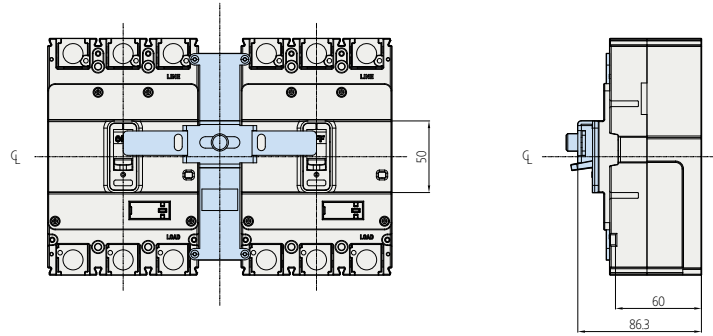

Dimensions for Mounting Body

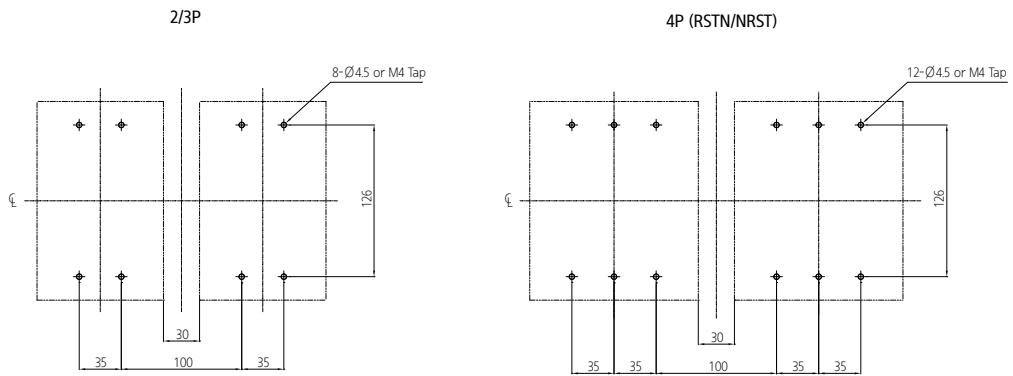

Panel Cover Cutting Dimension

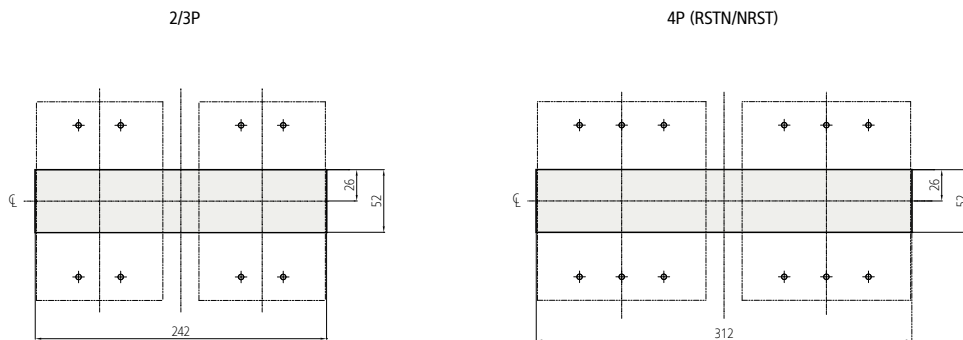

Dimensions

Mechanical Interlock HGM400

• HGM400

Dimension

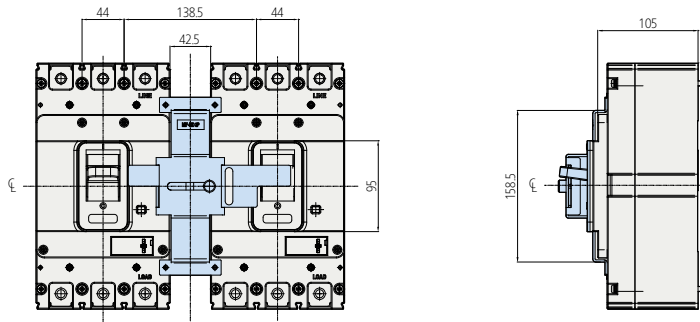

Dimensions for Mounting Body

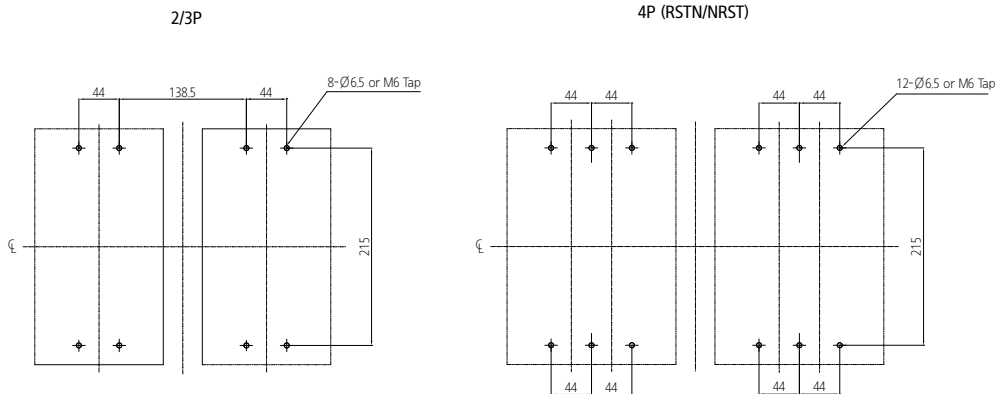

Panel Cover Cutting Dimension

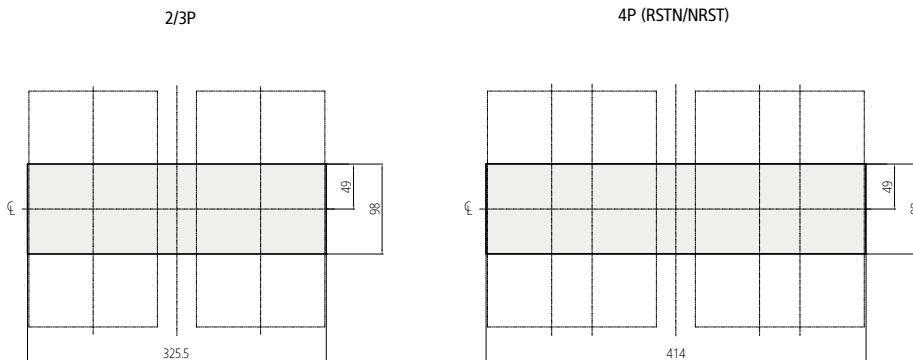

Mechanical Interlock HGM800

• HGM630, 800

Dimension

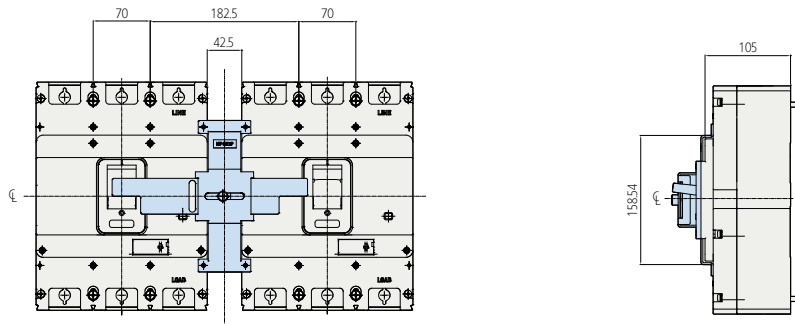

Dimensions for Mounting Body

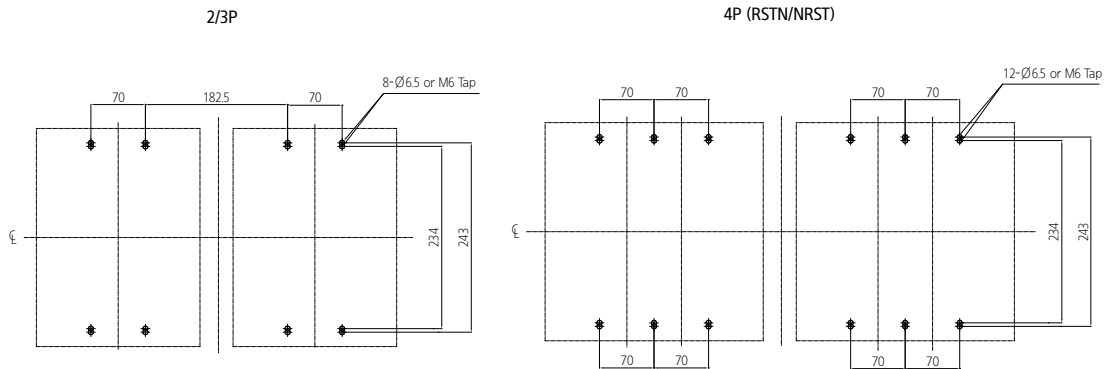

Panel Cover Cutting Dimension

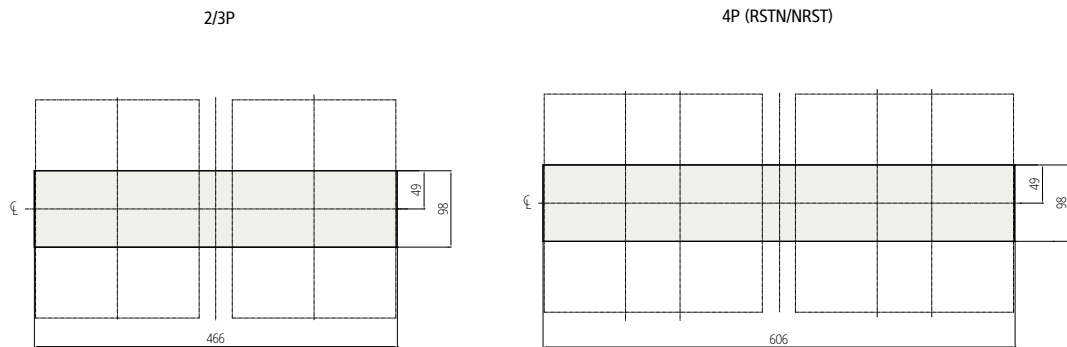

Dimensions

Terminal Cover HGM100

• HGM30, 50E/S, 60, 100

Long Type

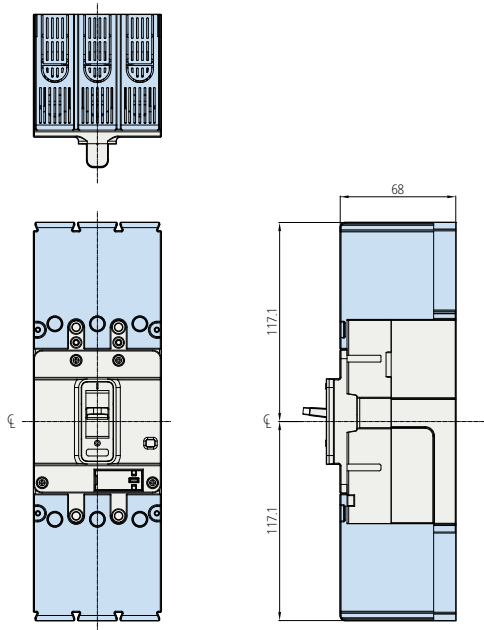

Short Type

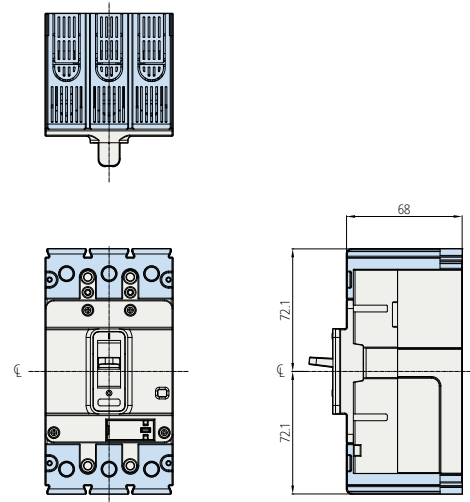

Terminal Cover HGM125

• HGM50H/L, 125

Long Type

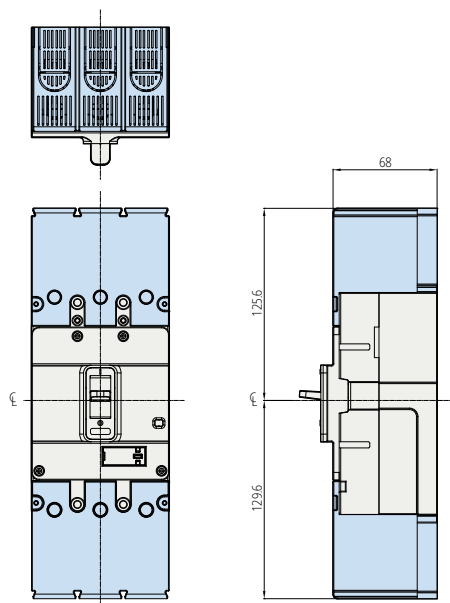

Short Type

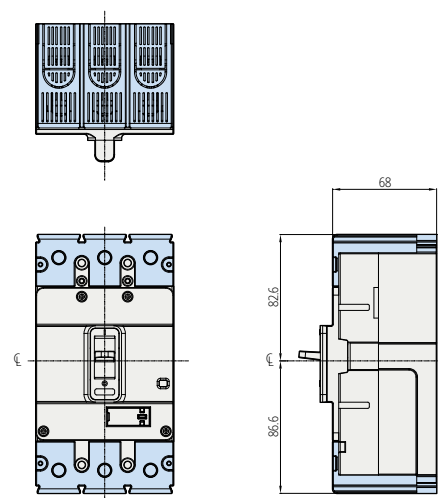

Terminal Cover HGM250

• HGM160, 250

Long Type

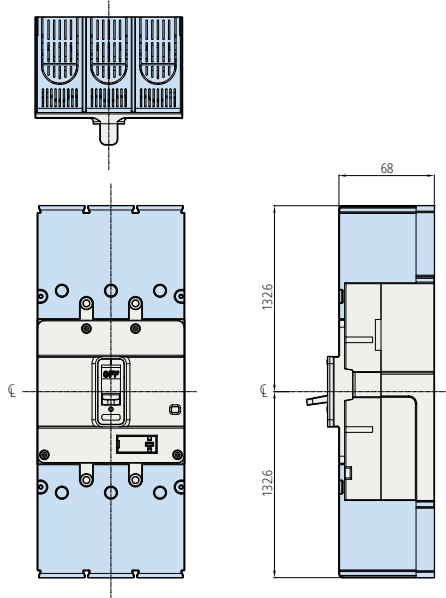

Short Type

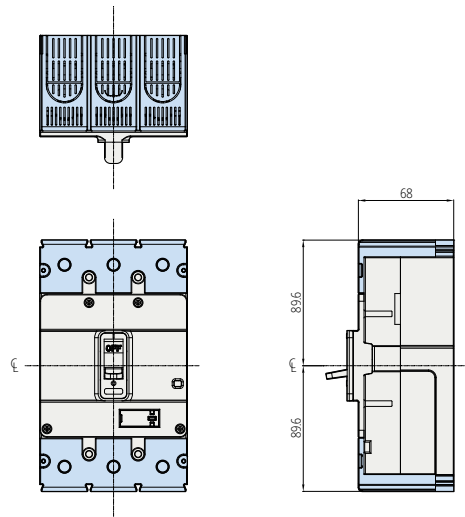

Terminal Cover HGM400

• HGM400

Long Type

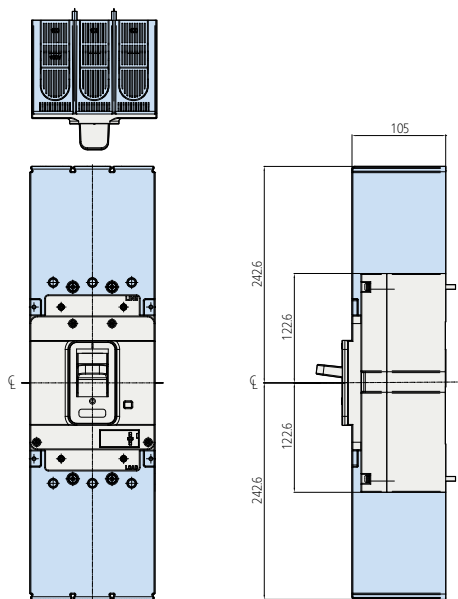

Short Type

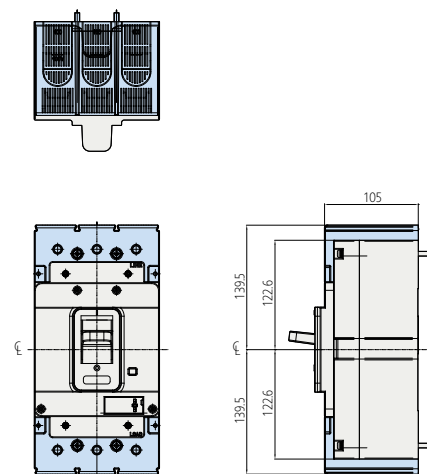

Dimensions

Terminal Cover HGM800

• HGM630, 800

Long Type

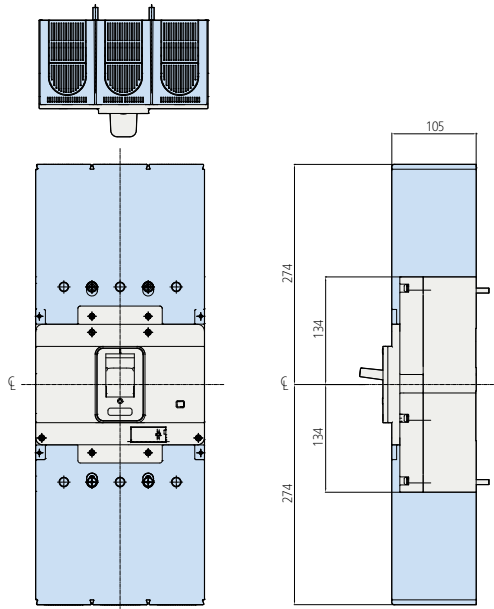

Short Type

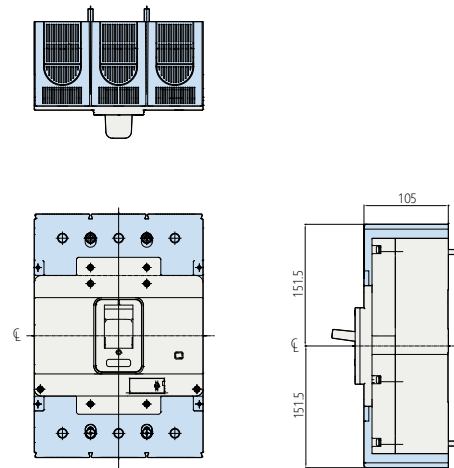

Motor Operator

HGM30, 50E/S, 60, 100

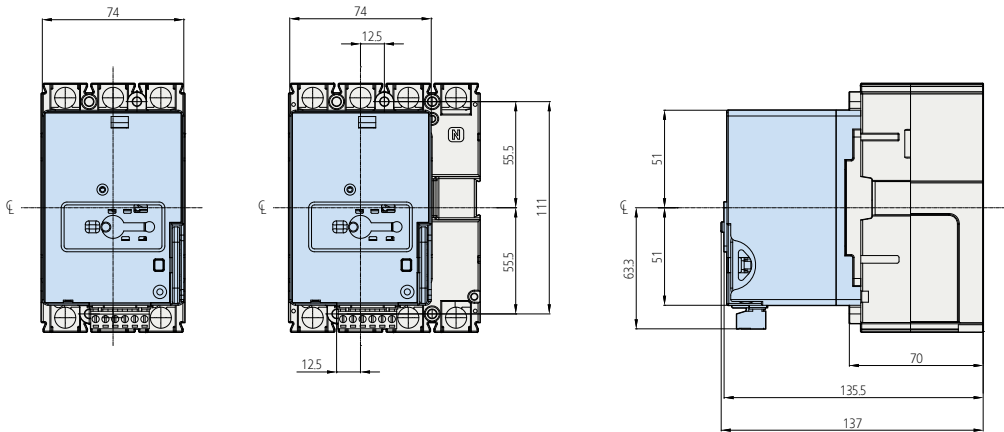

HGM50H/L, 125

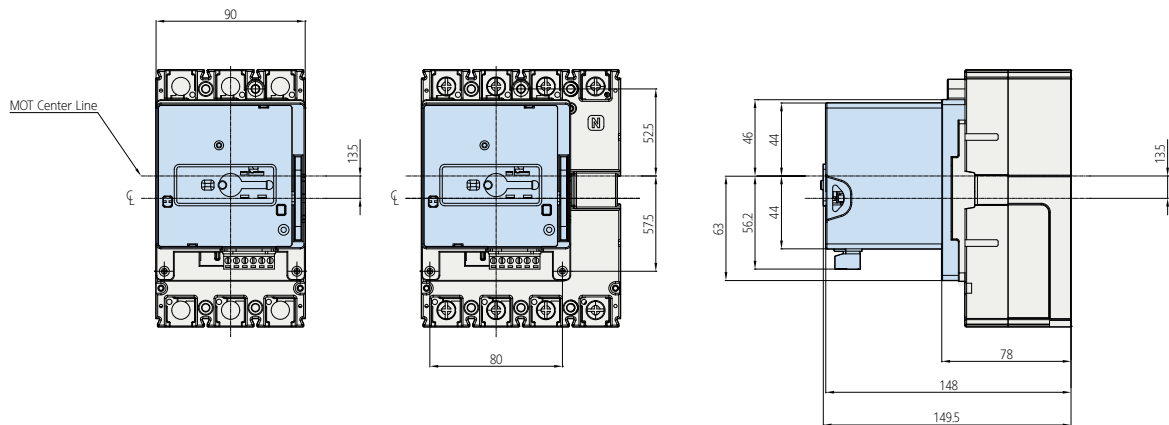

HGM160, 250

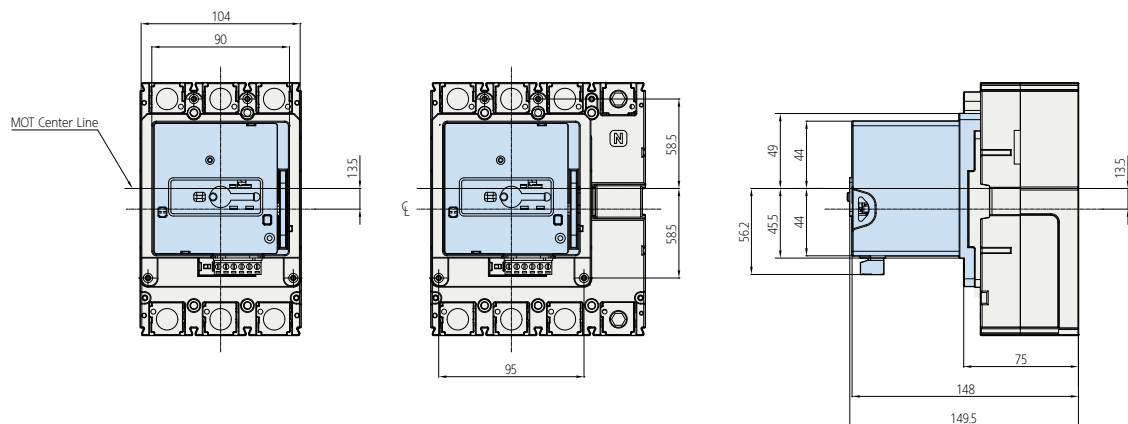

Dimensions

Motor Operator

HGM400

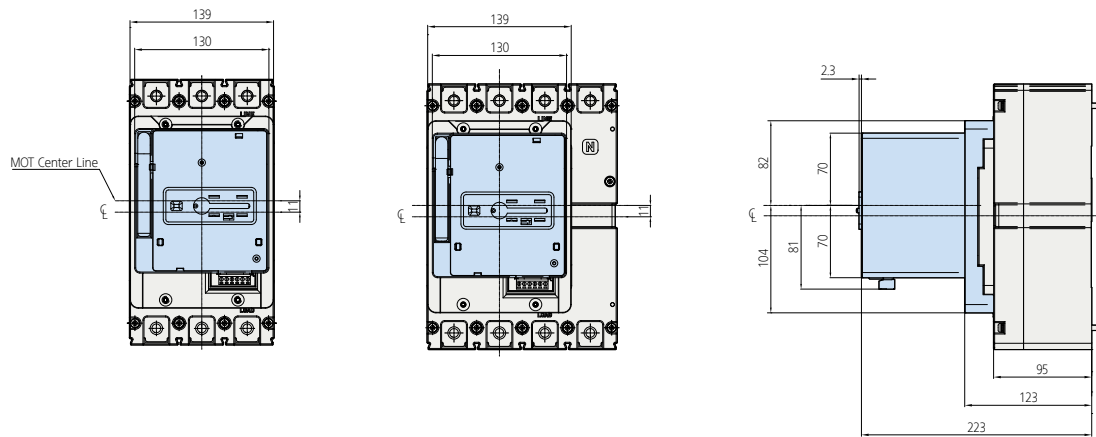

HGM630, 800

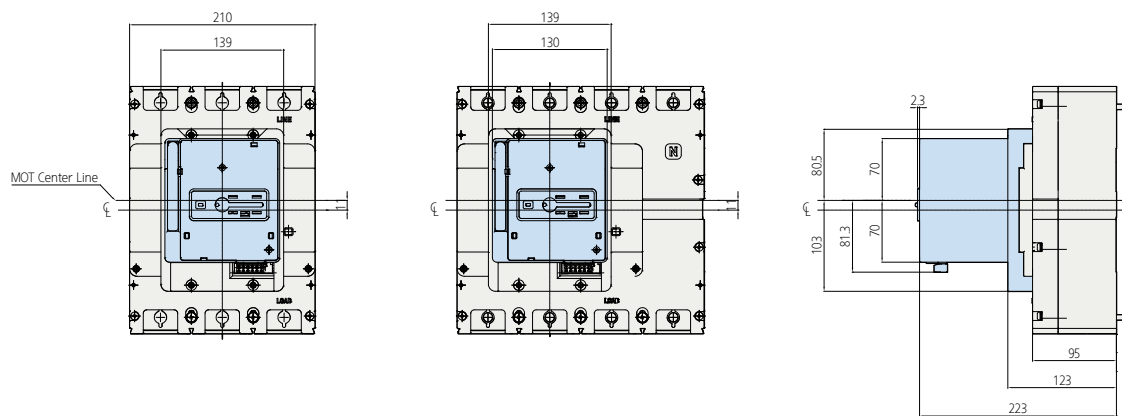

Lug Terminal

HGM30, 50E/S, 60, 100

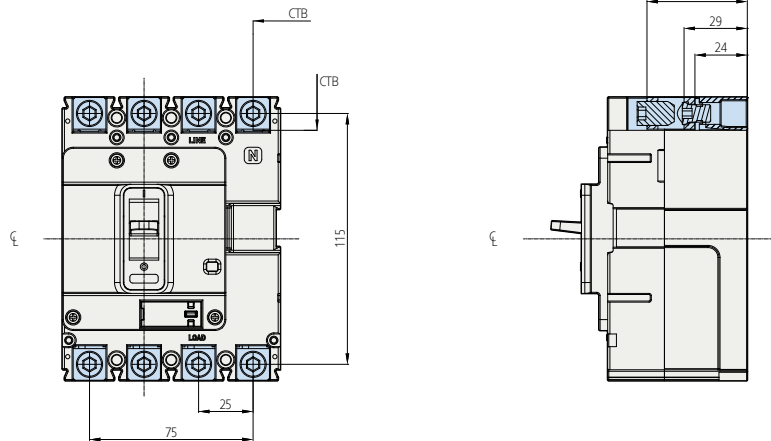

HGM50H/L, 125

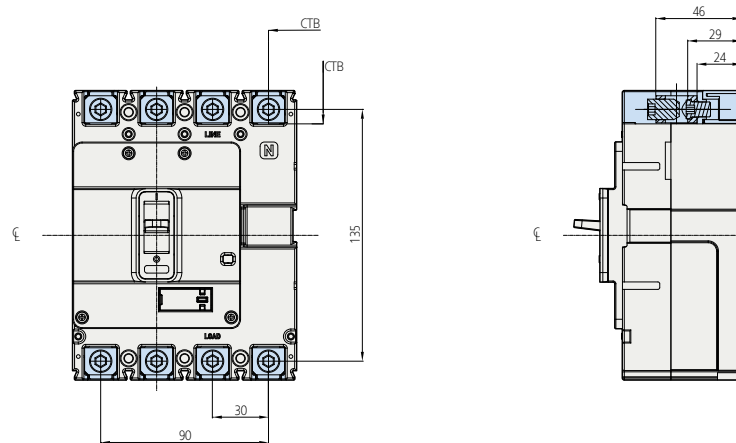

HGM160, 250

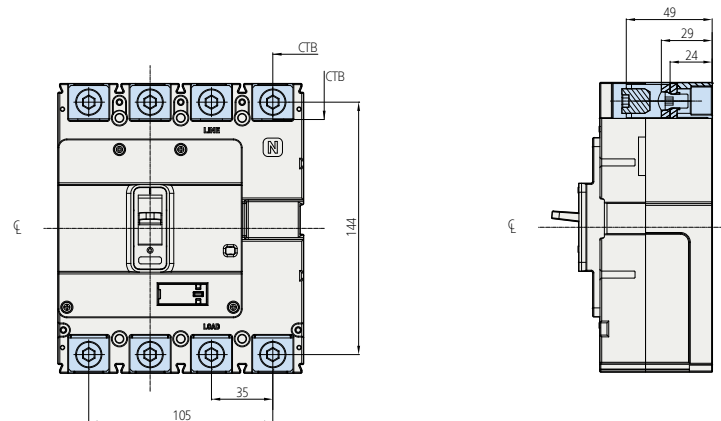

※ When using the CTB, please apply lime/load insulation barrier.

Dimensions

Lug Terminal

HGM400

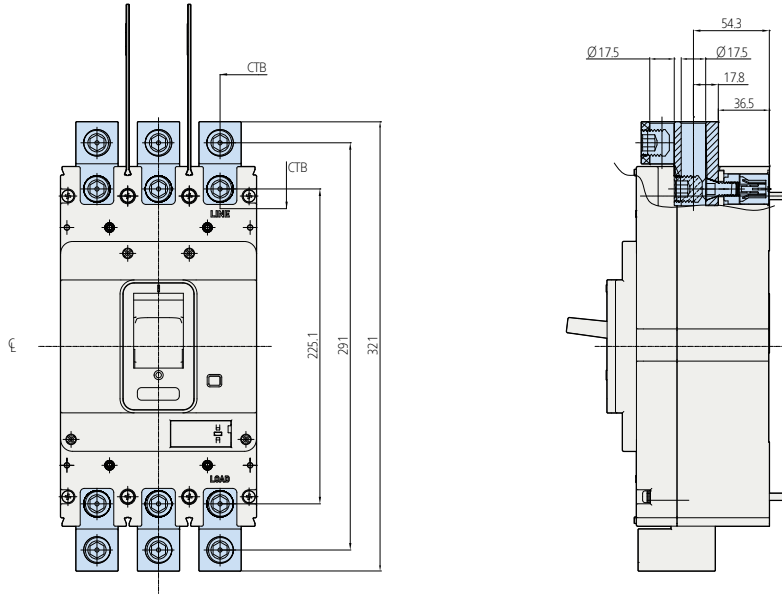

HGM630, 800

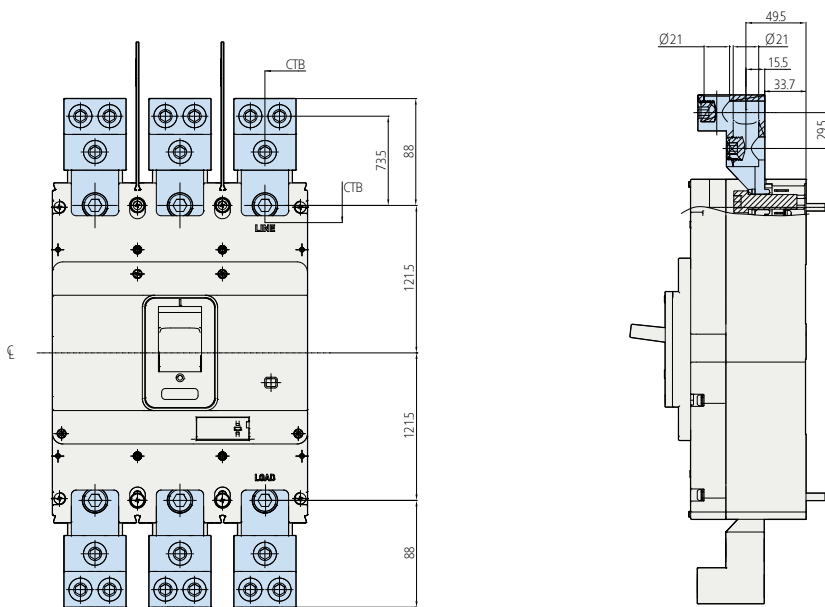

※ When using the CTB, please apply lime/load insulation barrier.

DIN Rail Adaptor

• HGM100

DIN Rail Mounting Hole

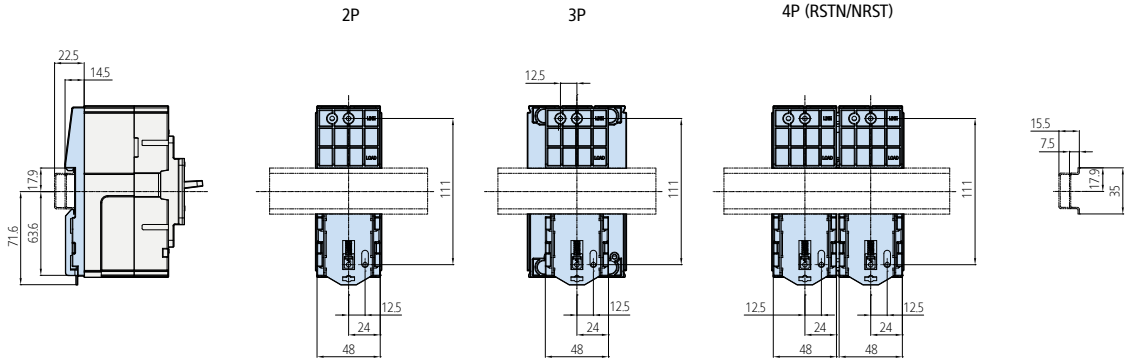

Order Information

Order Information 122

Ordering Codes

HGM Type Molded Case Circuit Breakers (MCCB) 123
HGM Type ZCT Molded Case Circuit Breakers (ZCT MCCB) 135
HGE Type Earth Leakage Circuit Breaker (ELCB) 141
HGM/HGE Type Accessory Separately 153

Order Information

HG Type MCCB, ELCB

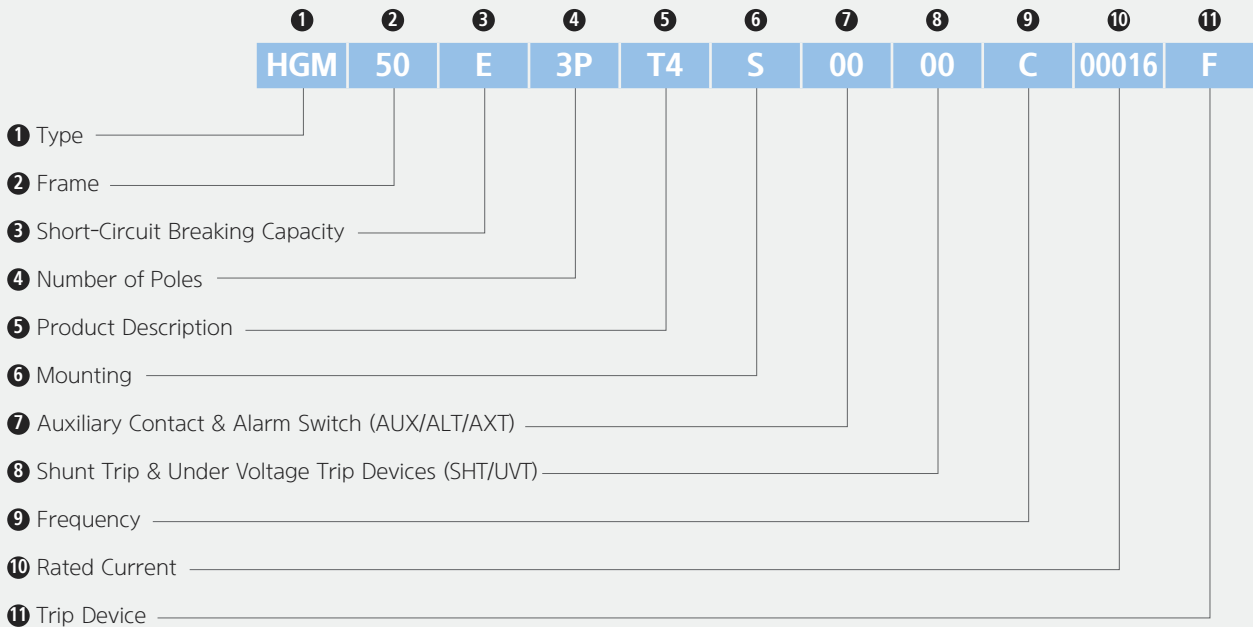

1 Type	
HGM	Molded Case Circuit Breakers
HGE	Earth Leakage Circuit Breakers
2 Frame	
30	32 AF
50	50 AF
60	63 AF
100	100 AF
125	125 AF
160	160 AF
250	250 AF
400	400 AF
630	630 AF
800	800 AF
3 Short-Circuit Breaking Capacity	
E	E Type
S	S Type
H	H Type
L	L Type

4 Number of Poles	
Normal type MCCB/ELCB	
2P	2 Pole
3P	3 Pole
4P	4 Pole (RSTN)
4PN	4 Pole (NRST)
ZCT MCCB	
2Z	2 Pole
3Z	3 Pole
4Z	4 Pole
5 Product Description	
MCCB: Ambient temperature	
T4	40/45 °C
T5	50 °C
ELCB: Rated residual current	
G4	30 mA
G5 ¹⁾	100 mA

6 Mounting	
S	Front connection
BS ²⁾	Terminal busbar (Straight type)
BE ³⁾	Terminal busbar (Extended type)
P	Plug-in
F	Line: Plug-in Load: Front connection
X	PC/CBM Non-attachment
7 Auxiliary Contact & Alarm Switch (AUX/ALT/AXT)	
00	Non-attachment
10	AUX 1C
20	AUX 2C
01	ALT 1C
11	AUX 1C + ALT 1C
21	AUX 2C + ALT 1C

8 Shunt Trip & Under Voltage Trip Devices (SHT/UVT)	
00	Non-attachment
S1	SHT AC100 - 120 V
S2	SHT AC200 - 230 V
S3 ⁴⁾	SHT AC380 - 415 V
S4 ⁴⁾	SHT AC440 - 480 V
S5	SHT DC24 V
S6	SHT DC100 - 125 V
S7 ⁵⁾	SHT DC48 V
S8 ⁵⁾	SHT DC60 V
U1	UVT AC100 - 120 V
U2	UVT AC200 - 230 V
U3	UVT AC380 - 415 V
U4	UVT AC440 - 480 V
U5	UVT DC24 V
U6	UVT DC100 - 125 V
U7 ⁵⁾	UVT DC48 V
9 Frequency	
C	50/60 Hz in common
10 Rated Current	
00016	16 A
00020	20 A
	⋮
00800	800 A
11 Trip Device	
-	Fixed thermal/ Fixed instantaneous
F	Adjustable thermal/ Fixed instantaneous



※ **1)** 100/300/500/1,000 mA adjustable In case of time delay type, please order at 100 mA.
2) Exclusive for 400 - 800 AF.
3) Exclusive for 400 AF.
4) HGM32 - 250 AF has AC380 - 480 V.
5) Exclusive for HGM32 - 250 AF.

Ordering Codes

HGM Type Molded Case Circuit Breakers (MCCB)

- Normal type/Front connection
- Except for accessory, Based on ambient temperature 40 °C and frequency 50/60 Hz

Adjustable (Thermal Adjustable / Instantaneous Fixing)

32 AF	In	2 Pole	3 Pole	4 Pole (RSTN)	4 Pole (NRST)
	HGM30E...16 kA / 460 V				
	16 A	HGM30E 2PT4S0000C 00016F	HGM30E 3PT4S0000C 00016F	HGM30E 4PT4S0000C 00016F	HGM30E 4PNT4S0000C 00016F
	20 A	HGM30E 2PT4S0000C 00020F	HGM30E 3PT4S0000C 00020F	HGM30E 4PT4S0000C 00020F	HGM30E 4PNT4S0000C 00020F
	25 A	HGM30E 2PT4S0000C 00025F	HGM30E 3PT4S0000C 00025F	HGM30E 4PT4S0000C 00025F	HGM30E 4PNT4S0000C 00025F
	32 A	HGM30E 2PT4S0000C 00032F	HGM30E 3PT4S0000C 00032F	HGM30E 4PT4S0000C 00032F	HGM30E 4PNT4S0000C 00032F
	HGM30S...20 kA / 460 V				
	16 A	HGM30S 2PT4S0000C 00016F	HGM30S 3PT4S0000C 00016F	HGM30S 4PT4S0000C 00016F	HGM30S 4PNT4S0000C 00016F
	20 A	HGM30S 2PT4S0000C 00020F	HGM30S 3PT4S0000C 00020F	HGM30S 4PT4S0000C 00020F	HGM30S 4PNT4S0000C 00020F
	25 A	HGM30S 2PT4S0000C 00025F	HGM30S 3PT4S0000C 00025F	HGM30S 4PT4S0000C 00025F	HGM30S 4PNT4S0000C 00025F
	32 A	HGM30S 2PT4S0000C 00032F	HGM30S 3PT4S0000C 00032F	HGM30S 4PT4S0000C 00032F	HGM30S 4PNT4S0000C 00032F
	HGM50E...16 kA / 460 V				
		16 A	HGM50E 2PT4S0000C 00016F	HGM50E 3PT4S0000C 00016F	HGM50E 4PT4S0000C 00016F
20 A		HGM50E 2PT4S0000C 00020F	HGM50E 3PT4S0000C 00020F	HGM50E 4PT4S0000C 00020F	HGM50E 4PNT4S0000C 00020F
25 A		HGM50E 2PT4S0000C 00025F	HGM50E 3PT4S0000C 00025F	HGM50E 4PT4S0000C 00025F	HGM50E 4PNT4S0000C 00025F
32 A		HGM50E 2PT4S0000C 00032F	HGM50E 3PT4S0000C 00032F	HGM50E 4PT4S0000C 00032F	HGM50E 4PNT4S0000C 00032F
40 A		HGM50E 2PT4S0000C 00040F	HGM50E 3PT4S0000C 00040F	HGM50E 4PT4S0000C 00040F	HGM50E 4PNT4S0000C 00040F
50 A		HGM50E 2PT4S0000C 00050F	HGM50E 3PT4S0000C 00050F	HGM50E 4PT4S0000C 00050F	HGM50E 4PNT4S0000C 00050F
HGM50S...20 kA / 460 V					
16 A		HGM50S 2PT4S0000C 00016F	HGM50S 3PT4S0000C 00016F	HGM50S 4PT4S0000C 00016F	HGM50S 4PNT4S0000C 00016F
20 A		HGM50S 2PT4S0000C 00020F	HGM50S 3PT4S0000C 00020F	HGM50S 4PT4S0000C 00020F	HGM50S 4PNT4S0000C 00020F
25 A		HGM50S 2PT4S0000C 00025F	HGM50S 3PT4S0000C 00025F	HGM50S 4PT4S0000C 00025F	HGM50S 4PNT4S0000C 00025F
32 A		HGM50S 2PT4S0000C 00032F	HGM50S 3PT4S0000C 00032F	HGM50S 4PT4S0000C 00032F	HGM50S 4PNT4S0000C 00032F
40 A		HGM50S 2PT4S0000C 00040F	HGM50S 3PT4S0000C 00040F	HGM50S 4PT4S0000C 00040F	HGM50S 4PNT4S0000C 00040F
50 A	HGM50S 2PT4S0000C 00050F	HGM50S 3PT4S0000C 00050F	HGM50S 4PT4S0000C 00050F	HGM50S 4PNT4S0000C 00050F	
HGM50H...38 kA / 460 V					
16 A	HGM50H 2PT4S0000C 00016F	HGM50H 3PT4S0000C 00016F	HGM50H 4PT4S0000C 00016F	HGM50H 4PNT4S0000C 00016F	
20 A	HGM50H 2PT4S0000C 00020F	HGM50H 3PT4S0000C 00020F	HGM50H 4PT4S0000C 00020F	HGM50H 4PNT4S0000C 00020F	
25 A	HGM50H 2PT4S0000C 00025F	HGM50H 3PT4S0000C 00025F	HGM50H 4PT4S0000C 00025F	HGM50H 4PNT4S0000C 00025F	
32 A	HGM50H 2PT4S0000C 00032F	HGM50H 3PT4S0000C 00032F	HGM50H 4PT4S0000C 00032F	HGM50H 4PNT4S0000C 00032F	
40 A	HGM50H 2PT4S0000C 00040F	HGM50H 3PT4S0000C 00040F	HGM50H 4PT4S0000C 00040F	HGM50H 4PNT4S0000C 00040F	
50 A	HGM50H 2PT4S0000C 00050F	HGM50H 3PT4S0000C 00050F	HGM50H 4PT4S0000C 00050F	HGM50H 4PNT4S0000C 00050F	
HGM50L...55 kA / 460 V					
16 A	HGM50L 2PT4S0000C 00016F	HGM50L 3PT4S0000C 00016F	HGM50L 4PT4S0000C 00016F	HGM50L 4PNT4S0000C 00016F	
20 A	HGM50L 2PT4S0000C 00020F	HGM50L 3PT4S0000C 00020F	HGM50L 4PT4S0000C 00020F	HGM50L 4PNT4S0000C 00020F	
25 A	HGM50L 2PT4S0000C 00025F	HGM50L 3PT4S0000C 00025F	HGM50L 4PT4S0000C 00025F	HGM50L 4PNT4S0000C 00025F	
32 A	HGM50L 2PT4S0000C 00032F	HGM50L 3PT4S0000C 00032F	HGM50L 4PT4S0000C 00032F	HGM50L 4PNT4S0000C 00032F	
40 A	HGM50L 2PT4S0000C 00040F	HGM50L 3PT4S0000C 00040F	HGM50L 4PT4S0000C 00040F	HGM50L 4PNT4S0000C 00040F	
50 A	HGM50L 2PT4S0000C 00050F	HGM50L 3PT4S0000C 00050F	HGM50L 4PT4S0000C 00050F	HGM50L 4PNT4S0000C 00050F	

Ordering Codes

HGM Type Molded Case Circuit Breakers (MCCB)

- Normal type/Front connection
- Except for accessory, Based on ambient temperature 40 °C and frequency 50/60 Hz

Adjustable (Thermal Adjustable / Instantaneous Fixing)

63 AF	In	2 Pole	3 Pole	4 Pole (RSTN)	4 Pole (NRST)
	HGM60E...16 kA / 460 V				
	16 A	HGM60E 2PT4S0000C 00016F	HGM60E 3PT4S0000C 00016F	HGM60E 4PT4S0000C 00016F	HGM60E 4PNT4S0000C 00016F
	20 A	HGM60E 2PT4S0000C 00020F	HGM60E 3PT4S0000C 00020F	HGM60E 4PT4S0000C 00020F	HGM60E 4PNT4S0000C 00020F
	25 A	HGM60E 2PT4S0000C 00025F	HGM60E 3PT4S0000C 00025F	HGM60E 4PT4S0000C 00025F	HGM60E 4PNT4S0000C 00025F
	32 A	HGM60E 2PT4S0000C 00032F	HGM60E 3PT4S0000C 00032F	HGM60E 4PT4S0000C 00032F	HGM60E 4PNT4S0000C 00032F
	40 A	HGM60E 2PT4S0000C 00040F	HGM60E 3PT4S0000C 00040F	HGM60E 4PT4S0000C 00040F	HGM60E 4PNT4S0000C 00040F
	50 A	HGM60E 2PT4S0000C 00050F	HGM60E 3PT4S0000C 00050F	HGM60E 4PT4S0000C 00050F	HGM60E 4PNT4S0000C 00050F
	63 A	HGM60E 2PT4S0000C 00063F	HGM60E 3PT4S0000C 00063F	HGM60E 4PT4S0000C 00063F	HGM60E 4PNT4S0000C 00063F
	HGM60S...20 kA / 460 V				
	16 A	HGM60S 2PT4S0000C 00016F	HGM60S 3PT4S0000C 00016F	HGM60S 4PT4S0000C 00016F	HGM60S 4PNT4S0000C 00016F
	20 A	HGM60S 2PT4S0000C 00020F	HGM60S 3PT4S0000C 00020F	HGM60S 4PT4S0000C 00020F	HGM60S 4PNT4S0000C 00020F
	25 A	HGM60S 2PT4S0000C 00025F	HGM60S 3PT4S0000C 00025F	HGM60S 4PT4S0000C 00025F	HGM60S 4PNT4S0000C 00025F
	32 A	HGM60S 2PT4S0000C 00032F	HGM60S 3PT4S0000C 00032F	HGM60S 4PT4S0000C 00032F	HGM60S 4PNT4S0000C 00032F
	40 A	HGM60S 2PT4S0000C 00040F	HGM60S 3PT4S0000C 00040F	HGM60S 4PT4S0000C 00040F	HGM60S 4PNT4S0000C 00040F
50 A	HGM60S 2PT4S0000C 00050F	HGM60S 3PT4S0000C 00050F	HGM60S 4PT4S0000C 00050F	HGM60S 4PNT4S0000C 00050F	
63 A	HGM60S 2PT4S0000C 00063F	HGM60S 3PT4S0000C 00063F	HGM60S 4PT4S0000C 00063F	HGM60S 4PNT4S0000C 00063F	
HGM60H...26 kA / 460 V					
16 A	HGM60H 2PT4S0000C 00016F	HGM60H 3PT4S0000C 00016F	HGM60H 4PT4S0000C 00016F	HGM60H 4PNT4S0000C 00016F	
20 A	HGM60H 2PT4S0000C 00020F	HGM60H 3PT4S0000C 00020F	HGM60H 4PT4S0000C 00020F	HGM60H 4PNT4S0000C 00020F	
25 A	HGM60H 2PT4S0000C 00025F	HGM60H 3PT4S0000C 00025F	HGM60H 4PT4S0000C 00025F	HGM60H 4PNT4S0000C 00025F	
32 A	HGM60H 2PT4S0000C 00032F	HGM60H 3PT4S0000C 00032F	HGM60H 4PT4S0000C 00032F	HGM60H 4PNT4S0000C 00032F	
40 A	HGM60H 2PT4S0000C 00040F	HGM60H 3PT4S0000C 00040F	HGM60H 4PT4S0000C 00040F	HGM60H 4PNT4S0000C 00040F	
50 A	HGM60H 2PT4S0000C 00050F	HGM60H 3PT4S0000C 00050F	HGM60H 4PT4S0000C 00050F	HGM60H 4PNT4S0000C 00050F	
63 A	HGM60H 2PT4S0000C 00063F	HGM60H 3PT4S0000C 00063F	HGM60H 4PT4S0000C 00063F	HGM60H 4PNT4S0000C 00063F	
HGM60L...30 kA / 460 V					
16 A	HGM60L 2PT4S0000C 00016F	HGM60L 3PT4S0000C 00016F	HGM60L 4PT4S0000C 00016F	HGM60L 4PNT4S0000C 00016F	
20 A	HGM60L 2PT4S0000C 00020F	HGM60L 3PT4S0000C 00020F	HGM60L 4PT4S0000C 00020F	HGM60L 4PNT4S0000C 00020F	
25 A	HGM60L 2PT4S0000C 00025F	HGM60L 3PT4S0000C 00025F	HGM60L 4PT4S0000C 00025F	HGM60L 4PNT4S0000C 00025F	
32 A	HGM60L 2PT4S0000C 00032F	HGM60L 3PT4S0000C 00032F	HGM60L 4PT4S0000C 00032F	HGM60L 4PNT4S0000C 00032F	
40 A	HGM60L 2PT4S0000C 00040F	HGM60L 3PT4S0000C 00040F	HGM60L 4PT4S0000C 00040F	HGM60L 4PNT4S0000C 00040F	
50 A	HGM60L 2PT4S0000C 00050F	HGM60L 3PT4S0000C 00050F	HGM60L 4PT4S0000C 00050F	HGM60L 4PNT4S0000C 00050F	
63 A	HGM60L 2PT4S0000C 00063F	HGM60L 3PT4S0000C 00063F	HGM60L 4PT4S0000C 00063F	HGM60L 4PNT4S0000C 00063F	

100 AF	In	2 Pole	3 Pole	4 Pole (RSTN)	4 Pole (NRST)
	HGM100E...16 kA / 460 V				
	16 A	HGM100E 2PT4S0000C 00016F	HGM100E 3PT4S0000C 00016F	HGM100E 4PT4S0000C 00016F	HGM100E 4PNT4S0000C 00016F
	20 A	HGM100E 2PT4S0000C 00020F	HGM100E 3PT4S0000C 00020F	HGM100E 4PT4S0000C 00020F	HGM100E 4PNT4S0000C 00020F
	25 A	HGM100E 2PT4S0000C 00025F	HGM100E 3PT4S0000C 00025F	HGM100E 4PT4S0000C 00025F	HGM100E 4PNT4S0000C 00025F
	32 A	HGM100E 2PT4S0000C 00032F	HGM100E 3PT4S0000C 00032F	HGM100E 4PT4S0000C 00032F	HGM100E 4PNT4S0000C 00032F
	40 A	HGM100E 2PT4S0000C 00040F	HGM100E 3PT4S0000C 00040F	HGM100E 4PT4S0000C 00040F	HGM100E 4PNT4S0000C 00040F
	50 A	HGM100E 2PT4S0000C 00050F	HGM100E 3PT4S0000C 00050F	HGM100E 4PT4S0000C 00050F	HGM100E 4PNT4S0000C 00050F
	63 A	HGM100E 2PT4S0000C 00063F	HGM100E 3PT4S0000C 00063F	HGM100E 4PT4S0000C 00063F	HGM100E 4PNT4S0000C 00063F
	75 A	HGM100E 2PT4S0000C 00075F	HGM100E 3PT4S0000C 00075F	HGM100E 4PT4S0000C 00075F	HGM100E 4PNT4S0000C 00075F
	80 A	HGM100E 2PT4S0000C 00080F	HGM100E 3PT4S0000C 00080F	HGM100E 4PT4S0000C 00080F	HGM100E 4PNT4S0000C 00080F
	100 A	HGM100E 2PT4S0000C 00100F	HGM100E 3PT4S0000C 00100F	HGM100E 4PT4S0000C 00100F	HGM100E 4PNT4S0000C 00100F

Ordering Codes

HGM Type Molded Case Circuit Breakers (MCCB)

- Normal type/Front connection
- Except for accessory, Based on ambient temperature 40 °C and frequency 50/60 Hz

Adjustable (Thermal Adjustable / Instantaneous Fixing)

125 AF	In	2 Pole	3 Pole	4 Pole (RSTN)	4 Pole (NRST)	
	HGM125S...26 kA / 460 V					
	16 A	HGM125S 2PT4S0000C 00016F	HGM125S 3PT4S0000C 00016F	HGM125S 4PT4S0000C 00016F	HGM125S 4PNT4S0000C 00016F	
	20 A	HGM125S 2PT4S0000C 00020F	HGM125S 3PT4S0000C 00020F	HGM125S 4PT4S0000C 00020F	HGM125S 4PNT4S0000C 00020F	
	25 A	HGM125S 2PT4S0000C 00025F	HGM125S 3PT4S0000C 00025F	HGM125S 4PT4S0000C 00025F	HGM125S 4PNT4S0000C 00025F	
	32 A	HGM125S 2PT4S0000C 00032F	HGM125S 3PT4S0000C 00032F	HGM125S 4PT4S0000C 00032F	HGM125S 4PNT4S0000C 00032F	
	40 A	HGM125S 2PT4S0000C 00040F	HGM125S 3PT4S0000C 00040F	HGM125S 4PT4S0000C 00040F	HGM125S 4PNT4S0000C 00040F	
	50 A	HGM125S 2PT4S0000C 00050F	HGM125S 3PT4S0000C 00050F	HGM125S 4PT4S0000C 00050F	HGM125S 4PNT4S0000C 00050F	
	63 A	HGM125S 2PT4S0000C 00063F	HGM125S 3PT4S0000C 00063F	HGM125S 4PT4S0000C 00063F	HGM125S 4PNT4S0000C 00063F	
	75 A	HGM125S 2PT4S0000C 00075F	HGM125S 3PT4S0000C 00075F	HGM125S 4PT4S0000C 00075F	HGM125S 4PNT4S0000C 00075F	
	80 A	HGM125S 2PT4S0000C 00080F	HGM125S 3PT4S0000C 00080F	HGM125S 4PT4S0000C 00080F	HGM125S 4PNT4S0000C 00080F	
	100 A	HGM125S 2PT4S0000C 00100F	HGM125S 3PT4S0000C 00100F	HGM125S 4PT4S0000C 00100F	HGM125S 4PNT4S0000C 00100F	
	125 A	HGM125S 2PT4S0000C 00125F	HGM125S 3PT4S0000C 00125F	HGM125S 4PT4S0000C 00125F	HGM125S 4PNT4S0000C 00125F	
	HGM125H...38 kA / 460 V					
	16 A	HGM125H 2PT4S0000C 00016F	HGM125H 3PT4S0000C 00016F	HGM125H 4PT4S0000C 00016F	HGM125H 4PNT4S0000C 00016F	
	20 A	HGM125H 2PT4S0000C 00020F	HGM125H 3PT4S0000C 00020F	HGM125H 4PT4S0000C 00020F	HGM125H 4PNT4S0000C 00020F	
	25 A	HGM125H 2PT4S0000C 00025F	HGM125H 3PT4S0000C 00025F	HGM125H 4PT4S0000C 00025F	HGM125H 4PNT4S0000C 00025F	
32 A	HGM125H 2PT4S0000C 00032F	HGM125H 3PT4S0000C 00032F	HGM125H 4PT4S0000C 00032F	HGM125H 4PNT4S0000C 00032F		
40 A	HGM125H 2PT4S0000C 00040F	HGM125H 3PT4S0000C 00040F	HGM125H 4PT4S0000C 00040F	HGM125H 4PNT4S0000C 00040F		
50 A	HGM125H 2PT4S0000C 00050F	HGM125H 3PT4S0000C 00050F	HGM125H 4PT4S0000C 00050F	HGM125H 4PNT4S0000C 00050F		
63 A	HGM125H 2PT4S0000C 00063F	HGM125H 3PT4S0000C 00063F	HGM125H 4PT4S0000C 00063F	HGM125H 4PNT4S0000C 00063F		
75 A	HGM125H 2PT4S0000C 00075F	HGM125H 3PT4S0000C 00075F	HGM125H 4PT4S0000C 00075F	HGM125H 4PNT4S0000C 00075F		
80 A	HGM125H 2PT4S0000C 00080F	HGM125H 3PT4S0000C 00080F	HGM125H 4PT4S0000C 00080F	HGM125H 4PNT4S0000C 00080F		
100 A	HGM125H 2PT4S0000C 00100F	HGM125H 3PT4S0000C 00100F	HGM125H 4PT4S0000C 00100F	HGM125H 4PNT4S0000C 00100F		
125 A	HGM125H 2PT4S0000C 00125F	HGM125H 3PT4S0000C 00125F	HGM125H 4PT4S0000C 00125F	HGM125H 4PNT4S0000C 00125F		
HGM125L...55 kA / 460 V						
16 A	HGM125L 2PT4S0000C 00016F	HGM125L 3PT4S0000C 00016F	HGM125L 4PT4S0000C 00016F	HGM125L 4PNT4S0000C 00016F		
20 A	HGM125L 2PT4S0000C 00020F	HGM125L 3PT4S0000C 00020F	HGM125L 4PT4S0000C 00020F	HGM125L 4PNT4S0000C 00020F		
25 A	HGM125L 2PT4S0000C 00025F	HGM125L 3PT4S0000C 00025F	HGM125L 4PT4S0000C 00025F	HGM125L 4PNT4S0000C 00025F		
32 A	HGM125L 2PT4S0000C 00032F	HGM125L 3PT4S0000C 00032F	HGM125L 4PT4S0000C 00032F	HGM125L 4PNT4S0000C 00032F		
40 A	HGM125L 2PT4S0000C 00040F	HGM125L 3PT4S0000C 00040F	HGM125L 4PT4S0000C 00040F	HGM125L 4PNT4S0000C 00040F		
50 A	HGM125L 2PT4S0000C 00050F	HGM125L 3PT4S0000C 00050F	HGM125L 4PT4S0000C 00050F	HGM125L 4PNT4S0000C 00050F		
63 A	HGM125L 2PT4S0000C 00063F	HGM125L 3PT4S0000C 00063F	HGM125L 4PT4S0000C 00063F	HGM125L 4PNT4S0000C 00063F		
75 A	HGM125L 2PT4S0000C 00075F	HGM125L 3PT4S0000C 00075F	HGM125L 4PT4S0000C 00075F	HGM125L 4PNT4S0000C 00075F		
80 A	HGM125L 2PT4S0000C 00080F	HGM125L 3PT4S0000C 00080F	HGM125L 4PT4S0000C 00080F	HGM125L 4PNT4S0000C 00080F		
100 A	HGM125L 2PT4S0000C 00100F	HGM125L 3PT4S0000C 00100F	HGM125L 4PT4S0000C 00100F	HGM125L 4PNT4S0000C 00100F		
125 A	HGM125L 2PT4S0000C 00125F	HGM125L 3PT4S0000C 00125F	HGM125L 4PT4S0000C 00125F	HGM125L 4PNT4S0000C 00125F		

160 AF	In	2 Pole	3 Pole	4 Pole (RSTN)	4 Pole (NRST)
	HGM160E...20 kA / 460 V				
	100 A	HGM160E 2PT4S0000C 00100F	HGM160E 3PT4S0000C 00100F	HGM160E 4PT4S0000C 00100F	HGM160E 4PNT4S0000C 00100F
	125 A	HGM160E 2PT4S0000C 00125F	HGM160E 3PT4S0000C 00125F	HGM160E 4PT4S0000C 00125F	HGM160E 4PNT4S0000C 00125F
	150 A	HGM160E 2PT4S0000C 00150F	HGM160E 3PT4S0000C 00150F	HGM160E 4PT4S0000C 00150F	HGM160E 4PNT4S0000C 00150F
	160 A	HGM160E 2PT4S0000C 00160F	HGM160E 3PT4S0000C 00160F	HGM160E 4PT4S0000C 00160F	HGM160E 4PNT4S0000C 00160F
	HGM160S...26 kA / 460 V				
100 A	HGM160S 2PT4S0000C 00100F	HGM160S 3PT4S0000C 00100F	HGM160S 4PT4S0000C 00100F	HGM160S 4PNT4S0000C 00100F	
125 A	HGM160S 2PT4S0000C 00125F	HGM160S 3PT4S0000C 00125F	HGM160S 4PT4S0000C 00125F	HGM160S 4PNT4S0000C 00125F	
150 A	HGM160S 2PT4S0000C 00150F	HGM160S 3PT4S0000C 00150F	HGM160S 4PT4S0000C 00150F	HGM160S 4PNT4S0000C 00150F	
160 A	HGM160S 2PT4S0000C 00160F	HGM160S 3PT4S0000C 00160F	HGM160S 4PT4S0000C 00160F	HGM160S 4PNT4S0000C 00160F	

Ordering Codes

HGM Type Molded Case Circuit Breakers (MCCB)

- Normal type/Front connection
- Except for accessory, Based on ambient temperature 40 °C and frequency 50/60 Hz

Adjustable (Thermal Adjustable / Instantaneous Fixing)

400 AF	In	2 Pole	3 Pole	4 Pole (RSTN)	4 Pole (NRST)
	HGM400E...38 kA / 460 V				
	250 A	HGM400E 2PT4S0000C 00250F	HGM400E 3PT4S0000C 00250F	HGM400E 4PT4S0000C 00250F	HGM400E 4PNT4S0000C 00250F
	300 A	HGM400E 2PT4S0000C 00300F	HGM400E 3PT4S0000C 00300F	HGM400E 4PT4S0000C 00300F	HGM400E 4PNT4S0000C 00300F
	350 A	HGM400E 2PT4S0000C 00350F	HGM400E 3PT4S0000C 00350F	HGM400E 4PT4S0000C 00350F	HGM400E 4PNT4S0000C 00350F
	400 A	HGM400E 2PT4S0000C 00400F	HGM400E 3PT4S0000C 00400F	HGM400E 4PT4S0000C 00400F	HGM400E 4PNT4S0000C 00400F
	HGM400S...50 kA / 460 V				
	250 A	HGM400S 2PT4S0000C 00250F	HGM400S 3PT4S0000C 00250F	HGM400S 4PT4S0000C 00250F	HGM400S 4PNT4S0000C 00250F
	300 A	HGM400S 2PT4S0000C 00300F	HGM400S 3PT4S0000C 00300F	HGM400S 4PT4S0000C 00300F	HGM400S 4PNT4S0000C 00300F
	350 A	HGM400S 2PT4S0000C 00350F	HGM400S 3PT4S0000C 00350F	HGM400S 4PT4S0000C 00350F	HGM400S 4PNT4S0000C 00350F
	400 A	HGM400S 2PT4S0000C 00400F	HGM400S 3PT4S0000C 00400F	HGM400S 4PT4S0000C 00400F	HGM400S 4PNT4S0000C 00400F
	HGM400H...70 kA / 460 V				
	250 A	HGM400H 2PT4S0000C 00250F	HGM400H 3PT4S0000C 00250F	HGM400H 4PT4S0000C 00250F	HGM400H 4PNT4S0000C 00250F
	300 A	HGM400H 2PT4S0000C 00300F	HGM400H 3PT4S0000C 00300F	HGM400H 4PT4S0000C 00300F	HGM400H 4PNT4S0000C 00300F
	350 A	HGM400H 2PT4S0000C 00350F	HGM400H 3PT4S0000C 00350F	HGM400H 4PT4S0000C 00350F	HGM400H 4PNT4S0000C 00350F
	400 A	HGM400H 2PT4S0000C 00400F	HGM400H 3PT4S0000C 00400F	HGM400H 4PT4S0000C 00400F	HGM400H 4PNT4S0000C 00400F
	HGM400L...85 kA / 460 V				
250 A	HGM400L 2PT4S0000C 00250F	HGM400L 3PT4S0000C 00250F	HGM400L 4PT4S0000C 00250F	HGM400L 4PNT4S0000C 00250F	
300 A	HGM400L 2PT4S0000C 00300F	HGM400L 3PT4S0000C 00300F	HGM400L 4PT4S0000C 00300F	HGM400L 4PNT4S0000C 00300F	
350 A	HGM400L 2PT4S0000C 00350F	HGM400L 3PT4S0000C 00350F	HGM400L 4PT4S0000C 00350F	HGM400L 4PNT4S0000C 00350F	
400 A	HGM400L 2PT4S0000C 00400F	HGM400L 3PT4S0000C 00400F	HGM400L 4PT4S0000C 00400F	HGM400L 4PNT4S0000C 00400F	

630 AF	In	2 Pole	3 Pole	4 Pole (RSTN)	4 Pole (NRST)
	HGM630E...38 kA / 460 V				
	500 A	HGM630E 2PT4S0000C 00500F	HGM630E 3PT4S0000C 00500F	HGM630E 4PT4S0000C 00500F	HGM630E 4PNT4S0000C 00500F
	630 A	HGM630E 2PT4S0000C 00630F	HGM630E 3PT4S0000C 00630F	HGM630E 4PT4S0000C 00630F	HGM630E 4PNT4S0000C 00630F
	HGM630S...50 kA / 460 V				
	500 A	HGM630S 2PT4S0000C 00500F	HGM630S 3PT4S0000C 00500F	HGM630S 4PT4S0000C 00500F	HGM630S 4PNT4S0000C 00500F
	630 A	HGM630S 2PT4S0000C 00630F	HGM630S 3PT4S0000C 00630F	HGM630S 4PT4S0000C 00630F	HGM630S 4PNT4S0000C 00630F
	HGM630H...70 kA / 460 V				
	500 A	HGM630H 2PT4S0000C 00500F	HGM630H 3PT4S0000C 00500F	HGM630H 4PT4S0000C 00500F	HGM630H 4PNT4S0000C 00500F
	630 A	HGM630H 2PT4S0000C 00630F	HGM630H 3PT4S0000C 00630F	HGM630H 4PT4S0000C 00630F	HGM630H 4PNT4S0000C 00630F
	HGM630L...85 kA / 460 V				
	500 A	HGM630L 2PT4S0000C 00500F	HGM630L 3PT4S0000C 00500F	HGM630L 4PT4S0000C 00500F	HGM630L 4PNT4S0000C 00500F
	630 A	HGM630L 2PT4S0000C 00630F	HGM630L 3PT4S0000C 00630F	HGM630L 4PT4S0000C 00630F	HGM630L 4PNT4S0000C 00630F

800 AF	In	2 Pole	3 Pole	4 Pole (RSTN)	4 Pole (NRST)
	HGM800S...50 kA / 460 V				
	700 A	HGM800S 2PT4S0000C 00700F	HGM800S 3PT4S0000C 00700F	HGM800S 4PT4S0000C 00700F	HGM800S 4PNT4S0000C 00700F
	800 A	HGM800S 2PT4S0000C 00800F	HGM800S 3PT4S0000C 00800F	HGM800S 4PT4S0000C 00800F	HGM800S 4PNT4S0000C 00800F
	HGM800H...70 kA / 460 V				
	700 A	HGM800H 2PT4S0000C 00700F	HGM800H 3PT4S0000C 00700F	HGM800H 4PT4S0000C 00700F	HGM800H 4PNT4S0000C 00700F
	800 A	HGM800H 2PT4S0000C 00800F	HGM800H 3PT4S0000C 00800F	HGM800H 4PT4S0000C 00800F	HGM800H 4PNT4S0000C 00800F
	HGM800L...85 kA / 460 V				
	700 A	HGM800L 2PT4S0000C 00700F	HGM800L 3PT4S0000C 00700F	HGM800L 4PT4S0000C 00700F	HGM800L 4PNT4S0000C 00700F
	800 A	HGM800L 2PT4S0000C 00800F	HGM800L 3PT4S0000C 00800F	HGM800L 4PT4S0000C 00800F	HGM800L 4PNT4S0000C 00800F

Fixing (Thermal Fixing / Instantaneous Fixing)

32 AF	In	2 Pole	3 Pole	4 Pole (RSTN)	4 Pole (NRST)
	HGM30E...16 kA / 460 V				
	16 A	HGM30E 2PT4S0000C 00016	HGM30E 3PT4S0000C 00016	HGM30E 4PT4S0000C 00016	HGM30E 4PNT4S0000C 00016
	20 A	HGM30E 2PT4S0000C 00020	HGM30E 3PT4S0000C 00020	HGM30E 4PT4S0000C 00020	HGM30E 4PNT4S0000C 00020
	25 A	HGM30E 2PT4S0000C 00025	HGM30E 3PT4S0000C 00025	HGM30E 4PT4S0000C 00025	HGM30E 4PNT4S0000C 00025
	32 A	HGM30E 2PT4S0000C 00032	HGM30E 3PT4S0000C 00032	HGM30E 4PT4S0000C 00032	HGM30E 4PNT4S0000C 00032
	HGM30S...20 kA / 460 V				
	16 A	HGM30S 2PT4S0000C 00016	HGM30S 3PT4S0000C 00016	HGM30S 4PT4S0000C 00016	HGM30S 4PNT4S0000C 00016
	20 A	HGM30S 2PT4S0000C 00020	HGM30S 3PT4S0000C 00020	HGM30S 4PT4S0000C 00020	HGM30S 4PNT4S0000C 00020
	25 A	HGM30S 2PT4S0000C 00025	HGM30S 3PT4S0000C 00025	HGM30S 4PT4S0000C 00025	HGM30S 4PNT4S0000C 00025
	32 A	HGM30S 2PT4S0000C 00032	HGM30S 3PT4S0000C 00032	HGM30S 4PT4S0000C 00032	HGM30S 4PNT4S0000C 00032
	HGM50E...16 kA / 460 V				
	16 A	HGM50E 2PT4S0000C 00016	HGM50E 3PT4S0000C 00016	HGM50E 4PT4S0000C 00016	HGM50E 4PNT4S0000C 00016
	20 A	HGM50E 2PT4S0000C 00020	HGM50E 3PT4S0000C 00020	HGM50E 4PT4S0000C 00020	HGM50E 4PNT4S0000C 00020
	25 A	HGM50E 2PT4S0000C 00025	HGM50E 3PT4S0000C 00025	HGM50E 4PT4S0000C 00025	HGM50E 4PNT4S0000C 00025
32 A	HGM50E 2PT4S0000C 00032	HGM50E 3PT4S0000C 00032	HGM50E 4PT4S0000C 00032	HGM50E 4PNT4S0000C 00032	
40 A	HGM50E 2PT4S0000C 00040	HGM50E 3PT4S0000C 00040	HGM50E 4PT4S0000C 00040	HGM50E 4PNT4S0000C 00040	
50 A	HGM50E 2PT4S0000C 00050	HGM50E 3PT4S0000C 00050	HGM50E 4PT4S0000C 00050	HGM50E 4PNT4S0000C 00050	
HGM50S...20 kA / 460 V					
16 A	HGM50S 2PT4S0000C 00016	HGM50S 3PT4S0000C 00016	HGM50S 4PT4S0000C 00016	HGM50S 4PNT4S0000C 00016	
20 A	HGM50S 2PT4S0000C 00020	HGM50S 3PT4S0000C 00020	HGM50S 4PT4S0000C 00020	HGM50S 4PNT4S0000C 00020	
25 A	HGM50S 2PT4S0000C 00025	HGM50S 3PT4S0000C 00025	HGM50S 4PT4S0000C 00025	HGM50S 4PNT4S0000C 00025	
32 A	HGM50S 2PT4S0000C 00032	HGM50S 3PT4S0000C 00032	HGM50S 4PT4S0000C 00032	HGM50S 4PNT4S0000C 00032	
40 A	HGM50S 2PT4S0000C 00040	HGM50S 3PT4S0000C 00040	HGM50S 4PT4S0000C 00040	HGM50S 4PNT4S0000C 00040	
50 A	HGM50S 2PT4S0000C 00050	HGM50S 3PT4S0000C 00050	HGM50S 4PT4S0000C 00050	HGM50S 4PNT4S0000C 00050	
HGM50H...38 kA / 460 V					
16 A	HGM50H 2PT4S0000C 00016	HGM50H 3PT4S0000C 00016	HGM50H 4PT4S0000C 00016	HGM50H 4PNT4S0000C 00016	
20 A	HGM50H 2PT4S0000C 00020	HGM50H 3PT4S0000C 00020	HGM50H 4PT4S0000C 00020	HGM50H 4PNT4S0000C 00020	
25 A	HGM50H 2PT4S0000C 00025	HGM50H 3PT4S0000C 00025	HGM50H 4PT4S0000C 00025	HGM50H 4PNT4S0000C 00025	
32 A	HGM50H 2PT4S0000C 00032	HGM50H 3PT4S0000C 00032	HGM50H 4PT4S0000C 00032	HGM50H 4PNT4S0000C 00032	
40 A	HGM50H 2PT4S0000C 00040	HGM50H 3PT4S0000C 00040	HGM50H 4PT4S0000C 00040	HGM50H 4PNT4S0000C 00040	
50 A	HGM50H 2PT4S0000C 00050	HGM50H 3PT4S0000C 00050	HGM50H 4PT4S0000C 00050	HGM50H 4PNT4S0000C 00050	
HGM50L...55 kA / 460 V					
16 A	HGM50L 2PT4S0000C 00016	HGM50L 3PT4S0000C 00016	HGM50L 4PT4S0000C 00016	HGM50L 4PNT4S0000C 00016	
20 A	HGM50L 2PT4S0000C 00020	HGM50L 3PT4S0000C 00020	HGM50L 4PT4S0000C 00020	HGM50L 4PNT4S0000C 00020	
25 A	HGM50L 2PT4S0000C 00025	HGM50L 3PT4S0000C 00025	HGM50L 4PT4S0000C 00025	HGM50L 4PNT4S0000C 00025	
32 A	HGM50L 2PT4S0000C 00032	HGM50L 3PT4S0000C 00032	HGM50L 4PT4S0000C 00032	HGM50L 4PNT4S0000C 00032	
40 A	HGM50L 2PT4S0000C 00040	HGM50L 3PT4S0000C 00040	HGM50L 4PT4S0000C 00040	HGM50L 4PNT4S0000C 00040	
50 A	HGM50L 2PT4S0000C 00050	HGM50L 3PT4S0000C 00050	HGM50L 4PT4S0000C 00050	HGM50L 4PNT4S0000C 00050	

Ordering Codes

HGM Type Molded Case Circuit Breakers (MCCB)

- Normal type/Front connection
- Except for accessory, Based on ambient temperature 40 °C and frequency 50/60 Hz

Fixing (Thermal Fixing / Instantaneous Fixing)

63 AF	In	2 Pole	3 Pole	4 Pole (RSTN)	4 Pole (NRST)
	HGM60E...16 kA / 460 V				
	16 A	HGM60E 2PT4S0000C 00016	HGM60E 3PT4S0000C 00016	HGM60E 4PT4S0000C 00016	HGM60E 4PNT4S0000C 00016
	20 A	HGM60E 2PT4S0000C 00020	HGM60E 3PT4S0000C 00020	HGM60E 4PT4S0000C 00020	HGM60E 4PNT4S0000C 00020
	25 A	HGM60E 2PT4S0000C 00025	HGM60E 3PT4S0000C 00025	HGM60E 4PT4S0000C 00025	HGM60E 4PNT4S0000C 00025
	32 A	HGM60E 2PT4S0000C 00032	HGM60E 3PT4S0000C 00032	HGM60E 4PT4S0000C 00032	HGM60E 4PNT4S0000C 00032
	40 A	HGM60E 2PT4S0000C 00040	HGM60E 3PT4S0000C 00040	HGM60E 4PT4S0000C 00040	HGM60E 4PNT4S0000C 00040
	50 A	HGM60E 2PT4S0000C 00050	HGM60E 3PT4S0000C 00050	HGM60E 4PT4S0000C 00050	HGM60E 4PNT4S0000C 00050
	63 A	HGM60E 2PT4S0000C 00063	HGM60E 3PT4S0000C 00063	HGM60E 4PT4S0000C 00063	HGM60E 4PNT4S0000C 00063
	HGM60S...20 kA / 460 V				
	16 A	HGM60S 2PT4S0000C 00016	HGM60S 3PT4S0000C 00016	HGM60S 4PT4S0000C 00016	HGM60S 4PNT4S0000C 00016
	20 A	HGM60S 2PT4S0000C 00020	HGM60S 3PT4S0000C 00020	HGM60S 4PT4S0000C 00020	HGM60S 4PNT4S0000C 00020
	25 A	HGM60S 2PT4S0000C 00025	HGM60S 3PT4S0000C 00025	HGM60S 4PT4S0000C 00025	HGM60S 4PNT4S0000C 00025
	32 A	HGM60S 2PT4S0000C 00032	HGM60S 3PT4S0000C 00032	HGM60S 4PT4S0000C 00032	HGM60S 4PNT4S0000C 00032
40 A	HGM60S 2PT4S0000C 00040	HGM60S 3PT4S0000C 00040	HGM60S 4PT4S0000C 00040	HGM60S 4PNT4S0000C 00040	
50 A	HGM60S 2PT4S0000C 00050	HGM60S 3PT4S0000C 00050	HGM60S 4PT4S0000C 00050	HGM60S 4PNT4S0000C 00050	
63 A	HGM60S 2PT4S0000C 00063	HGM60S 3PT4S0000C 00063	HGM60S 4PT4S0000C 00063	HGM60S 4PNT4S0000C 00063	
HGM60H...26 kA / 460 V					
16 A	HGM60H 2PT4S0000C 00016	HGM60H 3PT4S0000C 00016	HGM60H 4PT4S0000C 00016	HGM60H 4PNT4S0000C 00016	
20 A	HGM60H 2PT4S0000C 00020	HGM60H 3PT4S0000C 00020	HGM60H 4PT4S0000C 00020	HGM60H 4PNT4S0000C 00020	
25 A	HGM60H 2PT4S0000C 00025	HGM60H 3PT4S0000C 00025	HGM60H 4PT4S0000C 00025	HGM60H 4PNT4S0000C 00025	
32 A	HGM60H 2PT4S0000C 00032	HGM60H 3PT4S0000C 00032	HGM60H 4PT4S0000C 00032	HGM60H 4PNT4S0000C 00032	
40 A	HGM60H 2PT4S0000C 00040	HGM60H 3PT4S0000C 00040	HGM60H 4PT4S0000C 00040	HGM60H 4PNT4S0000C 00040	
50 A	HGM60H 2PT4S0000C 00050	HGM60H 3PT4S0000C 00050	HGM60H 4PT4S0000C 00050	HGM60H 4PNT4S0000C 00050	
63 A	HGM60H 2PT4S0000C 00063	HGM60H 3PT4S0000C 00063	HGM60H 4PT4S0000C 00063	HGM60H 4PNT4S0000C 00063	
HGM60L...30 kA / 460 V					
16 A	HGM60L 2PT4S0000C 00016	HGM60L 3PT4S0000C 00016	HGM60L 4PT4S0000C 00016	HGM60L 4PNT4S0000C 00016	
20 A	HGM60L 2PT4S0000C 00020	HGM60L 3PT4S0000C 00020	HGM60L 4PT4S0000C 00020	HGM60L 4PNT4S0000C 00020	
25 A	HGM60L 2PT4S0000C 00025	HGM60L 3PT4S0000C 00025	HGM60L 4PT4S0000C 00025	HGM60L 4PNT4S0000C 00025	
32 A	HGM60L 2PT4S0000C 00032	HGM60L 3PT4S0000C 00032	HGM60L 4PT4S0000C 00032	HGM60L 4PNT4S0000C 00032	
40 A	HGM60L 2PT4S0000C 00040	HGM60L 3PT4S0000C 00040	HGM60L 4PT4S0000C 00040	HGM60L 4PNT4S0000C 00040	
50 A	HGM60L 2PT4S0000C 00050	HGM60L 3PT4S0000C 00050	HGM60L 4PT4S0000C 00050	HGM60L 4PNT4S0000C 00050	
63 A	HGM60L 2PT4S0000C 00063	HGM60L 3PT4S0000C 00063	HGM60L 4PT4S0000C 00063	HGM60L 4PNT4S0000C 00063	

100 AF	In	2 Pole	3 Pole	4 Pole (RSTN)	4 Pole (NRST)
	HGM100E...16 kA / 460 V				
	16 A	HGM100E 2PT4S0000C 00016	HGM100E 3PT4S0000C 00016	HGM100E 4PT4S0000C 00016	HGM100E 4PNT4S0000C 00016
	20 A	HGM100E 2PT4S0000C 00020	HGM100E 3PT4S0000C 00020	HGM100E 4PT4S0000C 00020	HGM100E 4PNT4S0000C 00020
	25 A	HGM100E 2PT4S0000C 00025	HGM100E 3PT4S0000C 00025	HGM100E 4PT4S0000C 00025	HGM100E 4PNT4S0000C 00025
	32 A	HGM100E 2PT4S0000C 00032	HGM100E 3PT4S0000C 00032	HGM100E 4PT4S0000C 00032	HGM100E 4PNT4S0000C 00032
	40 A	HGM100E 2PT4S0000C 00040	HGM100E 3PT4S0000C 00040	HGM100E 4PT4S0000C 00040	HGM100E 4PNT4S0000C 00040
	50 A	HGM100E 2PT4S0000C 00050	HGM100E 3PT4S0000C 00050	HGM100E 4PT4S0000C 00050	HGM100E 4PNT4S0000C 00050
	63 A	HGM100E 2PT4S0000C 00063	HGM100E 3PT4S0000C 00063	HGM100E 4PT4S0000C 00063	HGM100E 4PNT4S0000C 00063
	75 A	HGM100E 2PT4S0000C 00075	HGM100E 3PT4S0000C 00075	HGM100E 4PT4S0000C 00075	HGM100E 4PNT4S0000C 00075
	80 A	HGM100E 2PT4S0000C 00080	HGM100E 3PT4S0000C 00080	HGM100E 4PT4S0000C 00080	HGM100E 4PNT4S0000C 00080
	100 A	HGM100E 2PT4S0000C 00100	HGM100E 3PT4S0000C 00100	HGM100E 4PT4S0000C 00100	HGM100E 4PNT4S0000C 00100

Ordering Codes

HGM Type Molded Case Circuit Breakers (MCCB)

- Normal type/Front connection
- Except for accessory, Based on ambient temperature 40 °C and frequency 50/60 Hz

Fixing (Thermal Fixing / Instantaneous Fixing)

125 AF	In	2 Pole	3 Pole	4 Pole (RSTN)	4 Pole (NRST)
	HGM125S...26 kA / 460 V				
	16 A	HGM125S 2PT4S0000C 00016	HGM125S 3PT4S0000C 00016	HGM125S 4PT4S0000C 00016	HGM125S 4PNT4S0000C 00016
	20 A	HGM125S 2PT4S0000C 00020	HGM125S 3PT4S0000C 00020	HGM125S 4PT4S0000C 00020	HGM125S 4PNT4S0000C 00020
	25 A	HGM125S 2PT4S0000C 00025	HGM125S 3PT4S0000C 00025	HGM125S 4PT4S0000C 00025	HGM125S 4PNT4S0000C 00025
	32 A	HGM125S 2PT4S0000C 00032	HGM125S 3PT4S0000C 00032	HGM125S 4PT4S0000C 00032	HGM125S 4PNT4S0000C 00032
	40 A	HGM125S 2PT4S0000C 00040	HGM125S 3PT4S0000C 00040	HGM125S 4PT4S0000C 00040	HGM125S 4PNT4S0000C 00040
	50 A	HGM125S 2PT4S0000C 00050	HGM125S 3PT4S0000C 00050	HGM125S 4PT4S0000C 00050	HGM125S 4PNT4S0000C 00050
	63 A	HGM125S 2PT4S0000C 00063	HGM125S 3PT4S0000C 00063	HGM125S 4PT4S0000C 00063	HGM125S 4PNT4S0000C 00063
	75 A	HGM125S 2PT4S0000C 00075	HGM125S 3PT4S0000C 00075	HGM125S 4PT4S0000C 00075	HGM125S 4PNT4S0000C 00075
	80 A	HGM125S 2PT4S0000C 00080	HGM125S 3PT4S0000C 00080	HGM125S 4PT4S0000C 00080	HGM125S 4PNT4S0000C 00080
	100 A	HGM125S 2PT4S0000C 00100	HGM125S 3PT4S0000C 00100	HGM125S 4PT4S0000C 00100	HGM125S 4PNT4S0000C 00100
	125 A	HGM125S 2PT4S0000C 00125	HGM125S 3PT4S0000C 00125	HGM125S 4PT4S0000C 00125	HGM125S 4PNT4S0000C 00125
	HGM125H...38 kA / 460 V				
	16 A	HGM125H 2PT4S0000C 00016	HGM125H 3PT4S0000C 00016	HGM125H 4PT4S0000C 00016	HGM125H 4PNT4S0000C 00016
	20 A	HGM125H 2PT4S0000C 00020	HGM125H 3PT4S0000C 00020	HGM125H 4PT4S0000C 00020	HGM125H 4PNT4S0000C 00020
25 A	HGM125H 2PT4S0000C 00025	HGM125H 3PT4S0000C 00025	HGM125H 4PT4S0000C 00025	HGM125H 4PNT4S0000C 00025	
32 A	HGM125H 2PT4S0000C 00032	HGM125H 3PT4S0000C 00032	HGM125H 4PT4S0000C 00032	HGM125H 4PNT4S0000C 00032	
40 A	HGM125H 2PT4S0000C 00040	HGM125H 3PT4S0000C 00040	HGM125H 4PT4S0000C 00040	HGM125H 4PNT4S0000C 00040	
50 A	HGM125H 2PT4S0000C 00050	HGM125H 3PT4S0000C 00050	HGM125H 4PT4S0000C 00050	HGM125H 4PNT4S0000C 00050	
63 A	HGM125H 2PT4S0000C 00063	HGM125H 3PT4S0000C 00063	HGM125H 4PT4S0000C 00063	HGM125H 4PNT4S0000C 00063	
75 A	HGM125H 2PT4S0000C 00075	HGM125H 3PT4S0000C 00075	HGM125H 4PT4S0000C 00075	HGM125H 4PNT4S0000C 00075	
80 A	HGM125H 2PT4S0000C 00080	HGM125H 3PT4S0000C 00080	HGM125H 4PT4S0000C 00080	HGM125H 4PNT4S0000C 00080	
100 A	HGM125H 2PT4S0000C 00100	HGM125H 3PT4S0000C 00100	HGM125H 4PT4S0000C 00100	HGM125H 4PNT4S0000C 00100	
125 A	HGM125H 2PT4S0000C 00125	HGM125H 3PT4S0000C 00125	HGM125H 4PT4S0000C 00125	HGM125H 4PNT4S0000C 00125	
HGM125L...55 kA / 460 V					
16 A	HGM125L 2PT4S0000C 00016	HGM125L 3PT4S0000C 00016	HGM125L 4PT4S0000C 00016	HGM125L 4PNT4S0000C 00016	
20 A	HGM125L 2PT4S0000C 00020	HGM125L 3PT4S0000C 00020	HGM125L 4PT4S0000C 00020	HGM125L 4PNT4S0000C 00020	
25 A	HGM125L 2PT4S0000C 00025	HGM125L 3PT4S0000C 00025	HGM125L 4PT4S0000C 00025	HGM125L 4PNT4S0000C 00025	
32 A	HGM125L 2PT4S0000C 00032	HGM125L 3PT4S0000C 00032	HGM125L 4PT4S0000C 00032	HGM125L 4PNT4S0000C 00032	
40 A	HGM125L 2PT4S0000C 00040	HGM125L 3PT4S0000C 00040	HGM125L 4PT4S0000C 00040	HGM125L 4PNT4S0000C 00040	
50 A	HGM125L 2PT4S0000C 00050	HGM125L 3PT4S0000C 00050	HGM125L 4PT4S0000C 00050	HGM125L 4PNT4S0000C 00050	
63 A	HGM125L 2PT4S0000C 00063	HGM125L 3PT4S0000C 00063	HGM125L 4PT4S0000C 00063	HGM125L 4PNT4S0000C 00063	
75 A	HGM125L 2PT4S0000C 00075	HGM125L 3PT4S0000C 00075	HGM125L 4PT4S0000C 00075	HGM125L 4PNT4S0000C 00075	
80 A	HGM125L 2PT4S0000C 00080	HGM125L 3PT4S0000C 00080	HGM125L 4PT4S0000C 00080	HGM125L 4PNT4S0000C 00080	
100 A	HGM125L 2PT4S0000C 00100	HGM125L 3PT4S0000C 00100	HGM125L 4PT4S0000C 00100	HGM125L 4PNT4S0000C 00100	
125 A	HGM125L 2PT4S0000C 00125	HGM125L 3PT4S0000C 00125	HGM125L 4PT4S0000C 00125	HGM125L 4PNT4S0000C 00125	

160 AF	In	2 Pole	3 Pole	4 Pole (RSTN)	4 Pole (NRST)
	HGM160E...20 kA / 460 V				
	100 A	HGM160E 2PT4S0000C 00100	HGM160E 3PT4S0000C 00100	HGM160E 4PT4S0000C 00100	HGM160E 4PNT4S0000C 00100
	125 A	HGM160E 2PT4S0000C 00125	HGM160E 3PT4S0000C 00125	HGM160E 4PT4S0000C 00125	HGM160E 4PNT4S0000C 00125
	150 A	HGM160E 2PT4S0000C 00150	HGM160E 3PT4S0000C 00150	HGM160E 4PT4S0000C 00150	HGM160E 4PNT4S0000C 00150
	160 A	HGM160E 2PT4S0000C 00160	HGM160E 3PT4S0000C 00160	HGM160E 4PT4S0000C 00160	HGM160E 4PNT4S0000C 00160
HGM160S...26 kA / 460 V					
100 A	HGM160S 2PT4S0000C 00100	HGM160S 3PT4S0000C 00100	HGM160S 4PT4S0000C 00100	HGM160S 4PNT4S0000C 00100	
125 A	HGM160S 2PT4S0000C 00125	HGM160S 3PT4S0000C 00125	HGM160S 4PT4S0000C 00125	HGM160S 4PNT4S0000C 00125	
150 A	HGM160S 2PT4S0000C 00150	HGM160S 3PT4S0000C 00150	HGM160S 4PT4S0000C 00150	HGM160S 4PNT4S0000C 00150	
160 A	HGM160S 2PT4S0000C 00160	HGM160S 3PT4S0000C 00160	HGM160S 4PT4S0000C 00160	HGM160S 4PNT4S0000C 00160	

Ordering Codes

HGM Type Molded Case Circuit Breakers (MCCB)

- Normal type/Front connection
- Except for accessory, Based on ambient temperature 40 °C and frequency 50/60 Hz

Fixing (Thermal Fixing / Instantaneous Fixing)

400 AF	In	2 Pole	3 Pole	4 Pole (RSTN)	4 Pole (NRST)
	HGM400E...38 kA / 460 V				
	250 A	HGM400E 2PT4S0000C 00250	HGM400E 3PT4S0000C 00250	HGM400E 4PT4S0000C 00250	HGM400E 4PNT4S0000C 00250
	300 A	HGM400E 2PT4S0000C 00300	HGM400E 3PT4S0000C 00300	HGM400E 4PT4S0000C 00300	HGM400E 4PNT4S0000C 00300
	350 A	HGM400E 2PT4S0000C 00350	HGM400E 3PT4S0000C 00350	HGM400E 4PT4S0000C 00350	HGM400E 4PNT4S0000C 00350
	400 A	HGM400E 2PT4S0000C 00400	HGM400E 3PT4S0000C 00400	HGM400E 4PT4S0000C 00400	HGM400E 4PNT4S0000C 00400
	HGM400S...50 kA / 460 V				
	250 A	HGM400S 2PT4S0000C 00250	HGM400S 3PT4S0000C 00250	HGM400S 4PT4S0000C 00250	HGM400S 4PNT4S0000C 00250
	300 A	HGM400S 2PT4S0000C 00300	HGM400S 3PT4S0000C 00300	HGM400S 4PT4S0000C 00300	HGM400S 4PNT4S0000C 00300
	350 A	HGM400S 2PT4S0000C 00350	HGM400S 3PT4S0000C 00350	HGM400S 4PT4S0000C 00350	HGM400S 4PNT4S0000C 00350
	400 A	HGM400S 2PT4S0000C 00400	HGM400S 3PT4S0000C 00400	HGM400S 4PT4S0000C 00400	HGM400S 4PNT4S0000C 00400
	HGM400H...70 kA / 460 V				
	250 A	HGM400H 2PT4S0000C 00250	HGM400H 3PT4S0000C 00250	HGM400H 4PT4S0000C 00250	HGM400H 4PNT4S0000C 00250
	300 A	HGM400H 2PT4S0000C 00300	HGM400H 3PT4S0000C 00300	HGM400H 4PT4S0000C 00300	HGM400H 4PNT4S0000C 00300
	350 A	HGM400H 2PT4S0000C 00350	HGM400H 3PT4S0000C 00350	HGM400H 4PT4S0000C 00350	HGM400H 4PNT4S0000C 00350
	400 A	HGM400H 2PT4S0000C 00400	HGM400H 3PT4S0000C 00400	HGM400H 4PT4S0000C 00400	HGM400H 4PNT4S0000C 00400
	HGM400L...85 kA / 460 V				
250 A	HGM400L 2PT4S0000C 00250	HGM400L 3PT4S0000C 00250	HGM400L 4PT4S0000C 00250	HGM400L 4PNT4S0000C 00250	
300 A	HGM400L 2PT4S0000C 00300	HGM400L 3PT4S0000C 00300	HGM400L 4PT4S0000C 00300	HGM400L 4PNT4S0000C 00300	
350 A	HGM400L 2PT4S0000C 00350	HGM400L 3PT4S0000C 00350	HGM400L 4PT4S0000C 00350	HGM400L 4PNT4S0000C 00350	
400 A	HGM400L 2PT4S0000C 00400	HGM400L 3PT4S0000C 00400	HGM400L 4PT4S0000C 00400	HGM400L 4PNT4S0000C 00400	

630 AF	In	2 Pole	3 Pole	4 Pole (RSTN)	4 Pole (NRST)
	HGM630E...38 kA / 460 V				
	500 A	HGM630E 2PT4S0000C 00500	HGM630E 3PT4S0000C 00500	HGM630E 4PT4S0000C 00500	HGM630E 4PNT4S0000C 00500
	630 A	HGM630E 2PT4S0000C 00630	HGM630E 3PT4S0000C 00630	HGM630E 4PT4S0000C 00630	HGM630E 4PNT4S0000C 00630
	HGM630S...50 kA / 460 V				
	500 A	HGM630S 2PT4S0000C 00500	HGM630S 3PT4S0000C 00500	HGM630S 4PT4S0000C 00500	HGM630S 4PNT4S0000C 00500
	630 A	HGM630S 2PT4S0000C 00630	HGM630S 3PT4S0000C 00630	HGM630S 4PT4S0000C 00630	HGM630S 4PNT4S0000C 00630
	HGM630H...70 kA / 460 V				
	500 A	HGM630H 2PT4S0000C 00500	HGM630H 3PT4S0000C 00500	HGM630H 4PT4S0000C 00500	HGM630H 4PNT4S0000C 00500
	630 A	HGM630H 2PT4S0000C 00630	HGM630H 3PT4S0000C 00630	HGM630H 4PT4S0000C 00630	HGM630H 4PNT4S0000C 00630
	HGM630L...85 kA / 460 V				
	500 A	HGM630L 2PT4S0000C 00500	HGM630L 3PT4S0000C 00500	HGM630L 4PT4S0000C 00500	HGM630L 4PNT4S0000C 00500
	630 A	HGM630L 2PT4S0000C 00630	HGM630L 3PT4S0000C 00630	HGM630L 4PT4S0000C 00630	HGM630L 4PNT4S0000C 00630

800 AF	In	2 Pole	3 Pole	4 Pole (RSTN)	4 Pole (NRST)
	HGM800S...50 kA / 460 V				
	700 A	HGM800S 2PT4S0000C 00700	HGM800S 3PT4S0000C 00700	HGM800S 4PT4S0000C 00700	HGM800S 4PNT4S0000C 00700
	800 A	HGM800S 2PT4S0000C 00800	HGM800S 3PT4S0000C 00800	HGM800S 4PT4S0000C 00800	HGM800S 4PNT4S0000C 00800
	HGM800H...70 kA / 460 V				
	700 A	HGM800H 2PT4S0000C 00700	HGM800H 3PT4S0000C 00700	HGM800H 4PT4S0000C 00700	HGM800H 4PNT4S0000C 00700
	800 A	HGM800H 2PT4S0000C 00800	HGM800H 3PT4S0000C 00800	HGM800H 4PT4S0000C 00800	HGM800H 4PNT4S0000C 00800
	HGM800L...85 kA / 460 V				
	700 A	HGM800L 2PT4S0000C 00700	HGM800L 3PT4S0000C 00700	HGM800L 4PT4S0000C 00700	HGM800L 4PNT4S0000C 00700
	800 A	HGM800L 2PT4S0000C 00800	HGM800L 3PT4S0000C 00800	HGM800L 4PT4S0000C 00800	HGM800L 4PNT4S0000C 00800

HGM Type ZCT Molded Case Circuit Breakers (ZCT MCCB)

- Normal type/Front connection
- Except for accessory, Based on ambient temperature 40 °C and frequency 50/60 Hz

32 AF	In	2 Pole	3 Pole	4 Pole (RSTN)	4 Pole (NRST)
	HGM30E...16 kA / 460 V				
	16 A	HGM30E 2ZT4S0000C 00016	HGM30E 3ZT4S0000C 00016	HGM30E 4ZT4S0000C 00016	-
	20 A	HGM30E 2ZT4S0000C 00020	HGM30E 3ZT4S0000C 00020	HGM30E 4ZT4S0000C 00020	-
	25 A	HGM30E 2ZT4S0000C 00025	HGM30E 3ZT4S0000C 00025	HGM30E 4ZT4S0000C 00025	-
	32 A	HGM30E 2ZT4S0000C 00032	HGM30E 3ZT4S0000C 00032	HGM30E 4ZT4S0000C 00032	-
	HGM30S...20 kA / 460 V				
	16 A	HGM30S 2ZT4S0000C 00016	HGM30S 3ZT4S0000C 00016	HGM30S 4ZT4S0000C 00016	-
	20 A	HGM30S 2ZT4S0000C 00020	HGM30S 3ZT4S0000C 00020	HGM30S 4ZT4S0000C 00020	-
	25 A	HGM30S 2ZT4S0000C 00025	HGM30S 3ZT4S0000C 00025	HGM30S 4ZT4S0000C 00025	-
	32 A	HGM30S 2ZT4S0000C 00032	HGM30S 3ZT4S0000C 00032	HGM30S 4ZT4S0000C 00032	-

50 AF	In	2 Pole	3 Pole	4 Pole (RSTN)	4 Pole (NRST)
	HGM50E...16 kA / 460 V				
	16 A	HGM50E 2ZT4S0000C 00016	HGM50E 3ZT4S0000C 00016	HGM50E 4ZT4S0000C 00016	-
	20 A	HGM50E 2ZT4S0000C 00020	HGM50E 3ZT4S0000C 00020	HGM50E 4ZT4S0000C 00020	-
	25 A	HGM50E 2ZT4S0000C 00025	HGM50E 3ZT4S0000C 00025	HGM50E 4ZT4S0000C 00025	-
	32 A	HGM50E 2ZT4S0000C 00032	HGM50E 3ZT4S0000C 00032	HGM50E 4ZT4S0000C 00032	-
	40 A	HGM50E 2ZT4S0000C 00040	HGM50E 3ZT4S0000C 00040	HGM50E 4ZT4S0000C 00040	-
	50 A	HGM50E 2ZT4S0000C 00050	HGM50E 3ZT4S0000C 00050	HGM50E 4ZT4S0000C 00050	-
	HGM50S...20 kA / 460 V				
	16 A	HGM50S 2ZT4S0000C 00016	HGM50S 3ZT4S0000C 00016	HGM50S 4ZT4S0000C 00016	-
	20 A	HGM50S 2ZT4S0000C 00020	HGM50S 3ZT4S0000C 00020	HGM50S 4ZT4S0000C 00020	-
	25 A	HGM50S 2ZT4S0000C 00025	HGM50S 3ZT4S0000C 00025	HGM50S 4ZT4S0000C 00025	-
	32 A	HGM50S 2ZT4S0000C 00032	HGM50S 3ZT4S0000C 00032	HGM50S 4ZT4S0000C 00032	-
	40 A	HGM50S 2ZT4S0000C 00040	HGM50S 3ZT4S0000C 00040	HGM50S 4ZT4S0000C 00040	-
	50 A	HGM50S 2ZT4S0000C 00050	HGM50S 3ZT4S0000C 00050	HGM50S 4ZT4S0000C 00050	-
	HGM50H...38 kA / 460 V				
	16 A	HGM50H 2ZT4S0000C 00016	HGM50H 3ZT4S0000C 00016	HGM50H 4ZT4S0000C 00016	-
	20 A	HGM50H 2ZT4S0000C 00020	HGM50H 3ZT4S0000C 00020	HGM50H 4ZT4S0000C 00020	-
	25 A	HGM50H 2ZT4S0000C 00025	HGM50H 3ZT4S0000C 00025	HGM50H 4ZT4S0000C 00025	-
	32 A	HGM50H 2ZT4S0000C 00032	HGM50H 3ZT4S0000C 00032	HGM50H 4ZT4S0000C 00032	-
	40 A	HGM50H 2ZT4S0000C 00040	HGM50H 3ZT4S0000C 00040	HGM50H 4ZT4S0000C 00040	-
	50 A	HGM50H 2ZT4S0000C 00050	HGM50H 3ZT4S0000C 00050	HGM50H 4ZT4S0000C 00050	-
	HGM50L...55 kA / 460 V				
	16 A	HGM50L 2ZT4S0000C 00016	HGM50L 3ZT4S0000C 00016	HGM50L 4ZT4S0000C 00016	-
	20 A	HGM50L 2ZT4S0000C 00020	HGM50L 3ZT4S0000C 00020	HGM50L 4ZT4S0000C 00020	-
25 A	HGM50L 2ZT4S0000C 00025	HGM50L 3ZT4S0000C 00025	HGM50L 4ZT4S0000C 00025	-	
32 A	HGM50L 2ZT4S0000C 00032	HGM50L 3ZT4S0000C 00032	HGM50L 4ZT4S0000C 00032	-	
40 A	HGM50L 2ZT4S0000C 00040	HGM50L 3ZT4S0000C 00040	HGM50L 4ZT4S0000C 00040	-	
50 A	HGM50L 2ZT4S0000C 00050	HGM50L 3ZT4S0000C 00050	HGM50L 4ZT4S0000C 00050	-	

Ordering Codes

HGM Type ZCT Molded Case Circuit Breakers (ZCT MCCB)

- Normal type/Front connection
- Except for accessory, Based on ambient temperature 40 °C and frequency 50/60 Hz

63 AF	In	2 Pole	3 Pole	4 Pole (RSTN)	4 Pole (NRST)
	HGM60E...16 kA / 460 V				
	16 A	HGM60E 2ZT4S0000C 00016	HGM60E 3ZT4S0000C 00016	HGM60E 4ZT4S0000C 00016	-
	20 A	HGM60E 2ZT4S0000C 00020	HGM60E 3ZT4S0000C 00020	HGM60E 4ZT4S0000C 00020	-
	25 A	HGM60E 2ZT4S0000C 00025	HGM60E 3ZT4S0000C 00025	HGM60E 4ZT4S0000C 00025	-
	32 A	HGM60E 2ZT4S0000C 00032	HGM60E 3ZT4S0000C 00032	HGM60E 4ZT4S0000C 00032	-
	40 A	HGM60E 2ZT4S0000C 00040	HGM60E 3ZT4S0000C 00040	HGM60E 4ZT4S0000C 00040	-
	50 A	HGM60E 2ZT4S0000C 00050	HGM60E 3ZT4S0000C 00050	HGM60E 4ZT4S0000C 00050	-
	63 A	HGM60E 2ZT4S0000C 00063	HGM60E 3ZT4S0000C 00063	HGM60E 4ZT4S0000C 00063	-
	HGM60S...20 kA / 460 V				
	16A	HGM60S 2ZT4S0000C 00016	HGM60S 3ZT4S0000C 00016	HGM60S 4ZT4S0000C 00016	-
	20A	HGM60S 2ZT4S0000C 00020	HGM60S 3ZT4S0000C 00020	HGM60S 4ZT4S0000C 00020	-
	25A	HGM60S 2ZT4S0000C 00025	HGM60S 3ZT4S0000C 00025	HGM60S 4ZT4S0000C 00025	-
	32A	HGM60S 2ZT4S0000C 00032	HGM60S 3ZT4S0000C 00032	HGM60S 4ZT4S0000C 00032	-
	40A	HGM60S 2ZT4S0000C 00040	HGM60S 3ZT4S0000C 00040	HGM60S 4ZT4S0000C 00040	-
50A	HGM60S 2ZT4S0000C 00050	HGM60S 3ZT4S0000C 00050	HGM60S 4ZT4S0000C 00050	-	
63A	HGM60S 2ZT4S0000C 00063	HGM60S 3ZT4S0000C 00063	HGM60S 4ZT4S0000C 00063	-	
HGM60H...26 kA / 460 V					
16 A	HGM60H 2ZT4S0000C 00016	HGM60H 3ZT4S0000C 00016	HGM60H 4ZT4S0000C 00016	-	
20 A	HGM60H 2ZT4S0000C 00020	HGM60H 3ZT4S0000C 00020	HGM60H 4ZT4S0000C 00020	-	
25 A	HGM60H 2ZT4S0000C 00025	HGM60H 3ZT4S0000C 00025	HGM60H 4ZT4S0000C 00025	-	
32 A	HGM60H 2ZT4S0000C 00032	HGM60H 3ZT4S0000C 00032	HGM60H 4ZT4S0000C 00032	-	
40 A	HGM60H 2ZT4S0000C 00040	HGM60H 3ZT4S0000C 00040	HGM60H 4ZT4S0000C 00040	-	
50 A	HGM60H 2ZT4S0000C 00050	HGM60H 3ZT4S0000C 00050	HGM60H 4ZT4S0000C 00050	-	
63 A	HGM60H 2ZT4S0000C 00063	HGM60H 3ZT4S0000C 00063	HGM60H 4ZT4S0000C 00063	-	
HGM60L...30 kA / 460 V					
16 A	HGM60L 2ZT4S0000C 00016	HGM60L 3ZT4S0000C 00016	HGM60L 4ZT4S0000C 00016	-	
20 A	HGM60L 2ZT4S0000C 00020	HGM60L 3ZT4S0000C 00020	HGM60L 4ZT4S0000C 00020	-	
25 A	HGM60L 2ZT4S0000C 00025	HGM60L 3ZT4S0000C 00025	HGM60L 4ZT4S0000C 00025	-	
32 A	HGM60L 2ZT4S0000C 00032	HGM60L 3ZT4S0000C 00032	HGM60L 4ZT4S0000C 00032	-	
40 A	HGM60L 2ZT4S0000C 00040	HGM60L 3ZT4S0000C 00040	HGM60L 4ZT4S0000C 00040	-	
50 A	HGM60L 2ZT4S0000C 00050	HGM60L 3ZT4S0000C 00050	HGM60L 4ZT4S0000C 00050	-	
63 A	HGM60L 2ZT4S0000C 00063	HGM60L 3ZT4S0000C 00063	HGM60L 4ZT4S0000C 00063	-	

100 AF	In	2 Pole	3 Pole	4 Pole (RSTN)	4 Pole (NRST)
	HGM100E...16 kA / 460 V				
	16 A	HGM100E 2ZT4S0000C 00016	HGM100E 3ZT4S0000C 00016	HGM100E 4ZT4S0000C 00016	-
	20 A	HGM100E 2ZT4S0000C 00020	HGM100E 3ZT4S0000C 00020	HGM100E 4ZT4S0000C 00020	-
	25 A	HGM100E 2ZT4S0000C 00025	HGM100E 3ZT4S0000C 00025	HGM100E 4ZT4S0000C 00025	-
	32 A	HGM100E 2ZT4S0000C 00032	HGM100E 3ZT4S0000C 00032	HGM100E 4ZT4S0000C 00032	-
	40 A	HGM100E 2ZT4S0000C 00040	HGM100E 3ZT4S0000C 00040	HGM100E 4ZT4S0000C 00040	-
	50 A	HGM100E 2ZT4S0000C 00050	HGM100E 3ZT4S0000C 00050	HGM100E 4ZT4S0000C 00050	-
	63 A	HGM100E 2ZT4S0000C 00063	HGM100E 3ZT4S0000C 00063	HGM100E 4ZT4S0000C 00063	-
	75 A	HGM100E 2ZT4S0000C 00075	HGM100E 3ZT4S0000C 00075	HGM100E 4ZT4S0000C 00075	-
	80 A	HGM100E 2ZT4S0000C 00080	HGM100E 3ZT4S0000C 00080	HGM100E 4ZT4S0000C 00080	-
	100 A	HGM100E 2ZT4S0000C 00100	HGM100E 3ZT4S0000C 00100	HGM100E 4ZT4S0000C 00100	-

100 AF	In	2 Pole	3 Pole	4 Pole (RSTN)	4 Pole (NRST)
	HGM100S...20 kA / 460 V				
	16 A	HGM100S 2ZT4S0000C 00016	HGM100S 3ZT4S0000C 00016	HGM100S 4ZT4S0000C 00016	-
	20 A	HGM100S 2ZT4S0000C 00020	HGM100S 3ZT4S0000C 00020	HGM100S 4ZT4S0000C 00020	-
	25 A	HGM100S 2ZT4S0000C 00025	HGM100S 3ZT4S0000C 00025	HGM100S 4ZT4S0000C 00025	-
	32 A	HGM100S 2ZT4S0000C 00032	HGM100S 3ZT4S0000C 00032	HGM100S 4ZT4S0000C 00032	-
	40 A	HGM100S 2ZT4S0000C 00040	HGM100S 3ZT4S0000C 00040	HGM100S 4ZT4S0000C 00040	-
	50 A	HGM100S 2ZT4S0000C 00050	HGM100S 3ZT4S0000C 00050	HGM100S 4ZT4S0000C 00050	-
	63 A	HGM100S 2ZT4S0000C 00063	HGM100S 3ZT4S0000C 00063	HGM100S 4ZT4S0000C 00063	-
	75 A	HGM100S 2ZT4S0000C 00075	HGM100S 3ZT4S0000C 00075	HGM100S 4ZT4S0000C 00075	-
	80 A	HGM100S 2ZT4S0000C 00080	HGM100S 3ZT4S0000C 00080	HGM100S 4ZT4S0000C 00080	-
	100 A	HGM100S 2ZT4S0000C 00100	HGM100S 3ZT4S0000C 00100	HGM100S 4ZT4S0000C 00100	-
	HGM100H...38 kA / 460 V				
	16 A	HGM100H 2ZT4S0000C 00016	HGM100H 3ZT4S0000C 00016	HGM100H 4ZT4S0000C 00016	-
	20 A	HGM100H 2ZT4S0000C 00020	HGM100H 3ZT4S0000C 00020	HGM100H 4ZT4S0000C 00020	-
25 A	HGM100H 2ZT4S0000C 00025	HGM100H 3ZT4S0000C 00025	HGM100H 4ZT4S0000C 00025	-	
32 A	HGM100H 2ZT4S0000C 00032	HGM100H 3ZT4S0000C 00032	HGM100H 4ZT4S0000C 00032	-	
40 A	HGM100H 2ZT4S0000C 00040	HGM100H 3ZT4S0000C 00040	HGM100H 4ZT4S0000C 00040	-	
50 A	HGM100H 2ZT4S0000C 00050	HGM100H 3ZT4S0000C 00050	HGM100H 4ZT4S0000C 00050	-	
63 A	HGM100H 2ZT4S0000C 00063	HGM100H 3ZT4S0000C 00063	HGM100H 4ZT4S0000C 00063	-	
75 A	HGM100H 2ZT4S0000C 00075	HGM100H 3ZT4S0000C 00075	HGM100H 4ZT4S0000C 00075	-	
80 A	HGM100H 2ZT4S0000C 00080	HGM100H 3ZT4S0000C 00080	HGM100H 4ZT4S0000C 00080	-	
100 A	HGM100H 2ZT4S0000C 00100	HGM100H 3ZT4S0000C 00100	HGM100H 4ZT4S0000C 00100	-	
HGM100L...30 kA / 460 V					
16 A	HGM100L 2ZT4S0000C 00016	HGM100L 3ZT4S0000C 00016	HGM100L 4ZT4S0000C 00016	-	
20 A	HGM100L 2ZT4S0000C 00020	HGM100L 3ZT4S0000C 00020	HGM100L 4ZT4S0000C 00020	-	
25 A	HGM100L 2ZT4S0000C 00025	HGM100L 3ZT4S0000C 00025	HGM100L 4ZT4S0000C 00025	-	
32 A	HGM100L 2ZT4S0000C 00032	HGM100L 3ZT4S0000C 00032	HGM100L 4ZT4S0000C 00032	-	
40 A	HGM100L 2ZT4S0000C 00040	HGM100L 3ZT4S0000C 00040	HGM100L 4ZT4S0000C 00040	-	
50 A	HGM100L 2ZT4S0000C 00050	HGM100L 3ZT4S0000C 00050	HGM100L 4ZT4S0000C 00050	-	
63 A	HGM100L 2ZT4S0000C 00063	HGM100L 3ZT4S0000C 00063	HGM100L 4ZT4S0000C 00063	-	
75 A	HGM100L 2ZT4S0000C 00075	HGM100L 3ZT4S0000C 00075	HGM100L 4ZT4S0000C 00075	-	
80 A	HGM100L 2ZT4S0000C 00080	HGM100L 3ZT4S0000C 00080	HGM100L 4ZT4S0000C 00080	-	
100 A	HGM100L 2ZT4S0000C 00100	HGM100L 3ZT4S0000C 00100	HGM100L 4ZT4S0000C 00100	-	

125 AF	In	2 Pole	3 Pole	4 Pole (RSTN)	4 Pole (NRST)
	HGM125E...20 kA / 460 V				
	16 A	HGM125E 2ZT4S0000C 00016	HGM125E 3ZT4S0000C 00016	HGM125E 4ZT4S0000C 00016	-
	20 A	HGM125E 2ZT4S0000C 00020	HGM125E 3ZT4S0000C 00020	HGM125E 4ZT4S0000C 00020	-
	25 A	HGM125E 2ZT4S0000C 00025	HGM125E 3ZT4S0000C 00025	HGM125E 4ZT4S0000C 00025	-
	32 A	HGM125E 2ZT4S0000C 00032	HGM125E 3ZT4S0000C 00032	HGM125E 4ZT4S0000C 00032	-
	40 A	HGM125E 2ZT4S0000C 00040	HGM125E 3ZT4S0000C 00040	HGM125E 4ZT4S0000C 00040	-
	50 A	HGM125E 2ZT4S0000C 00050	HGM125E 3ZT4S0000C 00050	HGM125E 4ZT4S0000C 00050	-
	63 A	HGM125E 2ZT4S0000C 00063	HGM125E 3ZT4S0000C 00063	HGM125E 4ZT4S0000C 00063	-
	75 A	HGM125E 2ZT4S0000C 00075	HGM125E 3ZT4S0000C 00075	HGM125E 4ZT4S0000C 00075	-
	80 A	HGM125E 2ZT4S0000C 00080	HGM125E 3ZT4S0000C 00080	HGM125E 4ZT4S0000C 00080	-
	100 A	HGM125E 2ZT4S0000C 00100	HGM125E 3ZT4S0000C 00100	HGM125E 4ZT4S0000C 00100	-
	125 A	HGM125E 2ZT4S0000C 00125	HGM125E 3ZT4S0000C 00125	HGM125E 4ZT4S0000C 00125	-

Ordering Codes

HGM Type ZCT Molded Case Circuit Breakers (ZCT MCCB)

- Normal type/Front connection
- Except for accessory, Based on ambient temperature 40 °C and frequency 50/60 Hz

125 AF	In	2 Pole	3 Pole	4 Pole (RSTN)	4 Pole (NRST)
	HGM125S...26 kA / 460 V				
	16 A	HGM125S 2ZT4S0000C 00016	HGM125S 3ZT4S0000C 00016	HGM125S 4ZT4S0000C 00016	-
	20 A	HGM125S 2ZT4S0000C 00020	HGM125S 3ZT4S0000C 00020	HGM125S 4ZT4S0000C 00020	-
	25 A	HGM125S 2ZT4S0000C 00025	HGM125S 3ZT4S0000C 00025	HGM125S 4ZT4S0000C 00025	-
	32 A	HGM125S 2ZT4S0000C 00032	HGM125S 3ZT4S0000C 00032	HGM125S 4ZT4S0000C 00032	-
	40 A	HGM125S 2ZT4S0000C 00040	HGM125S 3ZT4S0000C 00040	HGM125S 4ZT4S0000C 00040	-
	50 A	HGM125S 2ZT4S0000C 00050	HGM125S 3ZT4S0000C 00050	HGM125S 4ZT4S0000C 00050	-
	63 A	HGM125S 2ZT4S0000C 00063	HGM125S 3ZT4S0000C 00063	HGM125S 4ZT4S0000C 00063	-
	75 A	HGM125S 2ZT4S0000C 00075	HGM125S 3ZT4S0000C 00075	HGM125S 4ZT4S0000C 00075	-
	80 A	HGM125S 2ZT4S0000C 00080	HGM125S 3ZT4S0000C 00080	HGM125S 4ZT4S0000C 00080	-
	100 A	HGM125S 2ZT4S0000C 00100	HGM125S 3ZT4S0000C 00100	HGM125S 4ZT4S0000C 00100	-
	125 A	HGM125S 2ZT4S0000C 00125	HGM125S 3ZT4S0000C 00125	HGM125S 4ZT4S0000C 00125	-
	HGM125H...38 kA / 460 V				
	16 A	HGM125H 2ZT4S0000C 00016	HGM125H 3ZT4S0000C 00016	HGM125H 4ZT4S0000C 00016	-
20 A	HGM125H 2ZT4S0000C 00020	HGM125H 3ZT4S0000C 00020	HGM125H 4ZT4S0000C 00020	-	
25 A	HGM125H 2ZT4S0000C 00025	HGM125H 3ZT4S0000C 00025	HGM125H 4ZT4S0000C 00025	-	
32 A	HGM125H 2ZT4S0000C 00032	HGM125H 3ZT4S0000C 00032	HGM125H 4ZT4S0000C 00032	-	
40 A	HGM125H 2ZT4S0000C 00040	HGM125H 3ZT4S0000C 00040	HGM125H 4ZT4S0000C 00040	-	
50 A	HGM125H 2ZT4S0000C 00050	HGM125H 3ZT4S0000C 00050	HGM125H 4ZT4S0000C 00050	-	
63 A	HGM125H 2ZT4S0000C 00063	HGM125H 3ZT4S0000C 00063	HGM125H 4ZT4S0000C 00063	-	
75 A	HGM125H 2ZT4S0000C 00075	HGM125H 3ZT4S0000C 00075	HGM125H 4ZT4S0000C 00075	-	
80 A	HGM125H 2ZT4S0000C 00080	HGM125H 3ZT4S0000C 00080	HGM125H 4ZT4S0000C 00080	-	
100 A	HGM125H 2ZT4S0000C 00100	HGM125H 3ZT4S0000C 00100	HGM125H 4ZT4S0000C 00100	-	
125 A	HGM125H 2ZT4S0000C 00125	HGM125H 3ZT4S0000C 00125	HGM125H 4ZT4S0000C 00125	-	
HGM125L...55 kA / 460 V					
16 A	HGM125L 2ZT4S0000C 00016	HGM125L 3ZT4S0000C 00016	HGM125L 4ZT4S0000C 00016	-	
20 A	HGM125L 2ZT4S0000C 00020	HGM125L 3ZT4S0000C 00020	HGM125L 4ZT4S0000C 00020	-	
25 A	HGM125L 2ZT4S0000C 00025	HGM125L 3ZT4S0000C 00025	HGM125L 4ZT4S0000C 00025	-	
32 A	HGM125L 2ZT4S0000C 00032	HGM125L 3ZT4S0000C 00032	HGM125L 4ZT4S0000C 00032	-	
40 A	HGM125L 2ZT4S0000C 00040	HGM125L 3ZT4S0000C 00040	HGM125L 4ZT4S0000C 00040	-	
50 A	HGM125L 2ZT4S0000C 00050	HGM125L 3ZT4S0000C 00050	HGM125L 4ZT4S0000C 00050	-	
63 A	HGM125L 2ZT4S0000C 00063	HGM125L 3ZT4S0000C 00063	HGM125L 4ZT4S0000C 00063	-	
75 A	HGM125L 2ZT4S0000C 00075	HGM125L 3ZT4S0000C 00075	HGM125L 4ZT4S0000C 00075	-	
80 A	HGM125L 2ZT4S0000C 00080	HGM125L 3ZT4S0000C 00080	HGM125L 4ZT4S0000C 00080	-	
100 A	HGM125L 2ZT4S0000C 00100	HGM125L 3ZT4S0000C 00100	HGM125L 4ZT4S0000C 00100	-	
125 A	HGM125L 2ZT4S0000C 00125	HGM125L 3ZT4S0000C 00125	HGM125L 4ZT4S0000C 00125	-	

160 AF	In	2 Pole	3 Pole	4 Pole (RSTN)	4 Pole (NRST)
	HGM160E...20 kA / 460 V				
	100 A	HGM160E 2ZT4S0000C 00100	HGM160E 3ZT4S0000C 00100	HGM160E 4ZT4S0000C 00100	-
	125 A	HGM160E 2ZT4S0000C 00125	HGM160E 3ZT4S0000C 00125	HGM160E 4ZT4S0000C 00125	-
	150 A	HGM160E 2ZT4S0000C 00150	HGM160E 3ZT4S0000C 00150	HGM160E 4ZT4S0000C 00150	-
	160 A	HGM160E 2ZT4S0000C 00160	HGM160E 3ZT4S0000C 00160	HGM160E 4ZT4S0000C 00160	-
	HGM160S...26 kA / 460 V				
	100 A	HGM160S 2ZT4S0000C 00100	HGM160S 3ZT4S0000C 00100	HGM160S 4ZT4S0000C 00100	-
	125 A	HGM160S 2ZT4S0000C 00125	HGM160S 3ZT4S0000C 00125	HGM160S 4ZT4S0000C 00125	-
	150 A	HGM160S 2ZT4S0000C 00150	HGM160S 3ZT4S0000C 00150	HGM160S 4ZT4S0000C 00150	-
	160 A	HGM160S 2ZT4S0000C 00160	HGM160S 3ZT4S0000C 00160	HGM160S 4ZT4S0000C 00160	-

160 AF	In	2 Pole	3 Pole	4 Pole (RSTN)	4 Pole (NRST)
	HGM160H...38 kA / 460 V				
	100 A	HGM160H 2ZT4S0000C 00100	HGM160H 3ZT4S0000C 00100	HGM160H 4ZT4S0000C 00100	-
	125 A	HGM160H 2ZT4S0000C 00125	HGM160H 3ZT4S0000C 00125	HGM160H 4ZT4S0000C 00125	-
	150 A	HGM160H 2ZT4S0000C 00150	HGM160H 3ZT4S0000C 00150	HGM160H 4ZT4S0000C 00150	-
	160 A	HGM160H 2ZT4S0000C 00160	HGM160H 3ZT4S0000C 00160	HGM160H 4ZT4S0000C 00160	-
	HGM160L...55 kA / 460 V				
	100 A	HGM160L 2ZT4S0000C 00100	HGM160L 3ZT4S0000C 00100	HGM160L 4ZT4S0000C 00100	-
	125 A	HGM160L 2ZT4S0000C 00125	HGM160L 3ZT4S0000C 00125	HGM160L 4ZT4S0000C 00125	-
	150 A	HGM160L 2ZT4S0000C 00150	HGM160L 3ZT4S0000C 00150	HGM160L 4ZT4S0000C 00150	-
	160 A	HGM160L 2ZT4S0000C 00160	HGM160L 3ZT4S0000C 00160	HGM160L 4ZT4S0000C 00160	-

250 AF	In	2 Pole	3 Pole	4 Pole (RSTN)	4 Pole (NRST)
	HGM250E...20 kA / 460 V				
	100 A	HGM250E 2ZT4S0000C 00100	HGM250E 3ZT4S0000C 00100	HGM250E 4ZT4S0000C 00100	-
	125 A	HGM250E 2ZT4S0000C 00125	HGM250E 3ZT4S0000C 00125	HGM250E 4ZT4S0000C 00125	-
	150 A	HGM250E 2ZT4S0000C 00150	HGM250E 3ZT4S0000C 00150	HGM250E 4ZT4S0000C 00150	-
	160 A	HGM250E 2ZT4S0000C 00160	HGM250E 3ZT4S0000C 00160	HGM250E 4ZT4S0000C 00160	-
	175 A	HGM250E 2ZT4S0000C 00175	HGM250E 3ZT4S0000C 00175	HGM250E 4ZT4S0000C 00175	-
	200 A	HGM250E 2ZT4S0000C 00200	HGM250E 3ZT4S0000C 00200	HGM250E 4ZT4S0000C 00200	-
	225 A	HGM250E 2ZT4S0000C 00225	HGM250E 3ZT4S0000C 00225	HGM250E 4ZT4S0000C 00225	-
	250 A	HGM250E 2ZT4S0000C 00250	HGM250E 3ZT4S0000C 00250	HGM250E 4ZT4S0000C 00250	-
	HGM250S...26 kA / 460 V				
	100 A	HGM250S 2ZT4S0000C 00100	HGM250S 3ZT4S0000C 00100	HGM250S 4ZT4S0000C 00100	-
	125 A	HGM250S 2ZT4S0000C 00125	HGM250S 3ZT4S0000C 00125	HGM250S 4ZT4S0000C 00125	-
	150 A	HGM250S 2ZT4S0000C 00150	HGM250S 3ZT4S0000C 00150	HGM250S 4ZT4S0000C 00150	-
	160 A	HGM250S 2ZT4S0000C 00160	HGM250S 3ZT4S0000C 00160	HGM250S 4ZT4S0000C 00160	-
	175 A	HGM250S 2ZT4S0000C 00175	HGM250S 3ZT4S0000C 00175	HGM250S 4ZT4S0000C 00175	-
	200 A	HGM250S 2ZT4S0000C 00200	HGM250S 3ZT4S0000C 00200	HGM250S 4ZT4S0000C 00200	-
	225 A	HGM250S 2ZT4S0000C 00225	HGM250S 3ZT4S0000C 00225	HGM250S 4ZT4S0000C 00225	-
	250 A	HGM250S 2ZT4S0000C 00250	HGM250S 3ZT4S0000C 00250	HGM250S 4ZT4S0000C 00250	-
	HGM250H...38 kA / 460 V				
	100 A	HGM250H 2ZT4S0000C 00100	HGM250H 3ZT4S0000C 00100	HGM250H 4ZT4S0000C 00100	-
	125 A	HGM250H 2ZT4S0000C 00125	HGM250H 3ZT4S0000C 00125	HGM250H 4ZT4S0000C 00125	-
	150 A	HGM250H 2ZT4S0000C 00150	HGM250H 3ZT4S0000C 00150	HGM250H 4ZT4S0000C 00150	-
	160 A	HGM250H 2ZT4S0000C 00160	HGM250H 3ZT4S0000C 00160	HGM250H 4ZT4S0000C 00160	-
	175 A	HGM250H 2ZT4S0000C 00175	HGM250H 3ZT4S0000C 00175	HGM250H 4ZT4S0000C 00175	-
	200 A	HGM250H 2ZT4S0000C 00200	HGM250H 3ZT4S0000C 00200	HGM250H 4ZT4S0000C 00200	-
	225 A	HGM250H 2ZT4S0000C 00225	HGM250H 3ZT4S0000C 00225	HGM250H 4ZT4S0000C 00225	-
	250 A	HGM250H 2ZT4S0000C 00250	HGM250H 3ZT4S0000C 00250	HGM250H 4ZT4S0000C 00250	-
	HGM250L...55 kA / 460 V				
	100 A	HGM250L 2ZT4S0000C 00100	HGM250L 3ZT4S0000C 00100	HGM250L 4ZT4S0000C 00100	-
	125 A	HGM250L 2ZT4S0000C 00125	HGM250L 3ZT4S0000C 00125	HGM250L 4ZT4S0000C 00125	-
	150 A	HGM250L 2ZT4S0000C 00150	HGM250L 3ZT4S0000C 00150	HGM250L 4ZT4S0000C 00150	-
	160 A	HGM250L 2ZT4S0000C 00160	HGM250L 3ZT4S0000C 00160	HGM250L 4ZT4S0000C 00160	-
	175 A	HGM250L 2ZT4S0000C 00175	HGM250L 3ZT4S0000C 00175	HGM250L 4ZT4S0000C 00175	-
	200 A	HGM250L 2ZT4S0000C 00200	HGM250L 3ZT4S0000C 00200	HGM250L 4ZT4S0000C 00200	-
	225 A	HGM250L 2ZT4S0000C 00225	HGM250L 3ZT4S0000C 00225	HGM250L 4ZT4S0000C 00225	-
	250 A	HGM250L 2ZT4S0000C 00250	HGM250L 3ZT4S0000C 00250	HGM250L 4ZT4S0000C 00250	-

Ordering Codes

HGM Type ZCT Molded Case Circuit Breakers (ZCT MCCB)

- Normal type/Front connection
- Except for accessory, Based on ambient temperature 40 °C and frequency 50/60 Hz



400 AF	In	2 Pole	3 Pole	4 Pole (RSTN)	4 Pole (NRST)
	HGM400E...38 kA / 460 V				
	250 A	HGM400E 2ZT4S0000C 00250	HGM400E 3ZT4S0000C 00250	HGM400E 4ZT4S0000C 00250	-
	300 A	HGM400E 2ZT4S0000C 00300	HGM400E 3ZT4S0000C 00300	HGM400E 4ZT4S0000C 00300	-
	350 A	HGM400E 2ZT4S0000C 00350	HGM400E 3ZT4S0000C 00350	HGM400E 4ZT4S0000C 00350	-
	400 A	HGM400E 2ZT4S0000C 00400	HGM400E 3ZT4S0000C 00400	HGM400E 4ZT4S0000C 00400	-
	HGM400S...50 kA / 460 V				
	250 A	HGM400S 2ZT4S0000C 00250	HGM400S 3ZT4S0000C 00250	HGM400S 4ZT4S0000C 00250	-
	300 A	HGM400S 2ZT4S0000C 00300	HGM400S 3ZT4S0000C 00300	HGM400S 4ZT4S0000C 00300	-
	350 A	HGM400S 2ZT4S0000C 00350	HGM400S 3ZT4S0000C 00350	HGM400S 4ZT4S0000C 00350	-
	400 A	HGM400S 2ZT4S0000C 00400	HGM400S 3ZT4S0000C 00400	HGM400S 4ZT4S0000C 00400	-
	HGM400H...70 kA / 460 V				
	250 A	HGM400H 2ZT4S0000C 00250	HGM400H 3ZT4S0000C 00250	HGM400H 4ZT4S0000C 00250	-
	300 A	HGM400H 2ZT4S0000C 00300	HGM400H 3ZT4S0000C 00300	HGM400H 4ZT4S0000C 00300	-
	350 A	HGM400H 2ZT4S0000C 00350	HGM400H 3ZT4S0000C 00350	HGM400H 4ZT4S0000C 00350	-
	400 A	HGM400H 2ZT4S0000C 00400	HGM400H 3ZT4S0000C 00400	HGM400H 4ZT4S0000C 00400	-
	HGM400L...85 kA / 460 V				
250 A	HGM400L 2ZT4S0000C 00250	HGM400L 3ZT4S0000C 00250	HGM400L 4ZT4S0000C 00250	-	
300 A	HGM400L 2ZT4S0000C 00300	HGM400L 3ZT4S0000C 00300	HGM400L 4ZT4S0000C 00300	-	
350 A	HGM400L 2ZT4S0000C 00350	HGM400L 3ZT4S0000C 00350	HGM400L 4ZT4S0000C 00350	-	
400 A	HGM400L 2ZT4S0000C 00400	HGM400L 3ZT4S0000C 00400	HGM400L 4ZT4S0000C 00400	-	

630 AF	In	2 Pole	3 Pole	4 Pole (RSTN)	4 Pole (NRST)
	HGM630E...38 kA / 460 V				
	500 A	HGM630E 2ZT4S0000C 00500	HGM630E 3ZT4S0000C 00500	-	-
	630 A	HGM630E 2ZT4S0000C 00630	HGM630E 3ZT4S0000C 00630	-	-
	HGM630S...50 kA / 460 V				
	500 A	HGM630S 2ZT4S0000C 00500	HGM630S 3ZT4S0000C 00500	-	-
	630 A	HGM630S 2ZT4S0000C 00630	HGM630S 3ZT4S0000C 00630	-	-
	HGM630H...70 kA / 460 V				
	500 A	HGM630H 2ZT4S0000C 00500	HGM630H 3ZT4S0000C 00500	-	-
	630 A	HGM630H 2ZT4S0000C 00630	HGM630H 3ZT4S0000C 00630	-	-
	HGM630L...85 kA / 460 V				
	500 A	HGM630L 2ZT4S0000C 00500	HGM630L 3ZT4S0000C 00500	-	-
	630 A	HGM630L 2ZT4S0000C 00630	HGM630L 3ZT4S0000C 00630	-	-

800 AF	In	2 Pole	3 Pole	4 Pole (RSTN)	4 Pole (NRST)
	HGM800S...50 kA / 460 V				
	700 A	HGM800S 2ZT4S0000C 00700	HGM800S 3ZT4S0000C 00700	-	-
	800 A	HGM800S 2ZT4S0000C 00800	HGM800S 3ZT4S0000C 00800	-	-
	HGM800H...70 kA / 460 V				
	700 A	HGM800H 2ZT4S0000C 00700	HGM800H 3ZT4S0000C 00700	-	-
	800 A	HGM800H 2ZT4S0000C 00800	HGM800H 3ZT4S0000C 00800	-	-
	HGM800L...85 kA / 460 V				
	700 A	HGM800L 2ZT4S0000C 00700	HGM800L 3ZT4S0000C 00700	-	-
	800 A	HGM800L 2ZT4S0000C 00800	HGM800L 3ZT4S0000C 00800	-	-

HGE Type Earth Leakage Circuit Breakers (ELCB)

- Normal type/Front connection
- Except for accessory, Based on ambient temperature 40 °C and frequency 50/60 Hz

32 AF	In	2 Pole	3 Pole	4 Pole (RSTN)	Rated Residual Current	
	HGE30E...16 kA / 460 V					
	16 A	HGE30E 2PG4S0000C 00016	HGE30E 3PG4S0000C 00016	HGE30E 4PG4S0000C 00016	Fixed residual type (30 mA) High speed type (Fixed operation time)	
	20 A	HGE30E 2PG4S0000C 00020	HGE30E 3PG4S0000C 00020	HGE30E 4PG4S0000C 00020		
	25 A	HGE30E 2PG4S0000C 00025	HGE30E 3PG4S0000C 00025	HGE30E 4PG4S0000C 00025		
	32 A	HGE30E 2PG4S0000C 00032	HGE30E 3PG4S0000C 00032	HGE30E 4PG4S0000C 00032		
	16 A	HGE30E 2PG5S0000C 00016	HGE30E 3PG5S0000C 00016	HGE30E 4PG5S0000C 00016	Adjustable residual type (100/300/500/1,000 mA) Time delay type (Settable delay time)	
	20 A	HGE30E 2PG5S0000C 00020	HGE30E 3PG5S0000C 00020	HGE30E 4PG5S0000C 00020		
	25 A	HGE30E 2PG5S0000C 00025	HGE30E 3PG5S0000C 00025	HGE30E 4PG5S0000C 00025		
	32 A	HGE30E 2PG5S0000C 00032	HGE30E 3PG5S0000C 00032	HGE30E 4PG5S0000C 00032		
	HGE30S...20 kA / 460 V					
	16 A	HGE30S 2PG4S0000C 00016	HGE30S 3PG4S0000C 00016	HGE30S 4PG4S0000C 00016	Fixed residual type (30 mA) High speed type (Fixed operation time)	
	20 A	HGE30S 2PG4S0000C 00020	HGE30S 3PG4S0000C 00020	HGE30S 4PG4S0000C 00020		
	25 A	HGE30S 2PG4S0000C 00025	HGE30S 3PG4S0000C 00025	HGE30S 4PG4S0000C 00025		
	32 A	HGE30S 2PG4S0000C 00032	HGE30S 3PG4S0000C 00032	HGE30S 4PG4S0000C 00032		
	16 A	HGE30S 2PG5S0000C 00016	HGE30S 3PG5S0000C 00016	HGE30S 4PG5S0000C 00016	Adjustable residual type (100/300/500/1,000 mA) Time delay type (Settable delay time)	
	20 A	HGE30S 2PG5S0000C 00020	HGE30S 3PG5S0000C 00020	HGE30S 4PG5S0000C 00020		
25 A	HGE30S 2PG5S0000C 00025	HGE30S 3PG5S0000C 00025	HGE30S 4PG5S0000C 00025			
32 A	HGE30S 2PG5S0000C 00032	HGE30S 3PG5S0000C 00032	HGE30S 4PG5S0000C 00032			
50 AF	In	2 Pole	3 Pole	4 Pole (RSTN)	Rated Residual Current	
	HGE50E...16 kA / 460 V					
	16 A	HGE50E 2PG4S0000C 00016	HGE50E 3PG4S0000C 00016	HGE50E 4PG4S0000C 00016	Fixed residual type (30mA) High speed type (Fixed operation time)	
	20 A	HGE50E 2PG4S0000C 00020	HGE50E 3PG4S0000C 00020	HGE50E 4PG4S0000C 00020		
	25 A	HGE50E 2PG4S0000C 00025	HGE50E 3PG4S0000C 00025	HGE50E 4PG4S0000C 00025		
	32 A	HGE50E 2PG4S0000C 00032	HGE50E 3PG4S0000C 00032	HGE50E 4PG4S0000C 00032		
	40 A	HGE50E 2PG4S0000C 00040	HGE50E 3PG4S0000C 00040	HGE50E 4PG4S0000C 00040		
	50 A	HGE50E 2PG4S0000C 00050	HGE50E 3PG4S0000C 00050	HGE50E 4PG4S0000C 00050		
	16 A	HGE50E 2PG5S0000C 00016	HGE50E 3PG5S0000C 00016	HGE50E 4PG5S0000C 00016	Adjustable residual type (100/300/500/1,000 mA) Time delay type (Settable delay time)	
	20 A	HGE50E 2PG5S0000C 00020	HGE50E 3PG5S0000C 00020	HGE50E 4PG5S0000C 00020		
	25 A	HGE50E 2PG5S0000C 00025	HGE50E 3PG5S0000C 00025	HGE50E 4PG5S0000C 00025		
	32 A	HGE50E 2PG5S0000C 00032	HGE50E 3PG5S0000C 00032	HGE50E 4PG5S0000C 00032		
	40 A	HGE50E 2PG5S0000C 00040	HGE50E 3PG5S0000C 00040	HGE50E 4PG5S0000C 00040		
	50 A	HGE50E 2PG5S0000C 00050	HGE50E 3PG5S0000C 00050	HGE50E 4PG5S0000C 00050		
	HGE50S...20 kA / 460 V					
	16 A	HGE50S 2PG4S0000C 00016	HGE50S 3PG4S0000C 00016	HGE50S 4PG4S0000C 00016	Fixed residual type (30 mA) High speed type (Fixed operation time)	
	20 A	HGE50S 2PG4S0000C 00020	HGE50S 3PG4S0000C 00020	HGE50S 4PG4S0000C 00020		
25 A	HGE50S 2PG4S0000C 00025	HGE50S 3PG4S0000C 00025	HGE50S 4PG4S0000C 00025			
32 A	HGE50S 2PG4S0000C 00032	HGE50S 3PG4S0000C 00032	HGE50S 4PG4S0000C 00032			
40 A	HGE50S 2PG4S0000C 00040	HGE50S 3PG4S0000C 00040	HGE50S 4PG4S0000C 00040			
50 A	HGE50S 2PG4S0000C 00050	HGE50S 3PG4S0000C 00050	HGE50S 4PG4S0000C 00050			
16 A	HGE50S 2PG5S0000C 00016	HGE50S 3PG5S0000C 00016	HGE50S 4PG5S0000C 00016	Adjustable residual type (100/300/500/1000mA) Time delay type (Settable delay time)		
20 A	HGE50S 2PG5S0000C 00020	HGE50S 3PG5S0000C 00020	HGE50S 4PG5S0000C 00020			
25 A	HGE50S 2PG5S0000C 00025	HGE50S 3PG5S0000C 00025	HGE50S 4PG5S0000C 00025			
32 A	HGE50S 2PG5S0000C 00032	HGE50S 3PG5S0000C 00032	HGE50S 4PG5S0000C 00032			
40 A	HGE50S 2PG5S0000C 00040	HGE50S 3PG5S0000C 00040	HGE50S 4PG5S0000C 00040			
50 A	HGE50S 2PG5S0000C 00050	HGE50S 3PG5S0000C 00050	HGE50S 4PG5S0000C 00050			

Ordering Codes

HGE Type Earth Leakage Circuit Breakers (ELCB)

- Normal type/Front connection
- Except for accessory, Based on ambient temperature 40 °C and frequency 50/60 Hz

50 AF	In	2 Pole	3 Pole	4 Pole (RSTN)	Rated Residual Current	
	HGE50H...38 kA / 460 V					
	16 A	HGE50H 2PG4S0000C 00016	HGE50H 3PG4S0000C 00016	HGE50H 4PG4S0000C 00016	Fixed residual type (30 mA) High speed type (Fixed operation time)	
	20 A	HGE50H 2PG4S0000C 00020	HGE50H 3PG4S0000C 00020	HGE50H 4PG4S0000C 00020		
	25 A	HGE50H 2PG4S0000C 00025	HGE50H 3PG4S0000C 00025	HGE50H 4PG4S0000C 00025		
	32 A	HGE50H 2PG4S0000C 00032	HGE50H 3PG4S0000C 00032	HGE50H 4PG4S0000C 00032		
	40 A	HGE50H 2PG4S0000C 00040	HGE50H 3PG4S0000C 00040	HGE50H 4PG4S0000C 00040		
	50 A	HGE50H 2PG4S0000C 00050	HGE50H 3PG4S0000C 00050	HGE50H 4PG4S0000C 00050	Adjustable residual type (100/300/500/1,000 mA) Time delay type (Settable delay time)	
	16 A	HGE50H 2PG5S0000C 00016	HGE50H 3PG5S0000C 00016	HGE50H 4PG5S0000C 00016		
	20 A	HGE50H 2PG5S0000C 00020	HGE50H 3PG5S0000C 00020	HGE50H 4PG5S0000C 00020		
	25 A	HGE50H 2PG5S0000C 00025	HGE50H 3PG5S0000C 00025	HGE50H 4PG5S0000C 00025		
	32 A	HGE50H 2PG5S0000C 00032	HGE50H 3PG5S0000C 00032	HGE50H 4PG5S0000C 00032		
	40 A	HGE50H 2PG5S0000C 00040	HGE50H 3PG5S0000C 00040	HGE50H 4PG5S0000C 00040	Adjustable residual type (100/300/500/1,000 mA) Time delay type (Settable delay time)	
	50 A	HGE50H 2PG5S0000C 00050	HGE50H 3PG5S0000C 00050	HGE50H 4PG5S0000C 00050		
	HGE50L...55 kA / 460 V					
	16 A	HGE50L 2PG4S0000C 00016	HGE50L 3PG4S0000C 00016	HGE50L 4PG4S0000C 00016		Fixed residual type (30 mA) High speed type (Fixed operation time)
	20 A	HGE50L 2PG4S0000C 00020	HGE50L 3PG4S0000C 00020	HGE50L 4PG4S0000C 00020		
	25 A	HGE50L 2PG4S0000C 00025	HGE50L 3PG4S0000C 00025	HGE50L 4PG4S0000C 00025		
	32 A	HGE50L 2PG4S0000C 00032	HGE50L 3PG4S0000C 00032	HGE50L 4PG4S0000C 00032		
	40 A	HGE50L 2PG4S0000C 00040	HGE50L 3PG4S0000C 00040	HGE50L 4PG4S0000C 00040		
	50 A	HGE50L 2PG4S0000C 00050	HGE50L 3PG4S0000C 00050	HGE50L 4PG4S0000C 00050	Adjustable residual type (100/300/500/1,000 mA) Time delay type (Settable delay time)	
16 A	HGE50L 2PG5S0000C 00016	HGE50L 3PG5S0000C 00016	HGE50L 4PG5S0000C 00016			
20 A	HGE50L 2PG5S0000C 00020	HGE50L 3PG5S0000C 00020	HGE50L 4PG5S0000C 00020			
25 A	HGE50L 2PG5S0000C 00025	HGE50L 3PG5S0000C 00025	HGE50L 4PG5S0000C 00025			
32 A	HGE50L 2PG5S0000C 00032	HGE50L 3PG5S0000C 00032	HGE50L 4PG5S0000C 00032			
40 A	HGE50L 2PG5S0000C 00040	HGE50L 3PG5S0000C 00040	HGE50L 4PG5S0000C 00040	Adjustable residual type (100/300/500/1,000 mA) Time delay type (Settable delay time)		
50 A	HGE50L 2PG5S0000C 00050	HGE50L 3PG5S0000C 00050	HGE50L 4PG5S0000C 00050			

63 AF	In	2 Pole	3 Pole	4 Pole (RSTN)	Rated Residual Current
	HGE60E...16 kA / 460 V				
	16 A	HGE60E 2PG4S0000C 00016	HGE60E 3PG4S0000C 00016	HGE60E 4PG4S0000C 00016	Fixed residual type (30 mA) High speed type (Fixed operation time)
	20 A	HGE60E 2PG4S0000C 00020	HGE60E 3PG4S0000C 00020	HGE60E 4PG4S0000C 00020	
	25 A	HGE60E 2PG4S0000C 00025	HGE60E 3PG4S0000C 00025	HGE60E 4PG4S0000C 00025	
	32 A	HGE60E 2PG4S0000C 00032	HGE60E 3PG4S0000C 00032	HGE60E 4PG4S0000C 00032	
	40 A	HGE60E 2PG4S0000C 00040	HGE60E 3PG4S0000C 00040	HGE60E 4PG4S0000C 00040	
	50 A	HGE60E 2PG4S0000C 00050	HGE60E 3PG4S0000C 00050	HGE60E 4PG4S0000C 00050	Adjustable residual type (100/300/500/1,000 mA) Time delay type (Settable delay time)
	63 A	HGE60E 2PG4S0000C 00063	HGE60E 3PG4S0000C 00063	HGE60E 4PG4S0000C 00063	
	16 A	HGE60E 2PG5S0000C 00016	HGE60E 3PG5S0000C 00016	HGE60E 4PG5S0000C 00016	
	20 A	HGE60E 2PG5S0000C 00020	HGE60E 3PG5S0000C 00020	HGE60E 4PG5S0000C 00020	
	25 A	HGE60E 2PG5S0000C 00025	HGE60E 3PG5S0000C 00025	HGE60E 4PG5S0000C 00025	
	32 A	HGE60E 2PG5S0000C 00032	HGE60E 3PG5S0000C 00032	HGE60E 4PG5S0000C 00032	Adjustable residual type (100/300/500/1,000 mA) Time delay type (Settable delay time)
	40 A	HGE60E 2PG5S0000C 00040	HGE60E 3PG5S0000C 00040	HGE60E 4PG5S0000C 00040	
	50 A	HGE60E 2PG5S0000C 00050	HGE60E 3PG5S0000C 00050	HGE60E 4PG5S0000C 00050	
	63 A	HGE60E 2PG5S0000C 00063	HGE60E 3PG5S0000C 00063	HGE60E 4PG5S0000C 00063	

63 AF	In	2 Pole	3 Pole	4 Pole (RSTN)	Rated Residual Current	
	HGE60S...20 kA / 460 V					
	16 A	HGE60S 2PG4S0000C 00016	HGE60S 3PG4S0000C 00016	HGE60S 4PG4S0000C 00016	Fixed residual type (30 mA) High speed type (Fixed operation time)	
	20 A	HGE60S 2PG4S0000C 00020	HGE60S 3PG4S0000C 00020	HGE60S 4PG4S0000C 00020		
	25 A	HGE60S 2PG4S0000C 00025	HGE60S 3PG4S0000C 00025	HGE60S 4PG4S0000C 00025		
	32 A	HGE60S 2PG4S0000C 00032	HGE60S 3PG4S0000C 00032	HGE60S 4PG4S0000C 00032		
	40 A	HGE60S 2PG4S0000C 00040	HGE60S 3PG4S0000C 00040	HGE60S 4PG4S0000C 00040		
	50 A	HGE60S 2PG4S0000C 00050	HGE60S 3PG4S0000C 00050	HGE60S 4PG4S0000C 00050		
	63 A	HGE60S 2PG4S0000C 00063	HGE60S 3PG4S0000C 00063	HGE60S 4PG4S0000C 00063		
	16 A	HGE60S 2PG5S0000C 00016	HGE60S 3PG5S0000C 00016	HGE60S 4PG5S0000C 00016	Adjustable residual type (100/300/500/1,000 mA) Time delay type (Settable delay time)	
	20 A	HGE60S 2PG5S0000C 00020	HGE60S 3PG5S0000C 00020	HGE60S 4PG5S0000C 00020		
	25 A	HGE60S 2PG5S0000C 00025	HGE60S 3PG5S0000C 00025	HGE60S 4PG5S0000C 00025		
	32 A	HGE60S 2PG5S0000C 00032	HGE60S 3PG5S0000C 00032	HGE60S 4PG5S0000C 00032		
	40 A	HGE60S 2PG5S0000C 00040	HGE60S 3PG5S0000C 00040	HGE60S 4PG5S0000C 00040		
	50 A	HGE60S 2PG5S0000C 00050	HGE60S 3PG5S0000C 00050	HGE60S 4PG5S0000C 00050		
	63 A	HGE60S 2PG5S0000C 00063	HGE60S 3PG5S0000C 00063	HGE60S 4PG5S0000C 00063		
	HGE60H...26 kA / 460 V					
	16 A	HGE60H 2PG4S0000C 00016	HGE60H 3PG4S0000C 00016	HGE60H 4PG4S0000C 00016	Fixed residual type (30 mA) High speed type (Fixed operation time)	
	20 A	HGE60H 2PG4S0000C 00020	HGE60H 3PG4S0000C 00020	HGE60H 4PG4S0000C 00020		
	25 A	HGE60H 2PG4S0000C 00025	HGE60H 3PG4S0000C 00025	HGE60H 4PG4S0000C 00025		
	32 A	HGE60H 2PG4S0000C 00032	HGE60H 3PG4S0000C 00032	HGE60H 4PG4S0000C 00032		
	40 A	HGE60H 2PG4S0000C 00040	HGE60H 3PG4S0000C 00040	HGE60H 4PG4S0000C 00040		
	50 A	HGE60H 2PG4S0000C 00050	HGE60H 3PG4S0000C 00050	HGE60H 4PG4S0000C 00050		
	63 A	HGE60H 2PG4S0000C 00063	HGE60H 3PG4S0000C 00063	HGE60H 4PG4S0000C 00063		
	16 A	HGE60H 2PG5S0000C 00016	HGE60H 3PG5S0000C 00016	HGE60H 4PG5S0000C 00016	Adjustable residual type (100/300/500/1,000 mA) Time delay type (Settable delay time)	
20 A	HGE60H 2PG5S0000C 00020	HGE60H 3PG5S0000C 00020	HGE60H 4PG5S0000C 00020			
25 A	HGE60H 2PG5S0000C 00025	HGE60H 3PG5S0000C 00025	HGE60H 4PG5S0000C 00025			
32 A	HGE60H 2PG5S0000C 00032	HGE60H 3PG5S0000C 00032	HGE60H 4PG5S0000C 00032			
40 A	HGE60H 2PG5S0000C 00040	HGE60H 3PG5S0000C 00040	HGE60H 4PG5S0000C 00040			
50 A	HGE60H 2PG5S0000C 00050	HGE60H 3PG5S0000C 00050	HGE60H 4PG5S0000C 00050			
63 A	HGE60H 2PG5S0000C 00063	HGE60H 3PG5S0000C 00063	HGE60H 4PG5S0000C 00063			
HGE60L...30 kA / 460 V						
16 A	HGE60L 2PG4S0000C 00016	HGE60L 3PG4S0000C 00016	HGE60L 4PG4S0000C 00016	Fixed residual type (30 mA) High speed type (Fixed operation time)		
20 A	HGE60L 2PG4S0000C 00020	HGE60L 3PG4S0000C 00020	HGE60L 4PG4S0000C 00020			
25 A	HGE60L 2PG4S0000C 00025	HGE60L 3PG4S0000C 00025	HGE60L 4PG4S0000C 00025			
32 A	HGE60L 2PG4S0000C 00032	HGE60L 3PG4S0000C 00032	HGE60L 4PG4S0000C 00032			
40 A	HGE60L 2PG4S0000C 00040	HGE60L 3PG4S0000C 00040	HGE60L 4PG4S0000C 00040			
50 A	HGE60L 2PG4S0000C 00050	HGE60L 3PG4S0000C 00050	HGE60L 4PG4S0000C 00050			
63 A	HGE60L 2PG4S0000C 00063	HGE60L 3PG4S0000C 00063	HGE60L 4PG4S0000C 00063			
16 A	HGE60L 2PG5S0000C 00016	HGE60L 3PG5S0000C 00016	HGE60L 4PG5S0000C 00016	Adjustable residual type (100/300/500/1,000 mA) Time delay type (Settable delay time)		
20 A	HGE60L 2PG5S0000C 00020	HGE60L 3PG5S0000C 00020	HGE60L 4PG5S0000C 00020			
25 A	HGE60L 2PG5S0000C 00025	HGE60L 3PG5S0000C 00025	HGE60L 4PG5S0000C 00025			
32 A	HGE60L 2PG5S0000C 00032	HGE60L 3PG5S0000C 00032	HGE60L 4PG5S0000C 00032			
40 A	HGE60L 2PG5S0000C 00040	HGE60L 3PG5S0000C 00040	HGE60L 4PG5S0000C 00040			
50 A	HGE60L 2PG5S0000C 00050	HGE60L 3PG5S0000C 00050	HGE60L 4PG5S0000C 00050			
63 A	HGE60L 2PG5S0000C 00063	HGE60L 3PG5S0000C 00063	HGE60L 4PG5S0000C 00063			

Ordering Codes

HGE Type Earth Leakage Circuit Breakers (ELCB)

- Normal type/Front connection
- Except for accessory, Based on ambient temperature 40 °C and frequency 50/60 Hz

100 AF	In	2 Pole	3 Pole	4 Pole (RSTN)	Rated Residual Current	
	HGE100E...16 kA / 460 V					
	16 A	HGE100E 2PG4S0000C 00016	HGE100E 3PG4S0000C 00016	HGE100E 4PG4S0000C 00016	Fixed residual type (30 mA) High speed type (Fixed operation time)	
	20 A	HGE100E 2PG4S0000C 00020	HGE100E 3PG4S0000C 00020	HGE100E 4PG4S0000C 00020		
	25 A	HGE100E 2PG4S0000C 00025	HGE100E 3PG4S0000C 00025	HGE100E 4PG4S0000C 00025		
	32 A	HGE100E 2PG4S0000C 00032	HGE100E 3PG4S0000C 00032	HGE100E 4PG4S0000C 00032		
	40 A	HGE100E 2PG4S0000C 00040	HGE100E 3PG4S0000C 00040	HGE100E 4PG4S0000C 00040		
	50 A	HGE100E 2PG4S0000C 00050	HGE100E 3PG4S0000C 00050	HGE100E 4PG4S0000C 00050		
	63 A	HGE100E 2PG4S0000C 00063	HGE100E 3PG4S0000C 00063	HGE100E 4PG4S0000C 00063		
	75 A	HGE100E 2PG4S0000C 00075	HGE100E 3PG4S0000C 00075	HGE100E 4PG4S0000C 00075		
	80 A	HGE100E 2PG4S0000C 00080	HGE100E 3PG4S0000C 00080	HGE100E 4PG4S0000C 00080		
	100 A	HGE100E 2PG4S0000C 00100	HGE100E 3PG4S0000C 00100	HGE100E 4PG4S0000C 00100		
	16 A	HGE100E 2PG5S0000C 00016	HGE100E 3PG5S0000C 00016	HGE100E 4PG5S0000C 00016	Adjustable residual type (100/300/500/1,000 mA) Time delay type (Settable delay time)	
	20 A	HGE100E 2PG5S0000C 00020	HGE100E 3PG5S0000C 00020	HGE100E 4PG5S0000C 00020		
	25 A	HGE100E 2PG5S0000C 00025	HGE100E 3PG5S0000C 00025	HGE100E 4PG5S0000C 00025		
	32 A	HGE100E 2PG5S0000C 00032	HGE100E 3PG5S0000C 00032	HGE100E 4PG5S0000C 00032		
	40 A	HGE100E 2PG5S0000C 00040	HGE100E 3PG5S0000C 00040	HGE100E 4PG5S0000C 00040		
	50 A	HGE100E 2PG5S0000C 00050	HGE100E 3PG5S0000C 00050	HGE100E 4PG5S0000C 00050		
	63 A	HGE100E 2PG5S0000C 00063	HGE100E 3PG5S0000C 00063	HGE100E 4PG5S0000C 00063		
	75 A	HGE100E 2PG5S0000C 00075	HGE100E 3PG5S0000C 00075	HGE100E 4PG5S0000C 00075		
	80 A	HGE100E 2PG5S0000C 00080	HGE100E 3PG5S0000C 00080	HGE100E 4PG5S0000C 00080		
	100 A	HGE100E 2PG5S0000C 00100	HGE100E 3PG5S0000C 00100	HGE100E 4PG5S0000C 00100		
	HGE100S...20 kA / 460 V					
	16 A	HGE100S 2PG4S0000C 00016	HGE100S 3PG4S0000C 00016	HGE100S 4PG4S0000C 00016	Fixed residual type (30m A) High speed type (Fixed operation time)	
	20 A	HGE100S 2PG4S0000C 00020	HGE100S 3PG4S0000C 00020	HGE100S 4PG4S0000C 00020		
	25 A	HGE100S 2PG4S0000C 00025	HGE100S 3PG4S0000C 00025	HGE100S 4PG4S0000C 00025		
	32 A	HGE100S 2PG4S0000C 00032	HGE100S 3PG4S0000C 00032	HGE100S 4PG4S0000C 00032		
	40 A	HGE100S 2PG4S0000C 00040	HGE100S 3PG4S0000C 00040	HGE100S 4PG4S0000C 00040		
	50 A	HGE100S 2PG4S0000C 00050	HGE100S 3PG4S0000C 00050	HGE100S 4PG4S0000C 00050		
	63 A	HGE100S 2PG4S0000C 00063	HGE100S 3PG4S0000C 00063	HGE100S 4PG4S0000C 00063		
	75 A	HGE100S 2PG4S0000C 00075	HGE100S 3PG4S0000C 00075	HGE100S 4PG4S0000C 00075		
	80 A	HGE100S 2PG4S0000C 00080	HGE100S 3PG4S0000C 00080	HGE100S 4PG4S0000C 00080		
	100 A	HGE100S 2PG4S0000C 00100	HGE100S 3PG4S0000C 00100	HGE100S 4PG4S0000C 00100		
	16 A	HGE100S 2PG5S0000C 00016	HGE100S 3PG5S0000C 00016	HGE100S 4PG5S0000C 00016	Adjustable residual type (100/300/500/1,000 mA) Time delay type (Settable delay time)	
	20 A	HGE100S 2PG5S0000C 00020	HGE100S 3PG5S0000C 00020	HGE100S 4PG5S0000C 00020		
25 A	HGE100S 2PG5S0000C 00025	HGE100S 3PG5S0000C 00025	HGE100S 4PG5S0000C 00025			
32 A	HGE100S 2PG5S0000C 00032	HGE100S 3PG5S0000C 00032	HGE100S 4PG5S0000C 00032			
40 A	HGE100S 2PG5S0000C 00040	HGE100S 3PG5S0000C 00040	HGE100S 4PG5S0000C 00040			
50 A	HGE100S 2PG5S0000C 00050	HGE100S 3PG5S0000C 00050	HGE100S 4PG5S0000C 00050			
63 A	HGE100S 2PG5S0000C 00063	HGE100S 3PG5S0000C 00063	HGE100S 4PG5S0000C 00063			
75 A	HGE100S 2PG5S0000C 00075	HGE100S 3PG5S0000C 00075	HGE100S 4PG5S0000C 00075			
80 A	HGE100S 2PG5S0000C 00080	HGE100S 3PG5S0000C 00080	HGE100S 4PG5S0000C 00080			
100 A	HGE100S 2PG5S0000C 00100	HGE100S 3PG5S0000C 00100	HGE100S 4PG5S0000C 00100			

100 AF	In	2 Pole	3 Pole	4 Pole (RSTN)	Rated Residual Current
	HGE100H...26 kA / 460 V				
	16 A	HGE100H 2PG4S0000C 00016	HGE100H 3PG4S0000C 00016	HGE100H 4PG4S0000C 00016	Fixed residual type (30 mA) High speed type (Fixed operation time)
	20 A	HGE100H 2PG4S0000C 00020	HGE100H 3PG4S0000C 00020	HGE100H 4PG4S0000C 00020	
	25 A	HGE100H 2PG4S0000C 00025	HGE100H 3PG4S0000C 00025	HGE100H 4PG4S0000C 00025	
	32 A	HGE100H 2PG4S0000C 00032	HGE100H 3PG4S0000C 00032	HGE100H 4PG4S0000C 00032	
	40 A	HGE100H 2PG4S0000C 00040	HGE100H 3PG4S0000C 00040	HGE100H 4PG4S0000C 00040	
	50 A	HGE100H 2PG4S0000C 00050	HGE100H 3PG4S0000C 00050	HGE100H 4PG4S0000C 00050	
	63 A	HGE100H 2PG4S0000C 00063	HGE100H 3PG4S0000C 00063	HGE100H 4PG4S0000C 00063	
	75 A	HGE100H 2PG4S0000C 00075	HGE100H 3PG4S0000C 00075	HGE100H 4PG4S0000C 00075	
	80 A	HGE100H 2PG4S0000C 00080	HGE100H 3PG4S0000C 00080	HGE100H 4PG4S0000C 00080	
100 A	HGE100H 2PG4S0000C 00100	HGE100H 3PG4S0000C 00100	HGE100H 4PG4S0000C 00100		
	HGE100L...30 kA / 460 V				
	16 A	HGE100L 2PG4S0000C 00016	HGE100L 3PG4S0000C 00016	HGE100L 4PG4S0000C 00016	Fixed residual type (30 mA) High speed type (Fixed operation time)
	20 A	HGE100L 2PG4S0000C 00020	HGE100L 3PG4S0000C 00020	HGE100L 4PG4S0000C 00020	
	25 A	HGE100L 2PG4S0000C 00025	HGE100L 3PG4S0000C 00025	HGE100L 4PG4S0000C 00025	
	32 A	HGE100L 2PG4S0000C 00032	HGE100L 3PG4S0000C 00032	HGE100L 4PG4S0000C 00032	
	40 A	HGE100L 2PG4S0000C 00040	HGE100L 3PG4S0000C 00040	HGE100L 4PG4S0000C 00040	
	50 A	HGE100L 2PG4S0000C 00050	HGE100L 3PG4S0000C 00050	HGE100L 4PG4S0000C 00050	
	63 A	HGE100L 2PG4S0000C 00063	HGE100L 3PG4S0000C 00063	HGE100L 4PG4S0000C 00063	
	75 A	HGE100L 2PG4S0000C 00075	HGE100L 3PG4S0000C 00075	HGE100L 4PG4S0000C 00075	
	80 A	HGE100L 2PG4S0000C 00080	HGE100L 3PG4S0000C 00080	HGE100L 4PG4S0000C 00080	
100 A	HGE100L 2PG4S0000C 00100	HGE100L 3PG4S0000C 00100	HGE100L 4PG4S0000C 00100		
	HGE100L...30 kA / 460 V				
	16 A	HGE100L 2PG5S0000C 00016	HGE100L 3PG5S0000C 00016	HGE100L 4PG5S0000C 00016	Adjustable residual type (100/300/500/1,000 mA) Time delay type (Settable delay time)
	20 A	HGE100L 2PG5S0000C 00020	HGE100L 3PG5S0000C 00020	HGE100L 4PG5S0000C 00020	
	25 A	HGE100L 2PG5S0000C 00025	HGE100L 3PG5S0000C 00025	HGE100L 4PG5S0000C 00025	
	32 A	HGE100L 2PG5S0000C 00032	HGE100L 3PG5S0000C 00032	HGE100L 4PG5S0000C 00032	
	40 A	HGE100L 2PG5S0000C 00040	HGE100L 3PG5S0000C 00040	HGE100L 4PG5S0000C 00040	
	50 A	HGE100L 2PG5S0000C 00050	HGE100L 3PG5S0000C 00050	HGE100L 4PG5S0000C 00050	
	63 A	HGE100L 2PG5S0000C 00063	HGE100L 3PG5S0000C 00063	HGE100L 4PG5S0000C 00063	
	75 A	HGE100L 2PG5S0000C 00075	HGE100L 3PG5S0000C 00075	HGE100L 4PG5S0000C 00075	
	80 A	HGE100L 2PG5S0000C 00080	HGE100L 3PG5S0000C 00080	HGE100L 4PG5S0000C 00080	
100 A	HGE100L 2PG5S0000C 00100	HGE100L 3PG5S0000C 00100	HGE100L 4PG5S0000C 00100		

Ordering Codes

HGE Type Earth Leakage Circuit Breakers (ELCB)

- Normal type/Front connection
- Except for accessory, Based on ambient temperature 40 °C and frequency 50/60 Hz

125 AF	In	2 Pole	3 Pole	4 Pole (RSTN)	Rated Residual Current	
	HGE125E...20 kA / 460 V					
	16 A	HGE125E 2PG4S0000C 00016	HGE125E 3PG4S0000C 00016	HGE125E 4PG4S0000C 00016	Fixed residual type (30 mA) High speed type (Fixed operation time)	
	20 A	HGE125E 2PG4S0000C 00020	HGE125E 3PG4S0000C 00020	HGE125E 4PG4S0000C 00020		
	25 A	HGE125E 2PG4S0000C 00025	HGE125E 3PG4S0000C 00025	HGE125E 4PG4S0000C 00025		
	32 A	HGE125E 2PG4S0000C 00032	HGE125E 3PG4S0000C 00032	HGE125E 4PG4S0000C 00032		
	40 A	HGE125E 2PG4S0000C 00040	HGE125E 3PG4S0000C 00040	HGE125E 4PG4S0000C 00040		
	50 A	HGE125E 2PG4S0000C 00050	HGE125E 3PG4S0000C 00050	HGE125E 4PG4S0000C 00050		
	63 A	HGE125E 2PG4S0000C 00063	HGE125E 3PG4S0000C 00063	HGE125E 4PG4S0000C 00063		
	75 A	HGE125E 2PG4S0000C 00075	HGE125E 3PG4S0000C 00075	HGE125E 4PG4S0000C 00075		
	80 A	HGE125E 2PG4S0000C 00080	HGE125E 3PG4S0000C 00080	HGE125E 4PG4S0000C 00080		
	100 A	HGE125E 2PG4S0000C 00100	HGE125E 3PG4S0000C 00100	HGE125E 4PG4S0000C 00100		
	125 A	HGE125E 2PG4S0000C 00125	HGE125E 3PG4S0000C 00125	HGE125E 4PG4S0000C 00125		
	16 A	HGE125E 2PG5S0000C 00016	HGE125E 3PG5S0000C 00016	HGE125E 4PG5S0000C 00016		Adjustable residual type (100/300/500/1,000 mA) Time delay type (Settable delay time)
	20 A	HGE125E 2PG5S0000C 00020	HGE125E 3PG5S0000C 00020	HGE125E 4PG5S0000C 00020		
	25 A	HGE125E 2PG5S0000C 00025	HGE125E 3PG5S0000C 00025	HGE125E 4PG5S0000C 00025		
	32 A	HGE125E 2PG5S0000C 00032	HGE125E 3PG5S0000C 00032	HGE125E 4PG5S0000C 00032		
	40 A	HGE125E 2PG5S0000C 00040	HGE125E 3PG5S0000C 00040	HGE125E 4PG5S0000C 00040		
	50 A	HGE125E 2PG5S0000C 00050	HGE125E 3PG5S0000C 00050	HGE125E 4PG5S0000C 00050		
	63 A	HGE125E 2PG5S0000C 00063	HGE125E 3PG5S0000C 00063	HGE125E 4PG5S0000C 00063		
	75 A	HGE125E 2PG5S0000C 00075	HGE125E 3PG5S0000C 00075	HGE125E 4PG5S0000C 00075		
	80 A	HGE125E 2PG5S0000C 00080	HGE125E 3PG5S0000C 00080	HGE125E 4PG5S0000C 00080		
	100 A	HGE125E 2PG5S0000C 00100	HGE125E 3PG5S0000C 00100	HGE125E 4PG5S0000C 00100		
	125 A	HGE125E 2PG5S0000C 00125	HGE125E 3PG5S0000C 00125	HGE125E 4PG5S0000C 00125		
	HGE125S...26 kA / 460 V					
	16 A	HGE125S 2PG4S0000C 00016	HGE125S 3PG4S0000C 00016	HGE125S 4PG4S0000C 00016	Fixed residual type (30 mA) High speed type (Fixed operation time)	
	20 A	HGE125S 2PG4S0000C 00020	HGE125S 3PG4S0000C 00020	HGE125S 4PG4S0000C 00020		
	25 A	HGE125S 2PG4S0000C 00025	HGE125S 3PG4S0000C 00025	HGE125S 4PG4S0000C 00025		
	32 A	HGE125S 2PG4S0000C 00032	HGE125S 3PG4S0000C 00032	HGE125S 4PG4S0000C 00032		
	40 A	HGE125S 2PG4S0000C 00040	HGE125S 3PG4S0000C 00040	HGE125S 4PG4S0000C 00040		
	50 A	HGE125S 2PG4S0000C 00050	HGE125S 3PG4S0000C 00050	HGE125S 4PG4S0000C 00050		
63 A	HGE125S 2PG4S0000C 00063	HGE125S 3PG4S0000C 00063	HGE125S 4PG4S0000C 00063			
75 A	HGE125S 2PG4S0000C 00075	HGE125S 3PG4S0000C 00075	HGE125S 4PG4S0000C 00075			
80 A	HGE125S 2PG4S0000C 00080	HGE125S 3PG4S0000C 00080	HGE125S 4PG4S0000C 00080			
100 A	HGE125S 2PG4S0000C 00100	HGE125S 3PG4S0000C 00100	HGE125S 4PG4S0000C 00100			
125 A	HGE125S 2PG4S0000C 00125	HGE125S 3PG4S0000C 00125	HGE125S 4PG4S0000C 00125			
16 A	HGE125S 2PG5S0000C 00016	HGE125S 3PG5S0000C 00016	HGE125S 4PG5S0000C 00016	Adjustable residual type (100/300/500/1,000 mA) Time delay type (Settable delay time)		
20 A	HGE125S 2PG5S0000C 00020	HGE125S 3PG5S0000C 00020	HGE125S 4PG5S0000C 00020			
25 A	HGE125S 2PG5S0000C 00025	HGE125S 3PG5S0000C 00025	HGE125S 4PG5S0000C 00025			
32 A	HGE125S 2PG5S0000C 00032	HGE125S 3PG5S0000C 00032	HGE125S 4PG5S0000C 00032			
40 A	HGE125S 2PG5S0000C 00040	HGE125S 3PG5S0000C 00040	HGE125S 4PG5S0000C 00040			
50 A	HGE125S 2PG5S0000C 00050	HGE125S 3PG5S0000C 00050	HGE125S 4PG5S0000C 00050			
63 A	HGE125S 2PG5S0000C 00063	HGE125S 3PG5S0000C 00063	HGE125S 4PG5S0000C 00063			
75 A	HGE125S 2PG5S0000C 00075	HGE125S 3PG5S0000C 00075	HGE125S 4PG5S0000C 00075			
80 A	HGE125S 2PG5S0000C 00080	HGE125S 3PG5S0000C 00080	HGE125S 4PG5S0000C 00080			
100 A	HGE125S 2PG5S0000C 00100	HGE125S 3PG5S0000C 00100	HGE125S 4PG5S0000C 00100			
125 A	HGE125S 2PG5S0000C 00125	HGE125S 3PG5S0000C 00125	HGE125S 4PG5S0000C 00125			

125 AF	In	2 Pole	3 Pole	4 Pole (RSTN)	Rated Residual Current	
	HGE125H...38 kA / 460 V					
	16 A	HGE125H 2PG4S0000C 00016	HGE125H 3PG4S0000C 00016	HGE125H 4PG4S0000C 00016	Fixed residual type (30 mA) High speed type (Fixed operation time)	
	20 A	HGE125H 2PG4S0000C 00020	HGE125H 3PG4S0000C 00020	HGE125H 4PG4S0000C 00020		
	25 A	HGE125H 2PG4S0000C 00025	HGE125H 3PG4S0000C 00025	HGE125H 4PG4S0000C 00025		
	32 A	HGE125H 2PG4S0000C 00032	HGE125H 3PG4S0000C 00032	HGE125H 4PG4S0000C 00032		
	40 A	HGE125H 2PG4S0000C 00040	HGE125H 3PG4S0000C 00040	HGE125H 4PG4S0000C 00040		
	50 A	HGE125H 2PG4S0000C 00050	HGE125H 3PG4S0000C 00050	HGE125H 4PG4S0000C 00050		
	63 A	HGE125H 2PG4S0000C 00063	HGE125H 3PG4S0000C 00063	HGE125H 4PG4S0000C 00063		
	75 A	HGE125H 2PG4S0000C 00075	HGE125H 3PG4S0000C 00075	HGE125H 4PG4S0000C 00075		
	80 A	HGE125H 2PG4S0000C 00080	HGE125H 3PG4S0000C 00080	HGE125H 4PG4S0000C 00080		
	100 A	HGE125H 2PG4S0000C 00100	HGE125H 3PG4S0000C 00100	HGE125H 4PG4S0000C 00100		
	125 A	HGE125H 2PG4S0000C 00125	HGE125H 3PG4S0000C 00125	HGE125H 4PG4S0000C 00125		
	16 A	HGE125H 2PG5S0000C 00016	HGE125H 3PG5S0000C 00016	HGE125H 4PG5S0000C 00016		Adjustable residual type (100/300/500/1,000 mA) Time delay type (Settable delay time)
	20 A	HGE125H 2PG5S0000C 00020	HGE125H 3PG5S0000C 00020	HGE125H 4PG5S0000C 00020		
	25 A	HGE125H 2PG5S0000C 00025	HGE125H 3PG5S0000C 00025	HGE125H 4PG5S0000C 00025		
	32 A	HGE125H 2PG5S0000C 00032	HGE125H 3PG5S0000C 00032	HGE125H 4PG5S0000C 00032		
	40 A	HGE125H 2PG5S0000C 00040	HGE125H 3PG5S0000C 00040	HGE125H 4PG5S0000C 00040		
	50 A	HGE125H 2PG5S0000C 00050	HGE125H 3PG5S0000C 00050	HGE125H 4PG5S0000C 00050		
	63 A	HGE125H 2PG5S0000C 00063	HGE125H 3PG5S0000C 00063	HGE125H 4PG5S0000C 00063		
	75 A	HGE125H 2PG5S0000C 00075	HGE125H 3PG5S0000C 00075	HGE125H 4PG5S0000C 00075		
	80 A	HGE125H 2PG5S0000C 00080	HGE125H 3PG5S0000C 00080	HGE125H 4PG5S0000C 00080		
	100 A	HGE125H 2PG5S0000C 00100	HGE125H 3PG5S0000C 00100	HGE125H 4PG5S0000C 00100		
	125 A	HGE125H 2PG5S0000C 00125	HGE125H 3PG5S0000C 00125	HGE125H 4PG5S0000C 00125		
	HGE125L...55 kA / 460 V					
	16 A	HGE125L 2PG4S0000C 00016	HGE125L 3PG4S0000C 00016	HGE125L 4PG4S0000C 00016	Fixed residual type (30 mA) High speed type (Fixed operation time)	
	20 A	HGE125L 2PG4S0000C 00020	HGE125L 3PG4S0000C 00020	HGE125L 4PG4S0000C 00020		
	25 A	HGE125L 2PG4S0000C 00025	HGE125L 3PG4S0000C 00025	HGE125L 4PG4S0000C 00025		
	32 A	HGE125L 2PG4S0000C 00032	HGE125L 3PG4S0000C 00032	HGE125L 4PG4S0000C 00032		
	40 A	HGE125L 2PG4S0000C 00040	HGE125L 3PG4S0000C 00040	HGE125L 4PG4S0000C 00040		
	50 A	HGE125L 2PG4S0000C 00050	HGE125L 3PG4S0000C 00050	HGE125L 4PG4S0000C 00050		
	63 A	HGE125L 2PG4S0000C 00063	HGE125L 3PG4S0000C 00063	HGE125L 4PG4S0000C 00063		
	75 A	HGE125L 2PG4S0000C 00075	HGE125L 3PG4S0000C 00075	HGE125L 4PG4S0000C 00075		
	80 A	HGE125L 2PG4S0000C 00080	HGE125L 3PG4S0000C 00080	HGE125L 4PG4S0000C 00080		
	100 A	HGE125L 2PG4S0000C 00100	HGE125L 3PG4S0000C 00100	HGE125L 4PG4S0000C 00100		
	125 A	HGE125L 2PG4S0000C 00125	HGE125L 3PG4S0000C 00125	HGE125L 4PG4S0000C 00125		
	16 A	HGE125L 2PG5S0000C 00016	HGE125L 3PG5S0000C 00016	HGE125L 4PG5S0000C 00016		Adjustable residual type (100/300/500/1,000 mA) Time delay type (Settable delay time)
20 A	HGE125L 2PG5S0000C 00020	HGE125L 3PG5S0000C 00020	HGE125L 4PG5S0000C 00020			
25 A	HGE125L 2PG5S0000C 00025	HGE125L 3PG5S0000C 00025	HGE125L 4PG5S0000C 00025			
32 A	HGE125L 2PG5S0000C 00032	HGE125L 3PG5S0000C 00032	HGE125L 4PG5S0000C 00032			
40 A	HGE125L 2PG5S0000C 00040	HGE125L 3PG5S0000C 00040	HGE125L 4PG5S0000C 00040			
50 A	HGE125L 2PG5S0000C 00050	HGE125L 3PG5S0000C 00050	HGE125L 4PG5S0000C 00050			
63 A	HGE125L 2PG5S0000C 00063	HGE125L 3PG5S0000C 00063	HGE125L 4PG5S0000C 00063			
75 A	HGE125L 2PG5S0000C 00075	HGE125L 3PG5S0000C 00075	HGE125L 4PG5S0000C 00075			
80 A	HGE125L 2PG5S0000C 00080	HGE125L 3PG5S0000C 00080	HGE125L 4PG5S0000C 00080			
100 A	HGE125L 2PG5S0000C 00100	HGE125L 3PG5S0000C 00100	HGE125L 4PG5S0000C 00100			
125 A	HGE125L 2PG5S0000C 00125	HGE125L 3PG5S0000C 00125	HGE125L 4PG5S0000C 00125			

Ordering Codes

HGE Type Earth Leakage Circuit Breakers (ELCB)

- Normal type/Front connection
- Except for accessory, Based on ambient temperature 40 °C and frequency 50/60 Hz

160 AF	In	2 Pole	3 Pole	4 Pole (RSTN)	Rated Residual Current	
	HGE160E...20 kA / 460 V					
	100 A	HGE160E 2PG4S0000C 00100	HGE160E 3PG4S0000C 00100	HGE160E 4PG4S0000C 00100	Fixed residual type (30 mA) High speed type (Fixed operation time)	
	125 A	HGE160E 2PG4S0000C 00125	HGE160E 3PG4S0000C 00125	HGE160E 4PG4S0000C 00125		
	150 A	HGE160E 2PG4S0000C 00150	HGE160E 3PG4S0000C 00150	HGE160E 4PG4S0000C 00150		
	160 A	HGE160E 2PG4S0000C 00160	HGE160E 3PG4S0000C 00160	HGE160E 4PG4S0000C 00160		
	100 A	HGE160E 2PG5S0000C 00100	HGE160E 3PG5S0000C 00100	HGE160E 4PG5S0000C 00100	Adjustable residual type (100/300/500/1,000 mA) Time delay type (Settable delay time)	
	125 A	HGE160E 2PG5S0000C 00125	HGE160E 3PG5S0000C 00125	HGE160E 4PG5S0000C 00125		
	150 A	HGE160E 2PG5S0000C 00150	HGE160E 3PG5S0000C 00150	HGE160E 4PG5S0000C 00150		
	160 A	HGE160E 2PG5S0000C 00160	HGE160E 3PG5S0000C 00160	HGE160E 4PG5S0000C 00160		
	HGE160S...26 kA / 460 V					
	100 A	HGE160S 2PG4S0000C 00100	HGE160S 3PG4S0000C 00100	HGE160S 4PG4S0000C 00100	Fixed residual type (30 mA) High speed type (Fixed operation time)	
	125 A	HGE160S 2PG4S0000C 00125	HGE160S 3PG4S0000C 00125	HGE160S 4PG4S0000C 00125		
	150 A	HGE160S 2PG4S0000C 00150	HGE160S 3PG4S0000C 00150	HGE160S 4PG4S0000C 00150		
	160 A	HGE160S 2PG4S0000C 00160	HGE160S 3PG4S0000C 00160	HGE160S 4PG4S0000C 00160		
	100 A	HGE160S 2PG5S0000C 00100	HGE160S 3PG5S0000C 00100	HGE160S 4PG5S0000C 00100	Adjustable residual type (100/300/500/1,000 mA) Time delay type (Settable delay time)	
	125 A	HGE160S 2PG5S0000C 00125	HGE160S 3PG5S0000C 00125	HGE160S 4PG5S0000C 00125		
	150 A	HGE160S 2PG5S0000C 00150	HGE160S 3PG5S0000C 00150	HGE160S 4PG5S0000C 00150		
	160 A	HGE160S 2PG5S0000C 00160	HGE160S 3PG5S0000C 00160	HGE160S 4PG5S0000C 00160		
	HGE160H...38 kA / 460 V					
	100 A	HGE160H 2PG4S0000C 00100	HGE160H 3PG4S0000C 00100	HGE160H 4PG4S0000C 00100	Fixed residual type (30 mA) High speed type (Fixed operation time)	
	125 A	HGE160H 2PG4S0000C 00125	HGE160H 3PG4S0000C 00125	HGE160H 4PG4S0000C 00125		
	150 A	HGE160H 2PG4S0000C 00150	HGE160H 3PG4S0000C 00150	HGE160H 4PG4S0000C 00150		
	160 A	HGE160H 2PG4S0000C 00160	HGE160H 3PG4S0000C 00160	HGE160H 4PG4S0000C 00160		
	100 A	HGE160H 2PG5S0000C 00100	HGE160H 3PG5S0000C 00100	HGE160H 4PG5S0000C 00100	Adjustable residual type (100/300/500/1,000 mA) Time delay type (Settable delay time)	
	125 A	HGE160H 2PG5S0000C 00125	HGE160H 3PG5S0000C 00125	HGE160H 4PG5S0000C 00125		
	150 A	HGE160H 2PG5S0000C 00150	HGE160H 3PG5S0000C 00150	HGE160H 4PG5S0000C 00150		
	160 A	HGE160H 2PG5S0000C 00160	HGE160H 3PG5S0000C 00160	HGE160H 4PG5S0000C 00160		
	HGE160L...55 kA / 460 V					
100 A	HGE160L 2PG4S0000C 00100	HGE160L 3PG4S0000C 00100	HGE160L 4PG4S0000C 00100	Fixed residual type (30 mA) High speed type (Fixed operation time)		
125 A	HGE160L 2PG4S0000C 00125	HGE160L 3PG4S0000C 00125	HGE160L 4PG4S0000C 00125			
150 A	HGE160L 2PG4S0000C 00150	HGE160L 3PG4S0000C 00150	HGE160L 4PG4S0000C 00150			
160 A	HGE160L 2PG4S0000C 00160	HGE160L 3PG4S0000C 00160	HGE160L 4PG4S0000C 00160			
100 A	HGE160L 2PG5S0000C 00100	HGE160L 3PG5S0000C 00100	HGE160L 4PG5S0000C 00100	Adjustable residual type (100/300/500/1,000 mA) Time delay type (Settable delay time)		
125 A	HGE160L 2PG5S0000C 00125	HGE160L 3PG5S0000C 00125	HGE160L 4PG5S0000C 00125			
150 A	HGE160L 2PG5S0000C 00150	HGE160L 3PG5S0000C 00150	HGE160L 4PG5S0000C 00150			
160 A	HGE160L 2PG5S0000C 00160	HGE160L 3PG5S0000C 00160	HGE160L 4PG5S0000C 00160			

250 AF	In	2 Pole	3 Pole	4 Pole (RSTN)	Rated Residual Current	
	HGE250E...20 kA / 460 V					
	100 A	HGE250E 2PG4S0000C 00100	HGE250E 3PG4S0000C 00100	HGE250E 4PG4S0000C 00100	Fixed residual type (30 mA) High speed type (Fixed operation time)	
	125 A	HGE250E 2PG4S0000C 00125	HGE250E 3PG4S0000C 00125	HGE250E 4PG4S0000C 00125		
	150 A	HGE250E 2PG4S0000C 00150	HGE250E 3PG4S0000C 00150	HGE250E 4PG4S0000C 00150		
	160 A	HGE250E 2PG4S0000C 00160	HGE250E 3PG4S0000C 00160	HGE250E 4PG4S0000C 00160		
	175 A	HGE250E 2PG4S0000C 00175	HGE250E 3PG4S0000C 00175	HGE250E 4PG4S0000C 00175		
	200 A	HGE250E 2PG4S0000C 00200	HGE250E 3PG4S0000C 00200	HGE250E 4PG4S0000C 00200		
	225 A	HGE250E 2PG4S0000C 00225	HGE250E 3PG4S0000C 00225	HGE250E 4PG4S0000C 00225		
	250 A	HGE250E 2PG4S0000C 00250	HGE250E 3PG4S0000C 00250	HGE250E 4PG4S0000C 00250		
	100 A	HGE250E 2PG5S0000C 00100	HGE250E 3PG5S0000C 00100	HGE250E 4PG5S0000C 00100	Adjustable residual type (100/300/500/1,000 mA) Time delay type (Settable delay time)	
	125 A	HGE250E 2PG5S0000C 00125	HGE250E 3PG5S0000C 00125	HGE250E 4PG5S0000C 00125		
	150 A	HGE250E 2PG5S0000C 00150	HGE250E 3PG5S0000C 00150	HGE250E 4PG5S0000C 00150		
	160 A	HGE250E 2PG5S0000C 00160	HGE250E 3PG5S0000C 00160	HGE250E 4PG5S0000C 00160		
	175 A	HGE250E 2PG5S0000C 00175	HGE250E 3PG5S0000C 00175	HGE250E 4PG5S0000C 00175		
	200 A	HGE250E 2PG5S0000C 00200	HGE250E 3PG5S0000C 00200	HGE250E 4PG5S0000C 00200		
	225 A	HGE250E 2PG5S0000C 00225	HGE250E 3PG5S0000C 00225	HGE250E 4PG5S0000C 00225		
	250 A	HGE250E 2PG5S0000C 00250	HGE250E 3PG5S0000C 00250	HGE250E 4PG5S0000C 00250		
	HGE250S...26 kA / 460 V					
	100 A	HGE250S 2PG4S0000C 00100	HGE250S 3PG4S0000C 00100	HGE250S 4PG4S0000C 00100	Fixed residual type (30 mA) High speed type (Fixed operation time)	
	125 A	HGE250S 2PG4S0000C 00125	HGE250S 3PG4S0000C 00125	HGE250S 4PG4S0000C 00125		
	150 A	HGE250S 2PG4S0000C 00150	HGE250S 3PG4S0000C 00150	HGE250S 4PG4S0000C 00150		
	160 A	HGE250S 2PG4S0000C 00160	HGE250S 3PG4S0000C 00160	HGE250S 4PG4S0000C 00160		
	175 A	HGE250S 2PG4S0000C 00175	HGE250S 3PG4S0000C 00175	HGE250S 4PG4S0000C 00175		
	200 A	HGE250S 2PG4S0000C 00200	HGE250S 3PG4S0000C 00200	HGE250S 4PG4S0000C 00200		
	225 A	HGE250S 2PG4S0000C 00225	HGE250S 3PG4S0000C 00225	HGE250S 4PG4S0000C 00225		
	250 A	HGE250S 2PG4S0000C 00250	HGE250S 3PG4S0000C 00250	HGE250S 4PG4S0000C 00250		
	100 A	HGE250S 2PG5S0000C 00100	HGE250S 3PG5S0000C 00100	HGE250S 4PG5S0000C 00100	Adjustable residual type (100/300/500/1,000 mA) Time delay type (Settable delay time)	
	125 A	HGE250S 2PG5S0000C 00125	HGE250S 3PG5S0000C 00125	HGE250S 4PG5S0000C 00125		
150 A	HGE250S 2PG5S0000C 00150	HGE250S 3PG5S0000C 00150	HGE250S 4PG5S0000C 00150			
160 A	HGE250S 2PG5S0000C 00160	HGE250S 3PG5S0000C 00160	HGE250S 4PG5S0000C 00160			
175 A	HGE250S 2PG5S0000C 00175	HGE250S 3PG5S0000C 00175	HGE250S 4PG5S0000C 00175			
200 A	HGE250S 2PG5S0000C 00200	HGE250S 3PG5S0000C 00200	HGE250S 4PG5S0000C 00200			
225 A	HGE250S 2PG5S0000C 00225	HGE250S 3PG5S0000C 00225	HGE250S 4PG5S0000C 00225			
250 A	HGE250S 2PG5S0000C 00250	HGE250S 3PG5S0000C 00250	HGE250S 4PG5S0000C 00250			

Ordering Codes

HGE Type Earth Leakage Circuit Breakers (ELCB)

- Normal type/Front connection
- Except for accessory, Based on ambient temperature 40 °C and frequency 50/60 Hz



250 AF	In	2 Pole	3 Pole	4 Pole (RSTN)	Rated Residual Current	
	HGE250H...38 kA / 460 V					
	100 A	HGE250H 2PG4S0000C 00100	HGE250H 3PG4S0000C 00100	HGE250H 4PG4S0000C 00100	Fixed residual type (30 mA) High speed type (Fixed operation time)	
	125 A	HGE250H 2PG4S0000C 00125	HGE250H 3PG4S0000C 00125	HGE250H 4PG4S0000C 00125		
	150 A	HGE250H 2PG4S0000C 00150	HGE250H 3PG4S0000C 00150	HGE250H 4PG4S0000C 00150		
	160 A	HGE250H 2PG4S0000C 00160	HGE250H 3PG4S0000C 00160	HGE250H 4PG4S0000C 00160		
	175 A	HGE250H 2PG4S0000C 00175	HGE250H 3PG4S0000C 00175	HGE250H 4PG4S0000C 00175		
	200 A	HGE250H 2PG4S0000C 00200	HGE250H 3PG4S0000C 00200	HGE250H 4PG4S0000C 00200		
	225 A	HGE250H 2PG4S0000C 00225	HGE250H 3PG4S0000C 00225	HGE250H 4PG4S0000C 00225		
	250 A	HGE250H 2PG4S0000C 00250	HGE250H 3PG4S0000C 00250	HGE250H 4PG4S0000C 00250		
	100 A	HGE250H 2PG5S0000C 00100	HGE250H 3PG5S0000C 00100	HGE250H 4PG5S0000C 00100	Adjustable residual type (100/300/500/1,000 mA) Time delay type (Settable delay time)	
	125 A	HGE250H 2PG5S0000C 00125	HGE250H 3PG5S0000C 00125	HGE250H 4PG5S0000C 00125		
	150 A	HGE250H 2PG5S0000C 00150	HGE250H 3PG5S0000C 00150	HGE250H 4PG5S0000C 00150		
	160 A	HGE250H 2PG5S0000C 00160	HGE250H 3PG5S0000C 00160	HGE250H 4PG5S0000C 00160		
	175 A	HGE250H 2PG5S0000C 00175	HGE250H 3PG5S0000C 00175	HGE250H 4PG5S0000C 00175		
	200 A	HGE250H 2PG5S0000C 00200	HGE250H 3PG5S0000C 00200	HGE250H 4PG5S0000C 00200		
	225 A	HGE250H 2PG5S0000C 00225	HGE250H 3PG5S0000C 00225	HGE250H 4PG5S0000C 00225		
	250 A	HGE250H 2PG5S0000C 00250	HGE250H 3PG5S0000C 00250	HGE250H 4PG5S0000C 00250		
	HGE250L...55 kA / 460 V					
	100 A	HGE250L 2PG4S0000C 00100	HGE250L 3PG4S0000C 00100	HGE250L 4PG4S0000C 00100	Fixed residual type (30 mA) High speed type (Fixed operation time)	
	125 A	HGE250L 2PG4S0000C 00125	HGE250L 3PG4S0000C 00125	HGE250L 4PG4S0000C 00125		
	150 A	HGE250L 2PG4S0000C 00150	HGE250L 3PG4S0000C 00150	HGE250L 4PG4S0000C 00150		
	160 A	HGE250L 2PG4S0000C 00160	HGE250L 3PG4S0000C 00160	HGE250L 4PG4S0000C 00160		
	175 A	HGE250L 2PG4S0000C 00175	HGE250L 3PG4S0000C 00175	HGE250L 4PG4S0000C 00175		
	200 A	HGE250L 2PG4S0000C 00200	HGE250L 3PG4S0000C 00200	HGE250L 4PG4S0000C 00200		
	225 A	HGE250L 2PG4S0000C 00225	HGE250L 3PG4S0000C 00225	HGE250L 4PG4S0000C 00225		
	250 A	HGE250L 2PG4S0000C 00250	HGE250L 3PG4S0000C 00250	HGE250L 4PG4S0000C 00250		
	100 A	HGE250L 2PG5S0000C 00100	HGE250L 3PG5S0000C 00100	HGE250L 4PG5S0000C 00100	Adjustable residual type (100/300/500/1,000 mA) Time delay type (Settable delay time)	
	125 A	HGE250L 2PG5S0000C 00125	HGE250L 3PG5S0000C 00125	HGE250L 4PG5S0000C 00125		
150 A	HGE250L 2PG5S0000C 00150	HGE250L 3PG5S0000C 00150	HGE250L 4PG5S0000C 00150			
160 A	HGE250L 2PG5S0000C 00160	HGE250L 3PG5S0000C 00160	HGE250L 4PG5S0000C 00160			
175 A	HGE250L 2PG5S0000C 00175	HGE250L 3PG5S0000C 00175	HGE250L 4PG5S0000C 00175			
200 A	HGE250L 2PG5S0000C 00200	HGE250L 3PG5S0000C 00200	HGE250L 4PG5S0000C 00200			
225 A	HGE250L 2PG5S0000C 00225	HGE250L 3PG5S0000C 00225	HGE250L 4PG5S0000C 00225			
250 A	HGE250L 2PG5S0000C 00250	HGE250L 3PG5S0000C 00250	HGE250L 4PG5S0000C 00250			

400 AF	In	2 Pole	3 Pole	4 Pole (RSTN)	Rated Residual Current
	HGE400E...38 kA / 460 V				
	250 A	HGE400E 2PG4S0000C 00250	HGE400E 3PG4S0000C 00250	HGE400E 4PG4S0000C 00250	Fixed residual type (30 mA) High speed type (Fixed operation time)
	300 A	HGE400E 2PG4S0000C 00300	HGE400E 3PG4S0000C 00300	HGE400E 4PG4S0000C 00300	
	350 A	HGE400E 2PG4S0000C 00350	HGE400E 3PG4S0000C 00350	HGE400E 4PG4S0000C 00350	
	400 A	HGE400E 2PG4S0000C 00400	HGE400E 3PG4S0000C 00400	HGE400E 4PG4S0000C 00400	
	250 A	HGE400E 2PG5S0000C 00250	HGE400E 3PG5S0000C 00250	HGE400E 4PG5S0000C 00250	Adjustable residual type (100/300/500/1,000 mA) Time delay type (Settable delay time)
	300 A	HGE400E 2PG5S0000C 00300	HGE400E 3PG5S0000C 00300	HGE400E 4PG5S0000C 00300	
	350 A	HGE400E 2PG5S0000C 00350	HGE400E 3PG5S0000C 00350	HGE400E 4PG5S0000C 00350	
	400 A	HGE400E 2PG5S0000C 00400	HGE400E 3PG5S0000C 00400	HGE400E 4PG5S0000C 00400	
	HGE400S...50 kA / 460 V				
	250 A	HGE400S 2PG4S0000C 00250	HGE400S 3PG4S0000C 00250	HGE400S 4PG4S0000C 00250	Fixed residual type (30 mA) High speed type (Fixed operation time)
	300 A	HGE400S 2PG4S0000C 00300	HGE400S 3PG4S0000C 00300	HGE400S 4PG4S0000C 00300	
	350 A	HGE400S 2PG4S0000C 00350	HGE400S 3PG4S0000C 00350	HGE400S 4PG4S0000C 00350	
	400 A	HGE400S 2PG4S0000C 00400	HGE400S 3PG4S0000C 00400	HGE400S 4PG4S0000C 00400	
	250 A	HGE400S 2PG5S0000C 00250	HGE400S 3PG5S0000C 00250	HGE400S 4PG5S0000C 00250	Adjustable residual type (100/300/500/1,000 mA) Time delay type (Settable delay time)
	300 A	HGE400S 2PG5S0000C 00300	HGE400S 3PG5S0000C 00300	HGE400S 4PG5S0000C 00300	
350 A	HGE400S 2PG5S0000C 00350	HGE400S 3PG5S0000C 00350	HGE400S 4PG5S0000C 00350		
400 A	HGE400S 2PG5S0000C 00400	HGE400S 3PG5S0000C 00400	HGE400S 4PG5S0000C 00400		
HGE400H...70 kA / 460 V					
250 A	HGE400H 2PG4S0000C 00250	HGE400H 3PG4S0000C 00250	HGE400H 4PG4S0000C 00250	Fixed residual type (30 mA) High speed type (Fixed operation time)	
300 A	HGE400H 2PG4S0000C 00300	HGE400H 3PG4S0000C 00300	HGE400H 4PG4S0000C 00300		
350 A	HGE400H 2PG4S0000C 00350	HGE400H 3PG4S0000C 00350	HGE400H 4PG4S0000C 00350		
400 A	HGE400H 2PG4S0000C 00400	HGE400H 3PG4S0000C 00400	HGE400H 4PG4S0000C 00400		
250 A	HGE400H 2PG5S0000C 00250	HGE400H 3PG5S0000C 00250	HGE400H 4PG5S0000C 00250	Adjustable residual type (100/300/500/1,000 mA) Time delay type (Settable delay time)	
300 A	HGE400H 2PG5S0000C 00300	HGE400H 3PG5S0000C 00300	HGE400H 4PG5S0000C 00300		
350 A	HGE400H 2PG5S0000C 00350	HGE400H 3PG5S0000C 00350	HGE400H 4PG5S0000C 00350		
400 A	HGE400H 2PG5S0000C 00400	HGE400H 3PG5S0000C 00400	HGE400H 4PG5S0000C 00400		
HGE400L...85 kA / 460 V					
250 A	HGE400L 2PG4S0000C 00250	HGE400L 3PG4S0000C 00250	HGE400L 4PG4S0000C 00250	Fixed residual type (30 mA) High speed type (Fixed operation time)	
300 A	HGE400L 2PG4S0000C 00300	HGE400L 3PG4S0000C 00300	HGE400L 4PG4S0000C 00300		
350 A	HGE400L 2PG4S0000C 00350	HGE400L 3PG4S0000C 00350	HGE400L 4PG4S0000C 00350		
400 A	HGE400L 2PG4S0000C 00400	HGE400L 3PG4S0000C 00400	HGE400L 4PG4S0000C 00400		
250 A	HGE400L 2PG5S0000C 00250	HGE400L 3PG5S0000C 00250	HGE400L 4PG5S0000C 00250	Adjustable residual type (100/300/500/1,000 mA) Time delay type (Settable delay time)	
300 A	HGE400L 2PG5S0000C 00300	HGE400L 3PG5S0000C 00300	HGE400L 4PG5S0000C 00300		
350 A	HGE400L 2PG5S0000C 00350	HGE400L 3PG5S0000C 00350	HGE400L 4PG5S0000C 00350		
400 A	HGE400L 2PG5S0000C 00400	HGE400L 3PG5S0000C 00400	HGE400L 4PG5S0000C 00400		

Ordering Codes

HGE Type Earth Leakage Circuit Breakers (ELCB)

- Normal type/Front connection
- Except for accessory, Based on ambient temperature 40 °C and frequency 50/60 Hz

630 AF	In	2 Pole	3 Pole	Rated Residual Current	
	HGE630E...38 kA / 460 V				
	500 A	HGE630E 2PG4S0000C 00500	HGE630E 3PG4S0000C 00500	Fixed residual type (30 mA)	
	630 A	HGE630E 2PG4S0000C 00630	HGE630E 3PG4S0000C 00630	High speed type (Fixed operation time)	
	500 A	HGE630E 2PG5S0000C 00500	HGE630E 3PG5S0000C 00500	Adjustable residual type (100/300/500/1,000 mA)	
	630 A	HGE630E 2PG5S0000C 00630	HGE630E 3PG5S0000C 00630	Time delay type (Settable delay time)	
	HGE630S...50 kA / 460 V				
	500 A	HGE630S 2PG4S0000C 00500	HGE630S 3PG4S0000C 00500	Fixed residual type (30 mA)	
	630 A	HGE630S 2PG4S0000C 00630	HGE630S 3PG4S0000C 00630	High speed type (Fixed operation time)	
	500 A	HGE630S 2PG5S0000C 00500	HGE630S 3PG5S0000C 00500	Adjustable residual type (100/300/500/1,000 mA)	
	630 A	HGE630S 2PG5S0000C 00630	HGE630S 3PG5S0000C 00630	Time delay type (Settable delay time)	
	HGE630H...70 kA / 460 V				
	500 A	HGE630H 2PG4S0000C 00500	HGE630H 3PG4S0000C 00500	Fixed residual type (30 mA)	
	630 A	HGE630H 2PG4S0000C 00630	HGE630H 3PG4S0000C 00630	High speed type (Fixed operation time)	
	500 A	HGE630H 2PG5S0000C 00500	HGE630H 3PG5S0000C 00500	Adjustable residual type (100/300/500/1,000 mA)	
	630 A	HGE630H 2PG5S0000C 00630	HGE630H 3PG5S0000C 00630	Time delay type (Settable delay time)	
	HGE630L...85 kA / 460 V				
	500 A	HGE630L 2PG4S0000C 00500	HGE630L 3PG4S0000C 00500	Fixed residual type (30 mA)	
	630 A	HGE630L 2PG4S0000C 00630	HGE630L 3PG4S0000C 00630	High speed type (Fixed operation time)	
	500 A	HGE630L 2PG5S0000C 00500	HGE630L 3PG5S0000C 00500	Adjustable residual type (100/300/500/1,000 mA)	
	630 A	HGE630L 2PG5S0000C 00630	HGE630L 3PG5S0000C 00630	Time delay type (Settable delay time)	
	800 AF	In	2 Pole	3 Pole	Rated Residual Current
		HGE800S...50 kA / 460 V			
		700 A	HGE800S 2PG4S0000C 00700	HGE800S 3PG4S0000C 00700	Fixed residual type (30 mA)
		800 A	HGE800S 2PG4S0000C 00800	HGE800S 3PG4S0000C 00800	High speed type (Fixed operation time)
700 A		HGE800S 2PG5S0000C 00700	HGE800S 3PG5S0000C 00700	Adjustable residual type (100/300/500/1,000 mA)	
800 A		HGE800S 2PG5S0000C 00800	HGE800S 3PG5S0000C 00800	Time delay type (Settable delay time)	
HGE800H...70 kA / 460 V					
700 A		HGE800H 2PG4S0000C 00700	HGE800H 3PG4S0000C 00700	Fixed residual type (30 mA)	
800 A		HGE800H 2PG4S0000C 00800	HGE800H 3PG4S0000C 00800	High speed type (Fixed operation time)	
700 A		HGE800H 2PG5S0000C 00700	HGE800H 3PG5S0000C 00700	Adjustable residual type (100/300/500/1,000 mA)	
800 A		HGE800H 2PG5S0000C 00800	HGE800H 3PG5S0000C 00800	Time delay type (Settable delay time)	
HGE800L...85 kA / 460 V					
700 A		HGE800L 2PG4S0000C 00700	HGE800L 3PG4S0000C 00700	Fixed residual type (30 mA)	
800 A		HGE800L 2PG4S0000C 00800	HGE800L 3PG4S0000C 00800	High speed type (Fixed operation time)	
700 A		HGE800L 2PG5S0000C 00700	HGE800L 3PG5S0000C 00700	Adjustable residual type (100/300/500/1,000 mA)	
800 A		HGE800L 2PG5S0000C 00800	HGE800L 3PG5S0000C 00800	Time delay type (Settable delay time)	

HGM/HGE Type Accessory Separately

HGM/HGE30, 50E/S, 60, 100

Mounting

		2 Pole	3 Pole	4 Pole
Plug-in	TDM (LINE/LOAD)	-	TDM 10GM P3	-
	TDM (LINE Only)	-	TDM 10GM F3	-
	TDF (LINE Only)	-	TDF 10GM 3	-
	TDA (1 row)	-	TDA 10GM S3	-
	TDA (2 row)	TDA 10GM D2	TDA 10GM D3	-
Conn. block (CBM)		CBM 10GM 2P UNIT	CBM 10GM UNIT	-
Terminal busbar (TBB)	Straight busbar	-	-	-
	Extended busbar	-	-	-
Rear terminal (RCT)	(≤ 50 A)	RCT 05GM F2	RCT 05GM F3	RCT 05GM F4
	(> 50 A)	RCT 10GM F2	RCT 10GM F3	RCT 10GM F4
Cage termina (CTB)	(≤ 50 A) inch TYPE	CTB 10GM 2S50	CTB 10GM 3S50	CTB 10GM 4S50
	(> 50 A) inch TYPE	CTB 10GM 2S100	CTB 10GM 3S100	CTB 10GM 4S100
	(≤ 50 A) mm TYPE	CTB 10GM 2S50 - MM	CTB 10GM 3S50 - MM	CTB 10GM 4S50 - MM
	(> 50 A) mm TYPE	CTB 10GM 2S100 - MM	CTB 10GM 3S100 - MM	CTB 10GM 4S100 - MM
DIN rail adapter (DRA)		DRA 10GM	DRA 10GM	DRA 10GM

Internal Accessory

	Auxiliary Switch (AUX)	Alarm Switch (ALT)	Auxiliary/Alarm Switch (AXT)
Indication contacts	AUX 10GM C1	ALT 10GM L1	AXT 10GM L1
	AUX 10GM C2	ALT 10GM R1	AXT 10GM R1
	Shunt Trip (SHT)	Undervoltage (UVT)	
Remote tripping	SHT 10GM DC24 V	UVT 10GM DC24 V	
	SHT 10GM DC100 - 120 V	UVT 10GM DC100 - 125 V	
	SHT 10GM DC48 V	UVT 10GM DC48 V	
	SHT 10GM DC60 V	UVT 10GM AC100 - 120 V	
	SHT 10GM DC125 V	UVT 10GM AC200 - 230 V	
	SHT 10GM AC100 - 120 V	UVT 10GM AC380 - 415 V	
	SHT 10GM AC200 - 250 V	UVT 10GM AC440 - 480 V	
	SHT 10GM AC380 - 480 V	-	

External Accessory

		Front Type (TFG)	Extended Type (TFH)	
Rotary handle	Up - Line	TFG 10GM U	TFH 10GM	
	Right - Line	TFG 10GM R	TFH 10GM	
	Left - Line	TFG 10GM L	TFH 10GM	
		2 Pole	3 Pole	4 Pole
Motor operator ¹⁾		-	MOT 10GM DC24V	
		-	MOT 10GM AC/DC110V	
		-	MOT 10GM AC/DC240V	
Terminal cover	Small	TCF 10GM S2	TCF 10GM S3	TCF 10GM S4
	Large	TCF 10GM L2	TCF 10GM L3	TCF 10GM L4
		2 Pole	3 Pole	4 Pole RSTN/NRST
Locking device	Padlock	PLD 10GM	PLD 10GM	PLD 10GM
	Mecahnical interlock	MIF 10GM 2	MIF 10GM 3	MIF 10GM R4/MIF 10GM N4
		2 Pole	3 Pole	4 Pole
Interpole barrier		TQQ 10GM 2	TQQ 10GM 3	TQQ 10GM 4
Auxiliary handle			-	

※ 1) HGM only.

Ordering Codes

HGM/HGE Type Accessory Separately

HGM/HGE50H/L, 125

Mounting

		2 Pole	3 Pole	4 Pole
Plug-in	TDM (LINE/LOAD)	-	TDM 12GM P3	-
	TDM (LINE Only)	-	TDM 12GM F3	-
	TDF (LINE Only)	-	TDF 12GM 3	-
	TDA (1 row)	-	TDA 12GM S3	-
	TDA (2 row)	-	TDA 12GM D3	-
Conn. block (CBM)		-	CBM 10GM UNIT	-
Terminal busbar (TBB)	Straight busbar	-	-	-
	Extended busbar	-	-	-
Rear terminal (RCT)		RCT 12GM F2	RCT 12GM F3	RCT 12GM F4
Cage terminal (CTB)	inch TYPE	CTB 12GM 2S	CTB 12GM 3S	CTB 12GM 4S
	mm TYPE	CTB 12GM 2S - MM	CTB 12GM 3S - MM	CTB 12GM 4S - MM
DIN rail adapter (DRA)		-	-	-

Internal Accessory

		Auxiliary Switch (AUX)	Alarm Switch (ALT)	Auxiliary/Alarm Switch (AXT)
Indication contacts		AUX 10GM C1	ALT 10GM L1	AXT 10GM L1
		AUX 10GM C2	ALT 10GM R1	AXT 10GM R1
		Shunt Trip (SHT)	Undervoltage (UVT)	
Remote tripping		SHT 10GM DC24 V	UVT 10GM DC24 V	
		SHT 10GM DC100 - 120 V	UVT 10GM DC100 - 125 V	
		SHT 10GM DC48 V	UVT 10GM DC48 V	
		SHT 10GM DC60 V	UVT 10GM AC100 - 120 V	
		SHT 10GM DC125 V	UVT 10GM AC200 - 230 V	
		SHT 10GM AC100 - 120 V	UVT 10GM AC380 - 415 V	
		SHT 10GM AC200 - 250 V	UVT 10GM AC440 - 480 V	
		SHT 10GM AC380 - 480 V	-	

External Accessory

		Front Type (TFG)	Extended Type (TFH)	
Rotary handle	Up - Line	TFG 12GM U	TFH 12GM	
	Right - Line	TFG 12GM R	TFH 12GM	
	Left - Line	TFG 12GM L	TFH 12GM	
		2 Pole	3 Pole	4 Pole
Motor operator ¹⁾		-	MOT 12GM DC24 V	
		-	MOT 12GM AC/DC110 V	
		-	MOT 12GM AC/DC240 V	
Terminal cover	Small	TCF 12GM S2	TCF 12GM S3	TCF 12GM S4
	Large	TCF 12GM L2	TCF 12GM L3	TCF 12GM L4
Locking device	Padlock	PLD 10GM	PLD 10GM	PLD 10GM
	Mecahnical interlock	MIF 12GM 2	MIF 12GM 3	MIF 12GM R4/MIF 12GM N4
Interpole barrier		TQQ 10GM 2	TQQ 10GM 3	TQQ 10GM 4
Auxiliary handle			-	

※ ¹⁾ HGM only.

HGM/HGE160, 250

Mounting

		2 Pole	3 Pole	4 Pole
Plug-in	TDM (LINE/LOAD)	-	TDM 25GM P3	-
	TDM (LINE Only)	-	TDM 25GM F3	-
	TDF (LINE Only)	-	-	-
	TDA (1 row)	-	-	-
	TDA (2 row)	-	-	-
Conn. block (CBM)		-	CBM 10GM UNIT	-
Terminal busbar (TBB)	Straight busbar	TBB 25GP 2S	TBB 25GP 3S	TBB 25GP 4S
	Extended busbar	-	TBB 25GP 3E4S	TBB 25GP 4E4S
Rear terminal (RCT)	Line	RCT 25GM F2 LINE	RCT 25GM F3 LINE	RCT 25GM F4 LINE
	Load	RCT 25GM F2 LOAD	RCT 25GM F3 LOAD	RCT 25GM F4 LOAD
Cage terminal (CTB)	inch TYPE	CTB 25GM 2S	CTB 25GM 3S	CTB 25GM 4S
	mm TYPE	CTB 25GM 2S - MM	CTB 25GM 3S - MM	CTB 25GM 4S - MM
DIN rail adapter (DRA)		-	-	-

Internal Accessory

		Auxiliary Switch (AUX)	Alarm Switch (ALT)	Auxiliary/Alarm Switch (AXT)
Indication contacts		AUX 10GM C1	ALT 10GM L1	AXT 10GM L1
		AUX 10GM C2	ALT 10GM R1	AXT 10GM R1
		Shunt Trip (SHT)	Undervoltage (UVT)	
Remote tripping		SHT 10GM DC24 V	UVT 10GM DC24 V	
		SHT 10GM DC100 - 120 V	UVT 10GM DC100 - 125 V	
		SHT 10GM DC48 V	UVT 10GM DC48 V	
		SHT 10GM DC60 V	UVT 10GM AC100 - 120 V	
		SHT 10GM DC125 V	UVT 10GM AC200 - 230 V	
		SHT 10GM AC100 - 120 V	UVT 10GM AC380 - 415 V	
		SHT 10GM AC200 - 250 V	UVT 10GM AC440 - 480 V	
		SHT 10GM AC380 - 480 V	-	

External Accessory

		Front Type (TFG)	Extended Type (TFH)	
Rotary handle	Up - Line	TFG 25GM U	TFH 25GM	
	Right - Line	TFG 25GM R	TFH 25GM	
	Left - Line	TFG 25GM L	TFH 25GM	
		2 Pole	3 Pole	4 Pole
Motor operator ¹⁾		-	MOT 25GM DC24 V	
		-	MOT 25GM AC/DC110 V	
		-	MOT 25GM AC/DC240 V	
Terminal cover	Small	TCF 25GM S3		TCF 25GM S4
	Large	TCF 25GM L3		TCF 25GM L4
		2 Pole	3 Pole	4 Pole RSTN/NRST
Locking device	Padlock	PLD 10GM	PLD 10GM	PLD 10GM
	Mecahnical interlock	MIF 25GM 3		MIF 25GM R4/MIF 25GM N4
		2 Pole	3 Pole	4 Pole
Interpole barrier		TQQ 25GM 2	TQQ 25GM 3	TQQ 25GM 4
Auxiliary handle		-		

※ 1) HGM only.

Ordering Codes

HGM/HGE Type Accessory Separately

HGM/HGE400

Mounting

		2 Pole	3 Pole	4 Pole
Plug-in	TDM (LINE/LOAD)	-	TDM 40GM P3	-
	TDM (LINE Only)	-	TDM 40GM F3	-
Conn. block (CBM)		-	CBM 10GM UNIT	-
Terminal busbar (TBB)	Straight busbar	TBB 40GM 2S	TBB 40GM 3S	TBB 40GM 4S
	Extended busbar	-	TBB 40GM 3E59	TBB 40GM 4E59
Rear terminal (RCT)	Line	-	RCT 40GM F3 LINE	RCT 40GM F4 LINE
	Load	-	RCT 40GM F3 LOAD	RCT 40GM F4 LOAD
Cage terminal (CTB)	1 Hole	-	CTB 40GM 3S1H	CTB 40GM 4S1H
	2 Hole	-	CTB 40GM 3S	CTB 40GM 4S

Internal Accessory

		Auxiliary Switch (AUX)	Alarm Switch (ALT)
Indication contacts		AUX 40GM C1	ALT 40GM L1
		Shunt Trip (SHT)	Undervoltage (UVT)
Remote tripping		SHT 40GM DC24 V	UVT 40GM DC24 V
		SHT 40GM DC100 - 125 V	UVT 40GM DC110 - 125 V
		SHT 40GM AC100 - 120 V	UVT 40GM AC100 - 125 V
		SHT 40GM AC200 - 230 V	UVT 40GM AC220 - 230 V
		SHT 40GM AC380 - 415 V	UVT 40GM AC380 - 415 V
		SHT 40GM AC440 - 480 V	UVT 40GM AC440 - 480 V

External Accessory

		Front Type (TFG)	Extended Type (TFH)	
Rotary handle	Up - Line	TFG 40GM U	TFH 40GM	
	Right - Line	TFG 40GM R	TFH 40GM	
	Left - Line	TFG 40GM L	TFH 40GM	
		2 Pole	3 Pole	4 Pole
Motor operator ¹⁾		-	MOT 40GM DC24 V	
		-	MOT 40GM AC/DC110 V	
		-	MOT 40GM AC/DC240 V	
Terminal cover	Small	TCF 40GM S3		TCF 40GM S4
	Large	TCF 40GM L3		TCF 40GM L4
Locking device	Padlock	PLD 40GM	PLD 40GM	PLD 40GM
	Mecahnical interlock	MIF 40GM 3		MIF 40GM R4/MIF 40GM N4
Interpole barrier		-	TQQ 63GP 3	TQQ 63GP 4
Auxiliary handle		THA 48GM		

※ ¹⁾ HGM only.

HGM/HGE630, 800

Mounting

		2 Pole	3 Pole	4 Pole
Plug-in	TDM (LINE/LOAD)	-	TDM 80GM P3	-
	TDM (LINE Only)	-	TDM 80GP F3	-
Conn. block (CBM)		-	CBM 10GM UNIT	-
Terminal busbar (TBB)	Straight busbar	TBB 63GM 2S (HGM/HGE630) TBB 80GM 2S (HGM/HGE800)	TBB 63GM 3S (HGM/HGE630) TBB 80GM 3S (HGM/HGE800)	TBB 63GM 4S (HGM/HGE630) TBB 80GM 4S (HGM/HGE800)
	Extended busbar	-	-	-
Rear terminal (RCT)	Line	-	RCT 80GM F3 LINE	RCT 80GM F4 LINE
	Load	-	RCT 80GM F3 LOAD	RCT 80GM F4 LOAD
DIN rail adapter (DRA)		-	CTB 80GM 3S	CTB 80GM 4S

Internal Accessory

	Auxiliary Switch (AUX)	Alarm Switch (ALT)
Indication contacts	AUX 40GM C1	ALT 40GM L1
	Shunt Trip (SHT)	Undervoltage (UVT)
Remote tripping	SHT 40GM DC24V	UVT 40GM DC24 V
	SHT 40GM DC100 - 125 V	UVT 40GM DC110 - 125 V
	SHT 40GM AC100 - 120 V	UVT 40GM AC100 - 125 V
	SHT 40GM AC200 - 230 V	UVT 40GM AC220 - 230 V
	SHT 40GM AC380 - 415 V	UVT 40GM AC380 - 415 V
	SHT 40GM AC440 - 480 V	UVT 40GM AC440 - 480 V

External Accessory

		Front Type (TFG)	Extended Type (TFH)
Rotary handle	Up - Line	TFG 80GM U	TFH 80GM
	Right - Line	TFG 80GM R	TFH 80GM
	Left - Line	TFG 80GM L	TFH 80GM
		3 Pole	4 Pole
Motor operator ¹⁾		-	MOT 80GM DC24 V
		-	MOT 80GM AC/DC110 V
		-	MOT 80GM AC/DC240 V
Terminal cover	Small	TCF 80GM S3	
	Large	TCF 80GM L3	
Locking device	Padlock	PLD 40GM	PLD 40GM
	Mecahnical interlock	MIF 800GM 3	
Interpole barrier		-	TQQ 63GP 3
Auxiliary handle		THA 48GM	
			TCF 80GM S4
			TCF 80GM L4
			PLD 40GM
			MIF 80GM R4/MIF 80GM N4
			TQQ 63GP 4

※ ¹⁾ HGM only.

Maintenance & Certifications

Service Environment

- 159 Storage & Transportation
- 160 Installations
- 164 Maintenance

Certifications

- 165 Molded Case Circuit Breakers (MCCB)
- 167 Earth Leakage Circuit Breakers (ELCB)

Service Environment

Storage & Transportation

Storage Precaution



- Do not store in an environment containing corrosive gases (ammonia, sulfur etc)



- Do not store under high humidity



- Do not store under direct sunlight



- Do not store in an environment in which dust or dirt is present

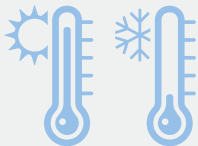

- Avoid using this product under extremely high or low temperature and store at a temperature between -20°C and $+60^{\circ}\text{C}$

Transportation Precaution

Precaution

- Do not drop or give shock during transportation. These can cause malfunctions in the circuit breakers.
- Do not carry circuit breakers by the external wire or accessories.



- Always hold the body of the circuit breakers during transportation



- Be careful of injuries when handling sharp metal accessories



- Do not drop or give shock during transportation



- Check the packaging condition before transportation

Service Environment

Installations

For dimensions required for installation, please refer to the catalog.

▲ Precaution

- Installations must be carried out by licensed worker.
- Check whether the circuit breaker is open before performing any wiring.
- Tighten the terminal bolt using the proper torque as specified in the manual when connecting the bus or wire. Loose connections may result in.
- Tighten the terminal bolt as proper torque specified in manual or catalog. If not insulated, it may cause short-circuit fault.

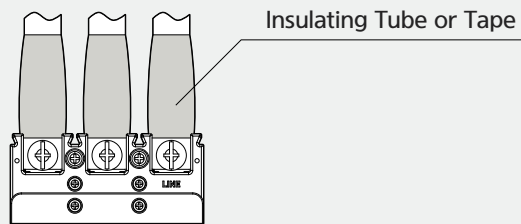
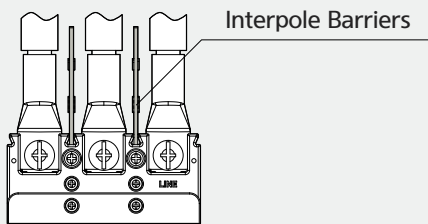

- Provide enough insulating space to avoid the blockage of arc gas. Blocked arc gas vent may cause trip operation to fail.
- Do not install in an environment where hot and humid air, dust, corrosive gas, vibration and shock is present. This may cause a fire or malfunction.
- To prevent fires or malfunctions, provide appropriate measures to prevent the entry of foreign substances following installation.
- For the 4P circuit breakers, connect 3 wires and 4 poles to the neutral line.
- This product should be used with insulation barrier. Using with no insulation barrier may result in additional short-circuit fault.

Precautions for Installations

- **Install circuit breakers under the following environment conditions**

When installing circuit breakers, give due consideration to the environment conditions described below. Installation in inappropriate conditions may result in malfunction or fire.

- Ambient temperature: $-5\text{ }^{\circ}\text{C}$ - $+40\text{ }^{\circ}\text{C}$
(The average temperature for 24 hours not exceed $35\text{ }^{\circ}\text{C}$)
- Relative humidity: 45 - 85 %
- Vibration & Shock: Without excessive vibration and shock
- Altitude: Up to 2,000 m
- Without excessive water vapor, oil vapor, smoke, dust, salts and corrosive materials



- **Do not block the arc vent**
The breaking capacity may be reduced.



- **Keep away from dust, metal shaving**
After installations, please use protective cover when maintaining circuit.



- **Do not release insulation board from circuit breakers.**
The insulation performance may be reduced.

Precautions for Connection



- **Tighten the terminal bolts with proper torque specified in the manual**
Incomplete tightening of the terminal bolt may cause overheating. Also, excessive tightening of torque may cause damage to the terminal bolt and circuit breaker case.



- **Avoid using lube in terminal bolt**
Lube may reduce friction of terminal bolt.



- **Insulate the exposed conductor**
Insulate the MCCB conductor by using insulation tape. If the conductor is not be insulated, it may cause additional short-circuit fault.

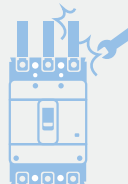

- **Please do not modify STUD**
Rear connection type, do not force STUD. Also, when connecting wire, access without modifying STUD.



- **For 4P circuit breakers, connect 3 wires and 4 poles to the neutral line**



- **Please fasten conductor firmly in parallel**
Firmly fasten conductor to prevent electronic repulsion when a short-circuit fault occur.

Service Environment

Installations

Connections to the Power Circuit

The shock electromagnetic force caused by fault current is as follows.

The Shock Electromagnetic Force Per 1 m Conductor

Short Circuit Current [kA] (Power factor)	Shock Electromagnetic Force (3 phase)	
	Distance Between Conductors 10 cm	Distance Between Conductors 20 cm
10 (0.4)	490 (50)	245 (25)
18 (0.3)	1,863 (190)	932 (95)
25 (0.2)	4,412 (450)	2,206 (225)
35 (0.23)	8,630 (880)	4,315 (440)
42 (0.2)	12,455 (1,270)	6,277 (635)
50 (0.2)	17,652 (1,800)	8,826 (900)
65 (0.2)	29,910 (3,050)	14,955 (1,525)
85 (0.2)	51,190 (5,220)	25,595 (2,510)
100 (0.2)	70,804 (7,220)	35,402 (3,610)
125 (0.2)	110,815 (11,300)	55,408 (5,650)

- Before installation, be sure to clean on connection terminals

To prevent to increasing contact resistance, eliminate any dust, dirt or damages of any kind.

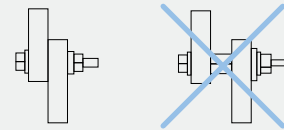

- Conductor should be connected directly

Bolts or Nuts is not allowed between conductors.

If the conductors are not connected directly, it may result in rising temperatures and fires.

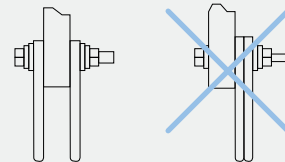

- Conductors should be connected without overlap

When connecting several conductors, the busbar should be installed on both sides.

Inspection and Maintenance

Initial Inspection

- Terminal parts shall be clean from dust, metal pieces and so on
- Breaker shall not have any crack or damage
- Check terminal parts. It should be tightened with specified torque
- Be sure to check the value of U_e , I_{cu} of the breakers
- Insulance resistance should be more than $5 M\Omega$

Dielectric Test

Main Circuit		Secondary and Control Circuit ¹⁾	
Rated Insulation Voltage [Ui]	Test Voltage	Rated Insulation Voltage [Ui]	Test Voltage
$U_i \leq 300 V$	2,000 V for 1 min	$U_{is} \leq 60 V$	1,000 V for 1 min
$300 < U_i \leq 600 V$	2,500 V for 1 min	$60 V < U_{is} \leq 600 V$	$2 \cdot U_{is}$ 1,000 V (Minimum 1,500 V) for 1 min

※ - Dielectric strength tests should be done in these conditions.

1) Between terminals and earth

Periodic Inspection

In order to maintain the breaker performance and prevent accidents, periodical inspection shall be conducted after installation and operation.

Standard of Inspection

Standard	Circumstance	Inspection Cycle after Installation
Normal	Clean air, no humidity	Within 10 years: Once 2 - 3 year
		More than 10 years: Once a year
		More than 15 years: Once 6 month
	Dust but no corrosive gas	Within 10 years: Once 1 year
		More than 10 years: Once 6 month
		More than 15 years: Once a year
Bad	Sulfurous gas, salinity, vapor	Within 5 years: Once 6 month
		More than 5 years: Once a year
	Excessive corrosive gas	Once a month

Periodic Check Point

Item of Inspection	Procedure	Trouble Shooting
Tightening terminal torque	• Tightening torque on terminals	• Applying the tightening torque indicated in manual Too strong tightening torque may cause damage
Dust and dirt	• Confirm to breaker's body and upper side of the line part. Be sure to clean in term of dust and dirt to secure insulation	• Remove the debris with a clean tool
Case	• Check for damaged and cracked on breakers	• Replace with a new breaker
Arc exhaust part	• Check terminal part for arc exhaust.	• Replace with a new breaker in case you can find the black soot and melted metal parts on the breakers
Operation	• Manually put On and OFF several times in case of holding close position. • It makes reduce friction which is made from harden grease and stabilize contact resistance	• Replace with a new breaker in case of malfunction on ON and OFF • Replace with a new breaker in case of exceeding mechanical and electrical durability
Terminal discoloration	• Check for discolored terminal and conductor parts • Be sure to confirm insulation capability on conductor parts	• There in no problem with lightly discolored silver coating part. In case breakers have an insulation trouble caused by heat, replace with a new breaker
Insulation resistance	• Measure insulation resistance between each poles, terminal and earth	• Insulation resistance should be more than 5 M Ω . If lower than 5 M Ω , replace with new one

Inspection and Trouble Shooting After Breaking Current

- If there is no pollution in arc exhaust parts and no other abnormality, the breaker can be re-used.
- Measure the insulation resistance when carbonizing symptom is found around arc exhaust parts. If the resistance value is more than 5M Ω with no dielectric breakdown at withstand test voltage and no excessive temperature rise of terminal parts, the breaker can be re-used.
- If the handle part is carbonized or there is metallic melting in internal of breaker, please replace it with a new one.

Service Environment

Maintenance

Trouble Shooting





In case of any abnormality during breaker operation, please refer it as below. The following table lists a series of typical service conditions, to help you understand and solve hypothetical faults or malfunctions.

Problem	Symptom	Possible Cause	Trouble Shooting	
Overheating	High temperature of terminal part	• Loose connection between terminal and conductor	Mounting screw with proper torque	
		• Increased resistance between terminal and conductor	Replace with a new breaker	
	Damage in insulation part of terminal	• Loose connection between terminal and conductor • Loose connection on terminal parts caused by interference with foreign substance	Replace with a new breaker	
Overheating	High temperature of breaker body	• Increased contact resistance	Replace with a new breaker	
		• Loose internal assembly screws		
		• Increase of current density from cable disconnection		
Overheating	Abnormal voltage of load side	• Excessive contact abrasion	Replace with a new breaker	
		• Foreign substances on contact		
		• Melt down on conducting bar (Corrosion of conductor by excessive ON-OFF or corrosive gas)		
Inability of ON, OFF, and RESET	Inability of ON	• Inability of reset after trip	On after RESET	
		• Damaged trip mechanical parts due to lots of operation and improper frequency	Replace with a new breaker	
		• Non-energized UVT	Input operational control voltage	
	Inability of OFF	• Melted and adhered contact tip	Replace with a new breaker	
		Inability of RESET	• Non-energized UVT	Input operational control voltage
	• Not enough cooling on bi-metal		Cool down ambient temperature, then Reset	
	• Corruption and deformation of bi-metal		Replace with a new breaker	
	• Malfunction of mechanical parts			
	• Run out of excessive ON-OFF			
	• Damaged mechanical parts after trip on over-breaking capacity			
Frequent trip	Trip at under rated current	• High ambient temperature (Higher than 40)	Cool down ambient temperature by ventilation or others	
		• Heating by loose terminal screw connection	Tighten screws with specified torque	
		• Heating from inside of breaker	Replace with a new breaker	
		• Connection conductor of which cross-section area is smaller than specified size	Use the specified size of conductor or adjust the rated current	
	Trip at operational current	• Trip at start-up inrush current	Adjust the instantaneous trip setting or replace with a higher rated current breaker	
		• Trip at change-over in star-delta operation		
		• Instantaneous trip at reverse feeding	Replace with a higher rated current breaker	
		• Instantaneous trip at high inrush current		
• Instantaneous trip at long starting current	Repair or replace with new motors and check wiring cables			
• Short-circuit due to motor malfunction				
• Fault of connecting with SHU or UVT				
Non trip	Non trip at the current higher than specified	• Low coordination with primary protect device or miss-selected with other protect device	Reconsider of coordination	
		• Unconsidered ambient temperature	Confirm the derating current	
		• Improper rated current	Confirm rated current	
Malfunction of Accessory	Malfunction of SHT	• Over and under control voltage	Confirm rated voltage	
		• Drop of the control voltage	Keep control	
		• Incorrect coil voltage, damaged coil caused by non operating of switch in order to prevent malfunctioning	Replace with new parts	
	Malfunction of UVT	• Malfunction of mechanism part	Replace with new parts	
		• Incorrect coil voltage	Confirm control voltage	
		• Burned UVT controller of the coil	Replace or check for wiring	
	Malfunction of AUX and ALT	Malfunction of AUX and ALT	• Damaged contact caused by excessive rated operational current	Replace or check for operational current
			• Malfunction of mechanism part	Replace or repair

Certifications

Molded Case Circuit Breakers (MCCB)









Certifications

Type		Approvals			CB Certificates
Certificate		Safety Certi	KS	IEC (CE)	DEKRA
Mark					
Country		KOREA	KOREA	EUROPE	NETHERLANDS
HGM30	E	•	•	•	•
	S	•	•	•	•
HGM50	E	•	•	•	•
	S	•	•	•	•
	H	•	•	•	•
	L	•	•	•	•
HGM60	E	•	•	•	•
	S	•	•	•	•
	H	•	•	•	•
	L	•	•	•	•
HGM100	E	•	•	•	•
	S	•	•	•	•
	H	•	•	•	•
	L	•	•	•	•
HGM125	E	•	•	•	•
	S	•	•	•	•
	H	•	•	•	•
	L	•	•	•	•
HGM160	E	•	•	•	•
	S	•	•	•	•
	H	•	•	•	•
	L	•	•	•	•
HGM250	E	•	•	•	•
	S	•	•	•	•
	H	•	•	•	•
	L	•	•	•	•
HGM400	E	•	•	•	•
	S	•	•	•	•
	H	•	•	•	•
	L	•	•	•	•
HGM630	E	•	•	•	•
	S	•	•	•	•
	H	•	•	•	•
	L	•	•	•	•
HGM800	S	•	•	•	•
	H	•	•	•	•
	L	•	•	•	•

Certifications





Molded Case Circuit Breakers (MCCB)

Marine Certifications

Type		Approvals							
Certificate		KR	LR	BV	ABS	DNV·GL	RS	RINA	ClassNK
Mark									
National Certification		KOREA	U.K	FRANCE	U.S.A	GERMANY	RUSSIA	ITALY	JAPAN
HGM30	E	●	●	●	●	●	●	●	●
	S	●	●	●	●	●	●	●	●
HGM50	E	●	●	●	●	●	●	●	●
	S	●	●	●	●	●	●	●	●
	H	●	●	●	●	●	●	●	●
	L	●	●	●	●	●	●	●	●
HGM60	E	●	●	●	●	●	●	●	●
	S	●	●	●	●	●	●	●	●
	H	●	●	●	●	●	●	●	●
	L	●	●	●	●	●	●	●	●
HGM100	E	●	●	●	●	●	●	●	●
	S	●	●	●	●	●	●	●	●
	H	●	●	●	●	●	●	●	●
	L	●	●	●	●	●	●	●	●
HGM125	E	●	●	●	●	●	●	●	●
	S	●	●	●	●	●	●	●	●
	H	●	●	●	●	●	●	●	●
	L	●	●	●	●	●	●	●	●
HGM160	E	●	●	●	●	●	●	●	●
	S	●	●	●	●	●	●	●	●
	H	●	●	●	●	●	●	●	●
	L	●	●	●	●	●	●	●	●
HGM250	E	●	●	●	●	●	●	●	●
	S	●	●	●	●	●	●	●	●
	H	●	●	●	●	●	●	●	●
	L	●	●	●	●	●	●	●	●
HGM400	E	●	●	●	●	●	●	●	●
	S	●	●	●	●	●	●	●	●
	H	●	●	●	●	●	●	●	●
	L	●	●	●	●	●	●	●	●
HGM630	E	●	●	●	●	●	●	●	●
	S	●	●	●	●	●	●	●	●
	H	●	●	●	●	●	●	●	●
	L	●	●	●	●	●	●	●	●
HGM800	S	●	●	●	●	●	●	●	●
	H	●	●	●	●	●	●	●	●
	L	●	●	●	●	●	●	●	●

Earth Leakage Circuit Breakers (ELCB)

Certifications

Type	Approvals			CB Certificates
Certificate	Safety Certi	KS	IEC (CE)	DEKRA
Mark				
Country	KOREA	KOREA	EUROPE	NETHERLANDS
HGE30	E	•	•	•
	S	•	•	•
HGE50	E	•	•	•
	S	•	•	•
	H	•	•	•
	L	•	•	•
HGE60	E	•	•	•
	S	•	•	•
	H	•	•	•
	L	•	•	•
HGE100	E	•	•	•
	S	•	•	•
	H	•	•	•
	L	•	•	•
HGE125	E	•	•	•
	S	•	•	•
	H	•	•	•
	L	•	•	•
HGE160	E	•	•	•
	S	•	•	•
	H	•	•	•
	L	•	•	•
HGE250	E	•	•	•
	S	•	•	•
	H	•	•	•
	L	•	•	•
HGE400	E	•	•	•
	S	•	•	•
	H	•	•	•
	L	•	•	•
HGE630	E	•	•	•
	S	•	•	•
	H	•	•	•
	L	•	•	•
HGE800	S	•	•	•
	H	•	•	•
	L	•	•	•



KOREA

Headquarter (Financial)	Hyundai Bldg, 75, Yulgok-ro, Jongno-gu, Seoul, Korea Tel: +82-2-746-7646 / Fax: +82-2-746-7441
Sales & Marketing (Seongnam)	5th Floor 55, Bundang-ro, Bundang-gu, Seongnam-si, Gyeonggi-do, Korea Tel: +82-31-8006-6780 / Fax: +82-31-8006-6898
Main Factory (Ulsan)	700, Bangeojisunhwan-doro, Dong-gu, Ulsan, Korea Tel: +82-52-202-8114 / Fax: +82-52-202-8010
Seonam Factory (Ulsan)	223, Sapyong-ro, Nam-gu, Ulsan, Korea Tel: +82-52-202-8114
R&D Center (Yongin)	17-10, 240-gil, Mabuk-ro, Giheung-gu, Yongin-si, Korea Tel: +82-31-289-5114 / Fax: +82-31-289-5040

OVERSEAS

Branch Offices

U.S.A (Atlanta)	6100 Atlantic Boulevard, 2nd FL., Norcross, GA30071, U.S.A Tel: +1-678-823-7839 / Fax: +1-678-823-7553
Japan (Osaka)	5th Floor Nagahori Plaza Bldg. 2-4-8 Minami Senba, Chuo-ku, Osaka 542-0081, Japan Tel: +81-6-6261-5766~7 / Fax: +81-6-6261-5818
Saudi Arabia (Riyadh)	Office number 404, 4th floor, Akaria-3 building, Olaya street, P.O Box 8072, Riyadh, 11482, Kindom of Saudi Arabia Tel: +966-11-464-4696, 9366 / Fax: +966-11-462-2352
Russia (Moscow)	World Trade Center, Ent.3, #703, Krasnopresnenskaya Nab.12, Moscow, 123610, Russia Tel: +7-495-258-1381
U.A.E (Dubai)	Unit 205, Emaar Square Building No.4 Sheikh Zayed Road, Dubai 252458, U.A.E Tel: +971-4-425-7995 / Fax: +971-4-425-7996
Germany (Frankfurt)	Mendelssohn strabe 55-59 Frankfurt 60325, Germany Tel: +49-69-4699-4988
Thailand (Bangkok)	19th Floor, Unit 1908, Sathorn Square Office Tower, 98 North Sathorn Road, Silom, Bangrak, Bangkok 10500, Thailand Tel: +66-02-115-7920 / Fax: +66-2-115-7898

Subsidiaries

U.S.A (Alabama)	Inc., 215 Folmar Parkway, Montgomery, AL 36105, U.S.A. Tel: +1-334-481-2000 / Fax: +1-334-481-2098
Bulgaria (Sofia)	41, Rojen Blvd., 1271 Sofia, Bulgaria Tel: +359-2-803-3200, 3210, 3220 / Fax: +359-2-803-3203, 3242
China (Yangzhong)	No.9, Xiandai Road, Xinba Scientific and Technologic Zone, Yangzhong, Jiangsu, P.R.C. Zip:212212, China Tel: +86-511-8842-0666, 0500 / Fax: +86-511-8842-0668, 0231
India (Anantapur)	5-289-4, Near Aimuktheeshwara Temple, Penukonda Mandal, Penukonda, Anantapur Dist, Andhrapradesh-515110, India Tel: +91-93982-5137

R&D Centers

Hungary (Budapest)	Hyundai Technologies Center Hungary Ltd., 1146, Budapest, Hermina ut 22, Hungary Tel: +36-1-273-3733 / Fax: +36-1-220-6708
China (Shanghai)	Room 10102, Building 10, No.498, Guoshoujing Road, Pudong, Shanghai, China Tel: +86-21-5013-3393 #108 / Fax: +86-21-5013-3393 #105
Switzerland (Zurich)	Hardturmstrasse 135, CH-8005, Zurich, Switzerland Tel: +41-44-527-0-56