

# Motor Condition Monitoring Devices

K6CM series

## Stay alert to motor failures with 24/7 motor condition monitoring

### Load abnormality

**CI** Comprehensive current diagnosis [Ver.UP]

### Bearing wear

**VB** Vibration & temperature monitoring

### Insulation degradation

**IS** Insulation resistance monitoring

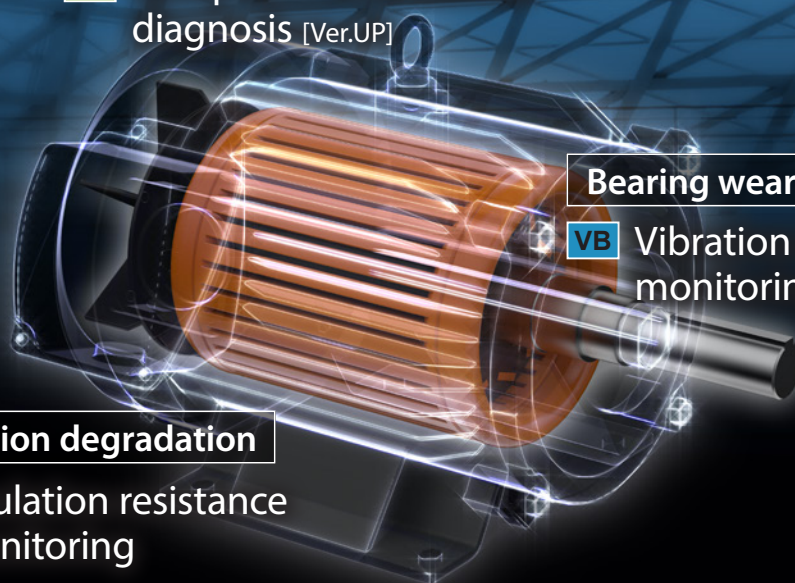

- Applicable in environment with inverters
- Prioritize maintenance inspections
- Configuration tool for fast rollout
- Clamp-type CT which is easy to install on existing equipment



EtherNet/IP<sup>®</sup>  
Modbus



Reduce the amount of required manual inspections

# K6CM informs you when your motor requires

## [Problems]

### It's difficult to prevent motor issues caused by degradation.

The conventional motor condition check had several check items. Therefore a skilled maintenance engineer was required to judge the motor's maintenance timing. Additionally, inspection was time-consuming because there were many motors.

#### Example of patrol inspection items

Phenomenon Symptoms	Vibration	Heat generation	Decreased electrical resistance	Overcurrent
Bearing wear	✓	✓		✓
Insulation degradation			✓	
Overload	✓	✓		✓
Open phase		✓		

#### Motor failure mode

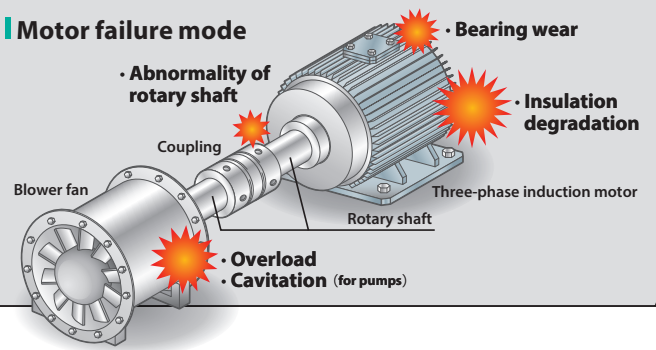

### Monitors the 3-phase induction motor which is critical to facility operations

Ventilation fans in odorous gas treatment facilities

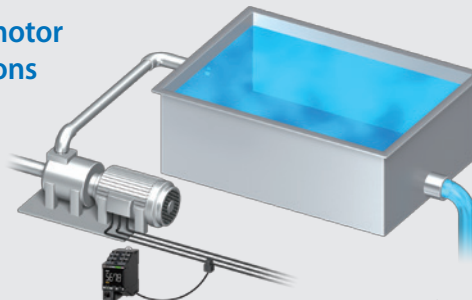
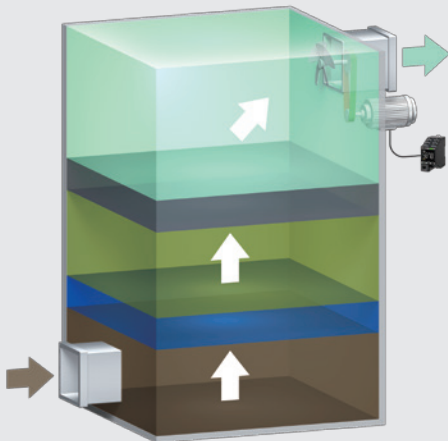

Washing pumps for automotive components

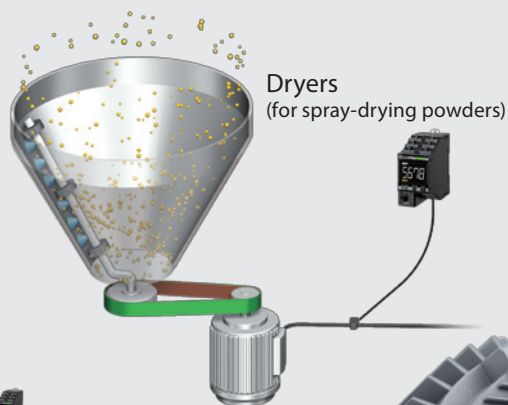

Dryers (for spray-drying powders)

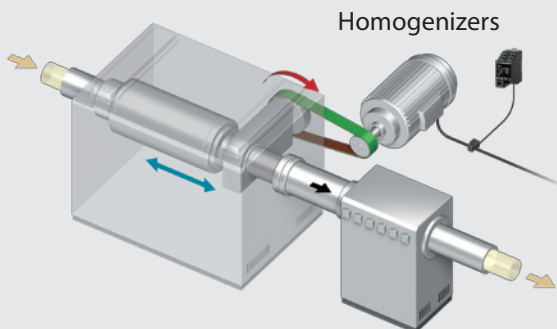

Homogenizers

Notify the factory floor with stack light



# maintenance

[Solution from OMRON]

## Motors can be maintained in advance of failure due to degradation.

K6CM(comprehensive current diagnosis type) can consistently monitor the degradation tendency of the motor by observing the current waveform of the motor and processing complex analysis such as the frequency analysis, instead of a skilled maintenance engineer. Additionally, you can understand the motor's maintenance timing without depending on an engineer, because K6CM provides threshold value setting.

### What is comprehensive current diagnosis?

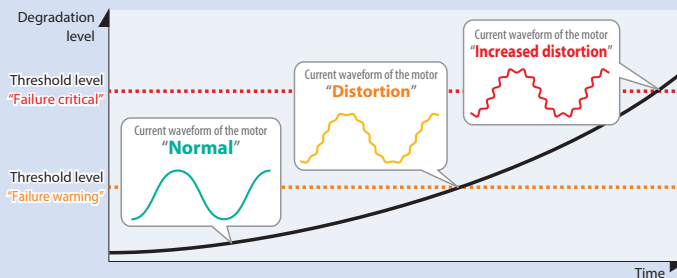

When an abnormality occurs in the load such as bearing, rotary shaft, or reducer, the motor does not rotate smoothly and a distortion occurs in its current waveform. K6CM measures its distortion as a degradation level.



### Monitor up to 10 motors with PC software

With the accessory software "Motor Condition Monitoring Tool", you can monitor motor conditions remotely.

\* The screen is a sample image.



K6CM Motor Condition Monitoring Devices

- ◆ Development Award of the TPM Award for Excellent Products 2018
- ◆ GOOD DESIGN AWARD 2018



EtherNet/IP™  
Modbus

# Motor Condition Monitoring Device Lineup

Note. Applicable motor type: three-phase induction motor

**type 01** Comprehensively monitors motor and load abnormalities through degradation level

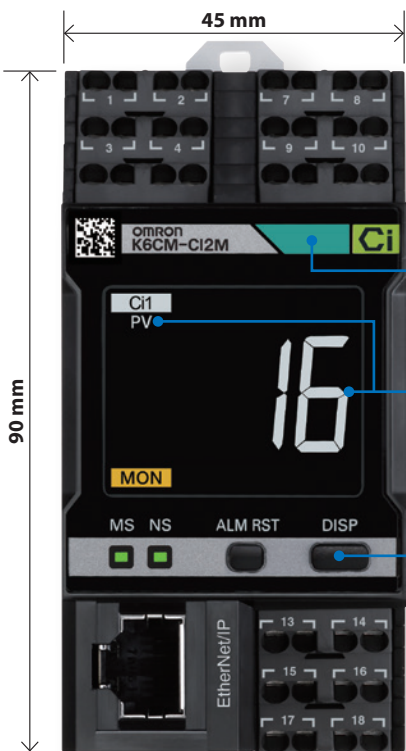

## K6CM-CI



**Comprehensive current diagnosis type**

### Alarm bar display

- Green : Status normal
- Yellow : Failure warning
- Red : Failure critical

### Display

- [PV] : Present value
- [MIN] : Minimum value
- [MAX] : Maximum value

### Switches the units of the measured value displayed

- [Ci1] : Degradation level 1
- [Ci2] : Degradation level 2
- [A] : Current

<Actual size>

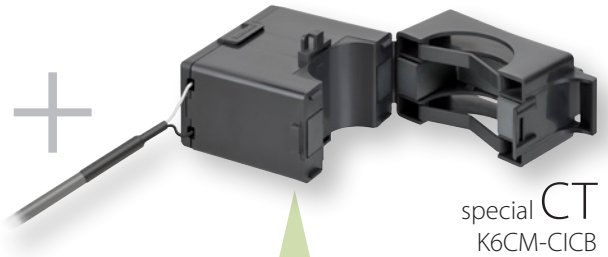

### Easy setup!

To perform monitoring, simply clamp the CT to the power line connected to the three-phase induction motor. The maximum of measurement range of 600A.



### Also detects load abnormalities

When a load abnormality occurs, the current waveform of the motor changes, which allows the load abnormality to be detected.

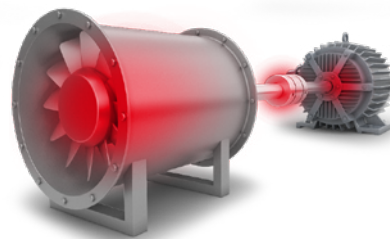

### Multiply to monitor the abnormalities by measuring degradation level 1 and degradation level 2, that are measured with different algorithms

#### Degradation level 1

Degradation level 1 is suited to monitoring abnormalities that have an irregular affect on the shaft of the motor because it can quantify the degree of deviation between the smooth sine wave of the ideal state and the entire current waveform as obtained during the sampling period.

#### [Abnormality detection]

Cavitation, Air contamination, etc.

#### Degradation level 2

Degradation level 2 is suited to monitoring abnormalities which occurs periodically because certain frequency components among the frequency components affecting the rotating shaft of the motor are clearly captured and quantified. Even in environment with inverter noise, a motor or load abnormality can be captured with excellent sensitivity.

#### [Abnormality detection]

Misalignment, Load imbalance, Foreign matter adhesion, etc.

Comprehensive current diagnosis parameters are applicable for a wide range of motor abnormalities.

**Normal state when inverters are used**

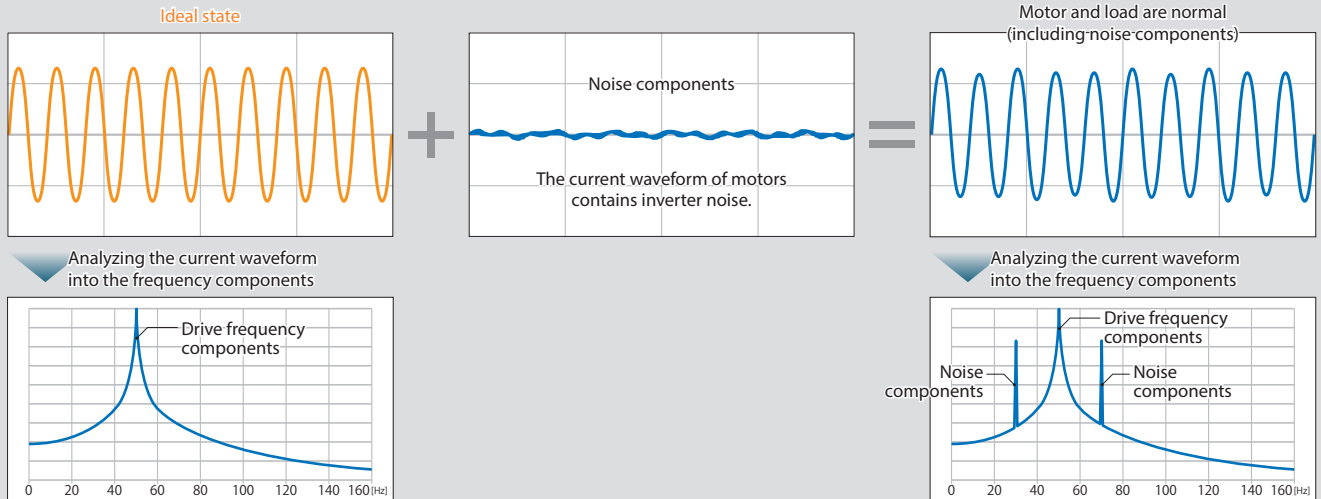

**Irregular change Degradation level 1**

In the case of the abnormality with higher sensitivity of degradation level 1.

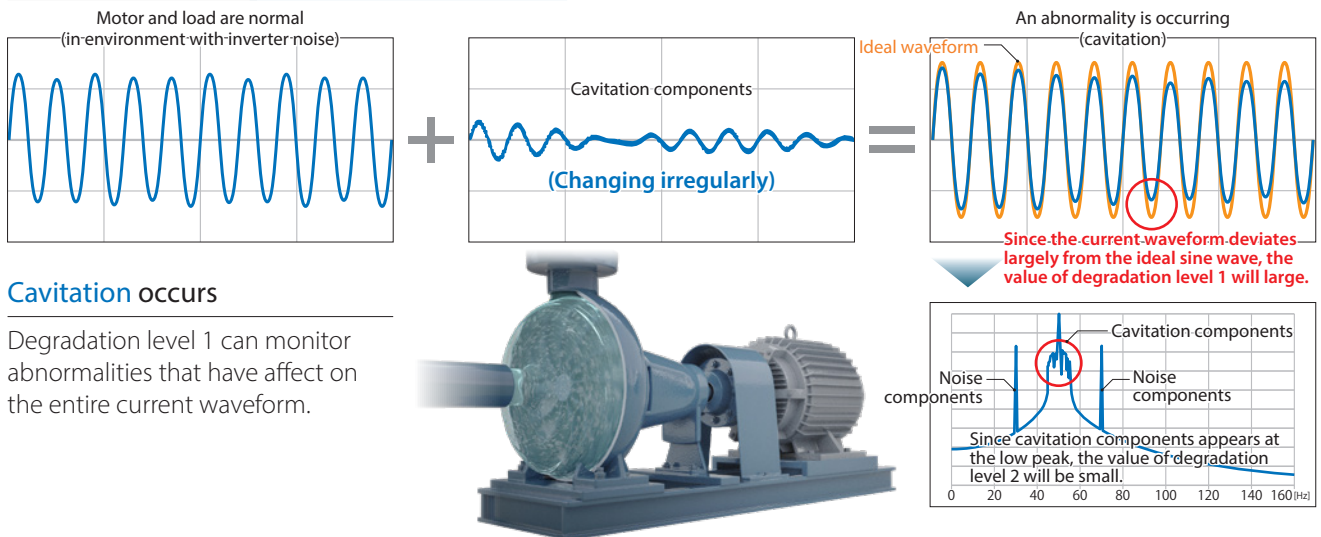

**Periodic change Degradation level 2**

In the case of the abnormality with higher sensitivity of degradation level 2.

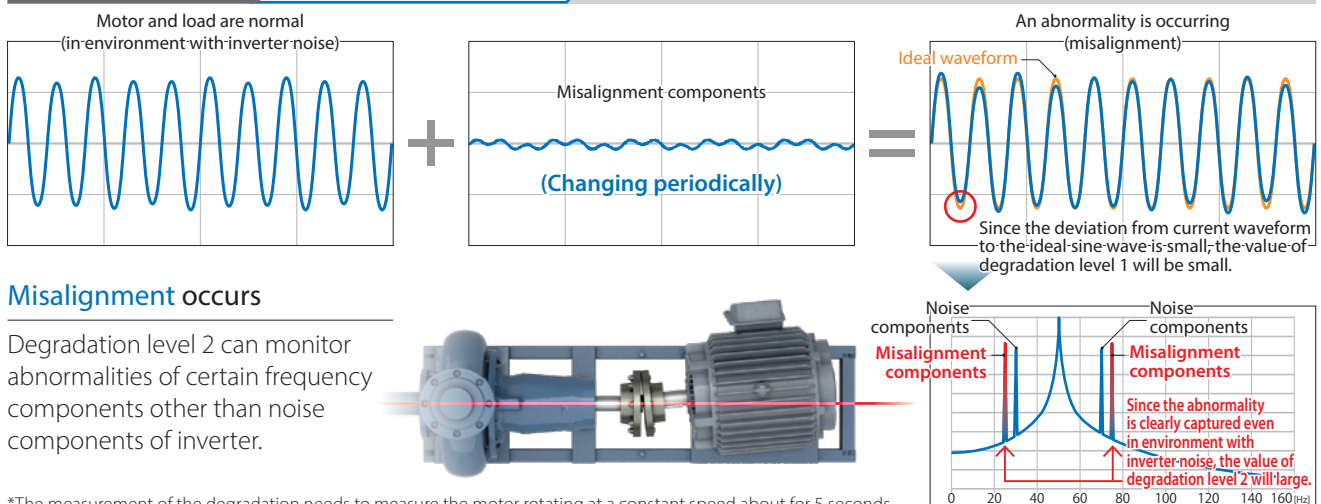

\*The measurement of the degradation needs to measure the motor rotating at a constant speed about for 5 seconds.

# Motor Condition Monitoring Device Lineup

Note. Applicable motor type: three-phase induction motor

type 02 Monitors bearing abnormalities through vibration and temperature



## K6CM-VB



Vibration & temperature monitoring type

### Detects abnormalities in bearings

By constantly monitoring for vibrations, it can detect signs of abnormalities in bearings and the like as soon as possible.





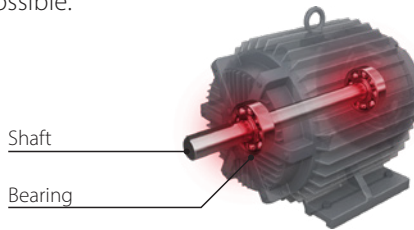

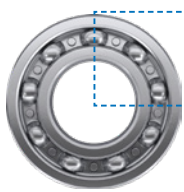

### Constantly monitors temperature

The surface temperature of the routinely inspected motor can be measured at the same time as vibrations.



\*Use K6CM-VBSAT1, the adhesive attachment if the motor cannot be tapped.

Measuring vibration detection frequency up to 10 kHz can detect motor abnormalities at the earlier stage.

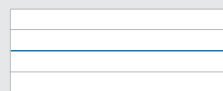
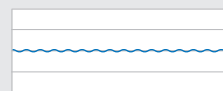
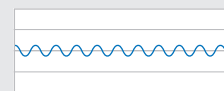
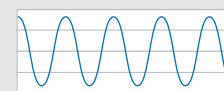
Bearing condition	 New	 Grease degraded	 Damages	 Breakdown
Motor condition	 Working smoothly	 Working smoothly	 Abnormal noise occurs	 Overheating/shaking
Motor vibration			 The values change shortly and rapidly when motors are shaking by damages. Monitored by acceleration.	 The values change largely and slowly when motors are shaking by breakdown. Monitored by velocity.
Measurement range by sensor	No vibration Out of range of measurement by sensor		High frequency Amplitude: small Acceleration 1 to 10 kHz Amplitude: medium Within range of measurement by acceleration	0.01 to 1 kHz Amplitude: large Velocity Within range of measurement by velocity

type 03 Constantly monitors the insulation resistance



# K6CM-IS



Insulation resistance monitoring type

## Measures insulation resistance

With conventional products, measurement with a Megger Tester was necessary to check for insulation degradation. K6CM-IS can be used to perform this inspection during operation, making it possible to constantly monitor degradation trends while reducing the burden on the maintenance personnel.

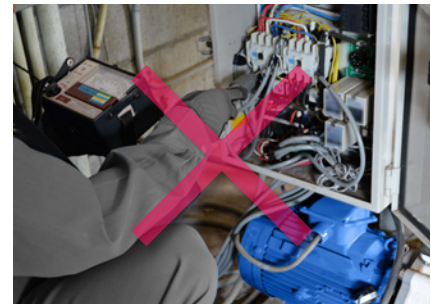

This eliminates the need for complicated insulation resistance measurements.

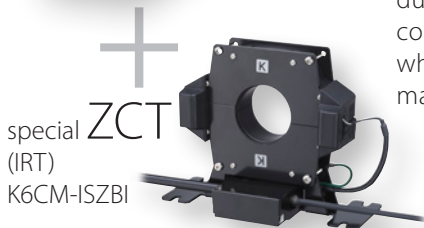

The insulation resistance at the secondary side of an inverter can be measured.

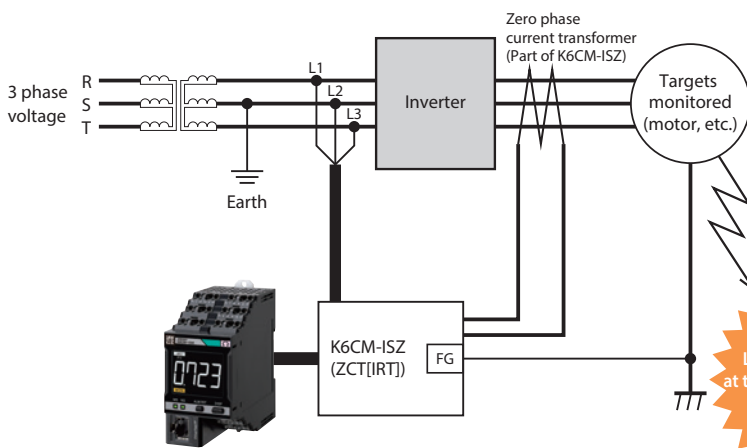

Previously, measuring insulation resistance has been difficult because the leakage current at the secondary side of an inverter repeatedly increase and decrease due to the gap between commercial current and inverter current. K6CM-IS can measure the leakage current at the secondary side of an inverter by OMRON's unique technology.



The image of the leakage current waveform at the secondary side of an inverter.

The current value increase and decrease repeatedly.

\*The measurement of insulation resistance needs about 10 seconds while driving the motor by direct connection to commercial power supply and about 60 seconds by the inverter.

# Features Three functions for monitoring motor condition

## 1 Visual inspection through alarm bar display and two-step output

### Alarm bar and output function

The K6CM series is equipped with an "alarm bar display" on the front of the product. The condition of motor is displayed by color-coding as green, yellow, or red. This shows the degree of abnormality and is helpful for visual inspection near the motor. Accordingly "failure warning" and "failure critical" statuses are also output. In addition, by using "display auto switching mode", you can see the measurement value in each without operation.

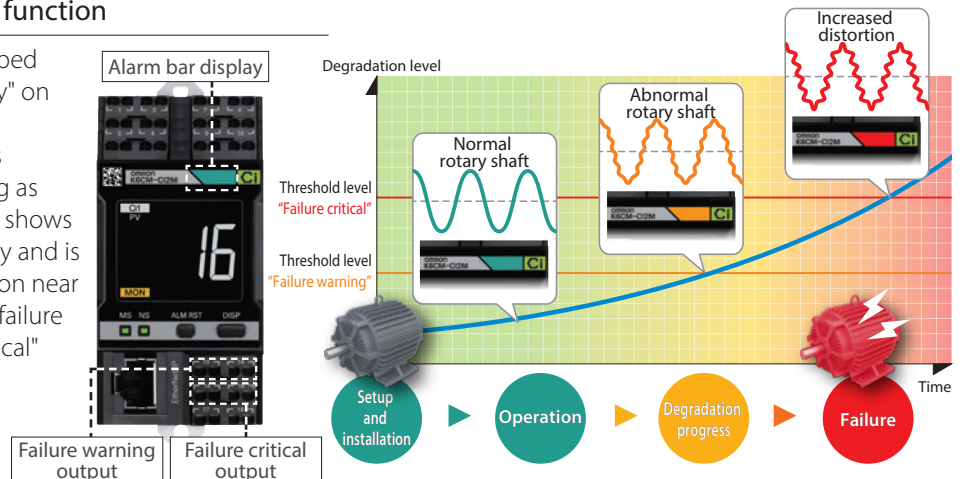

## 2 Monitors stable values even when load fluctuates

### Trigger input function

Equipped with a "trigger input function" that measures the measurement timing according to the motor operation in order to accurately diagnose the condition of motors that are repeatedly started and stopped. The motor condition is determined from the operation signals (auxiliary output of the contactor and the PLC control signal), and measurement is only performed when the motor operation is stabilized, enabling fixed point observation on a daily or monthly basis under the same conditions. And the monitoring delay time function can be used to wait for the measurement values to stabilize. This function can delay the start of monitoring after the trigger input.

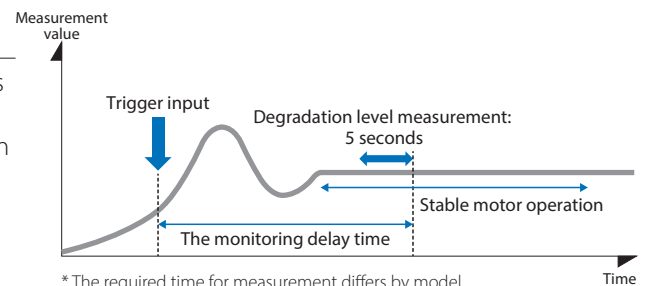

## 3 Self-diagnosis function that improves system reliability

### Self-diagnosis function

When constantly monitoring for a long period of time, unexpected failures and other problems of measuring devices must be taken into consideration. The K6CM series is equipped with a self-diagnosis function as standard. The reliability of the system is improved by monitoring the service life of the device to be measured.



### Status display "AGE"

Lights up when the guideline for the replacement time is reached.



# Condition Monitoring Configuration Tool

## Easy three-step configuration

Setup can be completed in just three steps: communications setup, initial setup, and trigger setup.

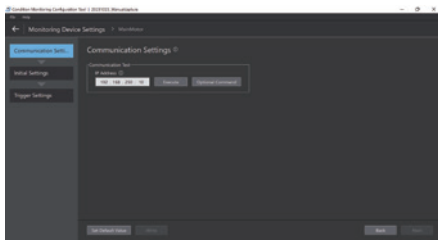

Communications setup

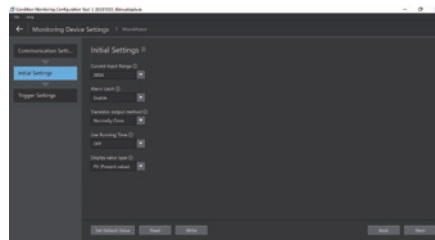

Initial setup

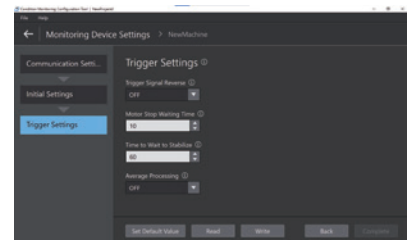

Trigger setup

## Alarm Setting Guide (K6CM-VB Vibration & temperature type only)

The Acceleration alarm, velocity alarm threshold setting guide is displayed on the right side of the Alarm Settings Screen for K6CM-VB. You can automatically set the threshold by entering the Motor shaft diameter, Rotation speed, capacity and so on.

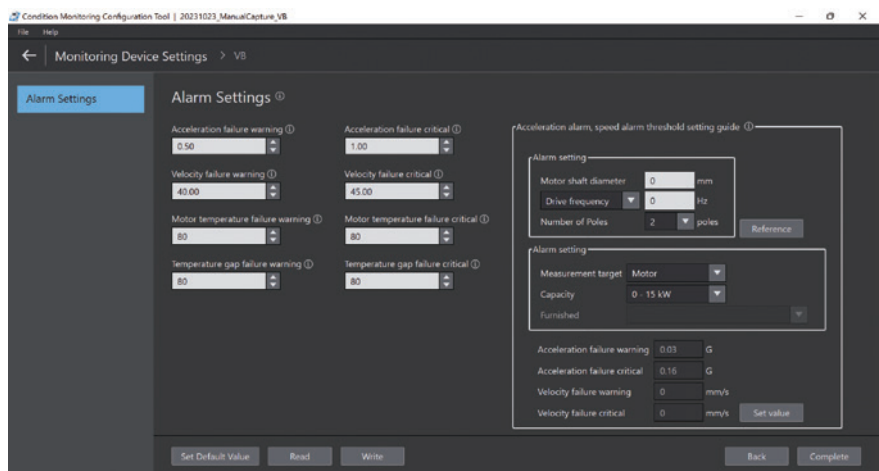

## Trend Monitoring

You can check the trend of the measured values in a graph on the screen. In addition, you can also visually check the status of the condition monitoring device connected to the network on the same screen with icons.

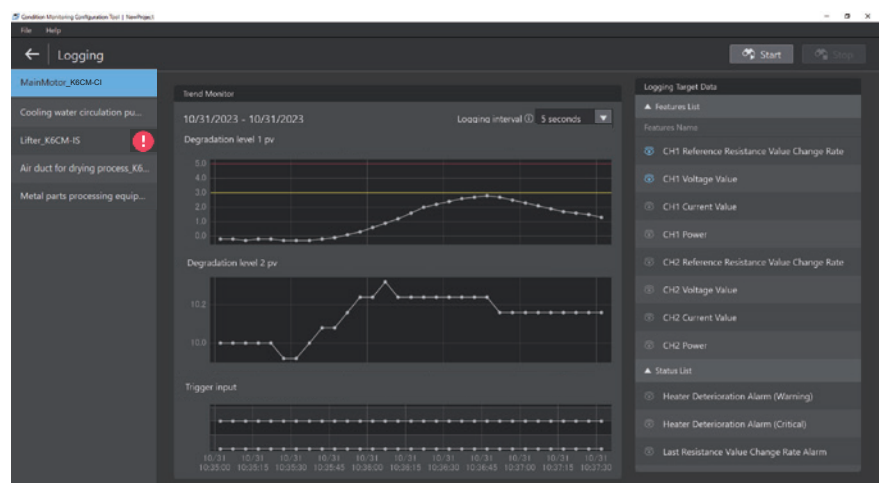







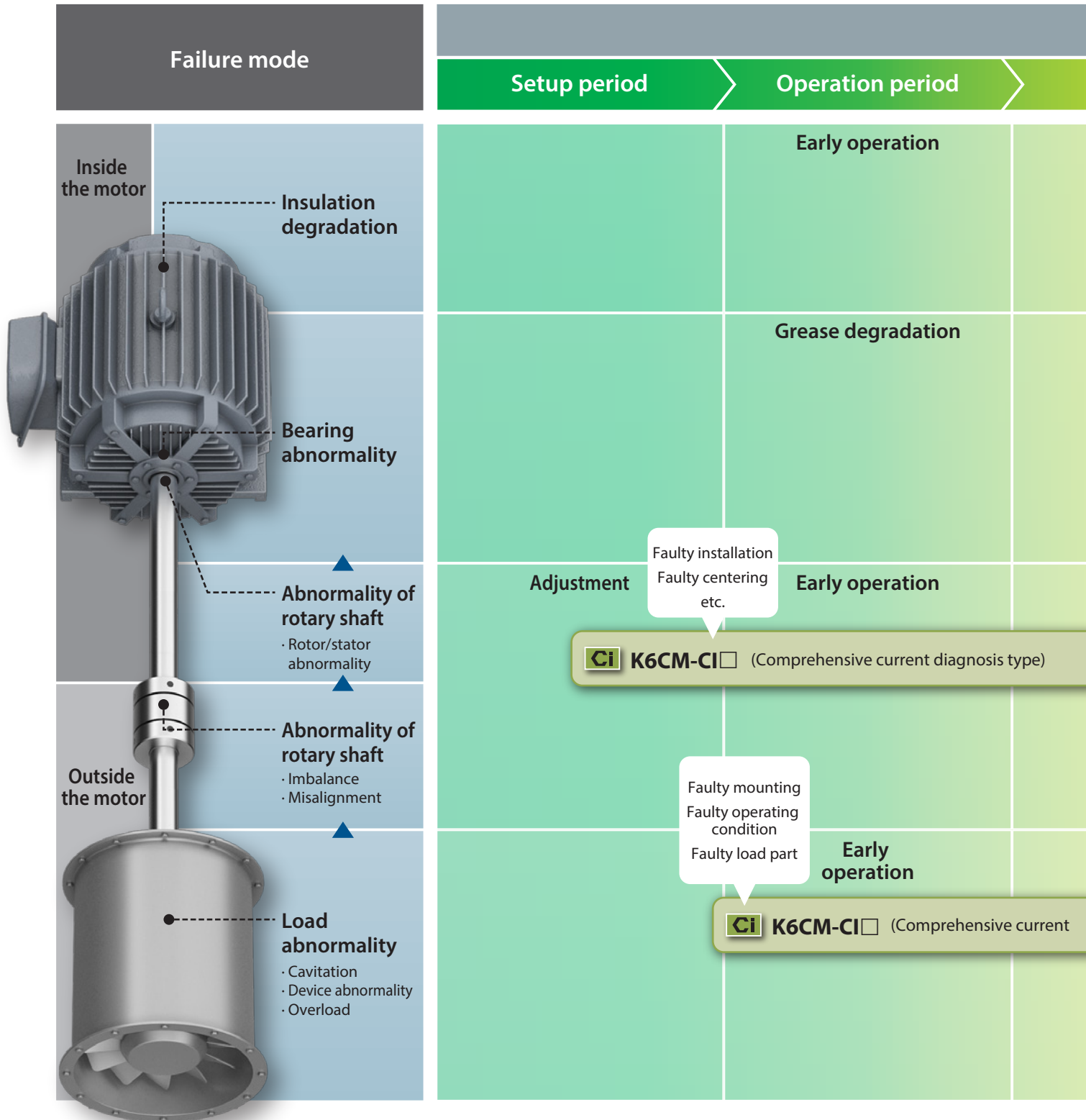

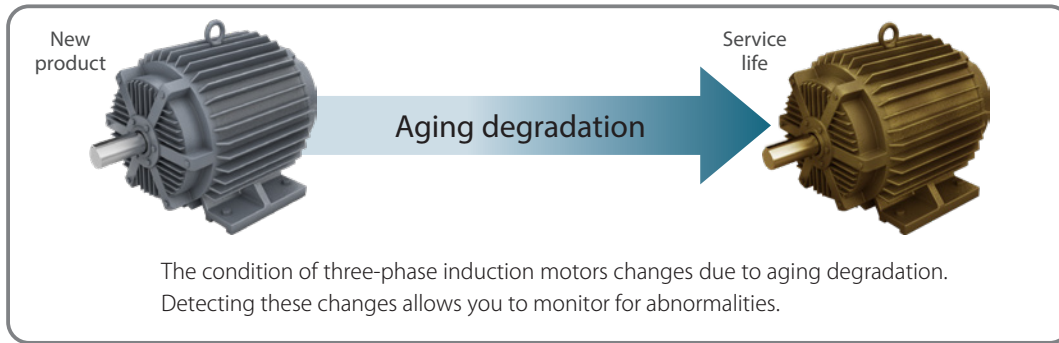
# Degradation progress/failure mode correspondence table

After installing a three-phase induction motor, performing proper maintenance by monitoring the motor condition will prolong its service life.

Please select the optimal model for the type of abnormality you want to detect.





Motor and load condition	
Degradation progress period	Breakdown period
<b>Insulation degradation</b> 	<b>Insulation breakdown</b>
 <b>K6CM-IS</b> (Insulation resistance monitoring type) [Insulation degradation]	
<b>Bearing damage</b> 	<b>Bearing breakdown</b>
 <b>K6CM-CI</b> (Comprehensive current diagnosis type) [Degradation level]	
 <b>K6CM-VB</b> (Vibration & temperature monitoring type) [Acceleration]	
<b>Degradation progress of motor</b> [Degradation level]	
 <b>K6CM-VB</b> (Vibration & temperature monitoring type) [Velocity]	
<b>Degradation progress of load</b> diagnosis type) [Degradation level]	
 <b>K6CM-VB</b> (Vibration & temperature monitoring type) [Velocity]	

 **K6CM-CI** (Comprehensive current diagnosis type) [Overcurrent]

 **K6CM-VB** (Vibration/temperature monitoring type) [Temperature]

The measurement value in each model is a typical example.

- Windows is either a registered trademark or trademark of Microsoft Corporation in the United States and/or other countries.
- EtherNet/IP™ is a trademark of ODVA.
- Modbus is a registered trademark or trademark of Schneider Electric USA, Inc. in Japan, the United States or other countries.
- TPM trademarks and logos are registered trademarks or trademarks of the Japan Institute of Plant Maintenance in Japan and other countries.
- Other company names and product names in this document are the trademarks or registered trademarks of their respective companies.
- Some images are used under license from Shutterstock.com.
- Before you place an order, please read and understand "Terms and Conditions Agreement" on K6CM Datasheet (Cat. No. N218).

**Note: Do not use this document to operate the Unit.**

## **OMRON Corporation Industrial Automation Company**

**Kyoto, JAPAN**

**Contact : [www.ia.omron.com](http://www.ia.omron.com)**

### **Regional Headquarters**

#### **OMRON EUROPE B.V.**

Wegalaan 67-69, 2132 JD Hoofddorp  
The Netherlands  
Tel: (31) 2356-81-300 Fax: (31) 2356-81-388

#### **OMRON ELECTRONICS LLC**

2895 Greenspoint Parkway, Suite 200  
Hoffman Estates, IL 60169 U.S.A.  
Tel: (1) 847-843-7900 Fax: (1) 847-843-7787

#### **OMRON ASIA PACIFIC PTE. LTD.**

438B Alexandra Road, #08-01/02 Alexandra  
Technopark, Singapore 119968  
Tel: (65) 6835-3011 Fax: (65) 6835-2711

#### **OMRON (CHINA) CO., LTD.**

Room 2211, Bank of China Tower,  
200 Yin Cheng Zhong Road,  
PuDong New Area, Shanghai, 200120, China  
Tel: (86) 21-5037-2222 Fax: (86) 21-5037-2200

**Authorized Distributor:**

©OMRON Corporation 2017-2023 All Rights Reserved.  
In the interest of product improvement,  
specifications are subject to change without notice.

**CSM\_2\_1**

**Cat. No. N220-E1-09** 1223 (1117)