

Klemsan[®]



**KLEMSAN TRUNKIE
WIRING DUCTS,
HALOGEN FREE AND
ACCESSORIES CATALOGUE**

PC/ABS

LOW SMOKE HALOGEN FREE

ELEGANCE IN THE PANELS

Why Klemsan Trunkie?

- New** • LSHF Low Smoke Halogen Free Wiring Ducts Family.
- Upper scoreline provides easy breaking off the ribs.
- Lower scoreline provides easy splitting of wiring duct's base and wall.
- Special rib pattern design allows more proper wire placement.
- Wiring duct covers hold securely even in a vertical position and under vibration.
- Trunkie helps you save time while breaking off ribs in group without using any tools.

IEC 60695-2-12

UL94-V0

PVC













EN50085-2-3

EN45545-2

1. Halogen Free For Highest Safety	06
1.1 Why Low Smoke Halogen Free (LSHF) Products?	06
1.2 The Difference Between PVC and PC/ABS	06
1.3 EN 45545-2 European Union Standards	07
1.4 LSHF Material Properties - PC/ABS Raw Material	07
2. LSHF (Low Smoke Halogen Free) - Wiring Ducts	08
2.1 LSHF - Wiring Duct Covers	08
3. Klemsan Trunkie Rigid PVC Wiring Ducts	09
New PVC Wiring Duct with Additional Holes	09
3.1 Solutions Which Simplify Wiring	09
3.2 Durability and Reliability	09
3.3 Appearance	09
3.4 Speed and Efficiency	09
4. PVC Wiring Ducts Product Range	10
4.1 PVC Wiring Duct with Additional Holes - KKD Series	10
4.2 PVC Wiring Duct with Additional Holes (Wide Slotted) - KKD Series	11
4.3 PVC Wiring Duct (Medium Slotted) - KKC Series	12
4.4 PVC Wiring Duct (Narrow Slotted) - KKC Series	13
4.5 PVC Wiring Duct (Wide Slotted) - KKC Series	14
4.6 Wiring Ducts Covers	15
4.7 Wiring Duct Accessories	16
4.8 Wiring Duct Cutters	17
4.9 Technical Specifications	18 - 19

Application Areas of Halogen Free Wiring Ducts

Preferred and applied in public areas, such as;

-  Hospitals
-  Schools
-  Railway Industries
-  Subway and Highway Tunnels
-  Laboratories
-  Shopping Centers
-  Cinema and Theater Halls
-  Mining Facilities
-  Airport Terminals
-  Hotels
-  Multistory and High Buildings
-  Airplanes
-  Marine Industries

HALOGEN FREE Wiring Ducts

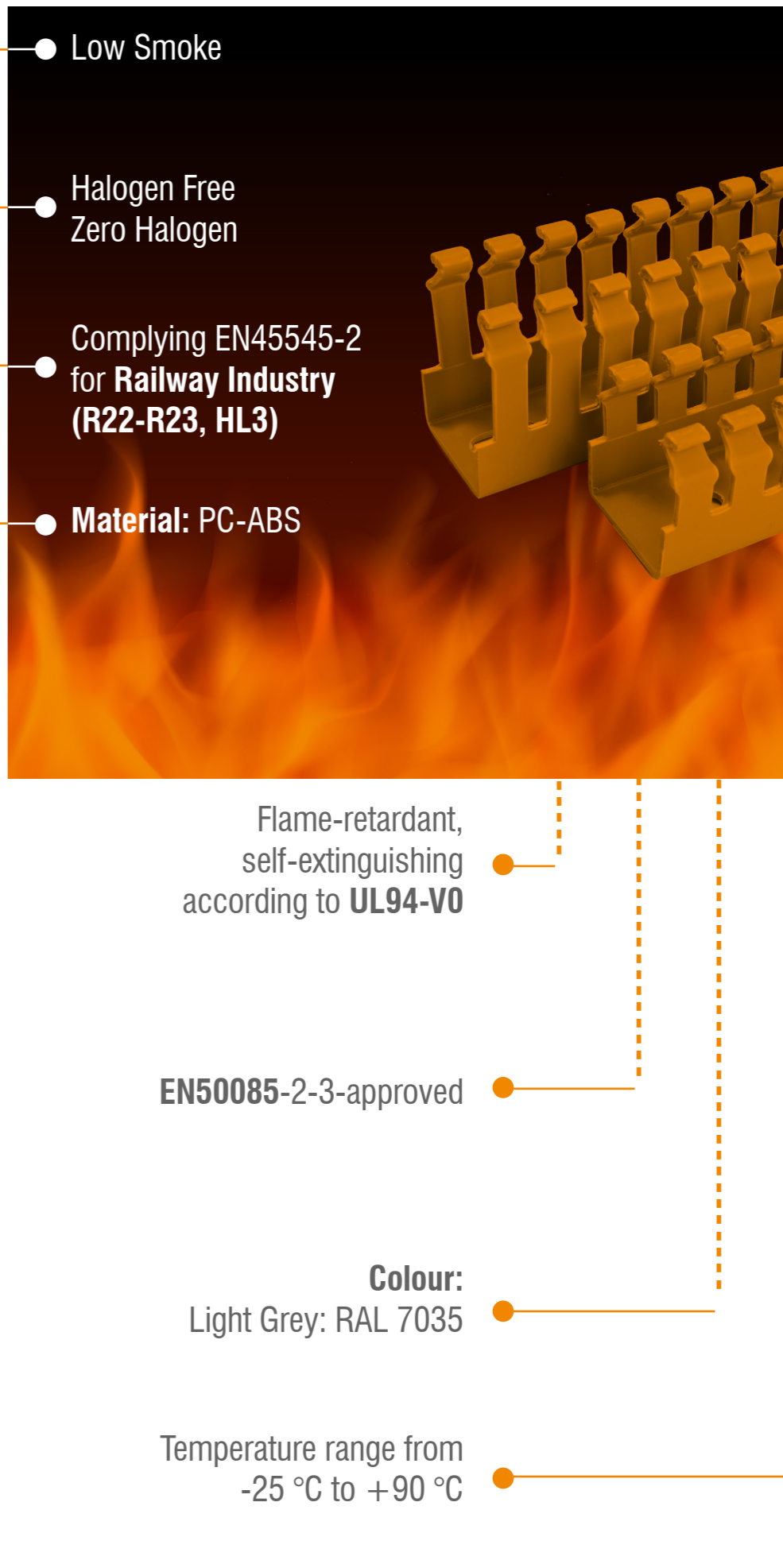

- Low Smoke
- Halogen Free Zero Halogen
- Complying EN45545-2 for Railway Industry (R22-R23, HL3)
- Material: PC-ABS
- Flame-retardant, self-extinguishing according to **UL94-V0**
- **EN50085-2-3-approved**
- Colour: Light Grey: RAL 7035
- Temperature range from -25 °C to +90 °C

1. Halogen Free For Highest Safety



1.1 Why Low Smoke Halogen Free (LSHF) products?

When PVC or other traditional plastics ignite in a fire, they emit **corrosive & toxic gases** like Chlorine. Moreover, these are soluble in moisture, forming Hydrochloric acid, which **destroy** electronics, semiconductors and intrinsic electrical circuits.

It can be fatally hazardous to humans if they cannot escape from the smoky area contaminated with toxic elements. Toxic fumes are not only a serious health risk but also cause serious damage and problems to crucial machineries.

1.2 The Difference Between PVC and PC/ABS

Due to its high level of flame-retardancy, PVC has been used as an appropriate cable insulation material for many years. However, in the event of a fire this will generate dense black smoke, with toxic and corrosive gases that can cause fatality and destruction.

✓ PC/ABS passes the Halogen free tests and Low Smoke tests **successfully**.

Halogen Free wires and cables are already compulsory in many areas as they are safer. In the same way, Halogen Free Wiring Duct is especially important to be used **in closed areas where the exits are limited**; such as Public Transport, Hospitals, Malls etc.

dense
PVC generates
black smoke when it burns

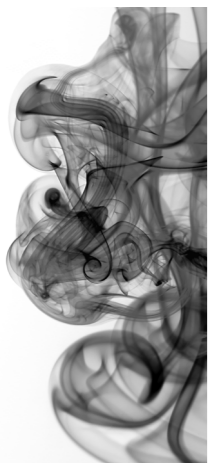

1.3 EN 45545-2 European Union Standards Fire Testing to Railway Components

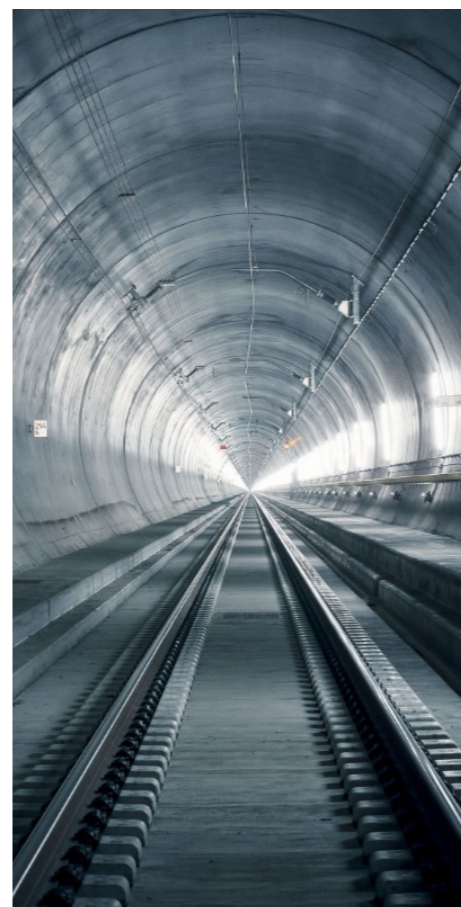

KLEMSAN offers a wide range of Wiring Ducts in materials that are compliant with the smoke generation and toxicity requirements of the **EN 45545-2 European Railway Standards** for fire safety classes **R22 - R23** and Hazard Levels **HL1 - HL2 - HL3**.

Vehicles are classified as: HL1, HL2 or HL3, depending on their time in tunnels and the availability of sleeping cars. The HL1 classification represents the lowest hazard level and HL3 represents the highest. Please refer to **EN 45545-2** for definitions.



1.4 LSHF Material Properties - PC/ABS Raw Material



Our Halogen Free Wiring Ducts are made of a special purpose **LSHF** and flame retardant **PC/ABS** blend containing **NO Bromide, NO Chlorine** and **NO Fluorine**. It still offers high impact resistance and excellent characteristics used for higher temperature applications. These are in compliance with **EN 45545-2 European Union Standards**.

LSHF material also has characteristics of **self-extinguishing**, **UL94** flammability rating of **V-0**. It is **RoHS** compliant, environmentally safe and is 20% lighter than PVC.

Our LSHF material is resistant to abnormal heat and fire. It has proven dimensional stability between **-25 °C / + 90 °C**.

Also, the Halogen Free Wiring Ducts are manufactured in compliance with the Standard **EN 50085-2-3**. Ideal for applications where public safety during a fire is a concern.

2. LSHF (Low Smoke Halogen Free) - Wiring Ducts

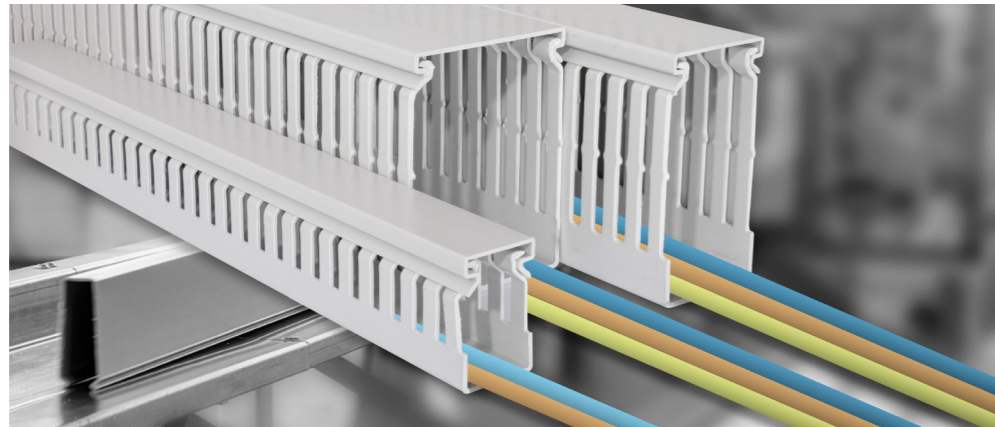
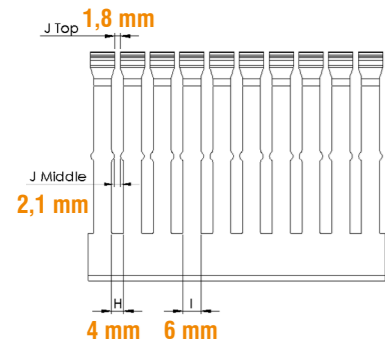

Order No	Product	Size WxH (mm)	Color	Qty.
540 010	KHF 2530 Wiring Duct	25X30	Grey ●	46x2 m
540 020	KHF 2540 Wiring Duct	25X40	Grey ●	50x2 m
540 030	KHF 2560 Wiring Duct	25X60	Grey ●	30x2 m
540 060	KHF 4040 Wiring Duct	40X40	Grey ●	24x2 m
540 070	KHF 4060 Wiring Duct	40X60	Grey ●	18x2 m
540 080	KHF 4080 Wiring Duct	40X80	Grey ●	20x2 m
540 100	KHF 6040 Wiring Duct	60X40	Grey ●	18x2 m
540 110	KHF 6060 Wiring Duct	60X60	Grey ●	12x2 m
540 120	KHF 6080 Wiring Duct	60X80	Grey ●	12x2 m
540 150	KHF 8060 Wiring Duct	80X60	Grey ●	14x2 m
540 160	KHF 8080 Wiring Duct	80X80	Grey ●	10x2 m

- Flame-retardant, self-extinguishing according to UL94-V0
- Excellent fire-safety characteristics.
- Smooth, burr-free edges protect installers from injury and wires from damage.
- Ribs can be removed easily thanks to upper scorlines.
- Lower scorlines at base of sidewall allow cutting out and removing sections of sidewall with no sharp edges.
- Duct covers hold securely even in a vertical position and under vibration.

* Wiring duct covers are included the package.

2.1 LSHF - Wiring Duct Covers

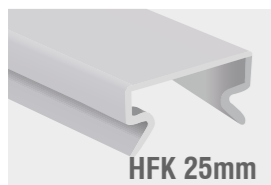

HFK 25mm

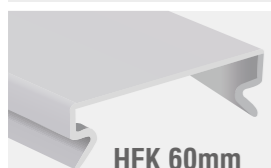

HFK 60mm

Order No	Product	Size (mm)	Color
540 600	HFK 25mm Wiring Duct Cover	25	Grey ●
540 610	HFK 40mm Wiring Duct Cover	40	Grey ●
540 620	HFK 60mm Wiring Duct Cover	60	Grey ●
540 630	HFK 80mm Wiring Duct Cover	80	Grey ●



3. Klemsan "Trunkie" PVC Wiring Ducts

Klemsan "Trunkie" Wiring Ducts now available with the **new** design!

Thanks to additional hole on the side, you can use cable ties to group your cables, this makes your projects more practical. You can easily mount wire retainers on the bottom rail of the duct without screw and slide them along the rail. Lower and upper scorline is also available for breaking off the ribs easily and burr free.



3.1 Solutions Which Simplify Wiring

- Now wire management is much easier.
- You can easily mount wire retainers on the bottom rail of the duct without screw and slide them along the rail.

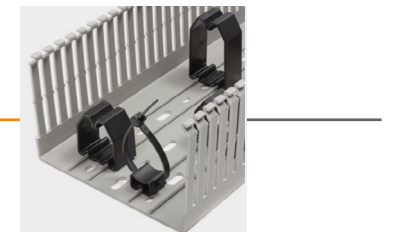

3.2 Durability and Reliability

- Assembly or disassembly of the covers is the most difficult operation when ducts are fully wired, design of Trunkie speeds up your work.
- Trunkie enables the customer to use the maximum inner space of the duct and keeps the rigidity even at maximum load of cables.

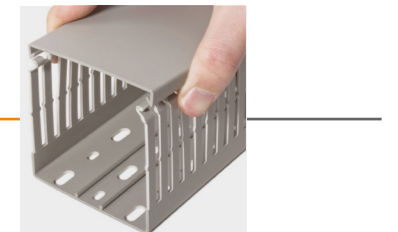

3.3 Appearance

- Special rib pattern allows the end-user to make cable grouping easier.
- Can be used with cable tie thanks to additional holes on the sides.

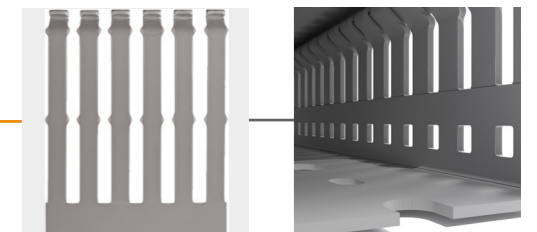

3.4 Speed and Efficiency

- Furthermore, Trunkie helps you save time while breaking off ribs in groups.
- Without using any hand tools,

simply bend the duct ribs and easily break them inside the panel.

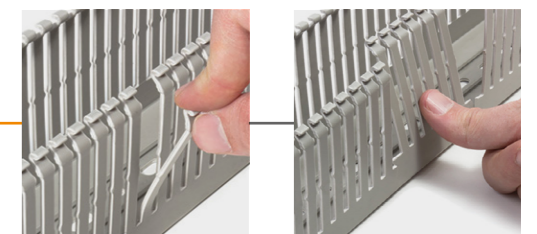

4. PVC Wiring Ducts Product Range

4.1 PVC Wiring Duct with Additional Holes KKD Series

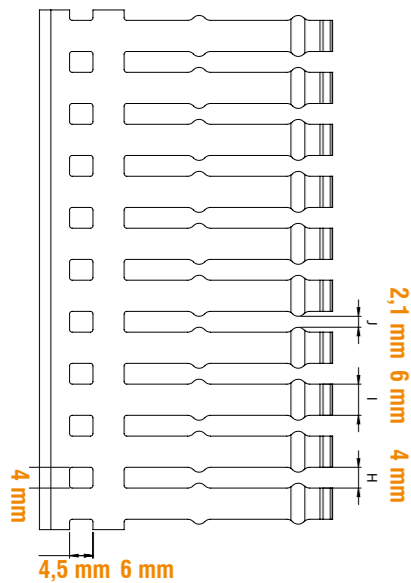

Order No	Product	Size WxH (mm)	Color	Qty.
555 2530	KKD 2530	25x30	Grey ●	50x2 m
555 2540	KKD 2540	25x40	Grey ●	50x2 m
555 2560	KKD 2560	25x60	Grey ●	30x2 m
555 2580	KKD 2580	25x80	Grey ●	28x2 m
555 2510	KKD 2510	25x100	Grey ●	22x2 m
555 4040	KKD 4040	40x40	Grey ●	26x2 m
555 4060	KKD 4060	40x60	Grey ●	18x2 m
555 4080	KKD 4080	40x80	Grey ●	20x2 m
555 4010	KKD 4010	40x100	Grey ●	14x2 m
555 6040	KKD 6040	60x40	Grey ●	18x2 m
555 6060	KKD 6060	60x60	Grey ●	12x2 m
555 6080	KKD 6080	60x80	Grey ●	12x2 m
555 6010	KKD 6010	60x100	Grey ●	18x2 m
555 8040	KKD 8040	80x40	Grey ●	18x2 m
555 8060	KKD 8060	80x60	Grey ●	14x2 m
555 8080	KKD 8080	80x80	Grey ●	10x2 m
555 8010	KKD 8010	80x100	Grey ●	12x2 m
555 1006	KKD 1006	100x60	Grey ●	10x2 m
555 1008	KKD 1008	100x80	Grey ●	8x2 m
555 1001	KKD 1001	100x100	Grey ●	12x2 m
555 1206	KKD 1206	120x60	Grey ●	8x2 m
555 1208	KKD 1208	120x80	Grey ●	6x2 m
555 1201	KKD 1201	120x100	Grey ●	10x2 m

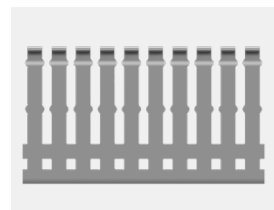

- Can be used with cable tie thanks to additional holes on the sides.
- Flame-retardant, self-extinguishing according to UL94-V0
- Upper scorline is available for breaking off the ribs.
- Lower scorline is available.
- **Operating Temperature:** -5°C to 60°C
- **Standard Length:** 2 meters
- **Color Option:** RAL 7030 Grey
- Complies with RoHS regulations.
- Complies with IEC 60695-2-1 and EN 50085-2-3 standards.

* Wiring duct covers are included the package.



4. PVC Wiring Ducts Product Range

4.2 PVC Wiring Duct with Additional Holes (Wide Slotted) KKD Series

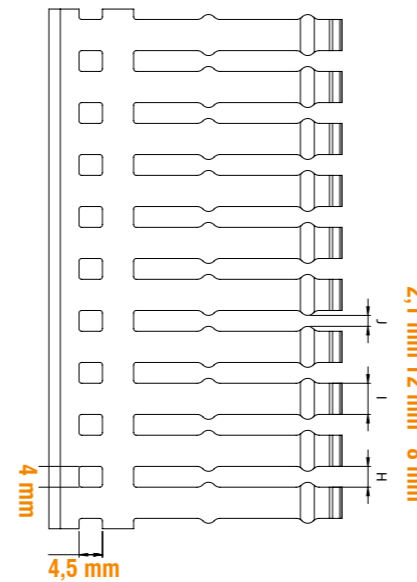

Order No	Product	Size WxH (mm)	Color	Qty.
555 4060WS	KKD 4060	40x60	Grey ●	50x2 m
555 4080WS	KKD 4080	40x80	Grey ●	50x2 m
555 4010WS	KKD 4010	40x100	Grey ●	30x2 m
555 6060WS	KKD 6060	60x60	Grey ●	28x2 m
555 6080WS	KKD 6080	60x80	Grey ●	22x2 m
555 6010WS	KKD 6010	60x100	Grey ●	26x2 m
555 8060WS	KKD 8060	80x60	Grey ●	18x2 m
555 8080WS	KKD 8080	80x80	Grey ●	20x2 m
555 8010WS	KKD 8010	80x100	Grey ●	14x2 m
555 1006WS	KKD 1006	100x60	Grey ●	18x2 m
555 1008WS	KKD 1008	100x80	Grey ●	12x2 m
555 1001WS	KKD 1001	100x100	Grey ●	12x2 m
555 1206WS	KKD 1206	120x60	Grey ●	18x2 m
555 1208WS	KKD 1208	120x80	Grey ●	18x2 m
555 1201WS	KKD 1201	120x100	Grey ●	14x2 m
555 1501WS	KKD 1501	150x100	Grey ●	10x2 m

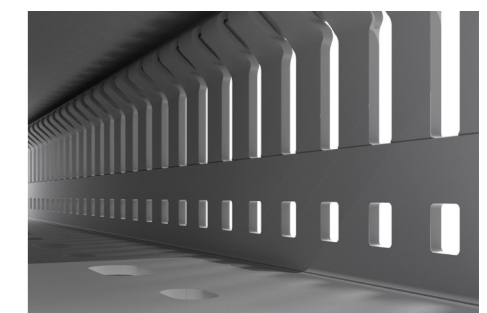
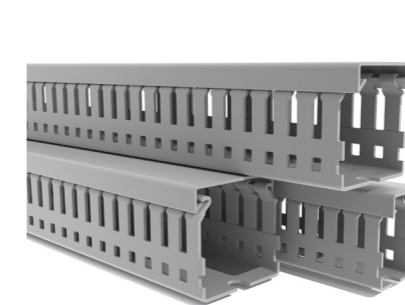
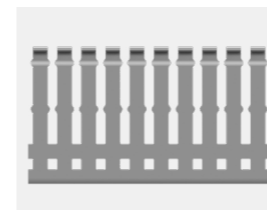
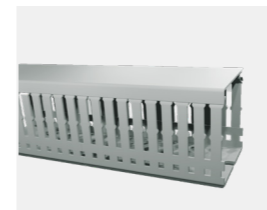

- Can be used with cable tie thanks to additional holes on the sides.
- Flame-retardant, self-extinguishing according to UL94-V0
- Upper scorline is available for breaking off the ribs.
- Lower scorline is available.
- **Operating Temperature:** -5°C to 60°C
- **Standard Length:** 2 meters
- **Color Option:** RAL 7030 Grey
- Complies with RoHS regulations.
- Complies with IEC 60695-2-1 and EN 50085-2-3 standards.

* Wiring duct covers are included the package.



4. PVC Wiring Ducts Product Range

4.3 PVC Wiring Duct (Medium Slotted) - KKC Series

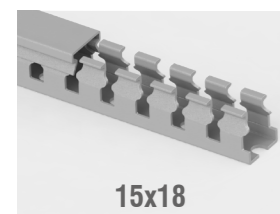
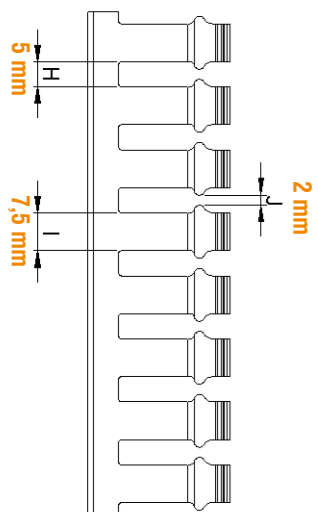

15x18

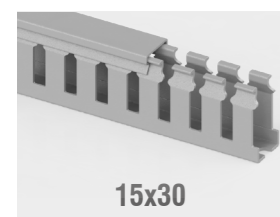

15x30

Self-adhesive

Order No	Product	Size WxH (mm)	Color	Qty.
551 060YP	KKC 1518	15x18	Grey ●	122x2 m
551 070YP	KKC 1530	15x30	Grey ●	104x2 m
551 080YP	KKC 1540	15x40	Grey ●	80x2 m
551 090YP	KKC 1560	15x60	Grey ●	42x2 m
551 060	KKC 1518	15x18	Grey ●	126x2 m
551 070	KKC 1530	15x30	Grey ●	106x2 m
551 080	KKC 1540	15x40	Grey ●	80x2 m
551 090	KKC 1560	15x60	Grey ●	42x2 m

- Flame-retardant, self-extinguishing according to UL94-V0
- No lower scorline available for this range.
- Upper scorline is available for breaking off the ribs.
- **Operating Temperature:** -5°C to 60°C
- **Standard Length:** 2 meters
- **Color Option:** RAL 7030 Grey
- Complies with RoHS regulations.
- Complies with IEC 60695-2-1 and EN 50085-2-3 standards

* Wiring duct covers are included the package.



4. PVC Wiring Ducts Product Range

4.4 PVC Wiring Duct (Narrow Slotted) - KKC Series

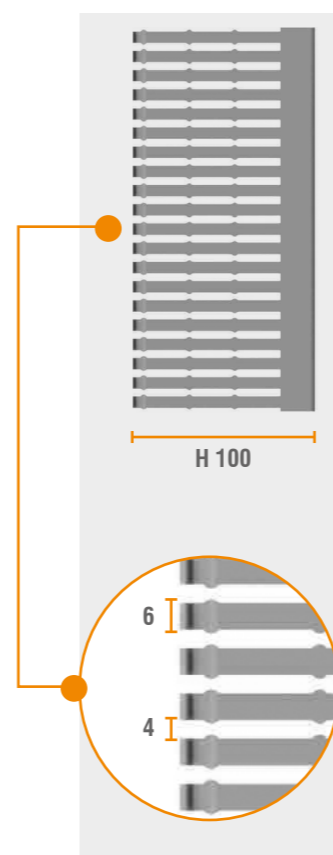
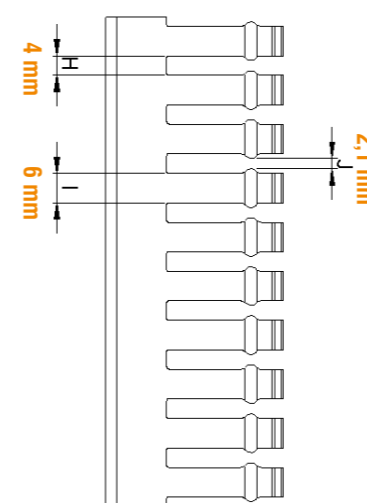

Order No	Product	Size WxH (mm)	Color	Qty.
551 010	KKC 2530	25x30	Grey ●	50x2 m
551 011	KKC 2540	25x40	Grey ●	50x2 m
551 012	KKC 2560	25x60	Grey ●	30x2 m
551 030	KKC 2580	25x80	Grey ●	28x2 m
551 031	KKC 2510	25x100	Grey ●	22x2 m
551 013	KKC 4040	40x40	Grey ●	26x2 m
551 014	KKC 4060	40x60	Grey ●	18x2 m
551 015	KKC 4080	40x80	Grey ●	20x2 m
551 032	KKC 4010	40x100	Grey ●	14x2 m
551 016	KKC 6040	60x40	Grey ●	18x2 m
551 017	KKC 6060	60x60	Grey ●	12x2 m
551 018	KKC 6080	60x80	Grey ●	12x2 m
551 033	KKC 6010	60x100	Grey ●	18x2 m
551 034	KKC 8040	80x40	Grey ●	18x2 m
551 019	KKC 8060	80x60	Grey ●	14x2 m
551 020	KKC 8080	80x80	Grey ●	10x2 m
551 035	KKC 8010	80x100	Grey ●	12x2 m
551 021	KKC 1006	100x60	Grey ●	10x2 m
551 022	KKC 1008	100x80	Grey ●	8x2 m
551 036	KKC 1001	100x100	Grey ●	12x2 m
551 023	KKC 1206	120x60	Grey ●	8x2 m
551 024	KKC 1208	120x80	Grey ●	6x2 m
551 025	KKC 1201	120x100	Grey ●	10x2 m

- Flame-retardant, self-extinguishing according to UL94-V0
- Upper scorline is available for breaking off the ribs.
- Lower scorline is available.
- **Operating Temperature:** -5°C to 60°C
- **Standard Length:** 2 meters
- **Color Option:** RAL 7030 Grey
- Complies with RoHS regulations.
- Complies with IEC 60695-2-12 and EN 50085-2-3 standards.

* Wiring duct covers are included the package.



4. PVC Wiring Ducts Product Range

4.5 PVC Wiring Duct (Wide Slotted) - KKC Series

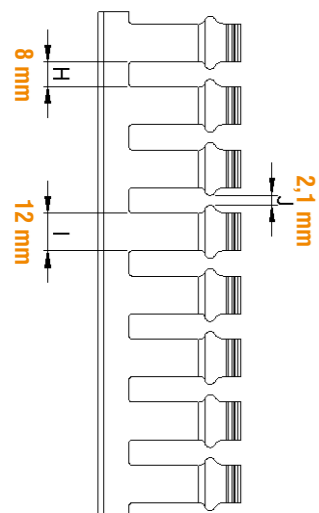

Order No	Product	Size WxH (mm)	Color	Qty.
551 014WS	KKC 4060	40x60	Grey	18x2 m
551 015WS	KKC 4080	40x80	Grey	20x2 m
551 032WS	KKC 4010	40x100	Grey	14x2 m
551 017WS	KKC 6060	60x60	Grey	12x2 m
551 018WS	KKC 6080	60x80	Grey	12x2 m
551 033WS	KKC 6010	60x100	Grey	18x2 m
551 019WS	KKC 8060	80x60	Grey	14x2 m
551 020WS	KKC 8080	80x80	Grey	10x2 m
551 035WS	KKC 8010	80x100	Grey	12x2 m
551 021WS	KKC 1006	100x60	Grey	10x2 m
551 022WS	KKC 1008	100x80	Grey	8x2 m
551 036WS	KKC 1001	100x100	Grey	12x2 m
551 023WS	KKC 1206	120x60	Grey	8x2 m
551 024WS	KKC 1208	120x80	Grey	6x2 m
551 025WS	KKC 1201	120x100	Grey	10x2 m
551 040WS	KKC 1501	150x100	Grey	8x2 m

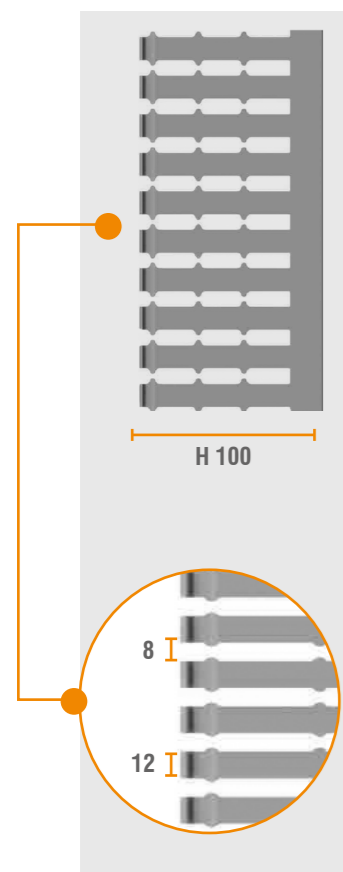

- Flame-retardant, self-extinguishing according to UL94-V0
- Upper scorline is available for breaking off the ribs.
- Lower scorline is available.
- **Operating Temperature:** -5°C to 60°C
- **Standard Length:** 2 meters
- **Color Option:** RAL 7030 Grey
- Complies with RoHS regulations.
- Complies with IEC 60695-2-1 and EN 50085-2-3 standards.

* Wiring duct covers are included the package.

4. PVC Wiring Ducts Product Range

4.6 Wiring Ducts Covers

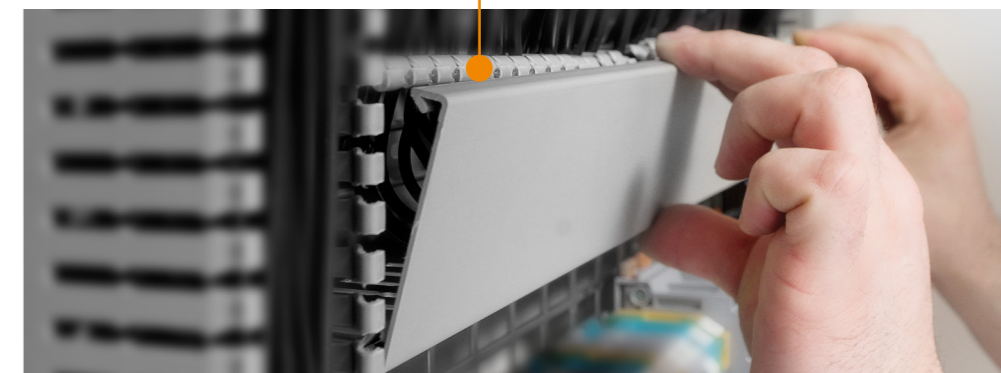

Order No	Product	Size (mm)	Color	Description	Qty.
551 049	KKK 15	15	Grey	KKK 15 mm Wiring Duct Cover	10x2 m
551 050	KKK 25	25	Grey	KKK 25 mm Wiring Duct Cover	10x2 m
551 051	KKK 40	40	Grey	KKK 40 mm Wiring Duct Cover	10x2 m
551 052	KKK 60	60	Grey	KKK 60 mm Wiring Duct Cover	10x2 m
551 053	KKK 80	80	Grey	KKK 80 mm Wiring Duct Cover	10x2 m
551 054	KKK 100	100	Grey	KKK 100 mm Wiring Duct Cover	10x2 m
551 055	KKK 120	120	Grey	KKK 120 mm Wiring Duct Cover	10x2 m
551 056	KKK 150	150	Grey	KKK 150 mm Wiring Duct Cover	10x2 m

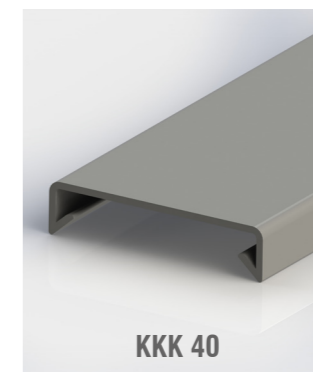
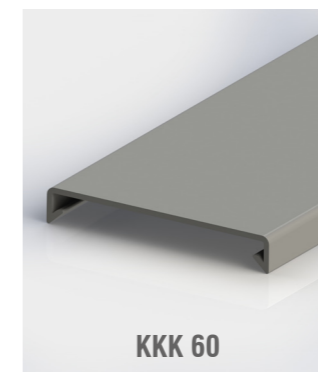
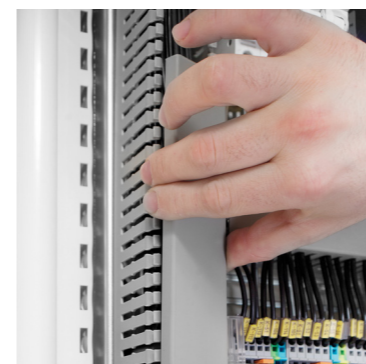

4. PVC Wiring Ducts Product Range

4.7 Wiring Duct Accessories

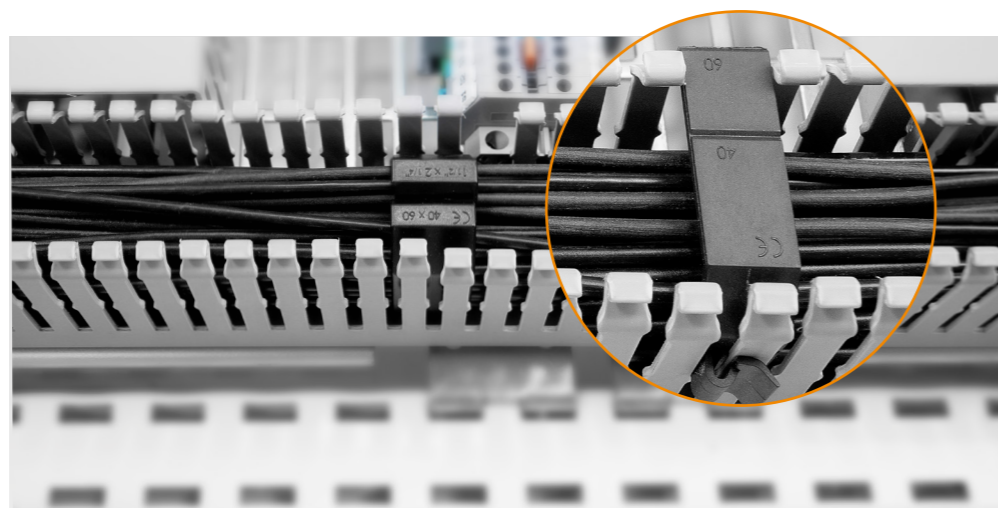

Order No	Product	Color		Description	Qty.
553 315	KKT 4040	Black	●	Wire Retainer	10
553 325	KKT 4060	Black	●	Wire Retainer	10
553 335	KKT 6080	Black	●	Wire Retainer	10
553 345	KKT 4080	Black	●	Wire Retainer	10
553 355	KKT 6040	Black	●	Wire Retainer	10
553 365	KKT 6060	Black	●	Wire Retainer	10
553 375	KKT 6010	Black	●	Wire Retainer	10
553 385	KKT 8060	Black	●	Wire Retainer	10
553 395	KKT 1006	Black	●	Wire Retainer	10
553 425	KKT 1206	Black	●	Wire Retainer	10
553 435	KKT 8080	Black	●	Wire Retainer	10
553 445	KKT 8010	Black	●	Wire Retainer	10
553 455	KKT 1008	Black	●	Wire Retainer	10
553 465	KKT 1001	Black	●	Wire Retainer	10
553 475	KKT 1208	Black	●	Wire Retainer	10
553 485	KKT 1201	Black	●	Wire Retainer	10
553 500	SETR	-	○	Setting Tool for Rivets	1
553 600	PPE 6.5	Grey	●	Rivets	100
553 405	KKB	Black	●	Cable Clamp	10
553 415	KKM	Black	●	Cable Holder	10

4. PVC Wiring Ducts Product Range

4.8 Wiring Duct Cutters

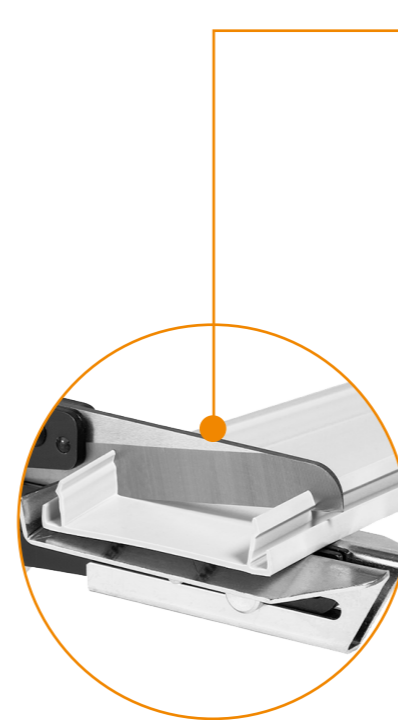

Order No	Product	Description	Qty.
553 230	KKMR	Wiring Duct Cutter (Hand Tool)	1

- Burr-free cutting of wiring ducts and wiring duct covers
- Straight or 45° cutting options
- Equal force distribution across blades helps homogenous cutting
- Cutting up to 100 mm width

Order No	Product	Description	Qty.
553 220	KMK 1002	Wiring Duct Cutting Tool up to 120 mm	1

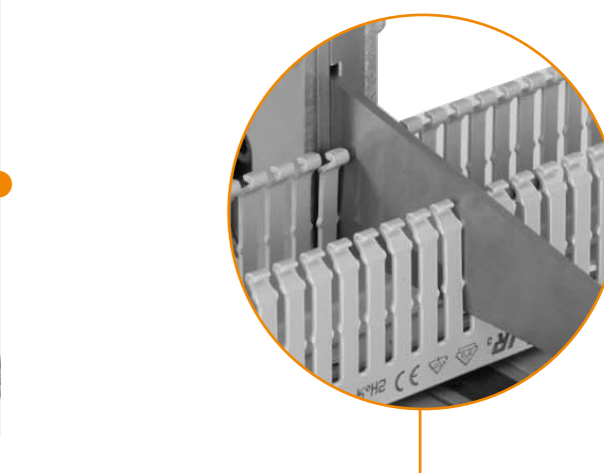

- Cover cutting
- Burr-free cutting
- Long-lived knife
- Length adjustment guide
- Cutting up to 120 mm width

4.9 Technical Specifications

Wire Retainer

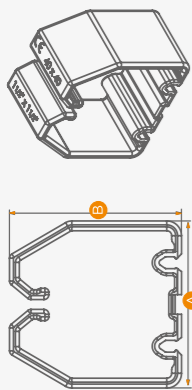

Wiring Duct

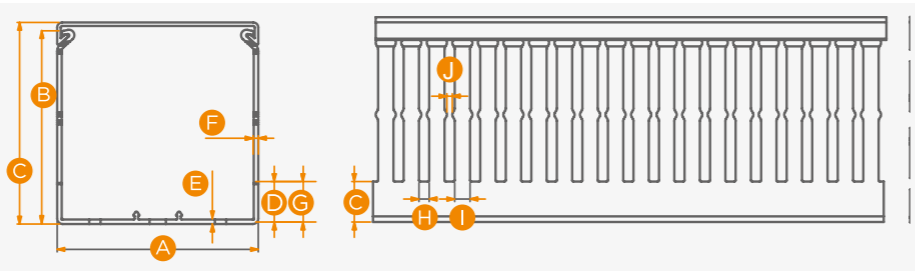

Order No.	Type	Description	Size (mm)									
			A	B	C	D	E	F	G	H	I	J
551 060	KKC 1518 - Medium	Wiring Duct	15	16,3	18	3,50	1,00	1,00	4,50	5	7,5	2
551 070	KKC 1530 - Medium	Wiring Duct	15	28,3	30	5,00	1,10	1,10	6,10	5	7,5	2
551 080	KKC 1540 - Medium	Wiring Duct	15	38,3	40	9,00	1,20	1,20	10,20	5	7,5	2
551 090	KKC 1560 - Medium	Wiring Duct	15	58,3	60	11,00	1,40	1,40	12,40	5	7,5	2
551 010	KKC 2530 - Narrow	Wiring Duct	25	26,4	30	10,00	1,40	1,40	11,40	4	6	2,1
551 011	KKC 2540 - Narrow	Wiring Duct	25	36,2	40	11,00	1,40	1,40	12,40	4	6	2,1
551 012	KKC 2560 - Narrow	Wiring Duct	25	56,4	60	12,00	1,60	1,60	13,60	4	6	2,1
551 030	KKC 2580 - Narrow	Wiring Duct	25	76,8	80	14,00	1,80	1,80	15,80	4	6	2,1
551 031	KKC 2510 - Narrow	Wiring Duct	25	96,6	100	16,00	1,90	1,90	17,90	4	6	2,1
551 013	KKC 4040 - Narrow	Wiring Duct	40	36,5	40	11,00	1,40	1,40	12,40	4	6	2,1
551 014	KKC 4060 - Narrow	Wiring Duct	40	56,5	60	12,00	1,60	1,60	13,60	4	6	2,1
551 015	KKC 4080 - Narrow	Wiring Duct	40	76,8	80	14,00	1,80	1,80	15,80	4	6	2,1
551 032	KKC 4010 - Narrow	Wiring Duct	40	96,9	100	16,00	1,90	2,00	17,90	4	6	2,1
551 016	KKC 6040 - Narrow	Wiring Duct	60	36,8	40	11,00	1,60	1,60	12,60	4	6	2,1
551 017	KKC 6060 - Narrow	Wiring Duct	60	56,8	60	12,00	1,80	1,80	13,80	4	6	2,1
551 018	KKC 6080 - Narrow	Wiring Duct	60	76,7	80	14,00	1,80	1,80	15,80	4	6	2,1
551 033	KKC 6010 - Narrow	Wiring Duct	60	96,9	100	16,00	2,00	2,00	18,00	4	6	2,1
551 034	KKC 8040 - Narrow	Wiring Duct	80	36,8	40	11,00	1,60	1,60	12,60	4	6	2,1
551 019	KKC 8060 - Narrow	Wiring Duct	80	57,0	60	12,00	1,80	1,80	13,80	4	6	2,1
551 020	KKC 8080 - Narrow	Wiring Duct	80	77,1	80	14,00	1,80	1,80	15,80	4	6	2,1
551 035	KKC 8010 - Narrow	Wiring Duct	80	97,2	100	16,00	2,20	2,20	18,20	4	6	2,1
551 021	KKC 1006 - Narrow	Wiring Duct	100	57,3	60	12,00	2,00	2,00	14,00	4	6	2,1
551 022	KKC 1008 - Narrow	Wiring Duct	100	77,2	80	14,00	2,00	2,00	16,00	4	6	2,1
551 036	KKC 1001 - Narrow	Wiring Duct	100	97,2	100	16,00	2,20	2,30	18,20	4	6	2,1
551 023	KKC 1206 - Narrow	Wiring Duct	120	57,6	60	12,00	2,30	2,00	14,30	4	6	2,1
551 024	KKC 1208 - Narrow	Wiring Duct	120	77,5	80	14,00	2,30	2,00	16,30	4	6	2,1
551 025	KKC 1201 - Narrow	Wiring Duct	120	97,5	100	16,00	2,40	2,40	18,40	4	6	2,1

Cable Clamp

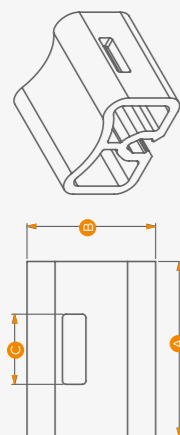

Cable Holder

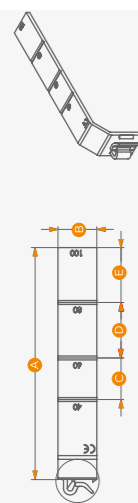

4.9 Technical Specifications

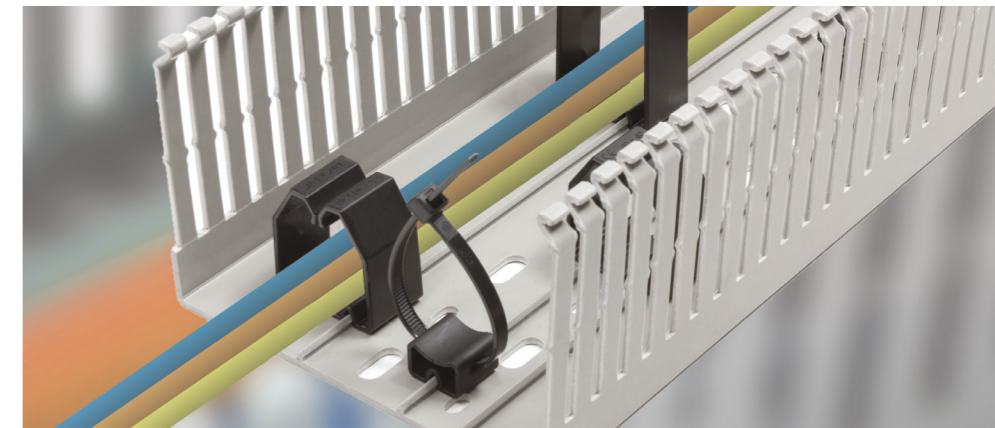

Order No.	Type	Description	Size (mm)									
			A	B	C	D	E	F	G	H	I	J
551 014WS	KKC 4060 - Wide	Wiring Duct	40	56,5	60	12,00	1,60	1,60	13,60	8	12	2,1
551 015WS	KKC 4080 - Wide	Wiring Duct	40	76,8	80	14,00	1,80	1,80	15,80	8	12	2,1
551 032WS	KKC 4010 - Wide	Wiring Duct	40	96,9	100	16,00	1,90	2,00	17,90	8	12	2,1
551 017WS	KKC 6060 - Wide	Wiring Duct	60	56,8	60	12,00	1,80	1,80	13,80	8	12	2,1
551 018WS	KKC 6080 - Wide	Wiring Duct	60	76,7	80	14,00	1,80	1,80	15,80	8	12	2,1
551 033WS	KKC 6010 - Wide	Wiring Duct	60	96,9	100	16,00	2,00	2,00	18,00	8	12	2,1
551 019WS	KKC 8060 - Wide	Wiring Duct	80	57,0	60	12,00	1,80	1,80	13,80	8	12	2,1
551 020WS	KKC 8080 - Wide	Wiring Duct	80	77,1	80	14,00	1,80	1,80	15,80	8	12	2,1
551 035WS	KKC 8010 - Wide	Wiring Duct	80	97,2	100	16,00	2,20	2,20	18,20	8	12	2,1
551 021WS	KKC 1006 - Wide	Wiring Duct	100	57,3	60	12,00	2,00	2,00	14,00	8	12	2,1
551 022WS	KKC 1008 - Wide	Wiring Duct	100	77,2	80	14,00	2,00	2,00	16,00	8	12	2,1
551 036WS	KKC 1001 - Wide	Wiring Duct	100	97,2	100	16,00	2,20	2,30	18,20	8	12	2,1
551 023WS	KKC 1206 - Wide	Wiring Duct	120	57,6	60	12,00	2,30	2,00	14,30	8	12	2,1
551 024WS	KKC 1208 - Wide	Wiring Duct	120	77,5	80	14,00	2,30	2,00	16,30	8	12	2,1
551 025WS	KKC 1201 - Wide	Wiring Duct	120	97,5	100	16,00	2,40	2,40	18,40	8	12	2,1
551 040WS	KKC 1501 - Wide	Wiring Duct	150	98,1	100	16,00	2,70	2,70	18,70	8	12	2,1
540 010	KHF 2530	HF Wiring Duct	25	26,6	30	8,00	1,55	1,55	9,55	4	6	
540 020	KHF 2540	HF Wiring Duct	25	36,8	40	10,00	1,60	1,60	11,60	4	6	
540 030	KHF 2560	HF Wiring Duct	25	56,8	60	12,00	1,60	1,60	13,60	4	6	
540 060	KHF 4040	HF Wiring Duct	40	36,9	40	10,00	1,60	1,60	11,60	4	6	
540 070	KHF 4060	HF Wiring Duct	40	56,9	60	12,00	1,60	1,60	13,60	4	6	
540 080	KHF 4080	HF Wiring Duct	40	76,9	80	14,00	1,80	1,80	15,80	4	6	
540 100	KHF 6040	HF Wiring Duct	60	37,0	40	10,00	1,60	1,60	11,60	4	6	
540 110	KHF 6060	HF Wiring Duct	60	57,1	60	12,00	1,80	1,80	13,80	4	6	
540 120	KHF 6080	HF Wiring Duct	60	77,1	80	14,00	1,90	1,90	15,90	4	6	
540 150	KHF 8060	HF Wiring Duct	80	57,1	60	12,00	1,80	1,80	13,80	4	6	
540 160	KHF 8080	HF Wiring Duct	80	77,1	80	14,00	2,00	2,00	16,00	4	6	



Low Smoke Halogen Free

Top 1,8 - Middle 2,1

Klemsan®

Head Office

Kızılızüm Cad. No:15
Kemalpaşa / İzmir / TURKEY
Tel : +90 232 877 08 00
Fax : +90 232 877 08 06

International Sales Office

Kızılızüm Cad. No:15
Kemalpaşa / İzmir / TURKEY
Tel : +90 232 877 08 00
Fax : +90 232 877 08 06

Domestic Sales Office

Ahi Evran Cad. No:9 Kat:4
Maslak / İstanbul / TURKEY
Tel : +90 212 222 52 00
Fax : +90 212 222 66 55

OVERSEAS OFFICES



Europe

Gsm : +48 51 666 51 41
Mail : ayhankanal@klemsan.com.tr



Russian Federation

PJSC KLEMSAN 127566, 44, Altufevskoe
shosse, Moscow, Russian Federation
Tel : +7 495 720 67 71
Mail : russia@klemsan.ru



Africa & Middle East

Tel : +90 530 401 94 62
Mail : aliabostiet@klemsan.com.tr



GCC & India & Pakistan

Gsm : +90 537 870 11 55
Mail : baranozturk@klemsan.com.tr



Apac & Ocenia

Gsm : +6698 2495282
Mail : rabhasiithchatripoyasayanon@klemsan.com.tr



Ukraine

6-8A, Yaroslava Ivashkevicha str. Office 7-8,
04074, Kiev, UKRAINE
Tel : +380 637 217 185
Mail : tatyanozhko@klemsan.com.tr



Colombia (LATAM)

Gsm : +1 925 315 71 76
Mail : andresastudillo@klemsan.com.tr

Mexico

Gsm : +52 55 1200 01 54
Mail : kellymartinez@klemsan.com.tr



Usa, Canada

Gsm : + 90 538 843 74 51
Mail : baranozturk@klemsan.com.tr



China

Gsm : +90 535 018 49 67
Mail : egecansahin@klemsan.com.tr

