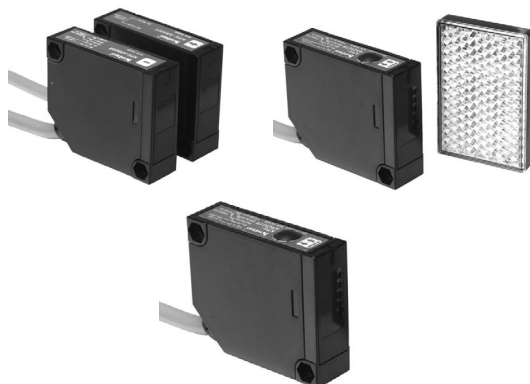

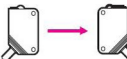
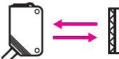

PHOTO SENSORS

KPS-AR SERIES



CLASSIFICATION

KPS - AR

MODEL	Type	Sensing Distance	Protection
500T	Through - beam 	8m	IP64
500R			
250TR	Retro - reflective 	4m	
40DR	Diffuse - reflective 	0.6m	

Wiring diagram

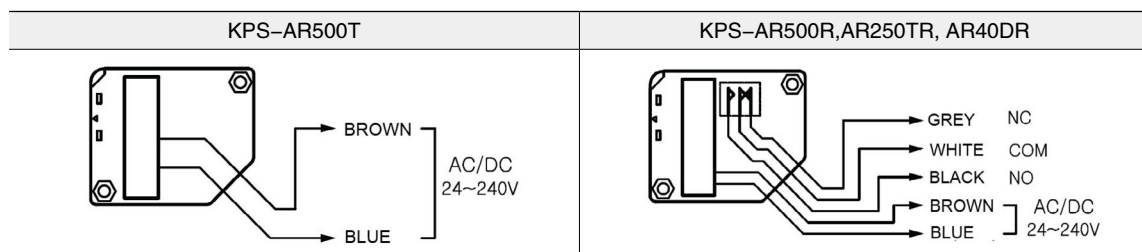

Parallel Operating Range

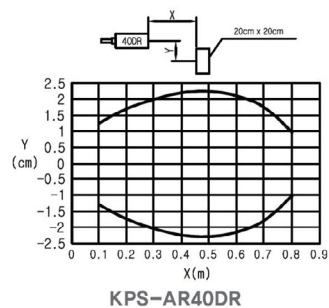
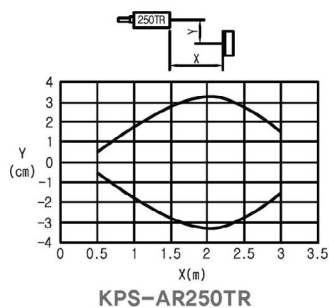
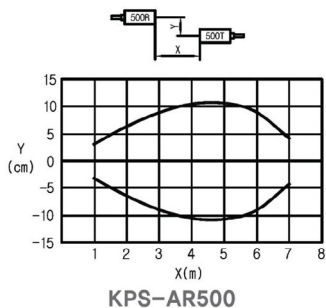

PHOTO SENSORS

Parallel Operating Range

Type	Diffuse Reflective	Retro - reflective	Through - beam	
			Emitter	Receiver
Model	KPS - AR40DR	KPS - AR250TR	KPS - AR500T	KPS - AR500R
Detecting Distance	0.6m Max.	2.5m Max.	5m Max.	
Standard detecting object	Opaque object		Opaque object(Ø16)	
Light Source	Infra - Red LED			
Voltage	AC/DC 24~240V			
Power consumption	Max 2W		Max 1.5W	Max 2W
Output	Relay output: 1C			
Contact ratings	30VDC 2A, 125VAC 0.6A			
Response time	20ms Max.			
External light interference	incandescent light 3,000 lx, sun light 10,000 lx Max.			
Ambient temperature	- 20~+60			
Ambient humidity	35~85%RH			
Insulation resistance	min. 20M			
Dielectric strength	2,000VAC 50/60Hz for 1 minute			
Vibration resistance	10~55Hz at double amplitude: 1.5mm(X,Y,Z directions) for 1 hour			
Shock resistance	10G			
Protection	IP50			
Indicator	Red LED			
Weight	107 g			
Cable	Ø6.1, 1.5m wire			
Material	ABS			

Dimensions

KPS - AR SERIES

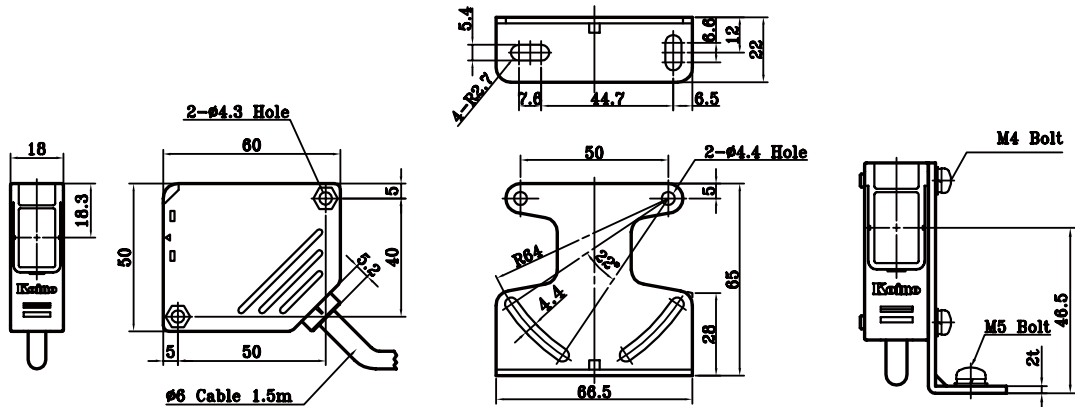
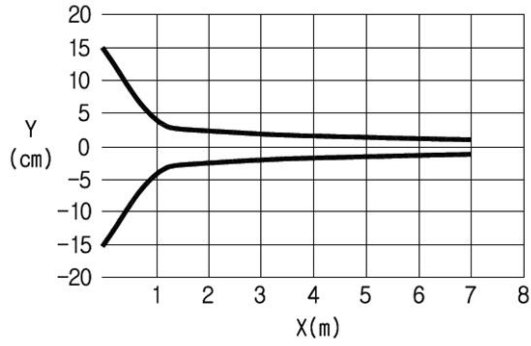

PHOTO SENSORS

Angle characteristic

KPS - AR500



KPS - AR250TR

