

ø22 LW Series Switches & Pilot Lights

Light touch mechanism designed to reduce strain injuries
Endures repetitive operation suitable for food processing and packaging industries

- Light touch
- Collective mounting is possible.
- Locking lever removable contact blocks enables easy installation even when mounted collectively.
- Gold plated silver or silver contacts.
- Degree of protection: IP65 (IEC 60529) (except buzzer)
- UL recognized and CSA certified. EN compliant. (except buzzers)



Specifications and Ratings

Contact Ratings

Gold Contact

Rated Insulation Voltage	250V		
Thermal Current	3A		
Operating Voltage	125V AC	30V DC	
Operating Current (resistive load)	0.1A	0.1A	
Contact Material	Gold plated silver		

Minimum applicable load (reference value): 5V AC/DC, 1mA
 (Applicable range is subject to the operating condition and load.)

Silver Contact

Rated Insulation Voltage		250V				
Rated Operating Voltage		30V	125V	250V		
Rated Operating Current	AC 50/60Hz	Resistive load	—	3A	2A	
		Inductive load	—	2A	1.5A	
	DC	Resistive load	2A	0.4A	—	
		Inductive load	1A	0.2A	—	
Rated Thermal Current		5A				
Contact Material		Silver				

• AC inductive load: PF=0.6 to 0.7 DC inductive load: L/R=7 ms max.

Specifications

Operating Temperature	-25 to +60°C (no freezing) Illuminated units: -25 to +50°C	
Storage Temperature	-40 to +80°C (no freezing)	
Operating Humidity	45 to 85% RH (no condensation)	
Contact Resistance	50 mΩ maximum (initial value)	
Insulation Resistance	100 MΩ minimum (500V DC megger)	
Dielectric Strength	Switch Unit	Between live part and ground: 2,500V AC, 1 minute Between terminals of different poles: 2,500V AC, 1 minute Between terminals of the same pole: 1,000V AC, 1 minute
	Illumination Unit	Between live part and ground: 2,500V AC, 1 minute
Vibration Resistance	Damage Limits, Operating extremes: 5 to 55 Hz, amplitude 0.5 mm	
Shock Resistance	Damage limits: 1,000 m/s ² Operating extremes: 100 m/s ²	
Mechanical Life (minimum operations)	Momentary:	1,000,000
	Maintained:	500,000
	Selector switches:	250,000
	Key selector switches:	250,000
	Illuminated selector switches:	250,000
Electrical Life (minimum operations)	Momentary:	100,000 (switching frequency 1800 operations/h)
	Maintained:	100,000 (switching frequency 900 operations/h)
	Selector switches:	100,000 (switching frequency 900 operations/h)
Degree of Protection	IP65 (IEC 60529) (except buzzer)	
Terminal Style	Solder/tab terminal no. 110 PC board terminal Screw terminal	
Weight (approx.)	10g (LW1B-M1C3) 15g (LW1P-14) 24g (LW1L-M1C34) 24g (LW1S-2C3) 39g (LW1K-2C3A) 27g (LW1F-2C34)	

LED Lamp Ratings (LSTD)

Part No.	LSTD-6②	LSTD-1②	LSTD-2②
Lamp Base	BA9S/13		
Rated Voltage	6V AC/DC	12V AC/DC	24V AC/DC
Voltage Range	6V AC/DC ±10%	12V AC/DC ±10%	24V AC/DC ±10%
Current Draw	AC	8 mA (A, G, PW, R), 7 mA (S)	11 mA (A, G, PW, R), 9 mA (S)
	DC	7 mA (A, R), 5.5 mA (G, PW), 4.5 mA (S)	10 mA (A, G, PW, R), 8 mA (S)
Color Code ②	A (amber), G (green), PW (pure white), R (red), S (blue)		
Lamp Base Color	Same as illumination color		
Voltage Marking	Die stamped on the base		
Life (reference value)	Approx. 50,000 hours (The luminance is reduced to 50% the initial intensity when used on complete DC.)		
Internal Circuit			

Mounting Hole Layout

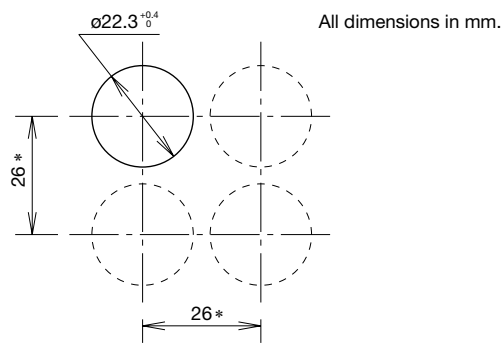

Note: Determine the mounting centers to ensure easy operation.

- ø30mm Mushroom: Vertical: 32 mm minimum
Horizontal: 32 mm minimum
- Solder/Tab Terminal
 - Without terminal cover: Vertical: 26 mm minimum
Horizontal: 26 mm minimum
 - With terminal cover: Vertical: 26 mm minimum
Horizontal: 27 mm minimum
- Screw terminal: Vertical: 40 mm minimum
Horizontal: 26 mm minimum
- PC board terminal: Vertical: 26 mm minimum
Horizontal: 26 mm minimum



Ordering Information

Standard Units

- Specify a button or lens color code in the Part No.
- All illuminated units are supplied with an LED lamp.
- All standard units are UL recognized, CSA certified, and EN compliant (TÜV Rheinland).

Pilot Lights

Package Quantity: 1

Shape	Operating Voltage	Part No			② Color Code
		Solder/Tab Terminal (Unibody)	PC Board Terminal (Removable Contact Block)	Screw Terminal (Unibody)	
Round Flush LW1P 	6V AC/DC±10%	LW1P-12②	LW1P-1C02V②	LW1P-12M②	Specify a color code in place of ② in the Part No. A: amber G: green PW: pure white R: red S: blue Y: yellow
	12V AC/DC±10%	LW1P-13②	LW1P-1C03V②	LW1P-13M②	
	24V AC/DC±10%	LW1P-14②	LW1P-1C04V②	LW1P-14M②	
Square Flush LW2P 	6V AC/DC±10%	LW2P-12②	LW2P-1C02V②	LW2P-12M②	
	12V AC/DC±10%	LW2P-13②	LW2P-1C03V②	LW2P-13M②	
	24V AC/DC±10%	LW2P-14②	LW2P-1C04V②	LW2P-14M②	
Round Flush with Square Bezel LW3P 	6V AC/DC±10%	LW3P-12②	LW3P-1C02V②	LW3P-12M②	
	12V AC/DC±10%	LW3P-13②	LW3P-1C03V②	LW3P-13M②	
	24V AC/DC±10%	LW3P-14②	LW3P-1C04V②	LW3P-14M②	

- Every pilot light is supplied with an LED lamp (LSTD) of the specified color and voltage.
- A pure white LED lamp is used for yellow illumination.
- For marking plate and film, see page 27.

Dimensions

All dimensions in mm.

Unibody

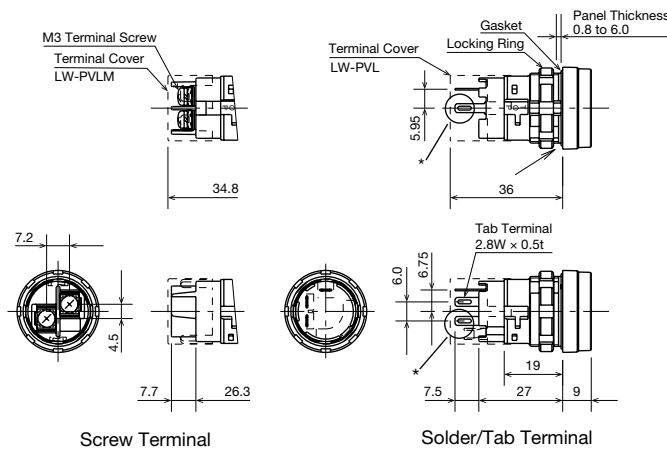

Removable Contact Block

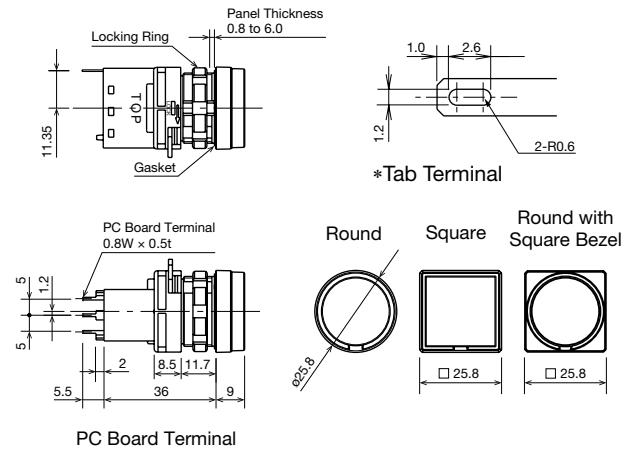

Terminal Arrangement

Unibody

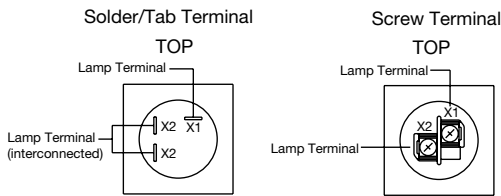

- Lamp terminals do not have any polarity.

Removable Contact Block

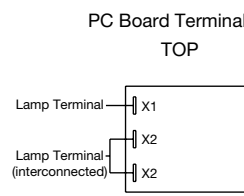

- Lamp terminals do not have any polarity.





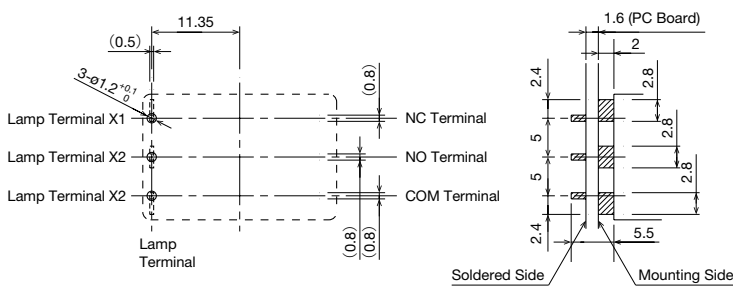



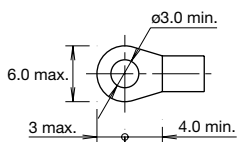

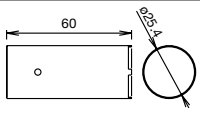



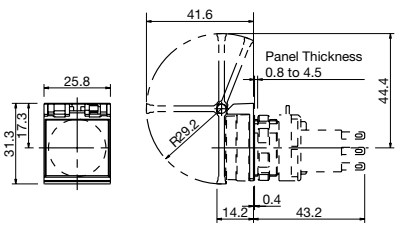

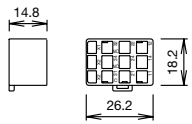
PC Board Drilling Layout (Bottom View)

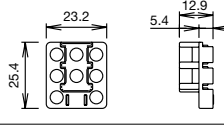

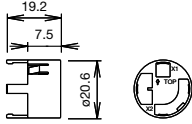

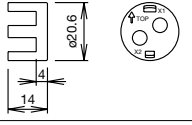
Pay attention to the pattern of the PC board as the terminals on the mounting surface are 2.8 mm wide.

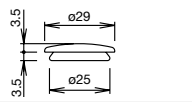

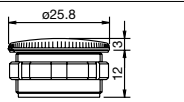











Applicable Crimping Terminal



Accessories					
Shape	Material	Part No.	Package Quantity	Dimensions (mm)	
	Nickel-plated brass	LW9Z-T1	1	<ul style="list-style-type: none"> Used to tighten the locking ring when installing the LW switch onto a panel. Tightening torque: 1.2 N·m 	
	Rubber	OR-55	1	<ul style="list-style-type: none"> Used to install and remove LED lamps. 	
	Spring Return Maintained Guard (polyarylate) Base (polyacetal)	LW9Z-K1	1	<ul style="list-style-type: none"> Used to protect flush pushbuttons and illuminated pushbuttons from inadvertent operation. Degree of protection: IP65.  <p>Note: Determine mounting centers to ensure easy operation.</p>	
		LW9Z-K11	1		
	Plastic (translucent)	LW-VL2	1	<ul style="list-style-type: none"> For units with removable contacts only. 	
	Plastic (black)	LW-VL2M	1	<ul style="list-style-type: none"> For units with removable contacts only. 	
	Plastic (translucent)	LW-PVL	1	<ul style="list-style-type: none"> For unibody pilot lights only. 	
	Plastic (translucent)	LW-PVLM	1	<ul style="list-style-type: none"> For unibody pilot lights only. 	
	Nitril rubber (black)	OB-31PN05	5	<ul style="list-style-type: none"> Degree of protection: IP65 	
	Metal (diecast) Locking nut (plastic)	LW9Z-BM	1	<ul style="list-style-type: none"> Degree of protection: IP66 Panel thickness: 0.8 to 6 mm 	

Maintenance Parts						
Shape	For Use On	Material	Part No.	Ordering No.	Package Quantity	Color Code
	Round Flush	Polyarylate	LW9Z-L1②	LW9Z-L1②PN05	5	Specify a lens color code in place of ② in the Ordering No.
	Round Flush with Square Bezel					
	Round Extended	Polyarylate	LW9Z-L12②	LW9Z-L12②PN05	5	A: amber C: clear G: green R: red S: blue Y: yellow
	Square Flush	Polyarylate	LW9Z-L2②	LW9Z-L2②PN05	5	
	ø30mm Mushroom	AS	LW9Z-L13②	LW9Z-L13②	1	<ul style="list-style-type: none"> Use a clear (C) lens for pure white and white illumination.

Maintenance Parts

Shape	For Use On	Material	Part No.	Ordering No.	Package Quantity	Color Code	
	Round Flush	Polyacetal	LW1A-B1①	LW1A-B1①PN05	5	Specify a button color code in place of ① in the Ordering No. B: black G: green R: red S: blue W: white Y: yellow	
	Round Flush with Square Bezel						
	Extended	Polyacetal	LW1A-B2①	LW1A-B2①PN05	5		
	Round Extended with Square Bezel						
	Square Flush	Polyacetal	LW2A-B1①	LW2A-B1①PN05	5		
	Square Extended	Polyacetal	LW2A-B2①	LW2A-B2①PN05	5		
	ø30mm Mushroom	AS	LW1A-B3①	LW1A-B3①	1		
	Round	Acryl	LW9Z-P1W	LW9Z-P1WPN05	5		• White
	Round with Square Bezel						
	Square	Acryl	LW9Z-P2W	LW9Z-P2WPN05	5		
	Round Extended	Acryl	LW9Z-P12W	LW9Z-P12WPN05	5		
	Mushroom	Acryl	ALW3B	ALW3BPN05	5		
	Illuminated Selector	Plastic	LW1A-F②	LW1A-F②	1	A (amber), G (green), R (red), S (blue), W (white), Y (yellow)	
	All LW units	Plastic	LW9Z-LN	LW9Z-LNPN05	5	• Black	
	Selector Switch	Stainless Steel	LW9Z-L	LW9Z-LPN10	10		
	Key Selector Switch	Metal	KG9Z-SK-231	KG9Z-SK-231PN02	2		

LED Lamps

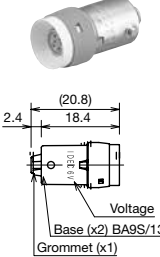
Dimensions	Operating Voltage	Current Draw		Part No.	Ordering No.	Illumination Color Code	Package Quantity	Base		
		AC	DC							
 <p> (20.8) 18.4 2.4 Voltage Base (x2) BA9S/13 Grommet (x1) </p>	6V AC/DC ±10%	8 mA (except S) 7 mA (S)	7 mA (A, R, W)	LSTD-6②	LSTD-6②	Specify a color code in place of ② in the Ordering No. A: amber G: green PW: pure white R: red S: blue	1	BA9S/13		
			5.5 mA (G, PW) 4.5 mA (S)		LSTD-6②PN10		10			
		12V AC/DC ±10%	11 mA (except S) 9 mA (S)	10 mA (except S)	LSTD-1②		LSTD-1②		1	
				8 mA (S)			LSTD-1②PN10		10	
		24V AC/DC ±10%	11 mA (except S) 9 mA (S)	10 mA (except S)	LSTD-2②		LSTD-2②		Use a pure white (PW) LED lamp with (Y) lens.	1
				8 mA (S)			LSTD-2②PN10			10

Transformer

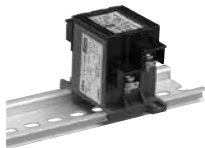
Shape	Primary Voltage	Secondary Voltage	Part No.	Applicable Load
Din Rail Mount Transformer For 6V 	100/110V AC	5.5V AC, 1W	TWR516	LSTD-6 LED lamp (6V AC/DC) or LS-6 incandescent lamp (6V AC/DC, 1W)
	115/120V AC		TWR5126	
	200/220V AC		TWR526	
	230/240V AC		TWR5246	
	380V AC		TWR5386	
	400/440V AC		TWR546	
	480V AC		TWR5486	

Specifications

Operating Voltage	100/110V AC, 115/120V AC, 200/220V AC, 230/240V AC, 380V AC, 400/440V AC, 480V AC (50/60Hz)
Current Draw	2.4 VA
Rated Insulation Voltage	600V
Insulation Resistance	100 MΩ minimum (500V DC megger)
Operating Temperature	-30 to +60°C (no freezing)
Storage Temperature	-40 to +80°C (no freezing)
Operating Humidity	35 to 85% RH (no condensation)
Vibration Resistance	Damage Limits: 30 Hz, amplitude 1.5 mm Operating extremes: 5 to 55 Hz, amplitude 0.5 mm
Shock Resistance	Damage limits, Operating Extremes: 1,000 m/s ²
Dielectric Strength	2,500V AC, 1 minute
Terminal Screw	M3.5
Applicable Wire	2 mm ² maximum, 2 wires maximum
Weight (approx.)	87g

Dimensions

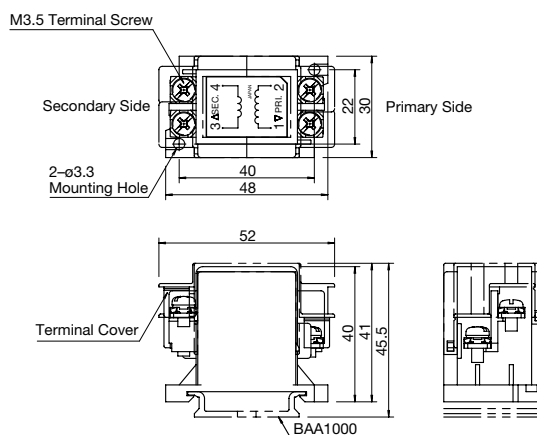

Accessories

DIN Rail

Part No.	Ordering No.	Length	Weight (approx.)	Material	Package Quantity
BAA1000	BAA1000PN10	1000 mm	200g	Aluminum	10

End Clip

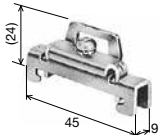
Part No.	Ordering No.	Applicable DIN Rail	Weight (approx.)	Material	Package Quantity	Dimensions
BNL6	BNL6PN10	BAA1000 BAP1000	15g	Steel (Zinc-plated)	10	

Safety Precautions

- Turn off the power to the LW series before starting installation, removal, wiring, maintenance, and inspection of the products. Failure to turn power off may cause electrical shocks or fire hazard.
- To avoid burning your hand, use the lamp holder tool when replacing lamps.
- For wiring, use wires of a proper size to meet the voltage and current requirements. Solder correctly according to the instructions on “Wiring” and “Notes on Terminal Cover” on page 28. Tighten the M3 terminal screws to a torque of 0.6 to 1.0 N·m. Failure to tighten terminal screws may cause overheating and fire.

Instructions

Panel Mounting

Remove the contact block from the operator. Insert the operator into the panel cut-out from the front, then install the contact block.

Removing the Contact Block

Turn the locking lever on the contact block in the direction opposite to the arrow on the housing. Then the contact can be removed.

Installing the Contact Block

Insert the contact block, with the TOP markings on the contact block and the operator placed in the same direction. Then lock the units, turning the locking lever in the direction of the arrow.

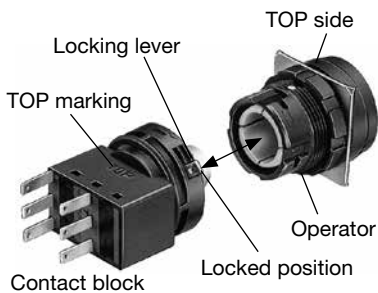

Notes on Mounting

Use the optional ring wrench (LW9Z-T1) to mount the operator onto the panel. Tightening torque should not exceed 1.2 N·m. Do not use pliers. Excessive tightening will damage the locking ring.

Collective Mounting

As the locking lever can be turned easily from the rear of the units using a screwdriver, the contact blocks can be removed even when mounted collectively.

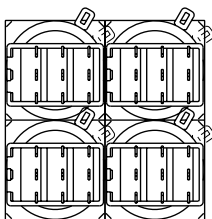

Replacement of Lens and Marking Plate

Removing

1. Remove the operator (lens, marking plate, and lens holder) by inserting a screwdriver into the recess of the lens through the bezel.

[Removing the Operator]



2. Remove the marking plate by pushing the lens from the rear to disengage the latches between the lens and the lens holder, using the screwdriver as shown below.

[Removing the lens]



Note: The translucent filter in the lens holder cannot be removed because the filter is sealed to make the unit waterproof.

Installing

For round lens, place the marking plate on the lens holder with the anti-rotation projection engaged and press the lens onto the lens holder to engage the latches. For square lens, insert the marking plate into the lens, and press the lens onto the holder to engage the latches.

Note: Make sure of correct orientation of the marking plate.

[Round Lens]

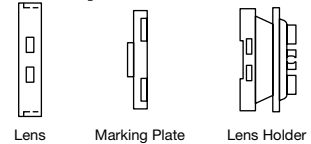

[Square Lens]

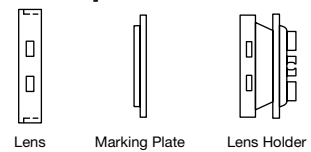

Marking Plate and Films

For LW series illuminated pushbuttons and pilot lights, legends and symbols can be engraved on the marking plates, or printed marking film can be inserted under the lens for labelling purposes.

Marking Plate and Marking Film Size

Lens	Round Lens	Square Lens
Built-in Marking Plate		
	<ul style="list-style-type: none"> • Engraving must be made on the engraving area within 0.5mm deep. • The marking plate is made of white acrylic resin. 	
Applicable Marking Film		
	<ul style="list-style-type: none"> • Two 0.1mm-thick films or one 0.2mm-thick film can be installed in the lens. • Marking film is not included. • Recommended marking film: Polyester film 	

Instructions

Insertion Order of Marking Plate and Film

[Round Lens]

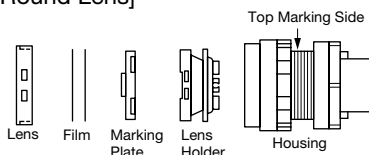

Note: Film is not included

[Square Lens]

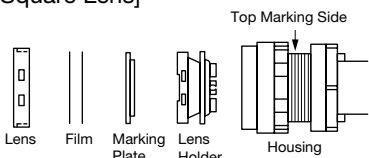

Note: Film is not included

Make sure of correct orientation of the marking plate.

Replacement of Lamps

Lamps can be replaced using the lamp holder tool (OR-55) from the front of the panel, or by removing the contact block from the operator.

How to Remove

To remove, slip the lamp holder tool onto the lamp head. Then push slightly, and turn the lamp holder tool counterclockwise.



Lamp Holder Tool
OR-55



How to Install

1. To install, insert the lamp head into the lamp holder tool, and hold the lamp as shown in the figure below.

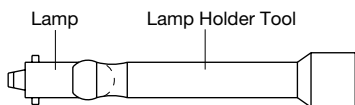

2. Insert the pins on the lamp base into the grooves in the lamp socket. Insert the lamp and turn it clockwise.

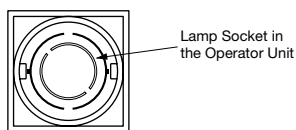

Wiring

1. Solder the terminals within 20W/5 sec or 260°C/3 sec without exerting external force to the terminals. While soldering, do not touch the soldering iron to the housing. While wiring, prevent tension from being applied to the terminals. Do not bend or raise the terminals, nor exert excessive force to terminals.
2. Use non-corrosive liquid flux.
3. For tab terminals, Positive Lock Connectors and Easy Lock Connectors can be used.
4. Tighten the terminal screw of the screw terminal type to a torque of 0.6 to 1.0 N·m.

Notes on Terminal Cover

[Solder/Tab Terminal]

Insert the terminal cover into the contact block with the TOP markings on the contact block and the terminal cover in the same direction.

Note: When wiring, insert the lead wires into the terminal cover holes before soldering.



Notes on Wiring

When installing a terminal cover onto the solder/tab terminal contact block, solder the inside of lamp terminal (toward the switch terminals) and wire.

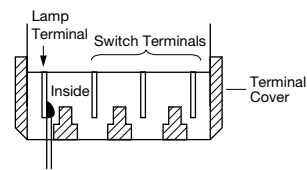

[Screw Terminal]

Terminal cover must be installed on the LW series before wiring.

Note 1: After wiring, terminal covers cannot be installed.

Note 2: When terminal covers are installed, do not use round crimping terminals.

(Wire the terminal by using fork terminals or lead wires directly.)

Single Board Mounting



Mounting the LW series unit on a single PC board offers the following features.

1. Reduced installation labor, easy wiring, space saving, and standardization.
2. Since the contact blocks on the PC board can be removed easily using a locking lever, LW series is easy to maintain.
3. Because the LW series requires no studs for fastening the unit to a PC board, special preparation of operation panel is not needed.
4. For details on single board mounting, contact IDEC.

Ordering Terms and Conditions

Thank you for using IDEC Products.

By purchasing products listed in our catalogs, datasheets, and the like (hereinafter referred to as "Catalogs") you agree to be bound by these terms and conditions. Please read and agree to the terms and conditions before placing your order.

1. Notes on contents of Catalogs

- (1) Rated values, performance values, and specification values of IDEC products listed in this Catalog are values acquired under respective conditions in independent testing, and do not guarantee values gained in combined conditions.
Also, durability varies depending on the usage environment and usage conditions.
- (2) Reference data and reference values listed in Catalogs are for reference purposes only, and do not guarantee that the product will always operate appropriately in that range.
- (3) The specifications / appearance and accessories of IDEC products listed in Catalogs are subject to change or termination of sales without notice, for improvement or other reasons.
- (4) The content of Catalogs is subject to change without notice.

2. Note on applications

- (1) If using IDEC products in combination with other products, confirm the applicable laws / regulations and standards.
Also, confirm that IDEC products are compatible with your systems, machines, devices, and the like by using under the actual conditions. IDEC shall bear no liability whatsoever regarding the compatibility with IDEC products.
- (2) The usage examples and application examples listed in Catalogs are for reference purposes only. Therefore, when introducing a product, confirm the performance and safety of the instruments, devices, and the like before use. Furthermore, regarding these examples, IDEC does not grant license to use IDEC products to you, and IDEC offers no warranties regarding the ownership of intellectual property rights or non-infringement upon the intellectual property rights of third parties.
- (3) When using IDEC products, be cautious when implementing the following.
 - i. Use of IDEC products with sufficient allowance for rating and performance
 - ii. Safety design, including redundant design and malfunction prevention design that prevents other danger and damage even in the event that an IDEC product fails
 - iii. Wiring and installation that ensures the IDEC product used in your system, machine, device, or the like can perform and function according to its specifications
- (4) Continuing to use an IDEC product even after the performance has deteriorated can result in abnormal heat, smoke, fires, and the like due to insulation deterioration or the like. Perform periodic maintenance for IDEC products and the systems, machines, devices, and the like in which they are used.
- (5) IDEC products are developed and manufactured as general-purpose products for general industrial products. They are not intended for use in the following applications, and in the event that you use an IDEC product for these applications, unless otherwise agreed upon between you and IDEC, IDEC shall provide no guarantees whatsoever regarding IDEC products.
 - i. Use in applications that require a high degree of safety, including nuclear power control equipment, transportation equipment (railroads / airplanes / ships / vehicles / vehicle instruments, etc.), equipment for use in outer space, elevating equipment, medical instruments, safety devices, or any other equipment, instruments, or the like that could endanger life or human health
 - ii. Use in applications that require a high degree of reliability, such as provision systems for gas / waterworks / electricity, etc., systems that operate continuously for 24 hours, and settlement systems
 - iii. Use in applications where the product may be handled or used deviating from the specifications or conditions / environment listed in the Catalogs, such as equipment used outdoors or applications in environments subject to chemical pollution or electromagnetic interference
If you would like to use IDEC products in the above applications, be sure to consult with an IDEC sales representative.

3. Inspections

We ask that you implement inspections for IDEC products you purchase without delay, as well as thoroughly keep in mind management/maintenance regarding handling of the product before and during the inspection.

4. Warranty

- (1) Warranty period
The warranty period for IDEC products shall be one (1) year after purchase or delivery to the specified location. However, this shall not apply in cases where there is a different specification in the Catalogs or there is another agreement in place between you and IDEC.
- (2) Warranty scope
Should a failure occur in an IDEC product during the above warranty period for reasons attributable to IDEC, then IDEC shall replace or repair that product, free of charge, at the purchase location / delivery location of the product, or an IDEC service base. However, failures caused by the following reasons shall be deemed outside the scope of this warranty.
 - i. The product was handled or used deviating from the conditions / environment listed in the Catalogs
 - ii. The failure was caused by reasons other than an IDEC product
 - iii. Modification or repair was performed by a party other than IDEC
 - iv. The failure was caused by a software program of a party other than IDEC
 - v. The product was used outside of its original purpose
 - vi. Replacement of maintenance parts, installation of accessories, or the like was not performed properly in accordance with the user's manual and Catalogs
 - vii. The failure could not have been predicted with the scientific and technical standards at the time when the product was shipped from IDEC
 - viii. The failure was due to other causes not attributable to IDEC (including cases of force majeure such as natural disasters and other disasters)Furthermore, the warranty described here refers to a warranty on the IDEC product as a unit, and damages induced by the failure of an IDEC product are excluded from this warranty.

5. Limitation of liability

The warranty listed in this Agreement is the full and complete warranty for IDEC products, and IDEC shall bear no liability whatsoever regarding special damages, indirect damages, incidental damages, or passive damages that occurred due to an IDEC product.

6. Service scope

The prices of IDEC products do not include the cost of services, such as dispatching technicians. Therefore, separate fees are required in the following cases.

- (1) Instructions for installation / adjustment and accompaniment at test operation (including creating application software and testing operation, etc.)
- (2) Maintenance inspections, adjustments, and repairs
- (3) Technical instructions and technical training
- (4) Product tests or inspections specified by you

The above content assumes transactions and usage within your region. Please consult with an IDEC sales representative regarding transactions and usage outside of your region. Also, IDEC provides no guarantees whatsoever regarding IDEC products sold outside your region.

IDEC CORPORATION

Head Office

6-64, Nishi-Miyahara-2-Chome, Yodogawa-ku, Osaka 532-0004, Japan

USA	IDEC Corporation	Tel: +1-408-747-0550	opencontact@idec.com
Germany	APEM GmbH	Tel: +49-40-25 30 54-0	service@eu.idec.com
Singapore	IDEC Izumi Asia Pte. Ltd.	Tel: +65-6746-1155	info@sg.idec.com
Thailand	IDEC Asia (Thailand) Co., Ltd	Tel: +66-2-392-9765	sales@th.idec.com
India	IDEC Controls India Private Limited	Tel: +91-80679-35328	info_india@idec.com
Taiwan	IDEC Taiwan Corporation	Tel: +886-2-2577-6938	service@tw.idec.com

Hong Kong	IDEC Izumi (H.K.) Co., Ltd.	Tel: +852-2803-8989	info@hk.idec.com
China	IDEC (Shanghai) Corporation	Tel: +86-21-6135-1515	idec@cn.idec.com
	Beijing Branch	Tel: +86-10-6581-6131	idec@cn.idec.com
	Guangzhou Branch	Tel: +86-20-8362-2394	idec@cn.idec.com
Japan	IDEC Corporation	Tel: +81-6-6398-2527	jp_marketing@idec.com

 www.idec.com

Specifications and other descriptions in this brochure are subject to change without notice.

