

Indicator / Thumbwheel Switch Panel Meters



M4W Series CATALOG MANUAL

For your safety, read and follow the considerations written in the instruction manual, other manuals and Autonics website.

The specifications, dimensions, etc. are subject to change without notice for product improvement. Some models may be discontinued without notice.

Features

- Max. display value: 1999
- Auto-zero function and hold display value function
- Linear display based on input specification
- Display output values (0 - 10 VDC \Rightarrow) from power converters (options available for DC 4 - 20 mA, 1 - 5 VDC \Rightarrow)
- RMS or AVG value selection (AC voltage)
- 7-segment LED display
- DIN standard size models

Safety Considerations

- Observe all 'Safety Considerations' for safe and proper operation to avoid hazards.
- Δ symbol indicates caution due to special circumstances in which hazards may occur.

Δ Warning Failure to follow instructions may result in serious injury or death.

- 01. Fail-safe device must be installed when using the unit with machinery that may cause serious injury or substantial economic loss. (e.g. nuclear power control, medical equipment, ships, vehicles, railways, aircraft, combustion apparatus, safety equipment, crime / disaster prevention devices, etc.)**
Failure to follow this instruction may result in personal injury, economic loss or fire.
- 02. Do not use the unit in the place where flammable / explosive / corrosive gas, high humidity, direct sunlight, radiant heat, vibration, impact or salinity may be present.**
Failure to follow this instruction may result in explosion or fire.
- 03. Install on a device panel to use.**
Failure to follow this instruction may result in fire or electric shock.
- 04. Do not connect, repair, or inspect the unit while connected to a power source.**
Failure to follow this instruction may result in fire or electric shock.
- 05. Check 'Connections' before wiring.**
Failure to follow this instruction may result in fire.
- 06. Do not disassemble or modify the unit.**
Failure to follow this instruction may result in fire or electric shock.

Δ Caution Failure to follow instructions may result in injury or product damage.

- 01. When connecting the power / measurement input and relay output, use AWG 24 (0.20 mm²) to AWG 15 (1.65 mm²) cable or over and tighten the terminal screw with a tightening torque of 0.98 to 1.18 N m. Use the wiring suitable for the load current capacity.**
Failure to follow this instruction may result in fire or malfunction due to contact failure.
- 02. Use the unit within the rated specifications.**
Failure to follow this instruction may result in fire or product damage.
- 03. Use a dry cloth to clean the unit, and do not use water or organic solvent.**
Failure to follow this instruction may result in fire or electric shock.
- 04. Keep the product away from metal chip, dust, and wire residue which flow into the unit.**
Failure to follow this instruction may result in fire or product damage.

Cautions during Use

- Follow instructions in 'Cautions during Use'. Otherwise, It may cause unexpected accidents.
- Install a power switch or circuit breaker in the easily accessible place for supplying or disconnecting the power.
- Keep away from high voltage lines or power lines to prevent inductive noise. In case installing power line and input signal line closely, use line filter or varistor at power line and shielded wire at input signal line. Do not use near the equipment which generates strong magnetic force or high frequency noise.

Connection with the line filter

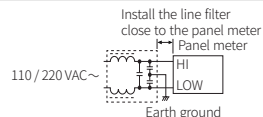

Connection with the varistor

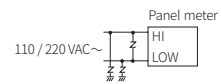

- This unit may be used in the following environments.
 - Indoors (in the environment condition rated in 'Specifications')
 - Altitude max. 2,000 m
 - Pollution degree 2
 - Installation category II

Ordering Information

This is only for reference, the actual product does not support all combinations. For selecting the specified model, follow the Autonics website.

M 4 W ① - ② ③ - ④

① Output

No mark: Indicator
1P: Single setting
2P: Dual setting

② Input type

DV: DC voltage
AV: AC voltage
DA: DC current
AA: AC current
W: Power
T: Rotation
S: Speed
DI: Scaling (DC 4 - 20 mA)

③ AC measurement method

No mark: AVG
R: RMS

④ Measurement input

Refer to measurement input specifications.

Measurement Input Specifications

Measurement input	Input type							
	DV	AV	DA	AA	W ⁰¹⁾	T ⁰²⁾	S ⁰²⁾	DI
No mark	-	-	-	-	-	-	-	1999
1	199.9 mVDC≐	199.9 mVAC~	199.9 μA	19.99 mA	199.9 W	1999 rpm 0 - 10 VDC≐	1999 m/min 0 - 10 VDC≐	-
2	1.999 VDC≐	1.999 VAC~	1.999 mA	19.99 mA	1.999 kW	1999 rpm 0 - 10 VAC~	1999 m/min 0 - 10 VAC~	-
3	19.99 VDC≐	19.99 VAC~	19.99 mA	1.999 A	19.99 kW	-	-	-
4	199.9 VDC≐	199.9 VAC~	199.9 mA	19.99 A	199.9 kW	-	-	-
5	300 VDC≐	-	1.999 A	19.99 A	-	-	-	-
6	-	400 VAC~	19.99 A	19.99 A	-	-	-	-
7	-	-	199.9 A	-	-	-	-	-
8	-	-	1999 A	-	-	-	-	-
DX	-	-	-	-	-	-	-	DC input option
AX	-	-	-	-	-	-	-	AC input option
XX	Option	Option	Option	Option	Option	-	-	Option

01) This specification is based on the transducer with 0 - 10 VDC≐ output.

When the output of transducer is DC 4 - 20 mA or 1 - 5 VDC≐, use the scaling meter.

02) This specification is based on the tachogenerator with 0 - 10 VDC≐ or 0 - 10 VAC~ output.

Product Components

• Product (+ bracket)

• Instruction manual

Dimensions

- Unit: mm, For the detailed drawings, follow the Autonics website.
- Following items are based on single setting model.

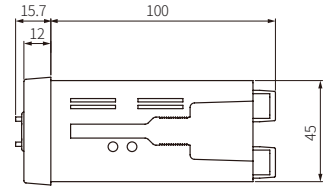
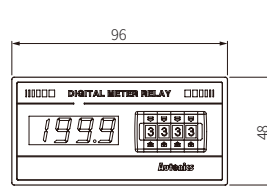

■ Bracket

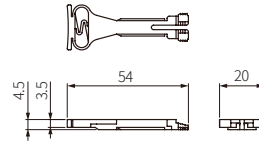

■ Panel cut-out

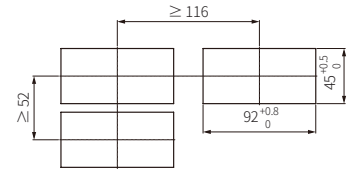

Cautions during Wiring

- Unit: mm, Use terminals of size specified below.

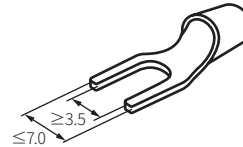

Connections

■ Indicator

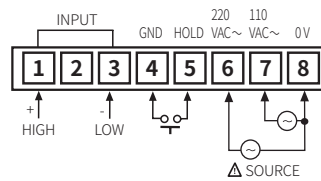

■ Single setting

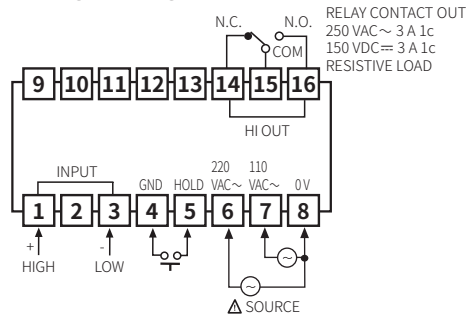

■ Dual setting

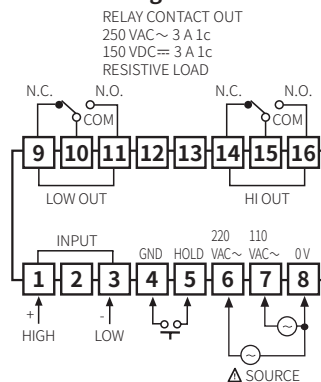

• Power option



Specifications

Input type	DC voltage	AC voltage	DC current	AC current	Power	Rotation, speed	Scaling
Max. allowable input	≤ 300 VDC≐	≤ 400 VAC~	≤ DC 2 A	≤ AC 5 A	≤ 10 VDC≐	≤ 10 VDC≐	DC 4 - 20 mA
	≈ 150 % F.S. for each measured input range ⁰¹⁾						
Display method	7-segment (red) LED (character height: 14 mm)						
Display accuracy	Dependent on the input type						
DC input	± 0.2 % F.S. rdg ± 1-digit					± 0.3 % F.S. rdg ± 1-digit	
AC input	± 0.5 % F.S. rdg ± 1-digit						
Display scale	1999						
Sampling time	2.5 times / sec						
Response speed	≈ 2 sec (0 to 1999)						
Sampling cycle	300 ms						
Operation method	Dual integral method						
Unit weight	Dependent on the output type						
Indicator	≈ 168 g						
Single setting	≈ 253 g						
Dual setting	≈ 278 g						
Approval	EUL						

01) At 400 VAC~ input: ≈ 120 % F.S. for each measured input range

Output type	Indicator	Single setting	Dual setting
Power supply ⁰¹⁾	110 / 220 VAC~ ± 10 % 50 / 60 Hz		
Power consumption	Dependent on the input type		
DC input	2 W	3 W	3 W
AC input	4 VA	5 VA	5 VA
Contact capacity	-	250 VAC~ 3 A, 150 VDC≐ 3 A	250 VAC~ 3 A, 150 VDC≐ 3 A
Contact composition	-	1c × 1	1c × 2
Insulation resistance	≥ 100 MΩ (500 VDC≐ megger)		
Dielectric strength	2,000 VAC~ 50 / 60 Hz for 1 min		
Noise immunity	± 1 kV square wave noise (pulse width: 1 μs) by the noise simulator		
Vibration	0.75 mm double amplitude at frequency of 10 to 55 Hz (for 1 minute) in each X, Y, Z direction for 1 hours		
Vibration (malfunction)	0.5 mm double amplitude at frequency of 10 to 55 Hz (for 1 minute) in each X, Y, Z direction for 10 min		
Shock	300 m/s ² (≈ 30 G) in each X, Y, Z direction for 3 times		
Shock (malfunction)	100 m/s ² (≈ 10 G) in each X, Y, Z direction for 3 times		
Relay life cycle	Mechanical: ≥ 10,000,000 operations Electrical: ≥ 100,000 operations (250 VAC~ 3A resistive load)		
Ambient temperature	-10 to 50 °C, storage: -25 to 65 °C (no freezing or condensation)		
Ambient humidity	35 to 85 %RH, storage: 35 to 85 %RH (no freezing or condensation)		

01) Power supply 24 - 70 VDC≐, 100 - 240 VAC~ 50 / 60 Hz options are also available to order.

Error

- When 1999 or -1999 flashes with a certain measurement input, disconnect power supply and then check the cables.

Connections of Applications

DC voltmeter connection

- V1 (measuring voltage): ≤ 300 VDC≐
- V1 (measuring voltage): ≥ 300 VDC≐

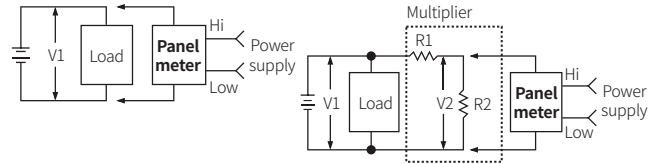

Select R1 and R2 in order to make V2 less than max. measuring voltage using multiplier.

$$V2 = \frac{R2}{R1+R2} \times V1$$

AC voltmeter connection

- V1 (measuring voltage): ≤ 400 VAC~
- V1 (measuring voltage): ≥ 400 VAC~

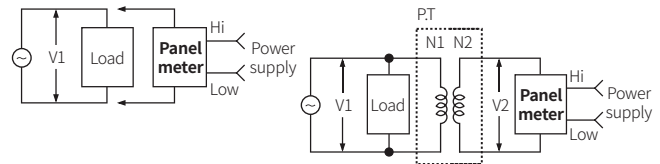

When measurement voltage is higher than 400 VAC~, use the PT on the external. (V2 ≤ max. measuring voltage)

$$V2 = \frac{N2}{N1} \times V1$$

DC ammeter connection

- I (measuring current): ≤ DC 2 A
- I (measuring current): ≥ DC 2 A

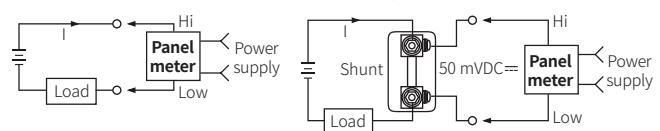

When the current is higher than DC 2 A, use shunt. Second section of shunt is 50 mVDC≐.

AC ammeter connection

- I (measuring current): ≤ AC 5 A
- I (measuring current): ≥ AC 5 A

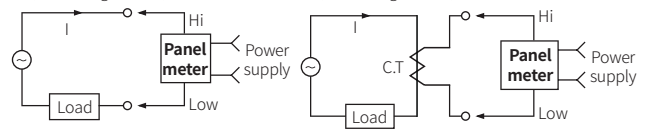

If the current is higher than AC 5 A, use C.T.

Simultaneous connection of voltmeter and ammeter

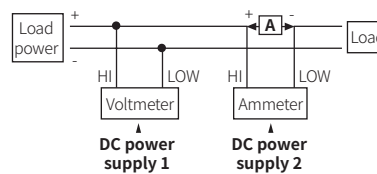

- A: Compared to measurement input range, higher measuring voltage needs a multiplier and lower measuring voltage needs shunts.
- Connect the separated power supply each.
- (-) terminal of the power and (-) terminal of measurement input are shorted. In case of using same power supply, measurement error or overcurrent may occur.

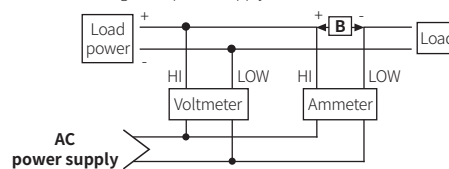

- B: When measuring higher current than measurement input, use a shunt for DC current and a current transformer (C.T.) for AC current.

Power meter connection

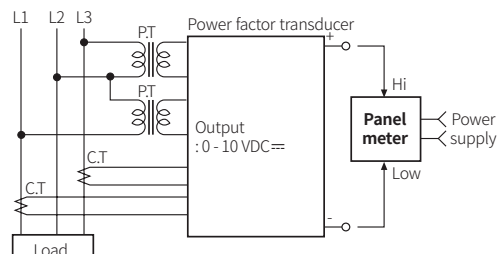

■ Rotation / Speed meter connection

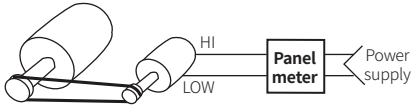

Motor Tacho generator (T.G)

- Tacho generator (T.G)

: This generator makes a voltage in proportion to revolution speed of motor. The panel meter receives the voltage and displays the number of revolution.
There are AC voltage and DC voltage for output voltage.

■ Scaling meter connection

