



Mitsubishi Programmable Controller

MELSEC iQ-R
series

MELSEC iQ-R Channel Isolated
Analog-Digital Converter Module
User's Manual (Startup)

-R60AD8-G
-R60AD16-G



SAFETY PRECAUTIONS

(Read these precautions before using this product.)

Before using this product, please read this manual and the relevant manuals carefully and pay full attention to safety to handle the product correctly.

The precautions given in this manual are concerned with this product only. For the safety precautions of the programmable controller system, refer to the MELSEC iQ-R Module Configuration Manual.

In this manual, the safety precautions are classified into two levels: "⚠ WARNING" and "⚠ CAUTION".

 WARNING	Indicates that incorrect handling may cause hazardous conditions, resulting in death or severe injury.
 CAUTION	Indicates that incorrect handling may cause hazardous conditions, resulting in minor or moderate injury or property damage.

Under some circumstances, failure to observe the precautions given under "⚠ CAUTION" may lead to serious consequences.

Observe the precautions of both levels because they are important for personal and system safety.

Make sure that the end users read this manual and then keep the manual in a safe place for future reference.

[Design Precautions]

WARNING

- Configure safety circuits external to the programmable controller to ensure that the entire system operates safely even when a fault occurs in the external power supply or the programmable controller. Failure to do so may result in an accident due to an incorrect output or malfunction.
 - (1) Emergency stop circuits, protection circuits, and protective interlock circuits for conflicting operations (such as forward/reverse rotations or upper/lower limit positioning) must be configured external to the programmable controller.
 - (2) When the programmable controller detects an abnormal condition, it stops the operation and all outputs are:
 - Turned off if the overcurrent or overvoltage protection of the power supply module is activated.
 - Held or turned off according to the parameter setting if the self-diagnostic function of the CPU module detects an error such as a watchdog timer error.
 - (3) All outputs may be turned on if an error occurs in a part, such as an I/O control part, where the CPU module cannot detect any error. To ensure safety operation in such a case, provide a safety mechanism or a fail-safe circuit external to the programmable controller. For a fail-safe circuit example, refer to "General Safety Requirements" in the MELSEC iQ-R Module Configuration Manual.
 - (4) Outputs may remain on or off due to a failure of a component such as a relay and transistor in an output circuit. Configure an external circuit for monitoring output signals that could cause a serious accident.
 - In an output circuit, when a load current exceeding the rated current or an overcurrent caused by a load short-circuit flows for a long time, it may cause smoke and fire. To prevent this, configure an external safety circuit, such as a fuse.
 - Configure a circuit so that the programmable controller is turned on first and then the external power supply. If the external power supply is turned on first, an accident may occur due to an incorrect output or malfunction.
 - For the operating status of each station after a communication failure, refer to manuals relevant to the network. Incorrect output or malfunction due to a communication failure may result in an accident.
 - When connecting an external device with a CPU module or intelligent function module to modify data of a running programmable controller, configure an interlock circuit in the program to ensure that the entire system will always operate safely. For other forms of control (such as program modification, parameter change, forced output, or operating status change) of a running programmable controller, read the relevant manuals carefully and ensure that the operation is safe before proceeding. Improper operation may damage machines or cause accidents.
 - Especially, when a remote programmable controller is controlled by an external device, immediate action cannot be taken if a problem occurs in the programmable controller due to a communication failure. To prevent this, configure an interlock circuit in the program, and determine corrective actions to be taken between the external device and CPU module in case of a communication failure.
 - Do not write any data to the "system area" and "write-protect area" of the buffer memory in the module. Also, do not use any "use prohibited" signals as an output signal from the CPU module to each module. Doing so may cause malfunction of the programmable controller system. For the "system area", "write-protect area", and the "use prohibited" signals, refer to the user's manual for the module used.
-

[Design Precautions]

WARNING

- If a communication cable is disconnected, the network may be unstable, resulting in a communication failure of multiple stations. Configure an interlock circuit in the program to ensure that the entire system will always operate safely even if communications fail. Failure to do so may result in an accident due to an incorrect output or malfunction.
 - To maintain the safety of the programmable controller system against unauthorized access from external devices via the network, take appropriate measures. To maintain the safety against unauthorized access via the Internet, take measures such as installing a firewall.
-

[Design Precautions]

CAUTION

- Do not install the control lines or communication cables together with the main circuit lines or power cables. Keep a distance of 100mm or more between them. Failure to do so may result in malfunction due to noise.
 - During control of an inductive load such as a lamp, heater, or solenoid valve, a large current (approximately ten times greater than normal) may flow when the output is turned from off to on. Therefore, use a module that has a sufficient current rating.
 - After the CPU module is powered on or is reset, the time taken to enter the RUN status varies depending on the system configuration, parameter settings, and/or program size. Design circuits so that the entire system will always operate safely, regardless of the time.
 - Do not power off the programmable controller or reset the CPU module while the settings are being written. Doing so will make the data in the flash ROM undefined. The values need to be set in the buffer memory and written to the flash ROM again. Doing so also may cause malfunction or failure of the module.
 - When changing the operating status of the CPU module from external devices (such as the remote RUN/STOP functions), select "Do Not OPEN in Program" for "Open Method Setting" in the module parameters. If "OPEN in Program" is selected, an execution of the remote STOP function causes the communication line to close. Consequently, the CPU module cannot reopen the line, and external devices cannot execute the remote RUN function.
-

[Installation Precautions]

WARNING

- Shut off the external power supply (all phases) used in the system before mounting or removing the module. Failure to do so may result in electric shock or cause the module to fail or malfunction.
-

[Installation Precautions]

CAUTION

- Use the programmable controller in an environment that meets the general specifications in the Safety Guidelines included with the base unit. Failure to do so may result in electric shock, fire, malfunction, or damage to or deterioration of the product.
 - To mount a module, place the concave part(s) located at the bottom onto the guide(s) of the base unit, and push in the module until the hook(s) located at the top snaps into place. Incorrect interconnection may cause malfunction, failure, or drop of the module.
 - When using the programmable controller in an environment of frequent vibrations, fix the module with a screw.
 - Tighten the screws within the specified torque range. Undertightening can cause drop of the screw, short circuit, or malfunction. Overtightening can damage the screw and/or module, resulting in drop, short circuit, or malfunction.
 - When using an extension cable, connect it to the extension cable connector of the base unit securely. Check the connection for looseness. Poor contact may cause malfunction.
 - When using an SD memory card, fully insert it into the SD memory card slot. Check that it is inserted completely. Poor contact may cause malfunction.
 - Securely insert an extended SRAM cassette into the cassette connector of the CPU module. After insertion, close the cassette cover and check that the cassette is inserted completely. Poor contact may cause malfunction.
 - Do not directly touch any conductive parts and electronic components of the module, SD memory card, extended SRAM cassette, or connector. Doing so can cause malfunction or failure of the module.
-

[Wiring Precautions]

WARNING

- Shut off the external power supply (all phases) used in the system before installation and wiring. Failure to do so may result in electric shock or cause the module to fail or malfunction.
 - After installation and wiring, attach the included terminal cover to the module before turning it on for operation. Failure to do so may result in electric shock.
-

[Wiring Precautions]

CAUTION

- Individually ground the FG and LG terminals of the programmable controller with a ground resistance of 100 ohms or less. Failure to do so may result in electric shock or malfunction.
 - Use applicable solderless terminals and tighten them within the specified torque range. If any spade solderless terminal is used, it may be disconnected when the terminal screw comes loose, resulting in failure.
 - Check the rated voltage and signal layout before wiring to the module, and connect the cables correctly. Connecting a power supply with a different voltage rating or incorrect wiring may cause fire or failure.
 - Connectors for external devices must be crimped or pressed with the tool specified by the manufacturer, or must be correctly soldered. Incomplete connections may cause short circuit, fire, or malfunction.
 - Securely connect the connector to the module. Poor contact may cause malfunction.
 - Do not install the control lines or communication cables together with the main circuit lines or power cables. Keep a distance of 100mm or more between them. Failure to do so may result in malfunction due to noise.
 - Place the cables in a duct or clamp them. If not, dangling cable may swing or inadvertently be pulled, resulting in damage to the module or cables or malfunction due to poor contact. Do not clamp the extension cables with the jacket stripped.
 - Check the interface type and correctly connect the cable. Incorrect wiring (connecting the cable to an incorrect interface) may cause failure of the module and external device.
 - Tighten the terminal screws or connector screws within the specified torque range. Undertightening can cause drop of the screw, short circuit, fire, or malfunction. Overtightening can damage the screw and/or module, resulting in drop, short circuit, fire, or malfunction.
 - When disconnecting the cable from the module, do not pull the cable by the cable part. For the cable with connector, hold the connector part of the cable. For the cable connected to the terminal block, loosen the terminal screw. Pulling the cable connected to the module may result in malfunction or damage to the module or cable.
 - Prevent foreign matter such as dust or wire chips from entering the module. Such foreign matter can cause a fire, failure, or malfunction.
 - A protective film is attached to the top of the module to prevent foreign matter, such as wire chips, from entering the module during wiring. Do not remove the film during wiring. Remove it for heat dissipation before system operation.
 - Programmable controllers must be installed in control panels. Connect the main power supply to the power supply module in the control panel through a relay terminal block. Wiring and replacement of a power supply module must be performed by qualified maintenance personnel with knowledge of protection against electric shock. For wiring, refer to the MELSEC iQ-R Module Configuration Manual.
 - For Ethernet cables to be used in the system, select the ones that meet the specifications in the user's manual for the module used. If not, normal data transmission is not guaranteed.
 - Individually ground the shielded cables of the programmable controller with a ground resistance of 100 ohms or less. Failure to do so may result in electric shock or malfunction.
-

[Startup and Maintenance Precautions]

WARNING

- Do not touch any terminal while power is on. Doing so will cause electric shock or malfunction.
 - Correctly connect the battery connector. Do not charge, disassemble, heat, short-circuit, solder, or throw the battery into the fire. Also, do not expose it to liquid or strong shock. Doing so will cause the battery to produce heat, explode, ignite, or leak, resulting in injury and fire.
 - Shut off the external power supply (all phases) used in the system before cleaning the module or retightening the terminal screws, connector screws, or module fixing screws. Failure to do so may result in electric shock.
-

[Startup and Maintenance Precautions]

CAUTION

- When connecting an external device with a CPU module or intelligent function module to modify data of a running programmable controller, configure an interlock circuit in the program to ensure that the entire system will always operate safely. For other forms of control (such as program modification, parameter change, forced output, or operating status change) of a running programmable controller, read the relevant manuals carefully and ensure that the operation is safe before proceeding. Improper operation may damage machines or cause accidents.
 - Especially, when a remote programmable controller is controlled by an external device, immediate action cannot be taken if a problem occurs in the programmable controller due to a communication failure. To prevent this, configure an interlock circuit in the program, and determine corrective actions to be taken between the external device and CPU module in case of a communication failure.
 - Do not disassemble or modify the modules. Doing so may cause failure, malfunction, injury, or a fire.
 - Use any radio communication device such as a cellular phone or PHS (Personal Handy-phone System) more than 25cm away in all directions from the programmable controller. Failure to do so may cause malfunction.
 - Shut off the external power supply (all phases) used in the system before mounting or removing the module. Failure to do so may cause the module to fail or malfunction.
 - Tighten the screws within the specified torque range. Undertightening can cause drop of the component or wire, short circuit, or malfunction. Overtightening can damage the screw and/or module, resulting in drop, short circuit, or malfunction.
 - After the first use of the product, do not mount/remove the module to/from the base unit, and the terminal block to/from the module, and do not insert/remove the extended SRAM cassette to/from the CPU module more than 50 times (IEC 61131-2 compliant) respectively. Exceeding the limit may cause malfunction.
 - After the first use of the product, do not insert/remove the SD memory card to/from the CPU module more than 500 times. Exceeding the limit may cause malfunction.
 - Do not touch the metal terminals on the back side of the SD memory card. Doing so may cause malfunction or failure of the module.
 - Do not touch the integrated circuits on the circuit board of an extended SRAM cassette. Doing so may cause malfunction or failure of the module.
 - Do not drop or apply shock to the battery to be installed in the module. Doing so may damage the battery, causing the battery fluid to leak inside the battery. If the battery is dropped or any shock is applied to it, dispose of it without using.
 - Startup and maintenance of a control panel must be performed by qualified maintenance personnel with knowledge of protection against electric shock. Lock the control panel so that only qualified maintenance personnel can operate it.
 - Before handling the module, touch a conducting object such as a grounded metal to discharge the static electricity from the human body. Failure to do so may cause the module to fail or malfunction.
-

[Operating Precautions]

CAUTION

- When changing data and operating status, and modifying program of the running programmable controller from an external device such as a personal computer connected to an intelligent function module, read relevant manuals carefully and ensure the safety before operation. Incorrect change or modification may cause system malfunction, damage to the machines, or accidents.
 - Do not power off the programmable controller or reset the CPU module while the setting values in the buffer memory are being written to the flash ROM in the module. Doing so will make the data in the flash ROM undefined. The values need to be set in the buffer memory and written to the flash ROM again. Doing so can cause malfunction or failure of the module.
-

[Disposal Precautions]

CAUTION

- When disposing of this product, treat it as industrial waste.
 - When disposing of batteries, separate them from other wastes according to the local regulations. For details on battery regulations in EU member states, refer to the MELSEC iQ-R Module Configuration Manual.
-

[Transportation Precautions]

CAUTION

- When transporting lithium batteries, follow the transportation regulations. For details on the regulated models, refer to the MELSEC iQ-R Module Configuration Manual.
 - The halogens (such as fluorine, chlorine, bromine, and iodine), which are contained in a fumigant used for disinfection and pest control of wood packaging materials, may cause failure of the product. Prevent the entry of fumigant residues into the product or consider other methods (such as heat treatment) instead of fumigation. The disinfection and pest control measures must be applied to unprocessed raw wood.
-

CONDITIONS OF USE FOR THE PRODUCT

(1) Mitsubishi programmable controller ("the PRODUCT") shall be used in conditions;

- i) where any problem, fault or failure occurring in the PRODUCT, if any, shall not lead to any major or serious accident; and
- ii) where the backup and fail-safe function are systematically or automatically provided outside of the PRODUCT for the case of any problem, fault or failure occurring in the PRODUCT.

(2) The PRODUCT has been designed and manufactured for the purpose of being used in general industries.

MITSUBISHI SHALL HAVE NO RESPONSIBILITY OR LIABILITY (INCLUDING, BUT NOT LIMITED TO ANY AND ALL RESPONSIBILITY OR LIABILITY BASED ON CONTRACT, WARRANTY, TORT, PRODUCT LIABILITY) FOR ANY INJURY OR DEATH TO PERSONS OR LOSS OR DAMAGE TO PROPERTY CAUSED BY the PRODUCT THAT ARE OPERATED OR USED IN APPLICATION NOT INTENDED OR EXCLUDED BY INSTRUCTIONS, PRECAUTIONS, OR WARNING CONTAINED IN MITSUBISHI'S USER, INSTRUCTION AND/OR SAFETY MANUALS, TECHNICAL BULLETINS AND GUIDELINES FOR the PRODUCT.

("Prohibited Application")

Prohibited Applications include, but not limited to, the use of the PRODUCT in;

- Nuclear Power Plants and any other power plants operated by Power companies, and/or any other cases in which the public could be affected if any problem or fault occurs in the PRODUCT.
- Railway companies or Public service purposes, and/or any other cases in which establishment of a special quality assurance system is required by the Purchaser or End User.
- Aircraft or Aerospace, Medical applications, Train equipment, transport equipment such as Elevator and Escalator, Incineration and Fuel devices, Vehicles, Manned transportation, Equipment for Recreation and Amusement, and Safety devices, handling of Nuclear or Hazardous Materials or Chemicals, Mining and Drilling, and/or other applications where there is a significant risk of injury to the public or property.

Notwithstanding the above, restrictions Mitsubishi may in its sole discretion, authorize use of the PRODUCT in one or more of the Prohibited Applications, provided that the usage of the PRODUCT is limited only for the specific applications agreed to by Mitsubishi and provided further that no special quality assurance or fail-safe, redundant or other safety features which exceed the general specifications of the PRODUCTS are required. For details, please contact the Mitsubishi representative in your region.

INTRODUCTION

Thank you for purchasing the Mitsubishi MELSEC iQ-R series programmable controllers.

This manual describes the performance specifications, procedures before operation, wiring, and operation examples of the relevant products listed below.

Before using this product, please read this manual and the relevant manuals carefully and develop familiarity with the functions and performance of the MELSEC iQ-R series programmable controller to handle the product correctly.

When applying the program examples provided in this manual to an actual system, ensure the applicability and confirm that it will not cause system control problems.

Please make sure that the end users read this manual.



Unless otherwise specified, this manual provides program examples in which the I/O numbers of X/Y0 to X/YF are assigned to the A/D converter module. Assign I/O numbers when applying the program examples to an actual system. For I/O number assignment, refer to the following.

MELSEC iQ-R Module Configuration Manual



Relevant products

R60AD8-G, R60AD16-G

COMPLIANCE WITH EMC AND LOW VOLTAGE DIRECTIVES

Method of ensuring compliance

To ensure that Mitsubishi programmable controllers maintain EMC and Low Voltage Directives when incorporated into other machinery or equipment, certain measures may be necessary. Please refer to one of the following manuals.

-  MELSEC iQ-R Module Configuration Manual
-  Safety Guidelines (This manual is included with the base unit.)

The CE mark on the side of the programmable controller indicates compliance with EMC and Low Voltage Directives.

Additional measures

No additional measures are necessary for the compliance of this product with the EMC and Low Voltage Directives.

CONTENTS

SAFETY PRECAUTIONS	1
CONDITIONS OF USE FOR THE PRODUCT	9
INTRODUCTION	9
COMPLIANCE WITH EMC AND LOW VOLTAGE DIRECTIVES	10
RELEVANT MANUALS	12
TERMS	12
CHAPTER 1 PART NAMES	14
CHAPTER 2 SPECIFICATIONS	16
2.1 Performance Specifications	16
CHAPTER 3 FUNCTION LIST	18
CHAPTER 4 PROCEDURES BEFORE OPERATION	20
CHAPTER 5 WIRING	22
5.1 Wiring Precautions	22
Connectors for external devices	22
5.2 External Wiring	23
Signal layout of the connector for external devices	23
CHAPTER 6 OPERATION EXAMPLES	26
6.1 Programming Procedure	26
6.2 Program Examples	26
CHAPTER 7 OFFSET/GAIN SETTING	32
7.1 Setting Procedure	32
APPENDICES	36
Appendix 1 I/O Conversion Characteristics	36
Appendix 2 Accuracy	41
Appendix 3 External Dimensions	42
INDEX	44
REVISIONS	46
WARRANTY	47
TRADEMARKS	48

RELEVANT MANUALS

Manual name [manual number]	Description	Available form
MELSEC iQ-R Channel Isolated Analog-Digital Converter Module User's Manual (Startup) [SH-081485ENG] (this manual)	Performance specifications, procedures before operation, wiring, operation examples, and offset/gain setting of the A/D converter module	Print book e-Manual PDF
MELSEC iQ-R Channel Isolated Analog-Digital Converter Module User's Manual (Application) [SH-081487ENG]	Functions, parameter settings, troubleshooting, I/O signals, and buffer memory of the A/D converter module	Print book e-Manual PDF
MELSEC iQ-R Programming Manual (Instructions, Standard Functions/Function Blocks) [SH-081266ENG]	Instructions for the CPU module, dedicated instructions for the intelligent function modules, and standard functions/function blocks	e-Manual PDF

This manual does not include detailed information on the following:

- General specifications
- Applicable CPU modules and the number of mountable modules
- Installation

For details, refer to the following.

 MELSEC iQ-R Module Configuration Manual

This manual does not include information on the module function blocks.

For details, refer to the Function Block Reference for the module used.

Point

e-Manual refers to the Mitsubishi FA electronic book manuals that can be browsed using a dedicated tool.

e-Manual has the following features:

- Required information can be cross-searched in multiple manuals.
- Other manuals can be accessed from the links in the manual.
- The hardware specifications of each part can be found from the product figures.
- Pages that users often browse can be bookmarked.

TERMS

Unless otherwise specified, this manual uses the following terms.

Term	Description
A/D converter module	The abbreviation for the MELSEC iQ-R series channel isolated analog-digital converter module
GX Works3	The product name of the software package for the MELSEC programmable controllers
Q compatible mode	A mode in which the module operates with the buffer memory map converted to the equivalent one of the MELSEC Q series
R mode	A mode in which the module operates with the buffer memory map that has been newly laid out in the MELSEC iQ-R series
Watchdog timer error	An error that occurs if the internal processing of the A/D converter module fails. The module monitors its own internal processing by using the watchdog timer.
Engineering tool	Another term for GX Works3
Offset/gain setting mode	A mode used for the offset/gain setting
Global label	A label that is valid for all the program data when multiple program data are created in the project. There are two types of global label: a module specific label (module label), which is generated automatically by GX Works3, and an optional label, which can be created for any specified device.
Factory default setting	A generic term for analog input ranges of 0 to 10V, 0 to 5V, 1 to 5V, -10 to 10V, 0 to 20mA, 4 to 20mA, 1 to 5V (extended mode), and 4 to 20mA (extended mode). In the window on the engineering tool, 4 to 20mA (extended mode) and 1 to 5V (extended mode) are displayed as the following: <ul style="list-style-type: none"> • 4 to 20mA (Extension) • 1 to 5V (Extension)
Normal mode	A mode used for normal A/D conversion. In the engineering tool, the item name of the mode is displayed as "Normal mode (A/D conversion process)".
Buffer memory	A memory in an intelligent module for storing data (such as setting values and monitored values) to be transferred to the CPU module
User range	An analog input range where any value can be set. This range can be set in the offset/gain setting.

Term	Description
Module label	A label that represents one of memory areas (I/O signals and buffer memory areas) specific to each module in a given character string. For the module used, GX Works3 automatically generates this label, which can be used as a global label.

1 PART NAMES

This chapter describes the part names of the A/D converter module.

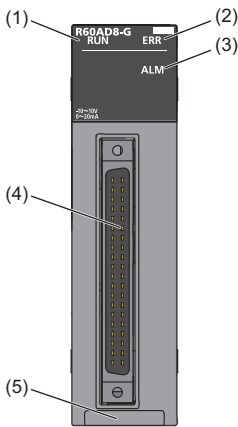

No.	Name	Description
(1)	RUN LED	Indicates the operating status of the module. On: Normal operation Flashing (cycle of 1s): In offset/gain setting mode Flashing (cycle of 400ms): Selected as a module for the online module change Off: 5V power supply interrupted, watchdog timer error occurred, or module change permitted in the process of online module change
(2)	ERR LED	Indicates the error status of the module.*1 On: Error occurred Off: Normal operation
(3)	ALM LED	Indicates the alarm status of the module.*1 On: Alert (process alarm or rate alarm) issued Flashing: Input signal error detected Off: Normal operation
(4)	Connector for external devices	Connector for connection to input signal wires from external devices and others For the signal layout, refer to the following. ☞ Page 23 Signal layout of the connector for external devices
(5)	Production information marking	Shows the product information (16 digits) of the module.

*1 For details, refer to the following.

📖 MELSEC iQ-R Channel Isolated Analog-Digital Converter Module User's Manual (Application)

2 SPECIFICATIONS

This chapter describes the performance specifications.

2.1 Performance Specifications

This section describes the performance specifications of the A/D converter modules.

R60AD8-G, R60AD16-G

Item	Specifications			
Number of analog input channels	<ul style="list-style-type: none"> • R60AD8-G: 8 channels • R60AD16-G: 16 channels 			
Analog input voltage	-10 to 10VDC (input resistance 1M Ω)			
Analog input current	0 to 20mADC (input resistance 250 Ω)			
Digital output value	16-bit signed binary value (-32768 to 32767)			
I/O conversion characteristics, resolution ^{*1}	Analog input range		Digital output value	
	Voltage	0 to 10V	0 to 32000	312.5 μ V
		0 to 5V		156.3 μ V
		1 to 5V		125.0 μ V
		1 to 5V (extended mode)	-8000 to 32767 (-8000 to 36000) ^{*10}	125.0 μ V
		-10 to 10V	-32000 to 32000	312.5 μ V
		User range setting		29.2 μ V ^{*9}
	Current	0 to 20mA	0 to 32000	625.0nA
		4 to 20mA		500.0nA
		4 to 20mA (extended mode)	-8000 to 32767 (-8000 to 36000) ^{*10}	500.0nA
User range setting		-32000 to 32000	115.5nA ^{*9}	
Accuracy (accuracy of the maximum digital output value) ^{*2}	Reference accuracy: Within $\pm 0.1\%$ (± 32 digit) ^{*3} Temperature coefficient: ± 35 ppm/ $^{\circ}$ C (0.0035%/ $^{\circ}$ C) ^{*4}			
Common mode characteristics	Common mode voltage between input and common ground (input voltage 0V): 500VAC			
	Common mode voltage rejection ratio (VCM < 500V): 60Hz 107dB, 50Hz 106dB			
Conversion speed ^{*5}	10ms/CH			
Response time ^{*6}	20ms			
Absolute maximum input	Voltage: ± 15 V, Current: 30mA ^{*7}			
Number of offset/gain settings ^{*8}	50000 times maximum			
Isolation method	Between I/O terminals and programmable controller power supply: Transformer Between analog input channels: Transformer			
Withstand voltage	Between I/O terminals and programmable controller power supply: 500VACrms for 1 minute Between analog input channels: 1000VACrms for 1 minute			
Insulation resistance	Between I/O terminals and programmable controller power supply: 10M Ω or higher, at 500VDC Between analog input channels: 10M Ω or higher, at 500VDC			
Number of occupied I/O points	<ul style="list-style-type: none"> • R60AD8-G: 16 points, 1 slot (I/O assignment: Intelligent 16 points) • R60AD16-G: 32 points, 2 slots (I/O assignment: Empty 16 points + Intelligent 16 points) 			
External interface	40-pin connector			
Applicable wire size	When A6CON1 and A6CON4 are used	0.088 to 0.3mm ² (28 to 22 AWG) (stranded wire)		
	When A6CON2 is used	0.088 to 0.24mm ² (28 to 24 AWG) (stranded wire)		
Connector for external devices	A6CON1, A6CON2, A6CON4 (sold separately)			
Internal current consumption (5VDC)	<ul style="list-style-type: none"> • R60AD8-G: 0.33A • R60AD16-G: 0.52A 			
External dimensions	Height	106mm (Base unit mounting side: 98mm)		
	Width	<ul style="list-style-type: none"> • R60AD8-G: 27.8mm • R60AD16-G: 56mm 		
	Depth	110mm		

Item	Specifications
Weight	<ul style="list-style-type: none"> • R60AD8-G: 0.19kg • R60AD16-G: 0.26kg

*1 For details on the I/O conversion characteristics, refer to the following.

 Page 36 I/O Conversion Characteristics

*2 Except for the conditions under noise influence.

*3 The accuracy at an ambient temperature when the offset/gain setting is configured.

*4 The accuracy based on a temperature change of 1°C.

*5 The period at which the digital output value is updated.

*6 The time taken for an analog input signal to arrive at the A/D converter inside the module.

*7 These voltage and current values are instantaneous values at which no breakdown occurs in the internal resistance of the module.

*8 A count more than 50000 times causes Number of writes to offset/gain settings reach limit error (error code: 1080H).

*9 Maximum resolution in the user range setting.

*10 The range of data that is stored in Digital output value (32 bits).

Restrictions

The module R60AD16-G takes up two slots and so there are restrictions on the available firmware version of the RCP module. For details, refer to the following.

-  MELSEC iQ-R CPU Module User's Manual (Application)

3 FUNCTION LIST

The following table lists the functions of the A/D converter module. For further details on the functions, refer to the following.
 MELSEC iQ-R Channel Isolated Analog-Digital Converter Module User's Manual (Application)

Item		Description	
Range switching function		Allows the input range of analog input to be switched for each channel. Switching the range makes it possible to change the I/O conversion characteristics.	
A/D conversion enable/disable setting function		Controls whether to enable or disable A/D conversion for each channel. Disabling A/D conversion for unused channels reduces the conversion cycles.	
A/D conversion method	Sampling processing	Converts analog input values into digital output values at every sampling period, storing them in buffer memory areas.	
	Averaging processing	Time average	Executes A/D conversion for the set time and performs the averaging processing on the total value excluding the maximum and minimum values. The processed values are stored in the buffer memory area. The number of processing times within the set time changes depending on the number of channels where A/D conversion is enabled.
		Count average	Executes A/D conversion for a set number of times and performs the averaging processing on the total value excluding the maximum and minimum values. The processed values are stored in the buffer memory area. The time taken to store the average value obtained by the average processing in the buffer memory area changes depending on the number of channels where A/D conversion is enabled.
		Moving average	Averages digital output values taken at every sampling period for a specified number of times, and stores the averaged value in the buffer memory area. The target range for averaging processing moves at each sampling period, thereby allowing the latest digital output value to be obtained.
Primary delay filter		Smooths the transient noise of analog input depending on the set time constant. The smoothed digital output values are stored in the buffer memory area.	
Scaling function		Performs scale conversion on digital output values within the range from a scaling upper limit value to a scaling lower limit value, both of which are set at desired values. This function reduces the time and effort to create a program of the scale conversion.	
Alert output function	Process alarm	Outputs an alert when a digital operation value falls within the preset alert output range.	
	Rate alarm	Outputs an alert if the change rate of a digital output value is equal to or more than the rate alarm upper limit value, or is equal to or less than the rate alarm lower limit value.	
Input signal error detection function	Upper limit detection, lower limit detection, upper and lower limit detection	Outputs an alarm when an analog input value exceeds the preset range.	
	Simple disconnection detection	Outputs an alarm when an analog input value is 0.5V or smaller or 2mA or smaller.	
Shift function		Adds (shifts) a set conversion value shift amount to a digital output value, and stores the result in the buffer memory area. A change in conversion value shift amount is reflected to the digital operation value in real time, which facilitates fine adjustment at system start-up.	
Digital clipping function		Fixes a possible digital operation value to the maximum digital output value or the minimum digital output value when an input current or voltage exceeds the input range.	
Difference conversion function		Subtracts a difference conversion reference value from a digital operation value and stores the resulting value in the buffer memory area.	
Maximum value/minimum value hold function		Stores the maximum and minimum values of digital operation values in the buffer memory area for each channel.	
Logging function		Logs (records) digital output values or digital operation values. For each channel, 1000 points data can be logged.	
Logging read function		Makes it possible to store more than 1000 points of logging data without stopping logging by transferring the device data to the file register of the CPU module during logging. This function reduces the takt time in a test demanding high-speed conversion.	
Interrupt function		Executes an interrupt program of the CPU module when an interrupt factor such as an input signal error or alert output is detected.	
Error history function		Records errors and alarms that have occurred in the A/D converter module, storing the record into the buffer memory area. Up to 16 storage areas are provided for errors and alarms, respectively.	
Event history function		Collects generated errors and alarms, and performed operations in the A/D converter module as event information into the CPU module.	
Offset/gain setting		Allows the correction of errors in digital output values.	
Backing up, saving, and restoring offset/gain values		The A/D converter module is capable of backing up, saving, and restoring offset/gain values of the user range setting.	

Item	Description
Online module change	<p>Allows module change without stopping the system. For the procedure of the online module change, refer to the following.</p> <p> MELSEC iQ-R Online Module Change Manual</p>
Q compatible mode function	<p>Allows the buffer memory addresses of the A/D converter module to be the same layout as the MELSEC-Q series module.</p> <p>This compatibility makes it possible to reuse sequence programs that have exhibited high performance on the MELSEC-Q series modules.</p>

4 PROCEDURES BEFORE OPERATION

This chapter describes the procedures before operation.

1. Mounting a module

Mount the A/D converter module in any desired configuration.

☞ Page 26 System configuration

2. Wiring

Perform wiring of external devices to the A/D converter module.

☞ Page 23 External Wiring

3. Adding a module

Add the A/D converter module to a module configuration by using the engineering tool. For details, refer to the following.

📖 GX Works3 Operating Manual

4. Parameter settings

Set up the parameters of the A/D converter module by using the engineering tool. For details, refer to the following.

📖 MELSEC iQ-R Channel Isolated Analog-Digital Converter Module User's Manual (Application)

5. Offset/gain setting

Perform the offset/gain setting to set a user range, if necessary.

☞ Page 32 OFFSET/GAIN SETTING

6. Programming

Create a program. For details, refer to the following.

☞ Page 26 OPERATION EXAMPLES

5 WIRING

This chapter describes the wiring of the A/D converter module.

5.1 Wiring Precautions

- Check the signal layout before wiring to the A/D converter module, and connect the cables correctly. For the signal layout, refer to the following.

 Page 23 Signal layout of the connector for external devices

- Provide a single-point ground for the shield wire and the shield of the shielded cable.

Connectors for external devices

Precautions

Tighten the connector screws within the specified torque range.

Screw type	Tightening torque range
Connector screw (M2.6)	0.20 to 0.29N·m

- Use copper wire with a temperature rating of 75°C or higher for the connector.
- Use UL listed connectors if necessary for UL compliance.

Applicable connectors

Connectors for external devices to be used for the A/D converter module are sold separately.

The following tables list the applicable connectors, and the reference product of a crimping tool

■40-pin connectors

Type	Model	Applicable wire size
Soldering type connector (straight type)	A6CON1*1	0.088 to 0.3mm ² (28 to 22 AWG) (stranded wire)
Crimping type connector (straight type)	A6CON2	0.088 to 0.24mm ² (28 to 24 AWG) (stranded wire)
Soldering type connector (dual purpose (straight/oblique) type)	A6CON4*1	0.088 to 0.3mm ² (28 to 22 AWG) (stranded wire)

*1 Select wires with a sheath outside diameter of 1.3mm or shorter when using 40 wires.
Select wires suitable to the current value used.

Point

- The A6CON3 (IDC type connector (straight type)) cannot be used.
- The connector/terminal block converter module and the dedicated cables that are designed for the MELSEC-Q series channel isolated analog module can be used. For details, refer to the following.

 Page 25 When the connector/terminal block converter module is used

■40-pin connector crimping tool

Type	Model	Contact
Crimping tool	FCN-363T-T005/H	FUJITSU COMPONENT LIMITED

For how to wire the connector and how to use the crimping tool, contact the manufacturer.

Wiring method, connection procedure, and disconnection procedure of the connector

For the wiring method, connection procedure, and disconnection procedure, refer to the following.

 MELSEC iQ-R Module Configuration Manual

5.2 External Wiring

Signal layout of the connector for external devices

The following shows the signal layout of the connector for external devices for the A/D converter module.

• R60AD8-G

Pin layout (viewed from the front of the module)	Pin number	Signal name	Pin number	Signal name
	A1	CH1 V+	B1	CH1 V-/I-
	A2	CH1 I+	B2	—
	A3	—	B3	CH2 V+
	A4	CH2 V-/I-	B4	CH2 I+
	A5	—	B5	—
	A6	CH3 V+	B6	CH3 V-/I-
	A7	CH3 I+	B7	—
	A8	—	B8	CH4 V+
	A9	CH4 V-/I-	B9	CH4 I+
	A10	—	B10	—
	A11	CH5 V+	B11	CH5 V-/I-
	A12	CH5 I+	B12	—
	A13	—	B13	CH6 V+
	A14	CH6 V-/I-	B14	CH6 I+
	A15	—	B15	—
	A16	CH7 V+	B16	CH7 V-/I-
	A17	CH7 I+	B17	—
	A18	—	B18	CH8 V+
	A19	CH8 V-/I-	B19	CH8 I+
	A20	—	B20	—

• R60AD16-G

Pin layout (viewed from the front of the module)	Pin number	Signal name	Pin number	Signal name	Pin number	Signal name	Pin number	Signal name
	2A1	CH9 V+	2B1	CH9 V-/I-	1A1	CH1 V+	1B1	CH1 V-/I-
	2A2	CH9 I+	2B2	—	1A2	CH1 I+	1B2	—
	2A3	—	2B3	CH10 V+	1A3	—	1B3	CH2 V+
	2A4	CH10 V-/I-	2B4	CH10 I+	1A4	CH2 V-/I-	1B4	CH2 I+
	2A5	—	2B5	—	1A5	—	1B5	—
	2A6	CH11 V+	2B6	CH11 V-/I-	1A6	CH3 V+	1B6	CH3 V-/I-
	2A7	CH11 I+	2B7	—	1A7	CH3 I+	1B7	—
	2A8	—	2B8	CH12 V+	1A8	—	1B8	CH4 V+
	2A9	CH12 V-/I-	2B9	CH12 I+	1A9	CH4 V-/I-	1B9	CH4 I+
	2A10	—	2B10	—	1A10	—	1B10	—
	2A11	CH13 V+	2B11	CH13 V-/I-	1A11	CH5 V+	1B11	CH5 V-/I-
	2A12	CH13 I+	2B12	—	1A12	CH5 I+	1B12	—
	2A13	—	2B13	CH14 V+	1A13	—	1B13	CH6 V+
	2A14	CH14 V-/I-	2B14	CH14 I+	1A14	CH6 V-/I-	1B14	CH6 I+
	2A15	—	2B15	—	1A15	—	1B15	—
	2A16	CH15 V+	2B16	CH15 V-/I-	1A16	CH7 V+	1B16	CH7 V-/I-
	2A17	CH15 I+	2B17	—	1A17	CH7 I+	1B17	—
	2A18	—	2B18	CH16 V+	1A18	—	1B18	CH8 V+
	2A19	CH16 V-/I-	2B19	CH16 I+	1A19	CH8 V-/I-	1B19	CH8 I+
	2A20	—	2B20	—	1A20	—	1B20	—

Examples of external wiring

Here are the examples of external wiring.

■R60AD8-G, R60AD16-G

For voltage input

Signal source: 0 to $\pm 10\text{V}$

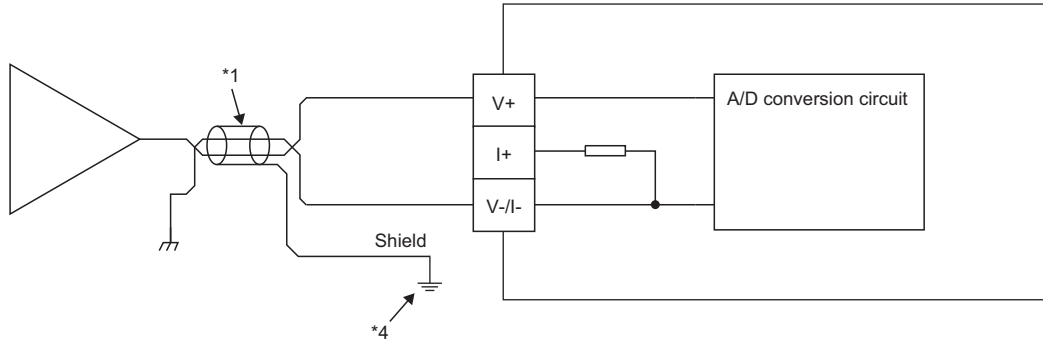

For current input

Signal source: 0 to 20mA

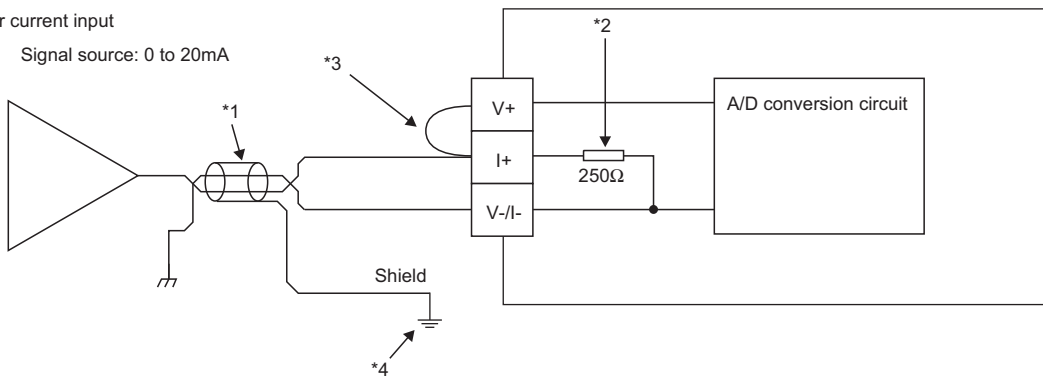

*1 For the wire, use the 2-core twisted cable.

*2 The value indicates the input resistance of the A/D converter module.

*3 For the current input, be sure to connect the terminals (V+) and (I+).

The connection between the terminal (V+) and the terminal (I+) should be made inside the connector for external devices (A6CON4) to reduce the resistance of the connecting conductor.

*4 Be sure to ground the shield wire of cables on each channel.



Ground the FG terminal of the power supply module.

When the connector/terminal block converter module is used

The A/D converter module allows the use of the connector/terminal block converter module and the dedicated cables that are designed for the Q68AD-G.

To use the connector/terminal block converter module, wire the module as shown below.

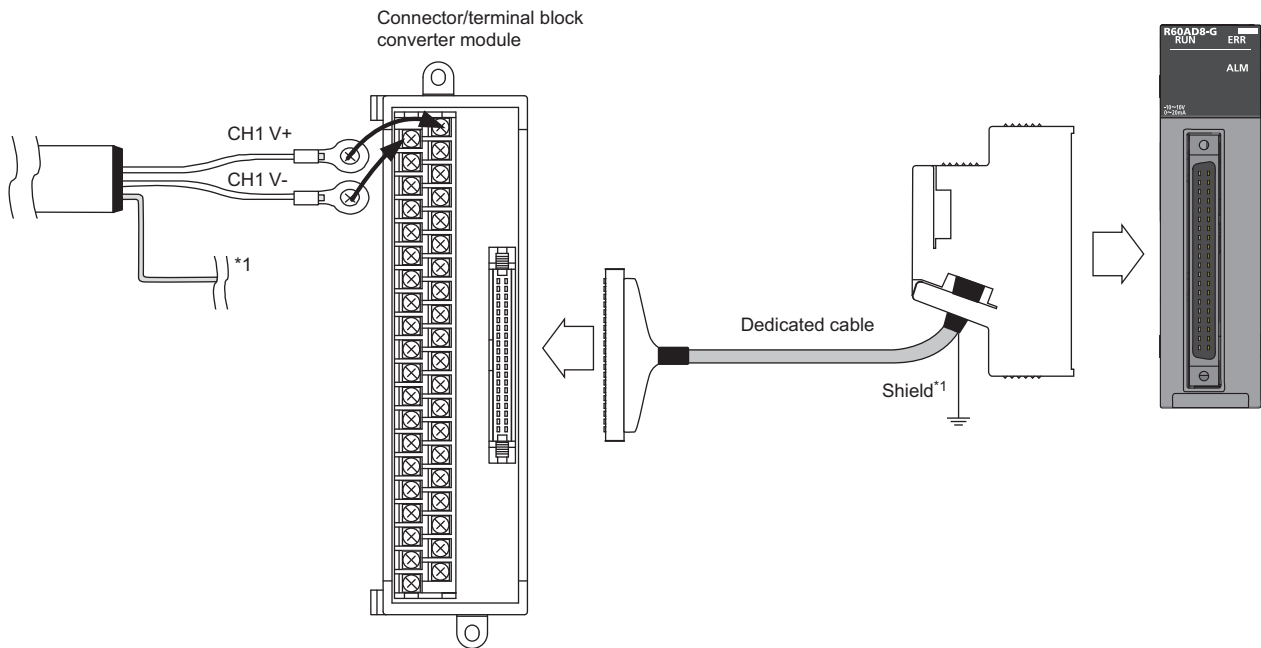

*1 Be sure to use a shielded cable. The shield must be grounded.

Product name	Model	Remarks	Contact
Connector/terminal block converter module	FA-LTB40ADGN	—	Your local Mitsubishi Electric sales office or representative
Dedicated cable	FA-CBL05Q68ADGN	Cable length 0.5m	
	FA-CBL10Q68ADGN	Cable length 1.0m	
	FA-CBL20Q68ADGN	Cable length 2.0m	
	FA-CBL30Q68ADGN	Cable length 3.0m	

Point

In the factory default settings of the modules, or the R60AD8-G and R60AD16-G, the offset/gain setting is configured with the module being independent.

For this reason, the use of the connector/terminal block converter module and the dedicated cables may cause an error in conversion characteristics due to the effect of conductor resistance and other factors.

If this effect is a problem, use the user range setting to set the offset and gain values.

For the offset/gain setting, refer to the following.

☞ Page 32 OFFSET/GAIN SETTING

6 OPERATION EXAMPLES

This chapter describes the programming procedure and the basic program of the A/D converter module.

6.1 Programming Procedure

Take the following steps to create a program for running the A/D converter module:

1. Set parameters.

☞ Page 27 Parameter settings

2. Create a program.

☞ Page 29 Program examples

Point

Using function blocks (FBs) reduces load at programming and improves the readability of programs. For details on the function blocks, refer to the following.

📖 MELSEC iQ-R Analog-Digital Converter Module/Digital-Analog Converter Module Function Block Reference

6.2 Program Examples

System configuration

The following figure is an example of the system configuration.

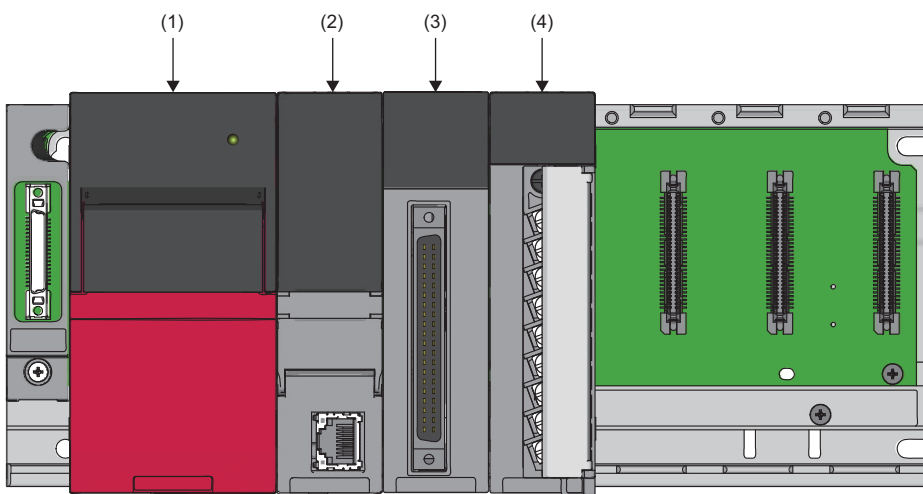

- (1) Power supply module (R61P)
- (2) CPU module (R120CPU)
- (3) A/D converter module (R60AD8-G)
- (4) Input module (RX10)

Conditions in the program

This program reads digital output values from the A/D converter module's CH1, CH3, CH5, and CH7 where A/D conversion is enabled.

The A/D conversion takes place in CH1 and CH7 by means of sampling processing; in CH3 by means of averaging processing for 50 samples; and in CH5 by means of moving average for 10 samples.

Parameter settings

Perform initial settings in the parameter settings of the engineering tool. The auto refresh setting does not need to be changed here.

For details on the parameter settings, refer to the following.

 MELSEC iQ-R Channel Isolated Analog-Digital Converter Module User's Manual (Application)

Function	Setting item	CH1	CH2	CH3	CH4	CH5	CH6	CH7	CH8
Range switching function	Input range setting	0 to 10V	—	0 to 10V	—	4 to 20mA	—	4 to 20mA	—
A/D conversion enable/disable setting function	A/D conversion enable/disable setting	A/D conversion enable	A/D conversion disable	A/D conversion enable	A/D conversion disable	A/D conversion enable	A/D conversion disable	A/D conversion enable	A/D conversion disable
A/D conversion method	Averaging process specification	Sampling processing	—	Count average	—	Moving average	—	Sampling processing	—
	Time average/Count average/Moving average/Primary delay filter constant setting	—	—	50	—	10	—	—	—
Scaling function	Scaling enable/disable setting	Disable	—	Disable	—	Enable	—	Disable	—
	Scaling upper limit value	—	—	—	—	16000	—	—	—
	Scaling lower limit value	—	—	—	—	2000	—	—	—
Shift function	Conversion value shift amount	0	—	0	—	2000	—	0	—
Digital clipping function	Digital clipping enable/disable setting	Disable	—	Disable	—	Enable	—	Disable	—
Alert output function (process alarm)	Alert output setting (process alarm)	Disable	—	Enable	—	Disable	—	Disable	—
	Process alarm upper upper limit value	—	—	32000	—	—	—	—	—
	Process alarm upper lower limit value	—	—	28000	—	—	—	—	—
	Process alarm lower upper limit value	—	—	4000	—	—	—	—	—
	Process alarm lower lower limit value	—	—	0	—	—	—	—	—
Alert output function (rate alarm)	Alert output setting (rate alarm)	Enable	—	Disable	—	Disable	—	Disable	—
	Rate alarm alert detection cycle setting	400 times	—	—	—	—	—	—	—
	Rate alarm upper limit value	25.0%	—	—	—	—	—	—	—
	Rate alarm lower limit value	-50.0%	—	—	—	—	—	—	—
Input signal error detection function	Input signal error detection setting	Upper/lower limit detection	—	Disable	—	Disable	—	Disable	—
	Input signal error detection upper limit setting value	8.0%	—	—	—	—	—	—	—
	Input signal error detection lower limit setting value	8.0%	—	—	—	—	—	—	—

Label settings

GX Works3 provides functions that support the creation of a program.

The following table lists the module labels and global labels used for the program examples in this section.

There is no need to change the settings of the module labels. For details on the global labels, refer to the following.

 MELSEC iQ-R Programming Manual (Program Design)

Classification	Label name	Description	Device		
Module label	R60ADG_1.bModuleREADY	Module READY	X0		
	R60ADG_1.bInputSignalErrorDetectionSignal	Input signal error detection signal	X0C		
	R60ADG_1.bMaxValueMinValueResetCompletedFlag	Maximum value/minimum value reset completed flag	X0D		
	R60ADG_1.bA_D_conversionCompletedFlag	A/D conversion completed flag	X0E		
	R60ADG_1.bErrorFlag	Error flag	X0F		
	R60ADG_1.bOperatingConditionSettingRequest	Operating condition setting request	Y9		
	R60ADG_1.bMaxValueMinValueResetRequest	Maximum value/minimum value reset request	Y0D		
	R60ADG_1.uA_D_conversionCompletedFlag.0	A/D conversion completed flag	—		
	R60ADG_1.stnMonitor[0].wDigitalOutputValue	CH1 Digital output value	—		
	R60ADG_1.uA_D_conversionCompletedFlag.2	A/D conversion completed flag	—		
	R60ADG_1.stnMonitor[2].wDigitalOutputValue	CH3 Digital output value	—		
	R60ADG_1.uA_D_conversionCompletedFlag.4	A/D conversion completed flag	—		
	R60ADG_1.stnMonitor[4].wDigitalOperationValue	CH5 Digital operation value	—		
	R60ADG_1.uA_D_conversionCompletedFlag.6	A/D conversion completed flag	—		
	R60ADG_1.stnMonitor[6].wDigitalOutputValue	CH7 Digital output value	—		
	R60ADG_1.stnMonitor[4].wMaxValue	CH5 Maximum value	—		
	R60ADG_1.stnMonitor[4].wMinValue	CH5 Minimum value	—		
	R60ADG_1.uWarningOutputFlagProcessAlarmUpperLimit.2	Alert output flag (process alarm upper limit)	—		
	R60ADG_1.uWarningOutputFlagProcessAlarmLowerLimit.2	Alert output flag (process alarm lower limit)	—		
	R60ADG_1.uWarningOutputFlagRateAlarmUpperLimit.0	Alert output flag (rate alarm upper limit)	—		
	R60ADG_1.uWarningOutputFlagRateAlarmLowerLimit.0	Alert output flag (rate alarm lower limit)	—		
	R60ADG_1.uInputSignalErrorDetectionFlag.0	Input signal error detection flag	—		
	Labels to be defined	Define global labels as shown below:			
		Label Name	Data Type	Class	Assign (Device/Label)
1		DigitOutValSig	Bit	VAR_GLOBAL	X10
2		MaxMinReadSig	Bit	VAR_GLOBAL	X11
3		MaxMinResetSig	Bit	VAR_GLOBAL	X12
4		CH3_ProcAlmUpLimit	Bit	VAR_GLOBAL	F0
5		CH3_ProcAlmLowLimit	Bit	VAR_GLOBAL	F1
6		CH1_RateAlmUpLimit	Bit	VAR_GLOBAL	F2
7		CH1_RateAlmLowLimit	Bit	VAR_GLOBAL	F3
8		CH1_InputSigErr	Bit	VAR_GLOBAL	F4
9		ErrOperationEN	Bit	VAR_GLOBAL	
10		ErrResetSig	Bit	VAR_GLOBAL	X13
11		ErrOperationENO	Bit	VAR_GLOBAL	
12		ErrOperationOK	Bit	VAR_GLOBAL	
13		UnitErrFlg	Bit	VAR_GLOBAL	
14		CH1_DigOutVal	Word [Signed]	VAR_GLOBAL	D11
15		CH3_DigOutVal	Word [Signed]	VAR_GLOBAL	D12
16		CH5_DigcalcVal	Word [Signed]	VAR_GLOBAL	D13
17		CH7_DigOutVal	Word [Signed]	VAR_GLOBAL	D14
18		CH5_DigMaxVal	Word [Signed]	VAR_GLOBAL	D15
19		CH5_DigMinVal	Word [Signed]	VAR_GLOBAL	D16
20		UnitErrCode	Word [Unsigned]/Bit String [16-bit]	VAR_GLOBAL	
21		UnitAlarmCode	Word [Unsigned]/Bit String [16-bit]	VAR_GLOBAL	

Program examples

Program example 1

- This program is an example to read and save the digital output values of CH1, CH3, and CH7, and the digital operation value of CH5.

(0)	DigitOutValSig X10	R60ADG_1.bModuleREADY X0	R60ADG_1.bA_D_conversionCompletedFlag X0E	R60ADG_1.bOperatingConditionSettingRequest Y9	R60ADG_1.uA_D_conversionCompletedFlag,0	MOV	R60ADG_1.stnMonitor[0].wDigitalOutputValue	CH1_DigOutVal D11
					R60ADG_1.uA_D_conversionCompletedFlag,2	MOV	R60ADG_1.stnMonitor[2].wDigitalOutputValue	CH3_DigOutVal D12
					R60ADG_1.uA_D_conversionCompletedFlag,4	MOV	R60ADG_1.stnMonitor[4].wDigitalOperationValue	CH5_DigcalcVal D13
					R60ADG_1.uA_D_conversionCompletedFlag,6	MOV	R60ADG_1.stnMonitor[6].wDigitalOutputValue	CH7_DigOutVal D14
(28)								{END }

- (0) CH1 Digital output value, CH3 Digital output value, CH5 Digital operation value, and CH7 Digital output value are to be read.

Program example 2

- This program is an example to read the maximum and minimum values of CH5, which in turn are cleared.

(0)	MaxMinReadSig X11	R60ADG_1.bModuleREADY X0	R60ADG_1.bA_D_conversionCompletedFlag X0E	R60ADG_1.bOperatingConditionSettingRequest Y9	R60ADG_1.bMaxValueResetCompletedFlag X0D	MOV	R60ADG_1.stnMonitor[4].wMaxValue	CH5_DigMaxVal D15
						MOV	R60ADG_1.stnMonitor[4].wMinValue	CH5_DigMinVal D16
(12)	MaxMinResetSig X12					SET	R60ADG_1.bMaxValueMinValueResetRequest Y0D	
(15)	R60ADG_1.bMaxValueResetRequest Y0D	R60ADG_1.bMaxValueResetCompletedFlag X0D				RST	R60ADG_1.bMaxValueMinValueResetRequest Y0D	
(18)								{END }

- (0) CH5 Maximum value and CH5 Minimum value are to be read.
 (12) 'Maximum value/minimum value reset request' (YD) is to be turned on.
 (15) 'Maximum value/minimum value reset request' (YD) is to be turned off.

7 OFFSET/GAIN SETTING

Using the user range setting requires the offset/gain setting.

Access to the offset/gain setting window in the engineering tool to set the offset and gain values.

7.1 Setting Procedure

The setting procedure for the offset/gain setting of the A/D converter module is as follows:

[Tool] ⇒ [Module Tool List]

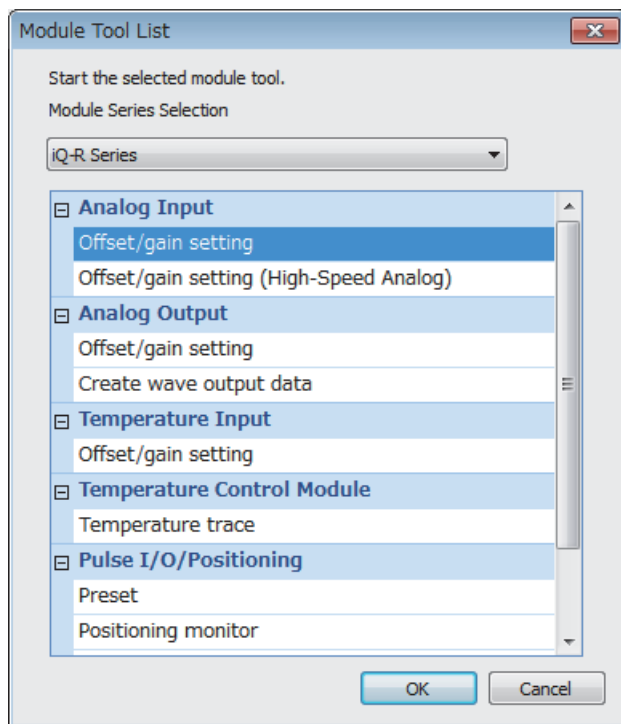

1. In "Analog Input", select "Offset/gain Setting" and click the [OK] button.

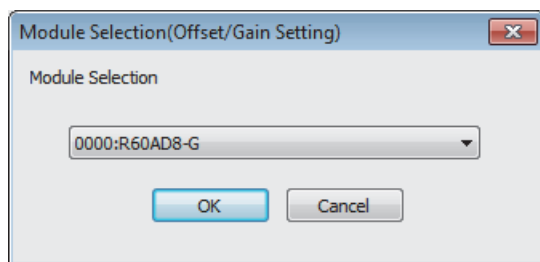

2. Select the target module for the offset/gain setting, and click the [OK] button.

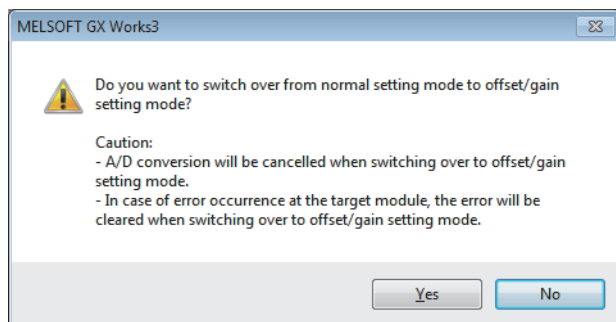

3. Click the [Yes] button.

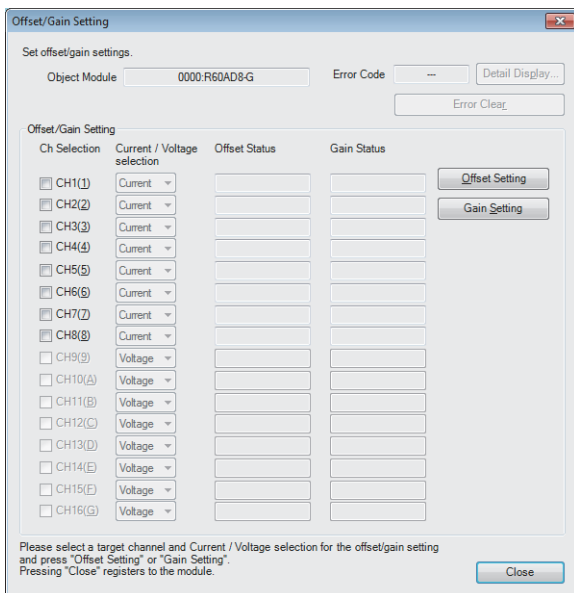

4. Mark the checkbox of the channel where offset and gain values are to be set.

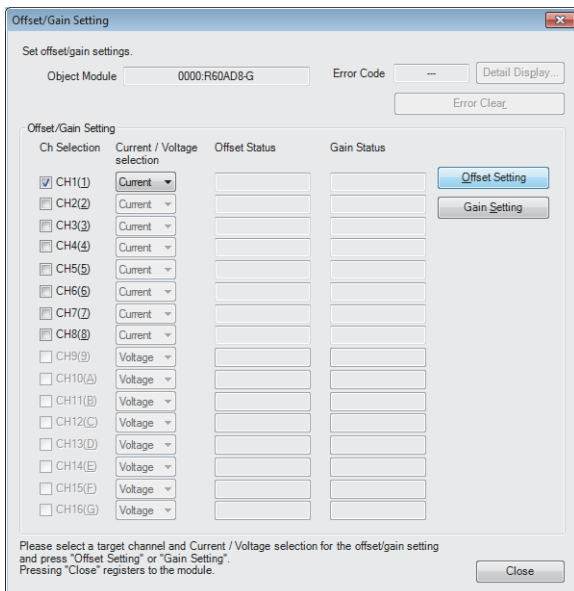

5. Select voltage or current and click the [Offset Setting] button.

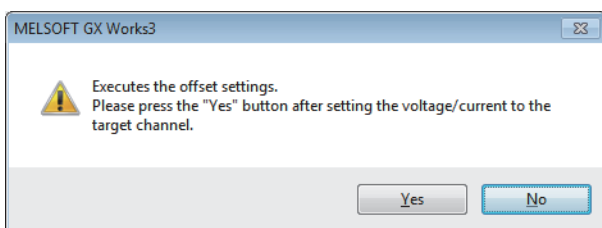

6. Apply the offset voltage or current to the corresponding channel, and click the [Yes] button.

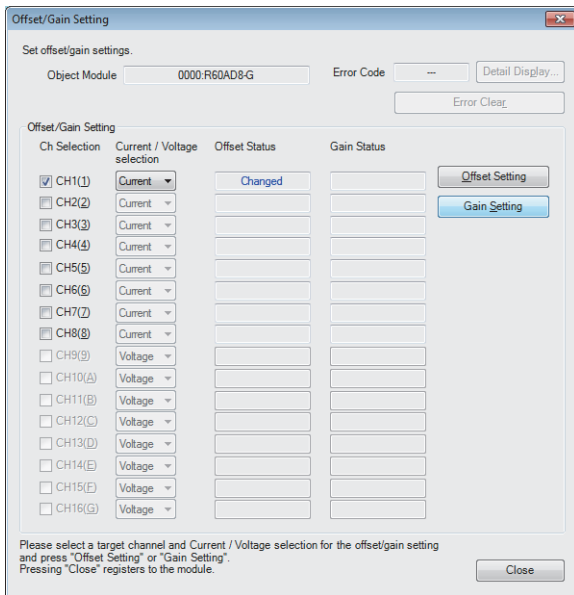

7. Check that "Offset Status" has changed to "Changed", and click the [Gain Setting] button.

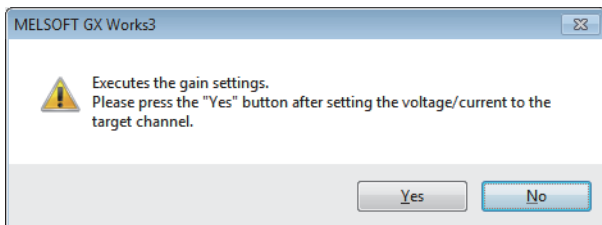

8. Apply the gain voltage or current to the corresponding channel, and click the [Yes] button.

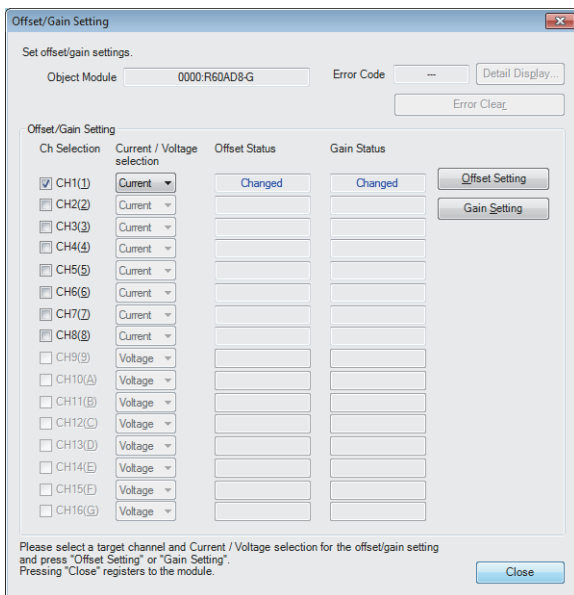

9. Check that "Gain Status" has changed to "Changed", and click the [Close] button.

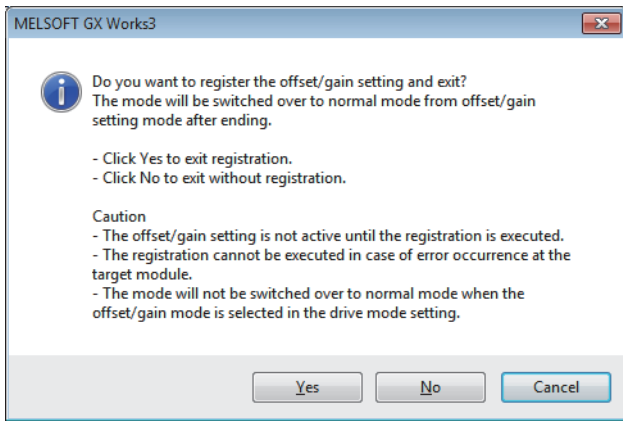

10. Click the [Yes] button.

APPENDICES

Appendix 1 I/O Conversion Characteristics

The I/O conversion characteristics of A/D conversion are expressed by the slope of the straight line connecting the offset value and the gain value, both of which are used when an analog signal (voltage or current) from outside the programmable controller is converted to the corresponding digital value.

Offset value

An analog input value (voltage or current) which turns 0 as a digital output value after conversion

Gain value

An analog input value (voltage or current) which turns 32000 as a digital output value after conversion

Voltage input characteristics

The following shows the list of analog input ranges at the voltage input and the graphs of each of the voltage input characteristics.

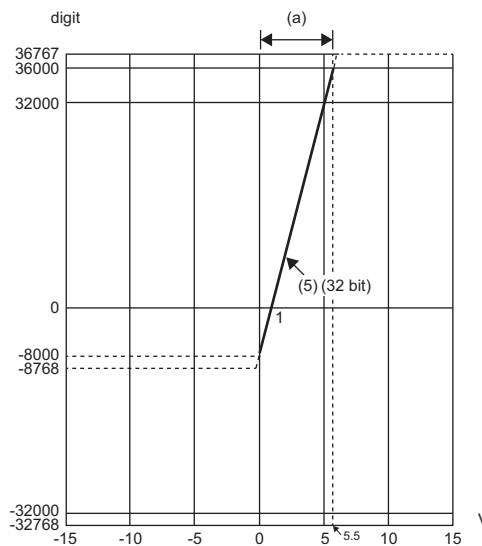
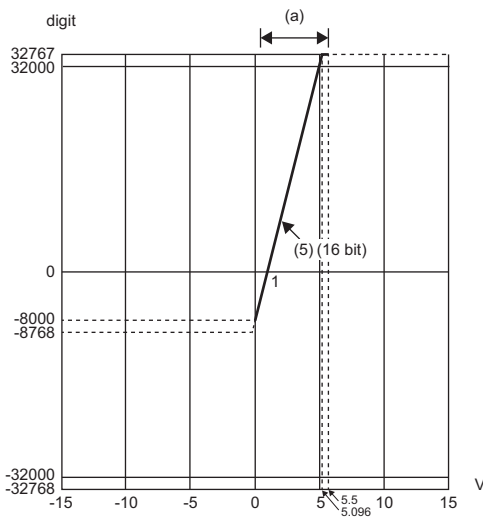
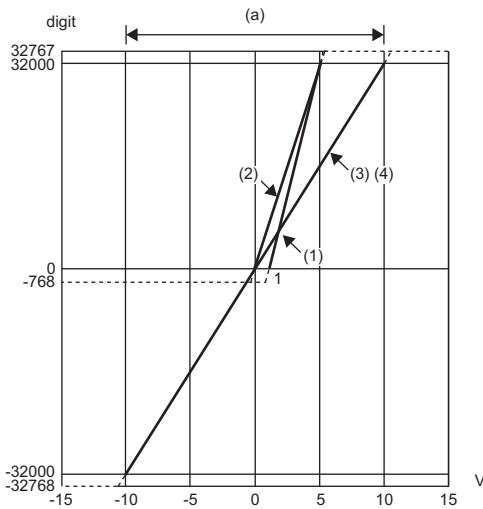

digit: Digital output value

V: Analog input voltage (V)

(5)(16bit): The line shows (5) for 16 bit.

(5)(32bit): The line shows (5) for 32 bit.

(a): Practical analog input range

No.	Input range setting	Offset value	Gain value	Digital output value ^{*3}	Resolution
(1)	1 to 5V	1V	5V	0 to 32000	125.0 μ V
(2)	0 to 5V	0V	5V		156.3 μ V
(3)	-10 to 10V	0V	10V	-32000 to 32000	312.5 μ V
(4)	0 to 10V	0V	10V	0 to 32000	
(5)	1 to 5V (extended mode)	1V	5V	-8000 to 36000	125.0 μ V
—	User range setting	*1	*1	-32000 to 32000	29.2 μ V ^{*2}

A

*1 Set the offset value and gain value in the user range setting within a range satisfying the following conditions. Failure to satisfy the conditions may not result in proper A/D conversion.

Setting range of the offset value and gain value: -10 to 10V

$$((\text{Gain value}) - (\text{Offset value})) \geq 1.6\text{V}$$

*2 Maximum resolution in the user range setting.

*3 If an analog input value exceeds the range of digital output value, the digital output value is fixed to the maximum or minimum value.

Input range setting	Digital output value	
	Minimum	Maximum
1 to 5V	-768	32767
0 to 5V		
-10 to 10V		
0 to 10V	-768	
1 to 5V (extended mode)	-8768	36767
User range setting	-32768	32767

Point 

- Set values within the practical range of the analog input and the digital output at each input range. If the range is exceeded, the resolution and accuracy may not fall within the range of the performance specifications. (Do not use the values in the dotted line region in the graph of voltage input characteristics.)
- Do not set the voltage over $\pm 15\text{V}$. Doing so can cause breakdown of the elements.

Current input characteristics

The following shows the list of analog input ranges at the current input and the graphs of each of the current input characteristics.

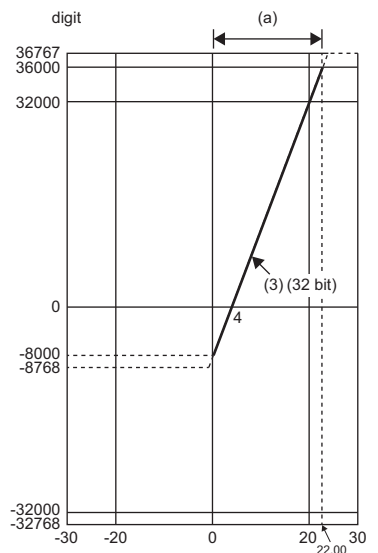
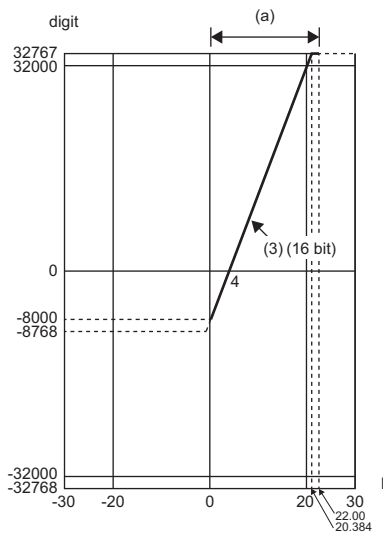
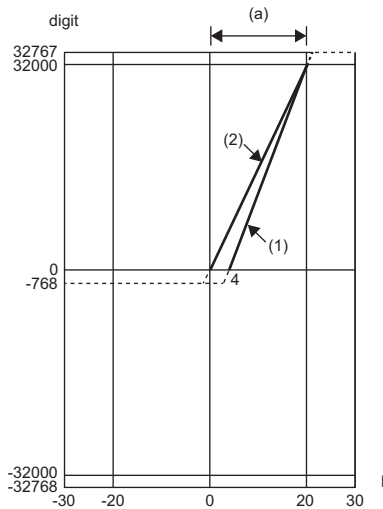

digit: Digital output value

I: Analog input current (mA)

(3)(16bit): (5) is a 16 bit of.

(3)(32bit): (5) is a 32 bit of.

(a): Practical analog input range

No.	Input range setting	Offset value	Gain value	Digital output value ^{*3}	Resolution
(1)	4 to 20mA	4mA	20mA	0 to 32000	500.0nA
(2)	0 to 20mA	0mA	20mA		625.0nA
(3)	4 to 20mA (extended mode)	4mA	20mA	-8000 to 36000	500.0nA
—	User range setting	*1	*1	-32000 to 32000	115.5nA ^{*2}

*1 Set the offset value and gain value in the user range setting within a range satisfying the following conditions. Failure to satisfy the conditions may not result in proper A/D conversion.

Gain value \leq 20mA, offset value \geq 0mA

$((\text{Gain value}) - (\text{Offset value})) \geq 12.2\text{mA}$

*2 Maximum resolution in the user range setting.

*3 If an analog input value exceeds the range of digital output value, the digital output value is fixed to the maximum or minimum value.

Input range setting	Digital output value	
	Minimum	Maximum
4 to 20mA	-768	32767
0 to 20mA		
4 to 20mA (extended mode)	-8768	36767
User range setting	-32768	32767

Point 

- Set values within the practical range of the analog input and the digital output at each input range. If the range is exceeded, the resolution and accuracy may not fall within the range of the performance specifications. (Do not use the values in the dotted line region in the graph of current input characteristics.)
- Do not set the voltage over $\pm 30\text{mA}$. Doing so can cause breakdown of the elements.

Appendix 2 Accuracy

The accuracy of A/D conversion is the accuracy for the maximum value of digital output value. The accuracy is given by the following formula:

$$\text{Accuracy} = (\text{Reference accuracy}) + (\text{Temperature coefficient}) \times (\text{Temperature variation})$$

- Reference accuracy: The accuracy at an ambient temperature when the offset/gain setting is configured. ($\pm 0.1\%$ (± 32 digit))
- Temperature coefficient: The accuracy based on a temperature change of 1°C . ($0.0035\%/^\circ\text{C}$ (± 1.12 digit))

An output characteristic change resulting from a change in the offset/gain setting or the analog input range does not sacrifice the reference accuracy and temperature coefficient, which are maintained within the described range of the performance specifications

(except for the conditions under noise influence).

Ex.

Accuracy when the temperature changes by 5°C from 25°C to 30°C

$$(\pm 0.1\%) + (\pm 0.0035\%/^\circ\text{C} \times 5^\circ\text{C}) = \pm 0.1175\% (\pm 38 \text{ digit})$$

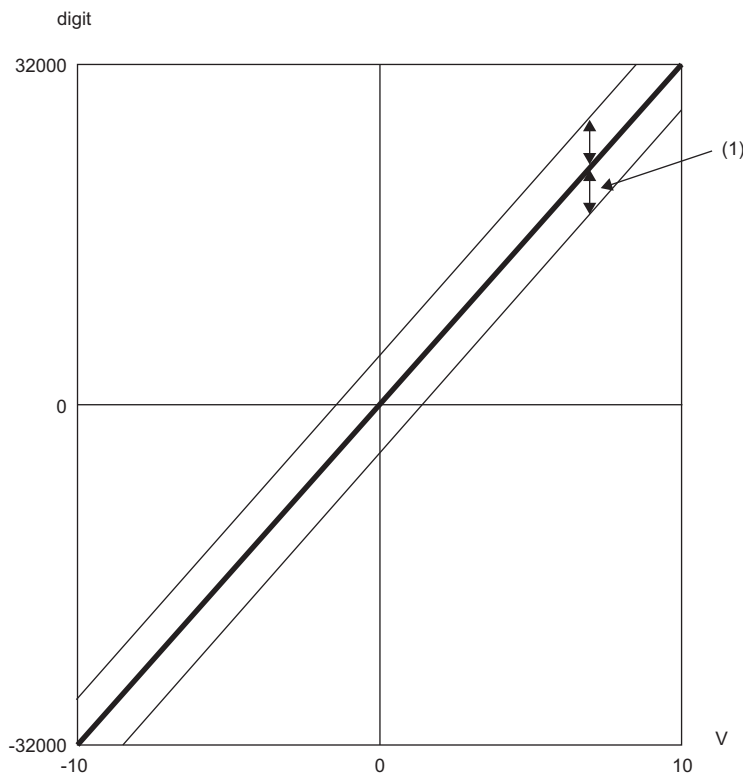

digit: Digital output value

V: Analog input voltage (V)

(1) Voltage fluctuation range



Appendix 3 External Dimensions

The following figure shows the external dimensions of the A/D converter module.

R60AD8-G

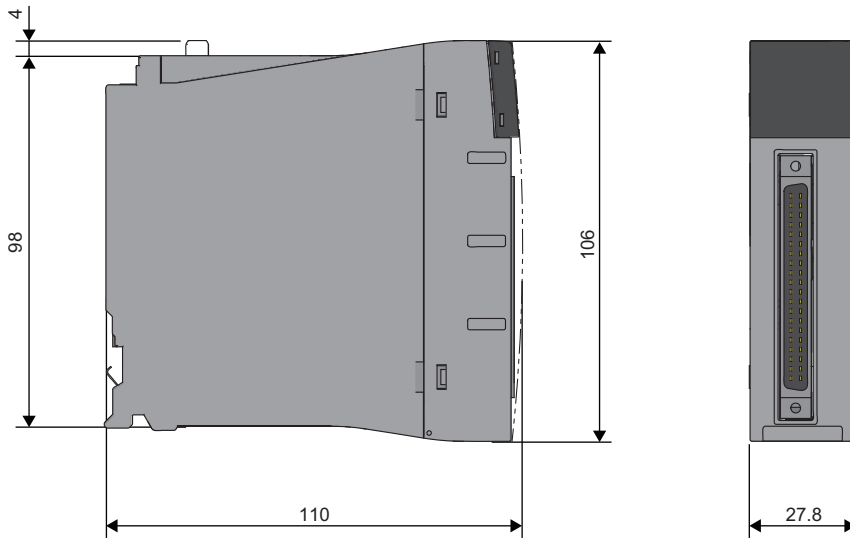

(Unit: mm)

R60AD16-G

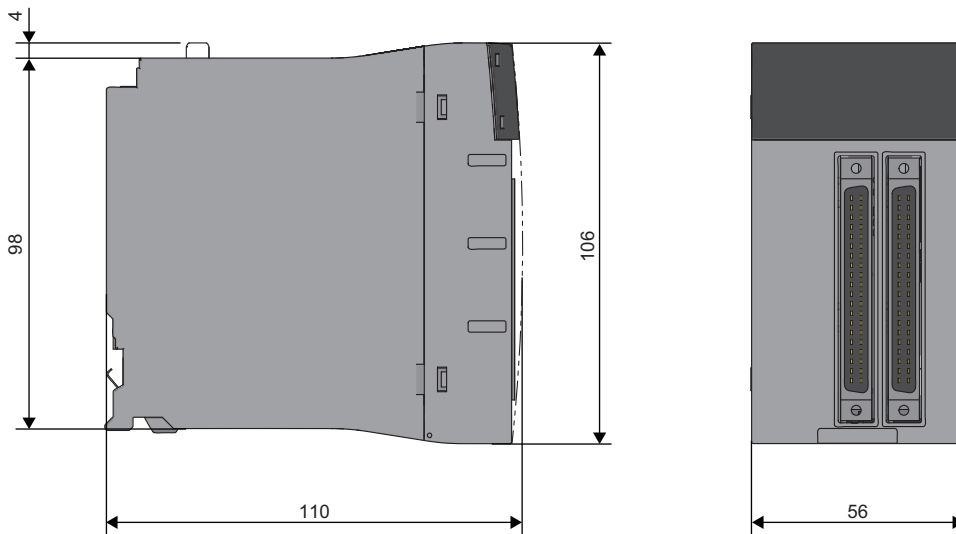

(Unit: mm)

MEMO

A

INDEX

A

Accuracy of A/D conversion	41
ALM LED	14

C

Connector for external devices	22
Connector/terminal block converter module	25
Current input characteristics	39

D

Dedicated cable	25
---------------------------	----

E

ERR LED	14
External dimensions	42
External wiring	23

F

Function block (FB)	26
-------------------------------	----

G

Gain value	36
----------------------	----

O

Offset value	36
Offset/gain setting	32

P

Performance specifications	16
--------------------------------------	----

R

RUN LED	14
-------------------	----

V

Voltage input characteristics	37
---	----

MEMO

REVISIONS

*The manual number is given on the bottom left of the back cover.

Revision date	*Manual number	Description
January 2015	SH(NA)-081485ENG-A	First edition
March 2016	SH(NA)-081485ENG-B	■Added or modified parts RELEVANT MANUALS, Section 5.2, 7.1, Appendix 1, 2, 3

Japanese manual number: SH-081484-B

This manual confers no industrial property rights of any other kind, nor does it confer any patent licenses. Mitsubishi Electric Corporation cannot be held responsible for any problems involving industrial property rights which may occur as a result of using the contents noted in this manual.

© 2015 MITSUBISHI ELECTRIC CORPORATION

WARRANTY

Please confirm the following product warranty details before using this product.

1. Gratis Warranty Term and Gratis Warranty Range

If any faults or defects (hereinafter "Failure") found to be the responsibility of Mitsubishi occurs during use of the product within the gratis warranty term, the product shall be repaired at no cost via the sales representative or Mitsubishi Service Company.

However, if repairs are required onsite at domestic or overseas location, expenses to send an engineer will be solely at the customer's discretion. Mitsubishi shall not be held responsible for any re-commissioning, maintenance, or testing on-site that involves replacement of the failed module.

[Gratis Warranty Term]

The gratis warranty term of the product shall be for one year after the date of purchase or delivery to a designated place. Note that after manufacture and shipment from Mitsubishi, the maximum distribution period shall be six (6) months, and the longest gratis warranty term after manufacturing shall be eighteen (18) months. The gratis warranty term of repair parts shall not exceed the gratis warranty term before repairs.

[Gratis Warranty Range]

- (1) The range shall be limited to normal use within the usage state, usage methods and usage environment, etc., which follow the conditions and precautions, etc., given in the instruction manual, user's manual and caution labels on the product.
- (2) Even within the gratis warranty term, repairs shall be charged for in the following cases.
 1. Failure occurring from inappropriate storage or handling, carelessness or negligence by the user. Failure caused by the user's hardware or software design.
 2. Failure caused by unapproved modifications, etc., to the product by the user.
 3. When the Mitsubishi product is assembled into a user's device, Failure that could have been avoided if functions or structures, judged as necessary in the legal safety measures the user's device is subject to or as necessary by industry standards, had been provided.
 4. Failure that could have been avoided if consumable parts (battery, backlight, fuse, etc.) designated in the instruction manual had been correctly serviced or replaced.
 5. Failure caused by external irresistible forces such as fires or abnormal voltages, and Failure caused by force majeure such as earthquakes, lightning, wind and water damage.
 6. Failure caused by reasons unpredictable by scientific technology standards at time of shipment from Mitsubishi.
 7. Any other failure found not to be the responsibility of Mitsubishi or that admitted not to be so by the user.

2. Onerous repair term after discontinuation of production

- (1) Mitsubishi shall accept onerous product repairs for seven (7) years after production of the product is discontinued. Discontinuation of production shall be notified with Mitsubishi Technical Bulletins, etc.
- (2) Product supply (including repair parts) is not available after production is discontinued.

3. Overseas service

Overseas, repairs shall be accepted by Mitsubishi's local overseas FA Center. Note that the repair conditions at each FA Center may differ.

4. Exclusion of loss in opportunity and secondary loss from warranty liability

Regardless of the gratis warranty term, Mitsubishi shall not be liable for compensation to:

- (1) Damages caused by any cause found not to be the responsibility of Mitsubishi.
- (2) Loss in opportunity, lost profits incurred to the user by Failures of Mitsubishi products.
- (3) Special damages and secondary damages whether foreseeable or not, compensation for accidents, and compensation for damages to products other than Mitsubishi products.
- (4) Replacement by the user, maintenance of on-site equipment, start-up test run and other tasks.

5. Changes in product specifications

The specifications given in the catalogs, manuals or technical documents are subject to change without prior notice.

TRADEMARKS

The company names, system names and product names mentioned in this manual are either registered trademarks or trademarks of their respective companies.

In some cases, trademark symbols such as [™] or [®] are not specified in this manual.

SH(NA)-081485ENG-B(1603)MEE

MODEL: R-AD-G-U-IN-E

MODEL CODE: 13JX29

MITSUBISHI ELECTRIC CORPORATION

HEAD OFFICE : TOKYO BUILDING, 2-7-3 MARUNOUCHI, CHIYODA-KU, TOKYO 100-8310, JAPAN
NAGOYA WORKS : 1-14, YADA-MINAMI 5-CHOME, HIGASHI-KU, NAGOYA, JAPAN

When exported from Japan, this manual does not require application to the
Ministry of Economy, Trade and Industry for service transaction permission.

Specifications subject to change without notice.