

Programmable Controllers
MELSEC-Q series [QnU]

Reaching higher, to the summit of the Q Series



MELSEC  **series**

Performance on a different level brought to you
with the Programmable Controller

Continuously evolving Universal Model



Current production requirements are calling for an increase in productivity and carrying out production processes even faster due to an increase in production information such as production results and traceability. The MELSEC-Q Series programmable controller "Universal model QnU" is a leader for these market needs. High-speed basic instruction processing on a micro scale dramatically increases your system and machine performance.

Inheriting the high robust and ease of use design of the Q Series, the MELSEC QnU programmable controller will open up new possibilities in automation solutions.

High-speed
1.9 ns

Large capacity
1000K
steps

Built-in
Ethernet

Built-in
USB

SD
memory card
slot

Security

Data
logging
function

MELSEC  series

QnU



Improved Productivity

More User - Friendly

Easy Maintenance



Customer experiences created this programmable controller

- Support for shorter operation cycle times
- Support for higher quality control requirements
- Complex and large-scale equipment and systems
- Expanding control and production control data
- Shorter product cycles
- Support for higher equipment operation rates

I N D E X

QnU CPU.....	P.3	Module Lineup.....	P.33
• Improved Productivity.....	P.5	Software.....	P.47
• More User-Friendly.....	P.9	Related Products.....	P.57
• Easy Maintenance.....	P.15	Specifications.....	P.66
CPU Lineup.....	P.17	Support.....	P.74
Network.....	P.21	Product List.....	P.77

Reaching higher, to the summit of the Q Series

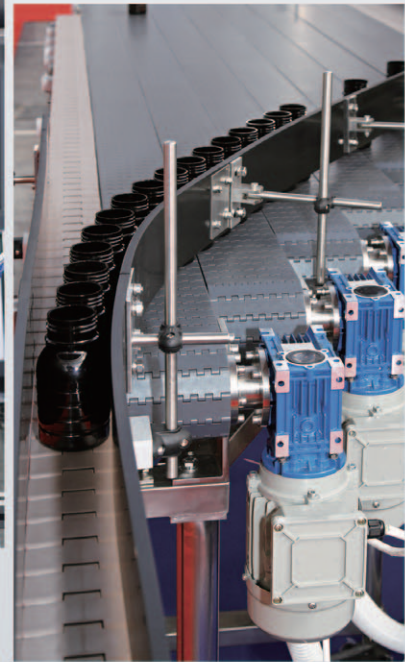
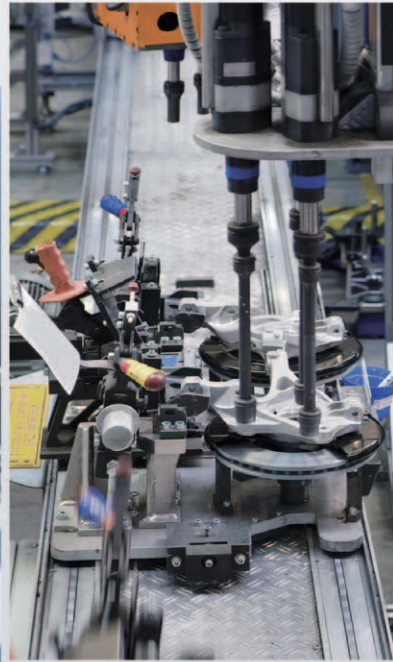

■ MELSEC-Q Series Universal model lineup

Program capacity (step)

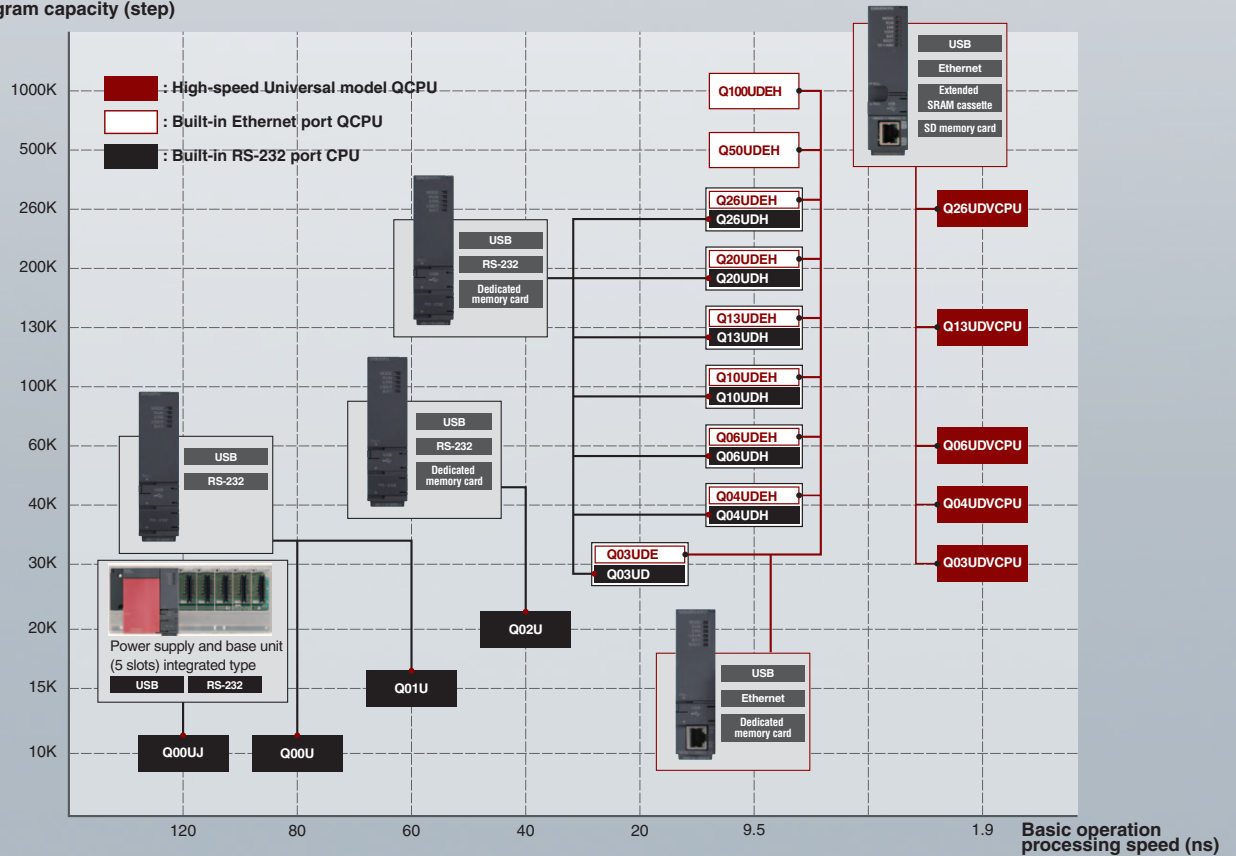



High-speed Universal model QCPU

Q03UDV, Q04UDV, Q06UDV, Q13UDV, Q26UDV

Basic operation processing speed (LD instruction) 1.9 ns	Program capacity 260K steps		
Ethernet	USB	SD memory card slot	Extended SRAM cassette
Data logging function	Security		

*: This CPU type is only supported by GX Works2 (not supported by GX Developer).

■ High-speed Universal model QCPU

SD memory card slot

- ▶ Data logging function
- ▶ Boot operation
- ▶ Backup/Restore



CPU

- ▶ Basic operation processing speed (LD instruction): 1.9 ns
- ▶ Program capacity: maximum 260K steps
- ▶ Fixed Scan interrupt program (minimum interval): 100 μs



Ethernet port



USB port

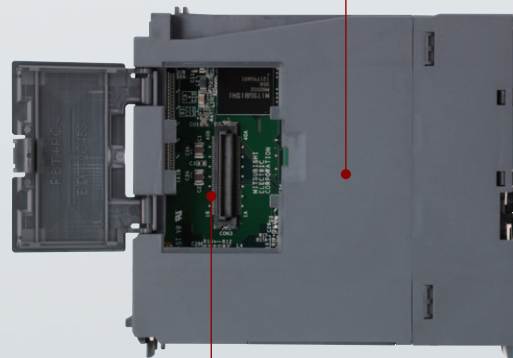

Cassette port

- ▶ Expand standard RAM (up to 8 MB)
- ▶ Use simultaneously with SD memory card
- ▶ Continuously access file registers

Enhanced security functions

Maximum of 32 character password is supported.
A mix of alphanumeric and special characters (*, @, and & etc.) can be used further strengthening the security of the password.
In addition, protection of intellectual property can be enhanced by blocking any unauthorized devices and only allowing registered devices to access the CPU.



Improved Productivity



Basic operation processing speed (LD instruction):

1.9 ns

Q03UDV, Q04UDV, Q06UDV, Q13UDV, Q26UDV

High-speed, high-accuracy machine control

To achieve high-speed synchronized control between multiple CPUs, a dedicated bus is used, independent of sequence program operation. (0.88 ms operation cycle)*1

This multiple CPU high-speed communication is synchronized with motion control to maximize efficiency. Additionally, the performance of the motion control CPU is twice as fast as the previous model, ensuring high-speed, high-accuracy machine control.

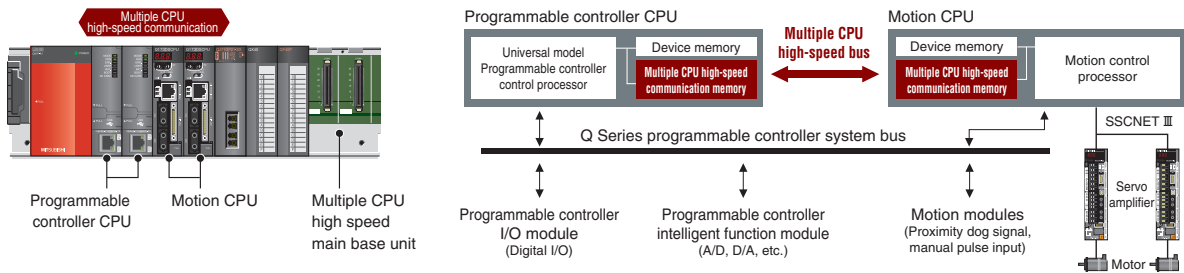

In-position response time

Fast in-position response time is realized between the motion CPU and programmable controller. The in-position signal is triggered by the servo amplifier of the first axis, with the time taken between the second axis at start-up and the speed command output of the programmable controller CPU.

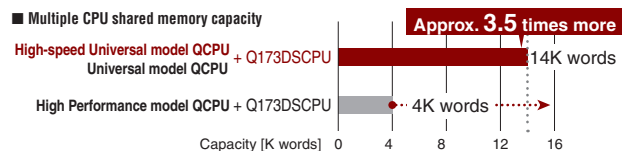
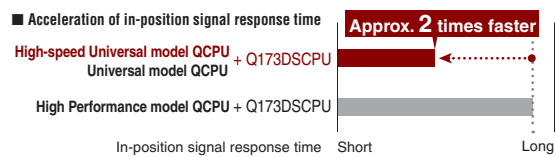
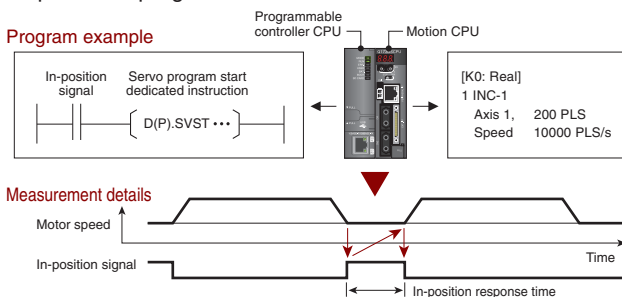

*1: Q00UJ, Q00U, Q01U and Q02U are not supported.

■ Improved production time with ultra-high-speed processing Improved performance!

As applications are getting larger and more complex it is essential to shorten the system operation cycle time. To achieve this, the ultra high-speed of 1.9 ns (LD instruction) processing enables to realize shorter operating cycles.

System performance can be improved by reducing the overall scan time, preventing any variances in performance. In addition to realization of high-speed control which is normally associated with microcomputer control.

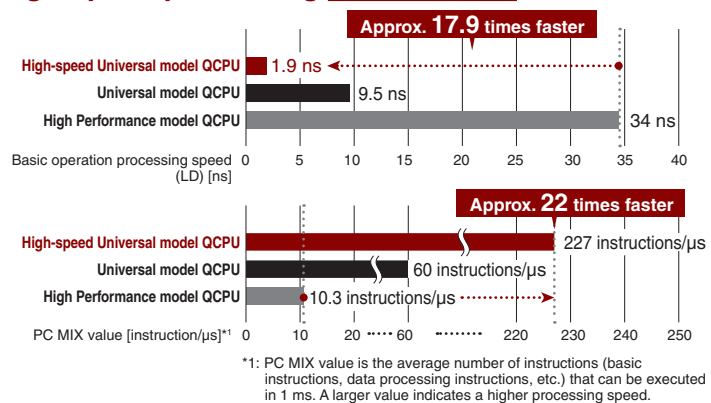

■ High-speed, high-precision data processing Improved performance!

The floating point addition processing speed has been increased to 0.014 μs to support high-speed, high-precision operation processing. Also, double-precision floating-point operation instruction is included to simplify programming and reduce calculation errors when implementing complex equations.

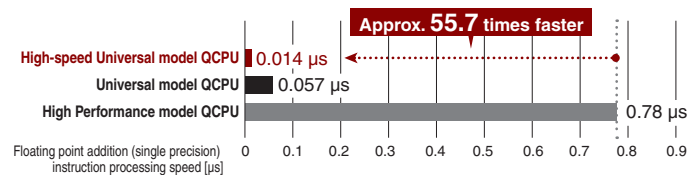

CPU	Addition (E+)	
	Single precision [μs]*2	Double precision [μs]*2
High-speed Universal model QCPU	0.014	1.8
Universal model QCPU	0.057	4.3
High Performance model QCPU	0.78	87*3

*2: Minimum value *3: Indicates internal double-precision operation processing speed.

■ Shorter fixed scan interrupt time realizing higher system accuracy Improved performance!

Reduced minimal fixed scan interrupt program time to 100 μs*4.
High-speed I/O signals resulting in high-accuracy control system.

Example: High-speed position detection of film paper feed system

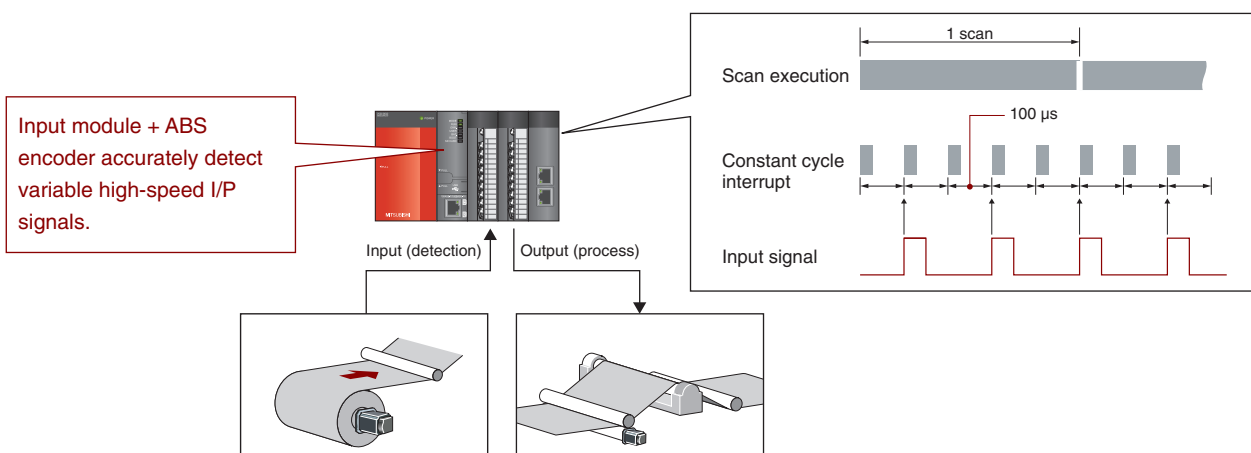

*4: Only supported by High-speed Universal model QCPU.

Improved Productivity

■ Improved basic functions Improved performance!

The CPU's built-in device memory capacity has been increased to a max. of 60K words*1. Support increasing control and quality data with high-speed processing.

Increased capacity!

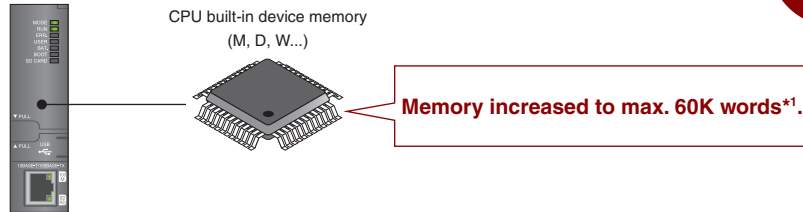

*1: Only for Q13UDVCPU and Q26UDVCPU.

■ Large data volume at high-speed Improved performance!

Conventionally, continuous access to the standard RAM and SRAM card's file register area could not be achieved which had to be reflected in the user program.

When an 8 MB extended SRAM cassette is installed in the High-speed Universal model QCPU, the standard RAM can be as one continuous file register with up to 4736K words capacity, simplifying the user program.

Even if the device memory is insufficient, the file register area can be expanded easily by installing the extended SRAM cassette.

Continuous access! *2

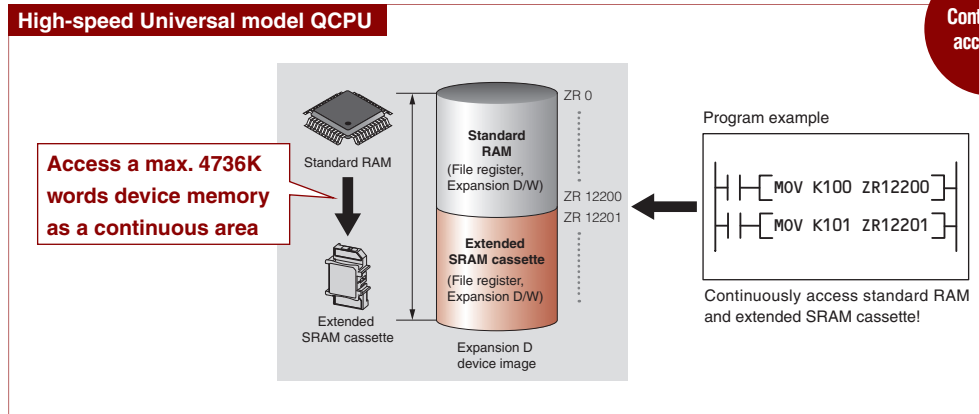

*2: Only supported by High-speed Universal model QCPU.

© File register capacity*3

Model	Q03UDV	Q04UDV	Q06UDV	Q13UDV	Q26UDV
Extended SRAM cassette not installed (Standard RAM capacity)	96K words (192 KB)	128K words (256 KB)	384K words (768 KB)	512K words (1024 KB)	640K words (1280 KB)
with Q4MCA-1MBS (1 MB)*4	608K words	640K words	896K words	1024K words	1152K words
with Q4MCA-2MBS (2 MB)*4	1120K words	1152K words	1408K words	1536K words	1664K words
with Q4MCA-4MBS (4 MB)*4	2144K words	2176K words	2432K words	2560K words	2688K words
with Q4MCA-8MBS (8 MB)*4	4192K words	4224K words	4480K words	4608K words	4736K words

*3: Maximum capacity when using extended SRAM cassette file as a file register. Total when CPU's standard RAM and extended SRAM cassette are installed.

*4: Only High-speed Universal model QCPU.

The index register has been extended to 32 bits to allow programming beyond the conventional 32K words and to enable use of the entire file register area.

The processing speed for indexing, which is essential for efficient operation of structured (array) data, has been increased. The scan time can be shortened when indexing is used in repetitive programs, such as FOR to NEXT instructions.

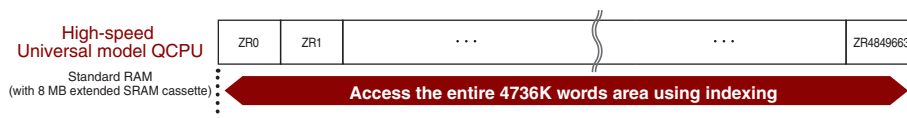

■ **SD memory card** Improved functionality!

SD memory card is supported by High-speed Universal model QCPU allowing easy data exchange with a personal computer. The SD memory card and extended SRAM cassette can be used at the same time allowing extension of file registers (with extended SRAM cassette), data file logging, boot data, and storing of large comment data (SD memory card).

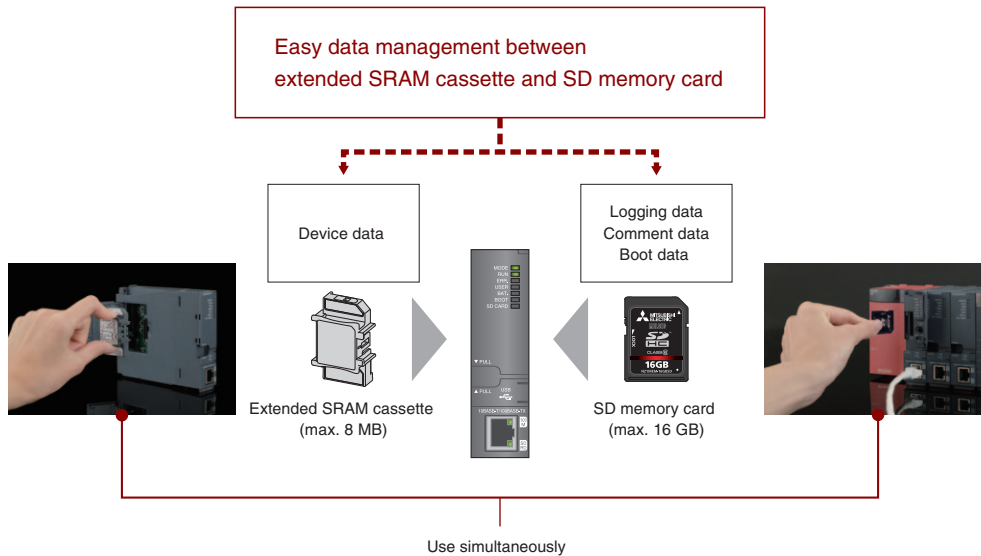

■ **Protect important data with enhanced security** Improved functionality!

A max. 32-character file password can be set*1.
Special characters (*, @, &, etc.) can be used in addition to alphanumeric characters making it harder to compromise the password.

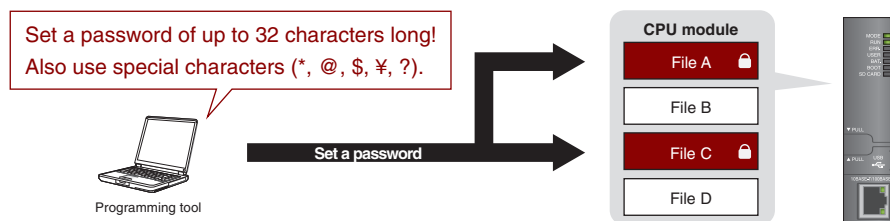

Also protection of valuable intellectual property can be enhanced by only allowing preregistered devices to access the CPU, blocking out unauthorized users*2.

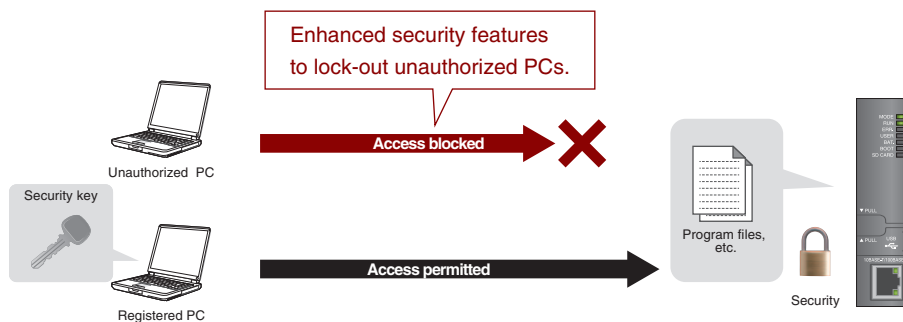

*1: Only supported by High-speed Universal model QCPU. Other models use 4 character password system.
*2: Only supported by High-speed Universal model QCPU.



Display collected data on PC or GOT (HMI)

More User-Friendly

Data logging function Improved functionality!

Q03UDV, Q04UDV, Q06UDV, Q13UDV, Q26UDV

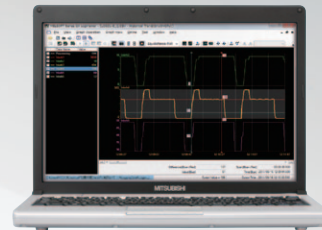

Logging data display and analysis tool
GX LogViewer

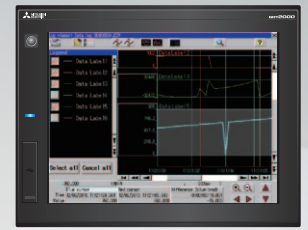

GOT log viewer function

■ Easy logging without a program

Save collected data in CSV format on a SD memory card just by completing easy settings with the dedicated setting tool wizard. Various reference materials including daily reports, form creation and general reports can be created easily within the saved CSV file. This data can be used for a wide variety of applications requiring traceability, production data, etc.

■ Setting with Wizard screen

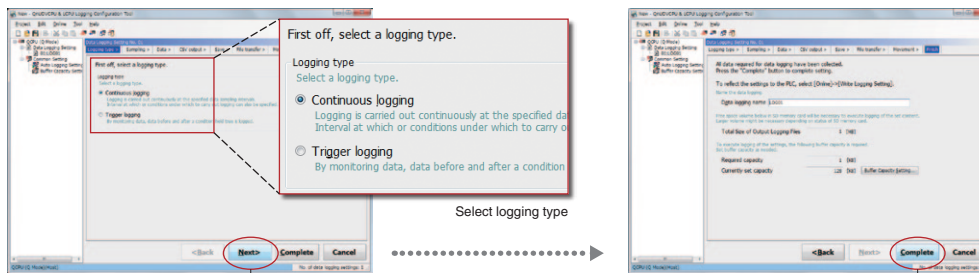

Enter settings according to the wizard.
Click "Next" button to complete!

■ Logging of control data variances

Data is collected during each scan or within millisecond intervals allowing detection of control deviation even at very high speeds. Therefore, identification of errors can be conducted faster and in more detail.

■ Generic sample data from a PC or external device at 100 ms intervals

■ Q Series CPU data logging function is capable of sampling data at much higher intervals as to detect fast changing values.

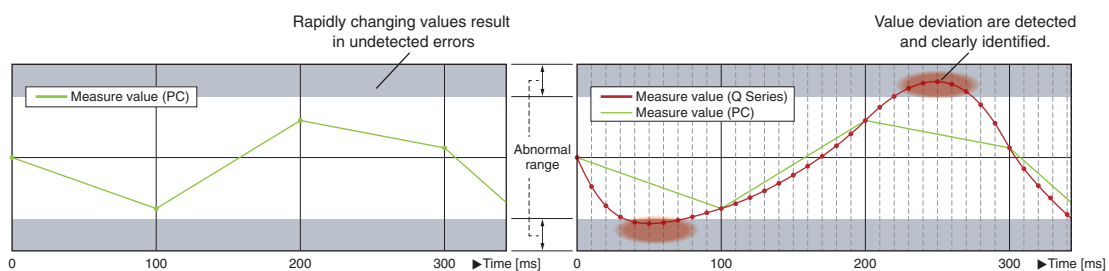

■ Automatic logging just by using a SD memory card

Automatic data logging realized just by inserting the SD memory card into the CPU, which is achieved as the memory card includes the logging configuration file. Instructing data logging remotely is also realized just by sending the configuration file by e-mail and copying onto the SD memory card.

Example: Quickly setup for automatic data logging on-site

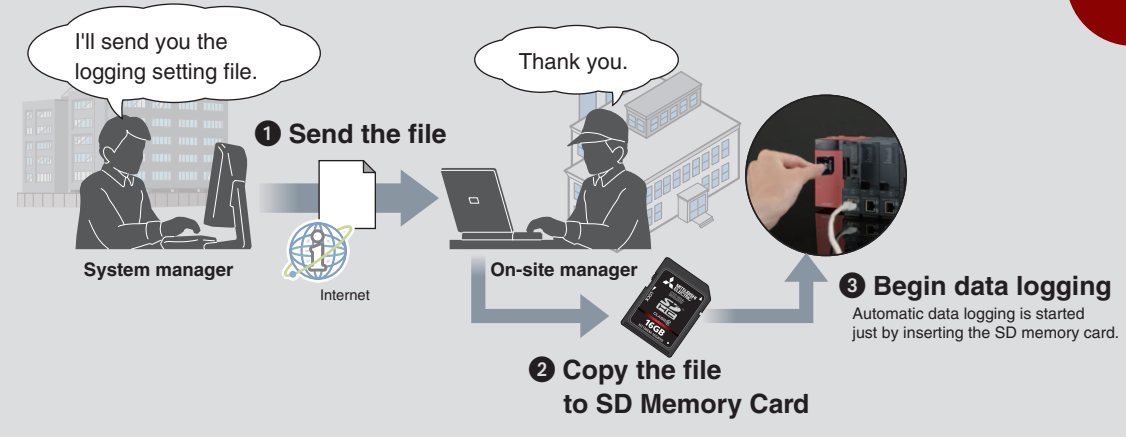

■ Automatically send logging files to FTP server

Data logging files stored on the SD memory card can be sent to FTP server just by making a simple setting with the Logging configuration tool. As the logging server can handle multiple files, management and maintenance tasks can be reduced.

■ File transfer feature

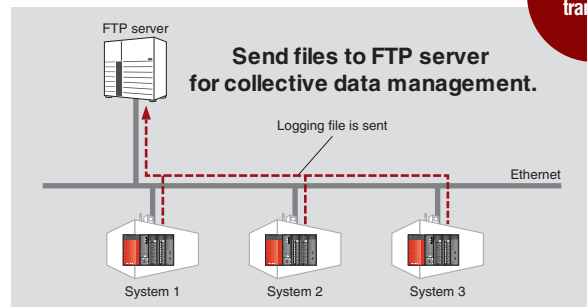

■ Quick troubleshooting response

Error causes and solutions can be quickly done as only the required data related to the problem is extracted, without having to spend time on filtering large volumes of diagnostic data.

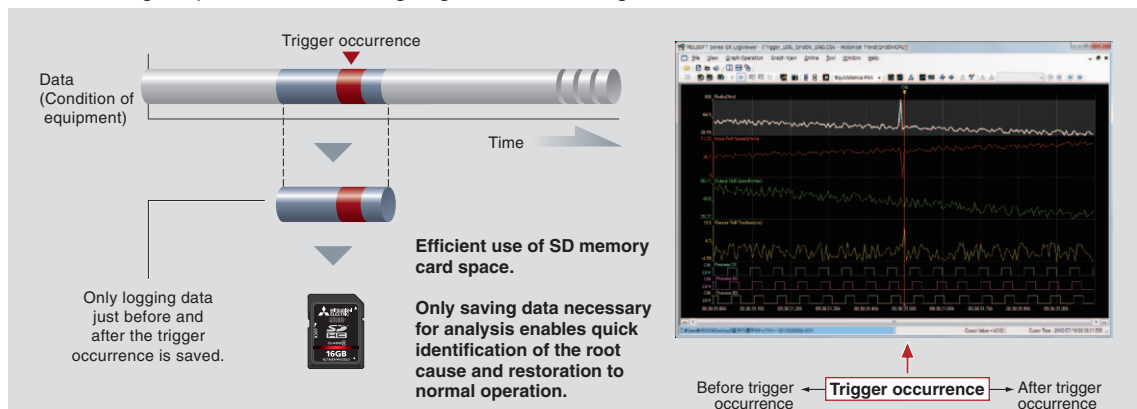

“GX LogViewer*1” and “Logging configuration tool*2” available for free

To obtain a copy of GX LogViewer and Logging configuration tool, please contact your local Mitsubishi Electric representative.

*1: Refer to page 55 for details on GX LogViewer.
*2: The logging configuration tool is enclosed with GX Works2.

More User-Friendly

CPU modules with Built-in Ethernet Port

Q03UDV, Q04UDV, Q06UDV, Q13UDV, Q26UDV

Q03UDE, Q04UDEH, Q06UDEH, Q10UDEH, Q13UDEH, Q20UDEH, Q26UDEH, Q50UDEH, Q100UDEH

■ Easily connect to CPUs via Ethernet

IP address settings are not required to connect to CPU modules directly (one-to-one connection) using GX Works2 or GX Developer. Both straight and cross cables can be used, and are automatically identified by the CPU module. Therefore this connection method is as easy as using USB. Even operators who are not familiar with network settings can easily establish a connection.

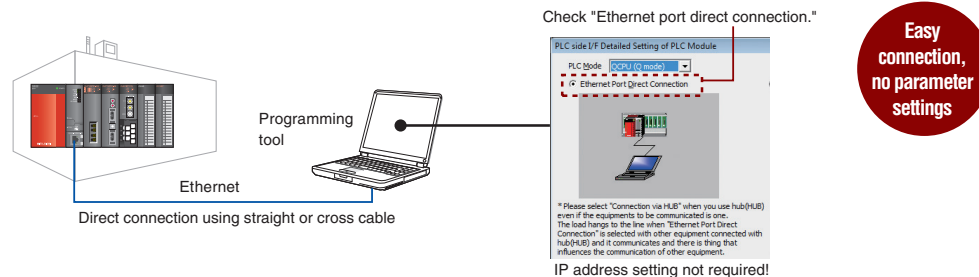

■ Search and display a list of connected CPUs

When multiple CPUs are connected via an Ethernet hub, GX Developer or GX Works2 can search for and display a list of all connected CPUs. This allows the user to quickly and easily find the correct station even if the IP address is unknown. Then programming and maintenance functions can be performed without wasting any time.

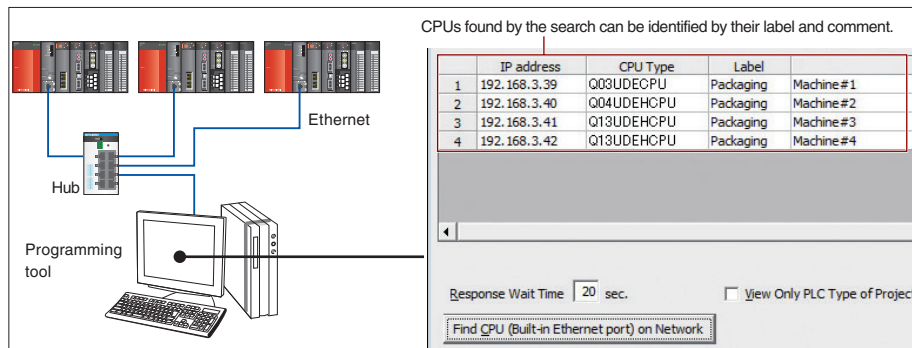

■ Easily connect to BACnet™ and MODBUS®/TCP Improved function

Ethernet realizes a high-speed connection, such as communication with external devices. By using predefined protocol support function*1, various devices that require open network protocol support, such as BACnet™ and MODBUS®/TCP are supported.

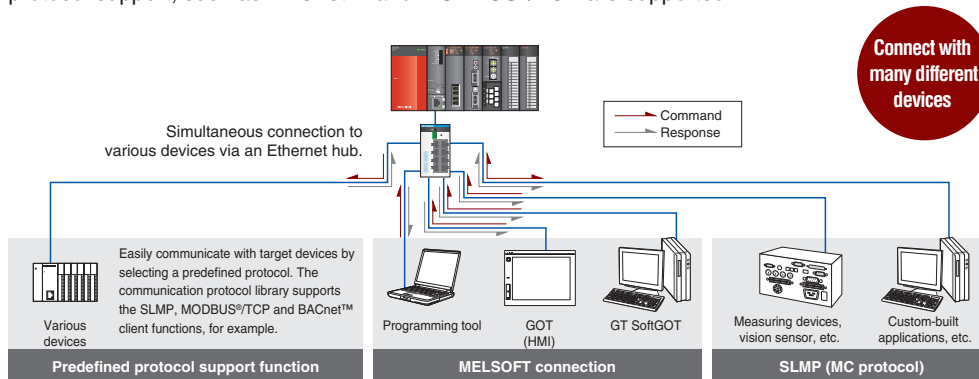

*1: Only supported by High-speed Universal model QCPU.

Seamless communication across all layers

The Universal model QCPUs support a multitude of networking technologies including the high-speed, high-capacity CC-Link IE Control Network and CC-Link IE Field Network. Along with MELSECNET/H, Ethernet, and CC-Link, these networks may be accessed seamlessly beyond network type or hierarchy. Each programmable controller on the network can be accessed for programming and maintenance duties by using a personal computer with the appropriate engineering tools connected via Ethernet.

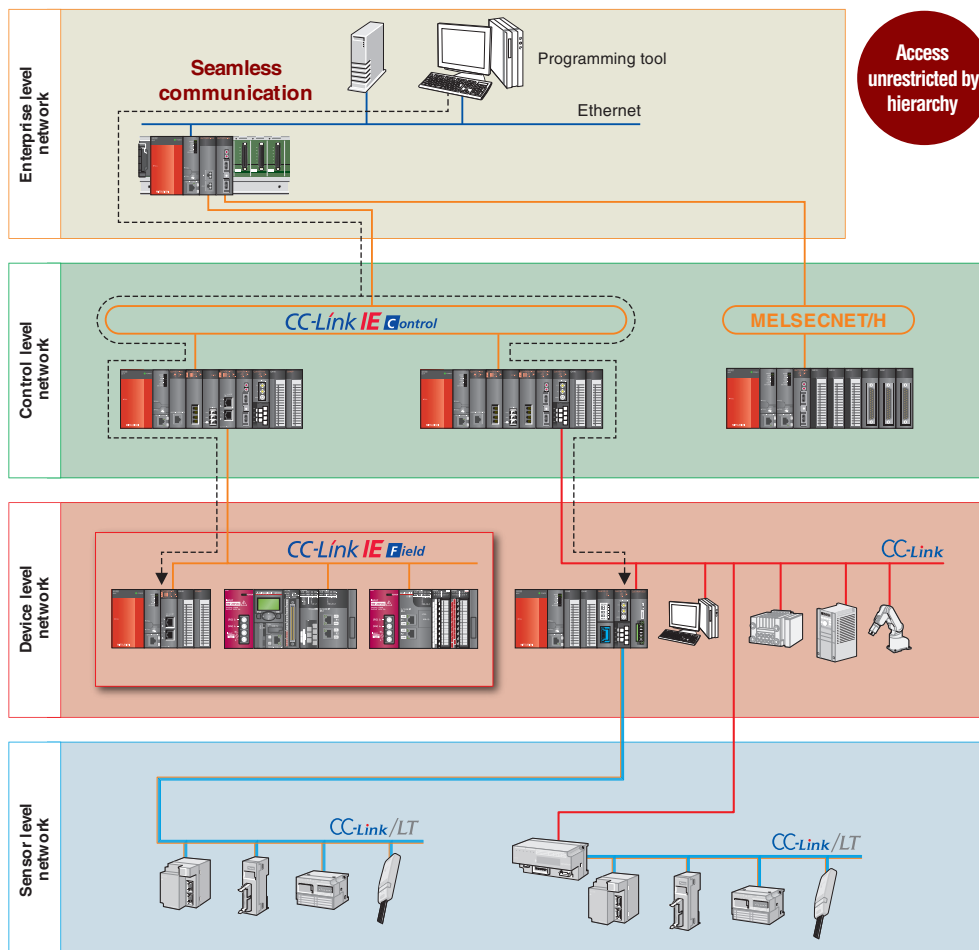

Accurate clock data

The CPU module's clock is automatically corrected with the SNTP*1 clock synchronization function. When CPU clock data is reliably synchronized between systems, any time-stamped events or errors that involve more than one CPU can be easily understood in terms of their order of occurrence and relationship.

*1: SNTP Simple Network Time Protocol

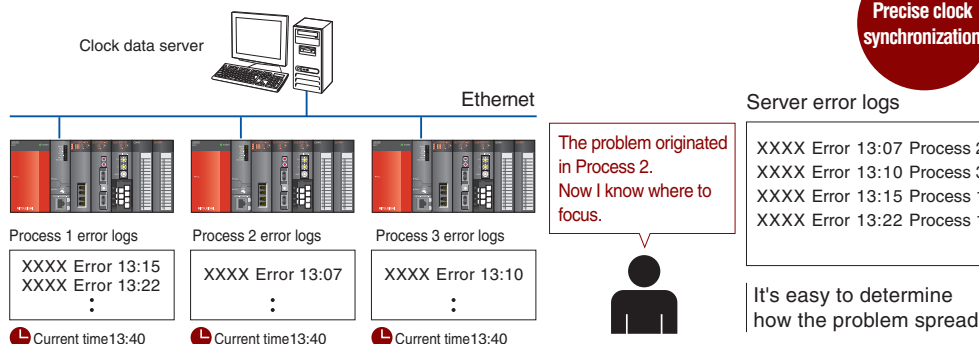

More User-Friendly

■ Save valuable time using the sampling trace function*1

The sampling trace function is a useful diagnostic tool for analyzing error data, and sequence of events for program debug, etc. It can help reduce the overall time required for startup and commissioning of equipment.

In the multiple CPU configuration it can help to determine the timing and transfer of data between CPU modules. Collected data can be easily analyzed within the programming software tool with differences in word device and bit device values conveniently shown in chart and graph form.

In addition, the results from sampling trace can be exported to GX LogViewer CSV file format for analysis within the software.

Sampling trace execution condition settings

Configure how much data to capture

Configure when to capture the data

Configuring data collection is simple

Sampling Trace window: example results

Chart

Trend graph

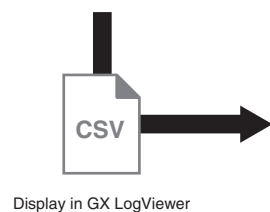

GX LogViewer screen

*1: Not supported by Q00UJ.

■ Simplify the debugging process

Universal model CPUs have the ability to use the "Executorial conditioned device test" function, which automatically sets device values to user specified values at any step during program simulation. Traditionally, to simulate real I/O or other device value change, a separate program would need to be written to perform debugging. By using the "Executorial conditioned device test" function, it is possible to debug even small portions of simple ladder programs without the need to modify the program or add rungs of ladder. Therefore, debugging can be completed faster and easier.

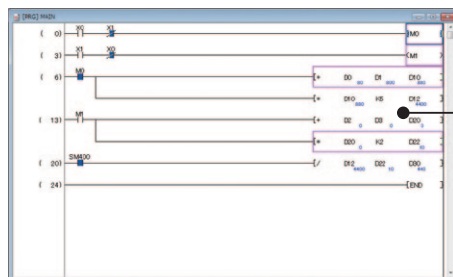

Devices that have been added to the executorial conditioned device test are highlighted by a pink box for easy identification.

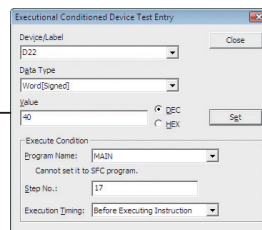

No program modifications required

Configure the device setting by choosing the step No. and execution timing (before/after instruction execution).

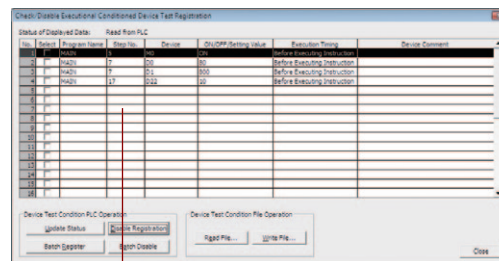

A list of all devices being controlled by the function is automatically generated and can be saved and recalled for further debugging at a later time.

■ Improved flexibility of device point assignment

Extended range of bit devices

Bit devices, internal relay (M) and link relay (B), can now be assigned up to 60K points each. Previous models are limited to 32K points. The total number of device points remains the same, however greater flexibility of device utilization and programming is achieved.

Expand bit and word devices

File register extended setting: data registers and link registers*1

The number of Data Register (D) and Link Register (W) device points of can be extended using standard ROM or a memory card. Previous models only allow the extension of File Register (R/ZR) device points. Using this setting, it is easy to create more data or link registers to accommodate program changes, etc.

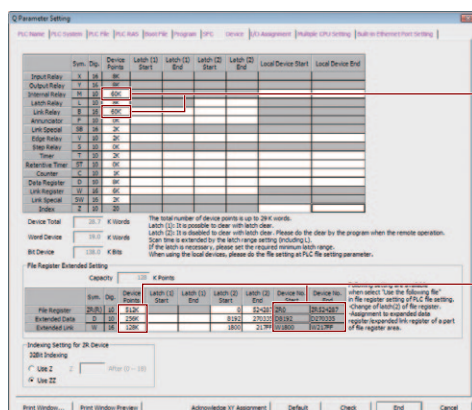

Extended range of bit devices
 Internal relays (M) and link relays (B) can be assigned up to 60K points.

File register extended setting
 For example, the 896K points of word devices in the standard ROM area of a Q100UDEHCPU can be divided as follows.

- File register (R): 512K points
- Extended data register (D): 256K points
- Extended link register (W): 128K points

*1: Not supported by Q00UJ.

Easy Maintenance



■ Fully compatible with standard Q Series

Use existing Q Series modules

Conventional Q Series modules are compatible with the Universal model QCPU Series. Therefore, when requiring an upgrade, system maintenance costs of existing systems can be kept to a minimum with little disruption when changing over.

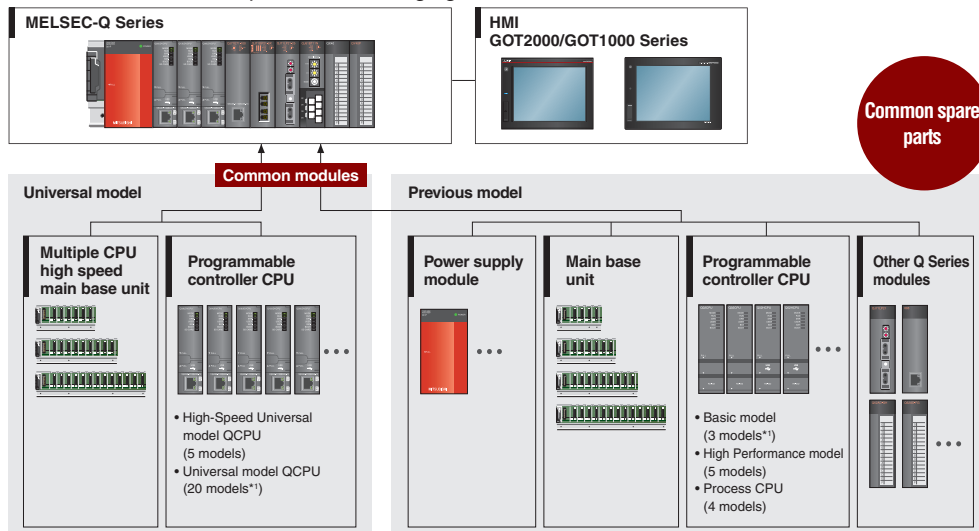

*1: The Q00UJCPU and Q00JCPU are all-in-one type, with integrated power supply, 5-slot base unit, and CPU.

Use existing Q Series programs

Conventional QCPU programs can be used just by changing the PLC type*2 within the programming tool, which enables easy upgrade to the Universal model Series with little re-engineering required.

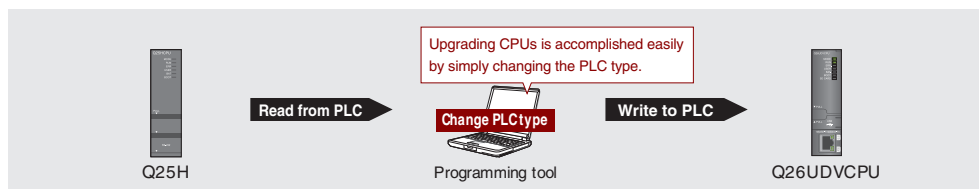

*2: Depending on the program, the number of steps may vary when the PLC type is changed.

■ Automatically backup critical data

Programs and parameter files are automatically backed up to the program memory (Flash ROM) which does not require battery backup. This prevents loss of program and parameter data owing to failure in battery replacement. Also, back-up of important data such as device data can be registered to the standard ROM in order to prevent data loss due to a flat battery in case of planned outage during consecutive holidays. The backup data is restored automatically when the power is restored.

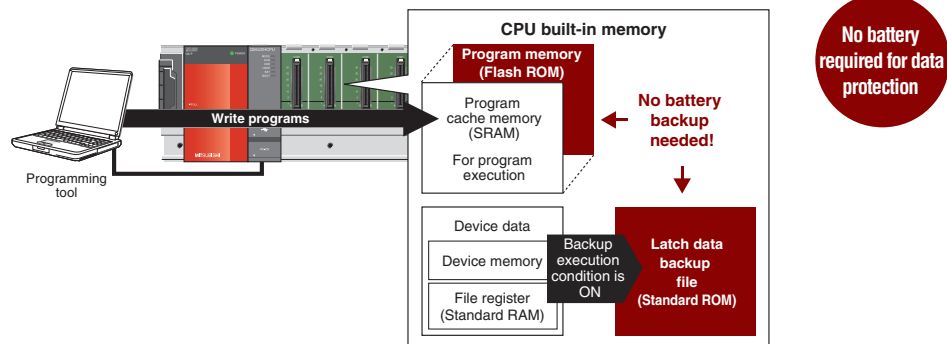

■ Shorten system down recovery time

CPU module change function*1

The CPU module change function allows the user to create a comprehensive backup of all CPU information to a memory card. In the unlikely event of a CPU failure or other catastrophic event, the backup data can be used to quickly program a new CPU module. Using this function, the system can rapidly be made operational and downtime can be minimized.

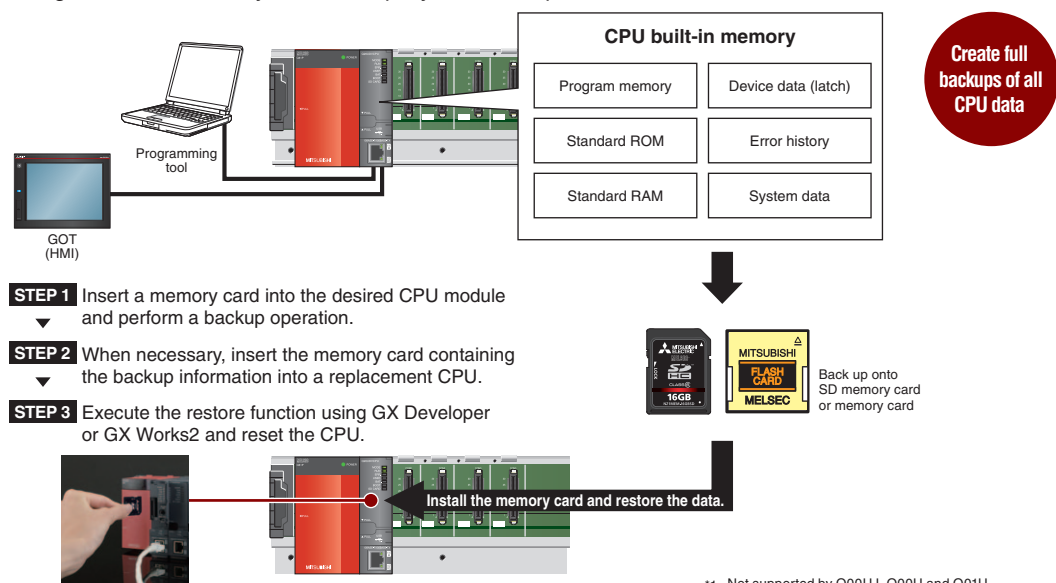

■ Serial numbers are now printed on the front of modules

Serial numbers can be checked quickly without having to remove them from the base unit (No interruption of operation is necessary). Also, serial numbers may be checked using the "product information list" feature included in GX Developer and GX Works2.

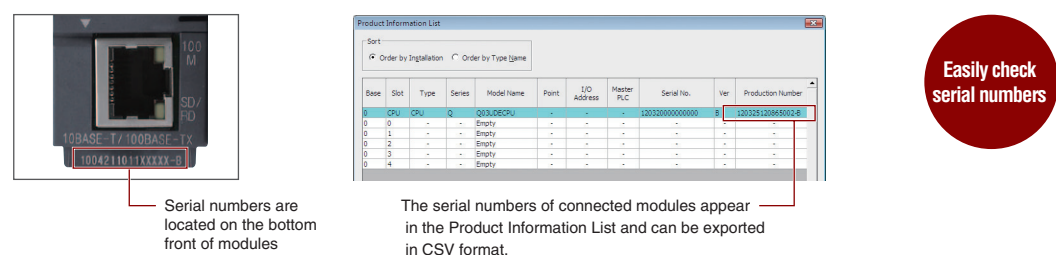



The iQ Platform incorporates many different CPU types to integrate multiple control disciplines

The MELSEC-Q Series offers programmable controller, process, redundant, C language, motion, robot and CNC CPUs to cover various different control requirements. With the multiple CPU configuration, a best-fit control system can be realized. In addition, high availability systems can be easily realized with the high-reliability redundant system range.

CPU Lineup



MELSEC PROCESS

MELSEC process control is a flexible, highly reliable platform with advanced functionality designed to cost-effectively meet the needs of a wide range of industries.



Realize detailed instrument control to match the process state

- Process CPU..... Q02PHCPU, Q06PHCPU, Q12PHCPU, Q25PHCPU

Q Series process controllers offer features that rival those of costly DCS systems at a fraction of the cost. A single CPU can control a large number of PID loops while simultaneously performing standard sequence control. The process CPUs are complemented by a range of channel isolated high resolution analog I/O modules with online change (hot-swap) capability, and the function block programming and engineering software environment, PX Developer. In addition, PX Developer now supports GX Works2 programming software. With this connection between the two software, both sequence control and loop control programs can be used in the process CPU.

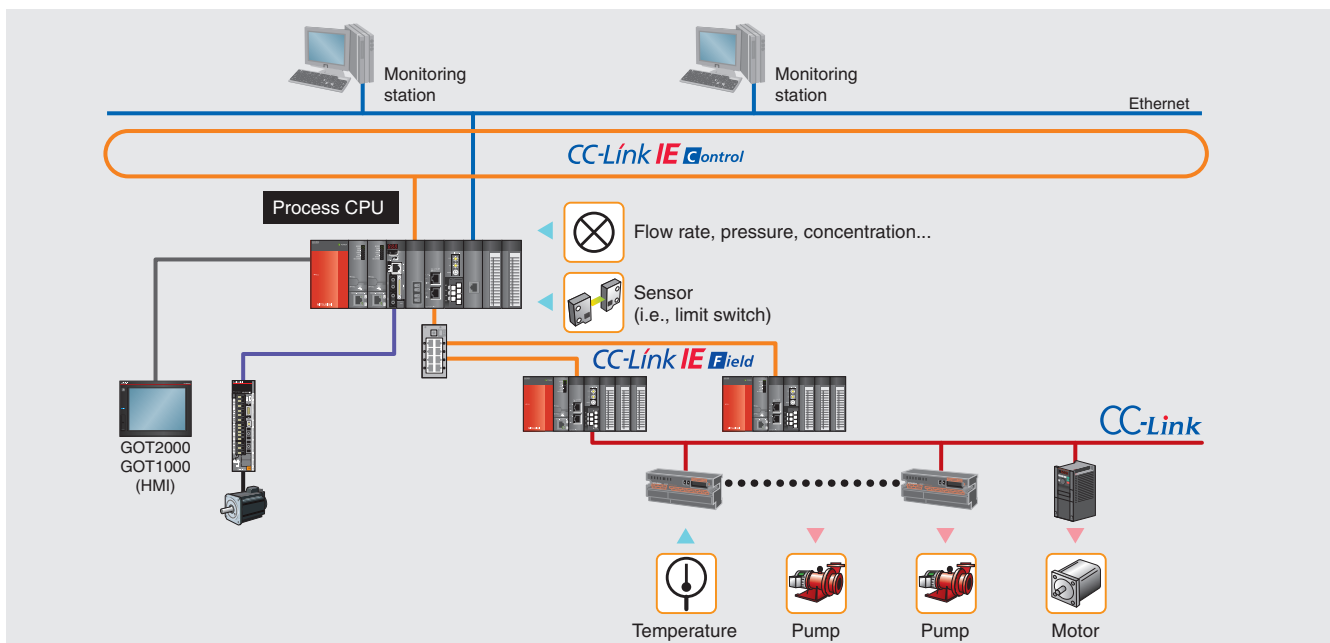

Redundancy to improve your system reliability

● Redundant CPU Q12PRHCPU, Q25PRHCPU

The redundant systems are designed to provide the users with systems that have the properties of Q Series and are not affected by sudden failures. The basic system including CPU module, power supply module, main base unit and network module is redundant to prevent system down. Programming can be performed without consciousness of redundancy.

In addition, PX Developer now supports GX Works2 programming software. With this connection between the two software, both sequence control and loop control programs can be used in the process CPU.



Redundant local I/O system

The CPU directly accesses I/O modules. Ideal for systems requiring high-speed response.

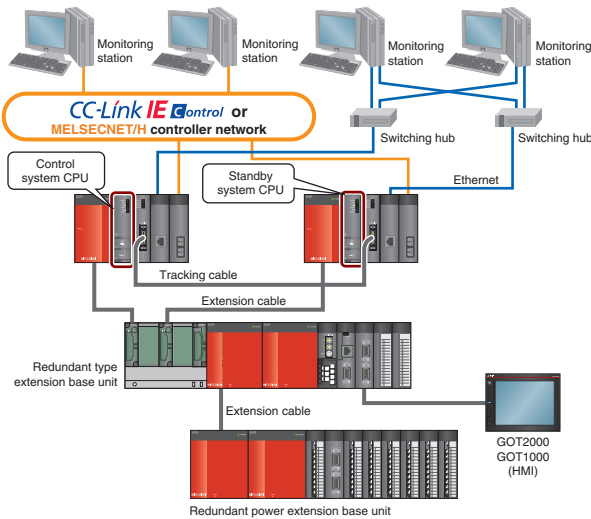

System switching time (Reference)

Approximately 50 ms (Local I/O response time)
 · Standby CPU tracking data acquisition time
 · CPU switching time: Min. 32 ms (without signal flow tracking)

Redundant remote I/O system

Ideal for distributed systems with multiple remote I/O stations.

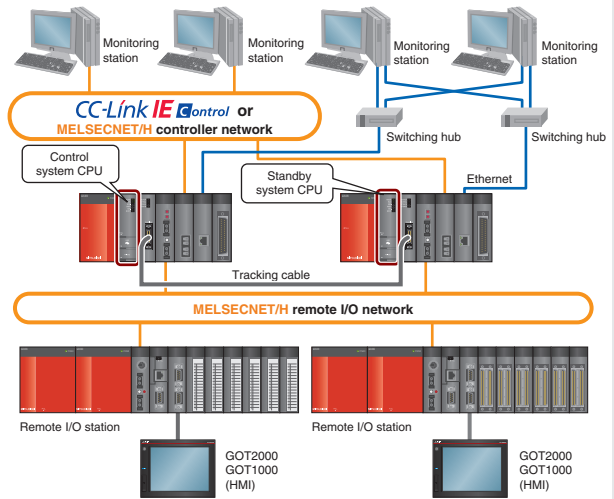

System switching time (Reference)

Approximately 800 ms (Remote I/O response time)
 · Standby CPU tracking data acquisition time
 · Output holding time of remote I/O station during control system switching: 700 to 800 ms
 · CPU switching time: Min. 21 ms (without signal flow tracking)

Discrete process control

Food processing equipment, semiconductor systems, air-conditioning equipment, industrial furnaces, etc.

Continuous process control

Chemical, steel, environmental and water treatment plants, DCS replacement, etc.

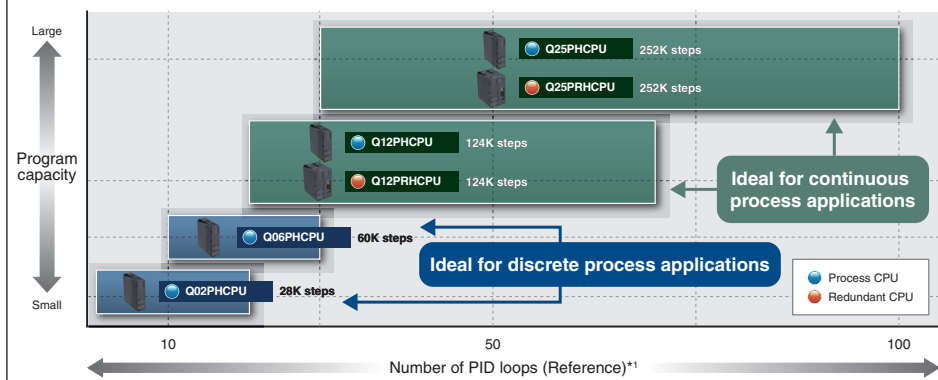

*1: The number of PID loops may change if programs (other than loop control) are large. Refer to the PX Developer Version 1 Programming Manual or Process Technical Guide for details.

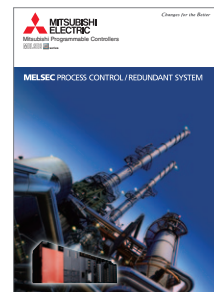

For further details, please refer to the "MELSEC Process Control/Redundant System" catalog (L(NA)08030E).

New possibilities for pre-installed systems connected from the C Controller

**● C Controller CPU
Q24DHCCPU-V, Q24DHCCPU-VG*1, Q24DHCCPU-LS, Q12DCCPU-V**

The C Controller is a generic open platform controller that can execute C language type programs, based on the MELSEC system architecture. It utilizes industrial performance such as long term parts supply, high availability, and advanced functionality. The high-end model Q24DHCCPU-V/-VG comes pre-installed with VxWorks®, and supports advanced information processing and control system I/O. The standard model Q12DCCPU-V is a space saving controller that realizes high-speed I/O control. The Q24DHCCPU-LS is an OS independent controller. Linux® based control can be easily realized by installing 3rd Party partner OS, supporting advanced information processing with a user interface environment close to conventional personal computers. Wide scope of applications are realized with the availability of these 4 C Controllers, used together with MELSEC-Q Series I/O modules, 3rd Party products, open source, and customized applications/programs. Providing freedom with a robust, easier and high-performance system.



For further details, please refer to the "iQ Platform Real Time Operating System C Controller (L(NA)08165E)" catalog.

*1: Set product (Q24DHCCPU-VG-B000/B002) with GENWARE® 3-VG by International Laboratory Corporation.

Ideal for a diverse range of systems, based on a generic platform architecture

Leveraging the C Controller to realizing customized systems, by utilization of 3rd Party applications, installation of 3rd Party partner OS, utilization of programs, and open source applications.

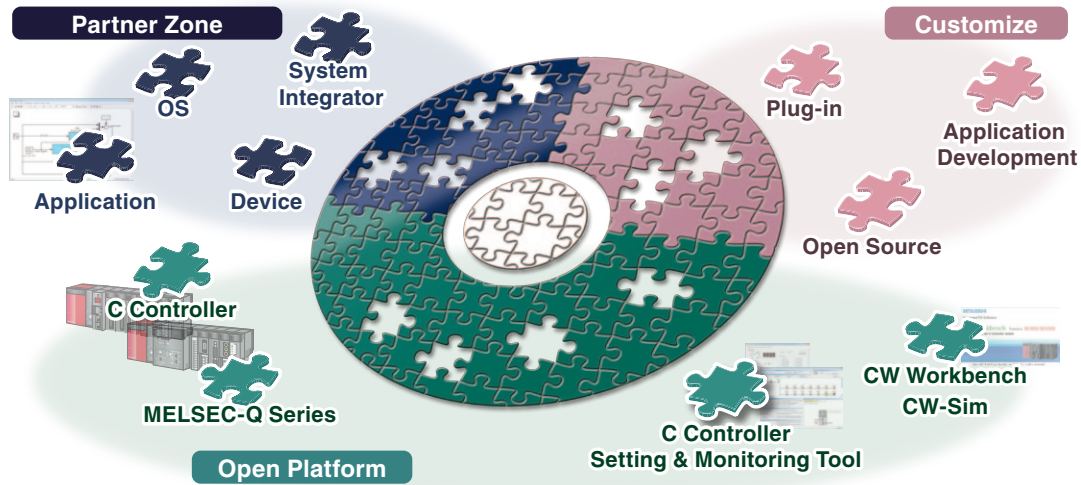

The C Controller overcomes the overheads associated with maintaining embedded PCs (micro boards, etc.) and industrial PCs realizing a cost effective solution.

The C Controller platform is a solution that realizes personal computer level functionality without the burden of high maintenance costs usually associated with personal computers. In addition, it includes a robust design that is ideal for industrial environments by being based on the high quality MELSEC control system.

Common drawbacks associated with embedded and industrial PCs

- Short product life cycle
- Specialized, costly driver development
- Large physical space required
- Frequent maintenance required
- Discontinued production of boards & chips

Old Platform (Microcomputer/PC)

- Disrupted product supply due to discontinued production
- Escalating management and maintenance costs



Merits of using MELSEC-Q Series hardware

- Highly reliable, long-term stable supply
- Total solution provided by a large number of I/Os and seamless network access
- Utilization of C language programs
- Significantly reduced maintenance costs
- Reduced equipment size

New Platform (MELSEC-Q)

- Stable product supply
- Lower maintenance and management costs allows resources to be focused on development



Flexibly connecting with servo amplifiers and servo motors, etc., via SSCNET III/H

● **Motion CPU** **Q173DSCPU, Q172DSCPU**

Each MELSEC-Q Series Motion controller is capable of high-speed control of up to 32 axes (96 axes when using three CPUs together). Each Motion CPU is the same size as a standard Q Series programmable controller. The new generation Motion controller is packed with advanced functions while saving space with its smaller size.

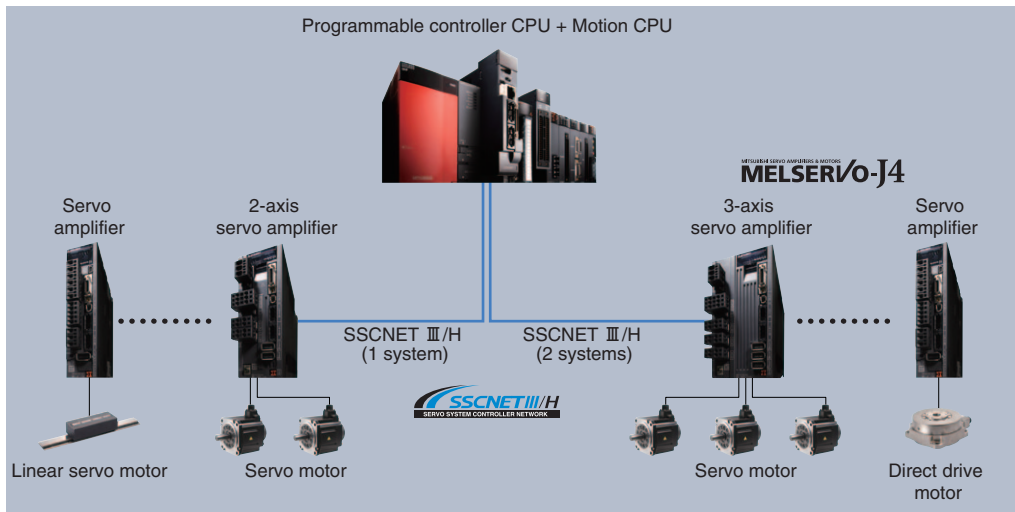

For further details, please refer to the "Servo System Controllers (L(NA)03062)" catalog.

Automating production sites with robots

● **Robot controller** **CR750-Q, CR751-Q**

The iQ Platform compatible robot controller increases the speed of data communications between CPUs and dramatically reduces I/O processing times using a high-speed standard base between multiple CPUs.

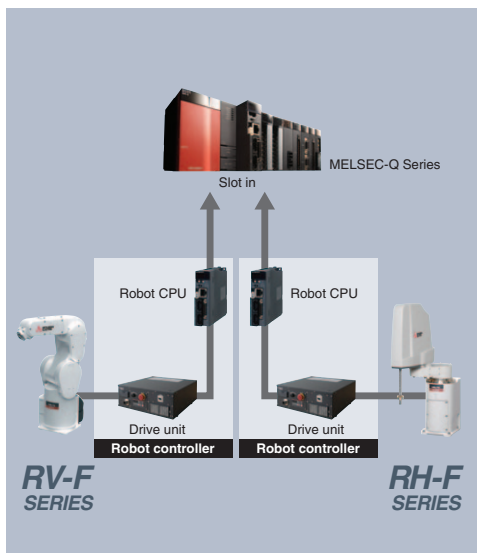

For further details, please refer to the "INDUSTRIAL ROBOT MELFA F Series (L(NA)-09067ENG)" catalog.

Integrating the high-performance CNC with high-speed PLC

● **CNCCPU** **Q173NCCPU**

This CNC controller is part of the Mitsubishi FA integration solution "iQ Platform". The integration of the high-performance CNC and high-speed programmable controller helps reduce the total operation cycle time. Supporting a wide range of interface and I/O modules flexible to many different applications.

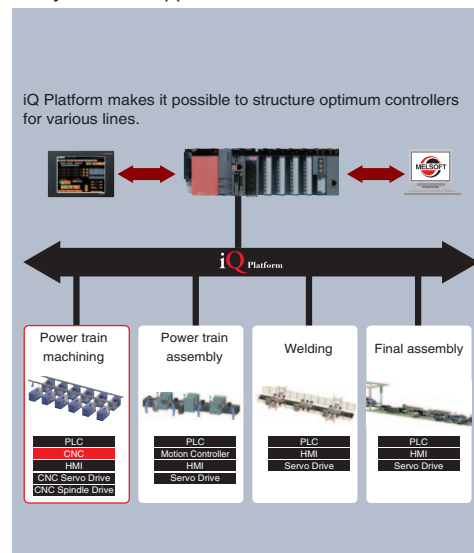

For further details, please refer to the "iQ Platform CNC C70 Series (BNP-A1214(ENG))" catalog.

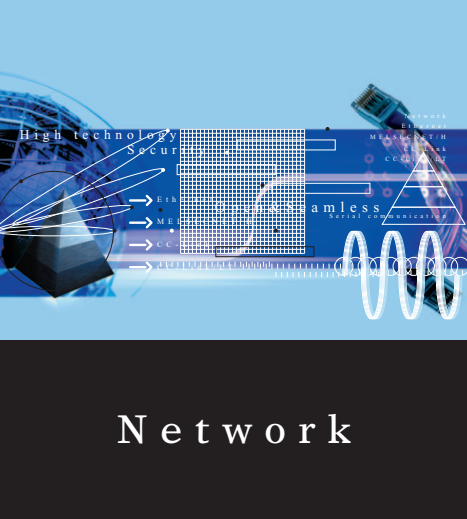

Seamless communication between upper-level information systems and lower-level field systems; scalable to fit any application size

Today there is an increasing demand from production facilities for high speed control, effective management of data, flexible wiring, easy parameter settings, and predictive maintenance.

To answer these demands, Mitsubishi Electric has teamed up with the CC-Link Partner Association to provide reliable, open-standards networks that operate seamlessly with one another. Together, these and other Mitsubishi networks allow for flexible integration at any network level. The latest addition to the CC-Link portfolio is IE Field; an Ethernet based gigabit network designed to provide cost-effective, reliable connectivity to field devices.

Network Configurations

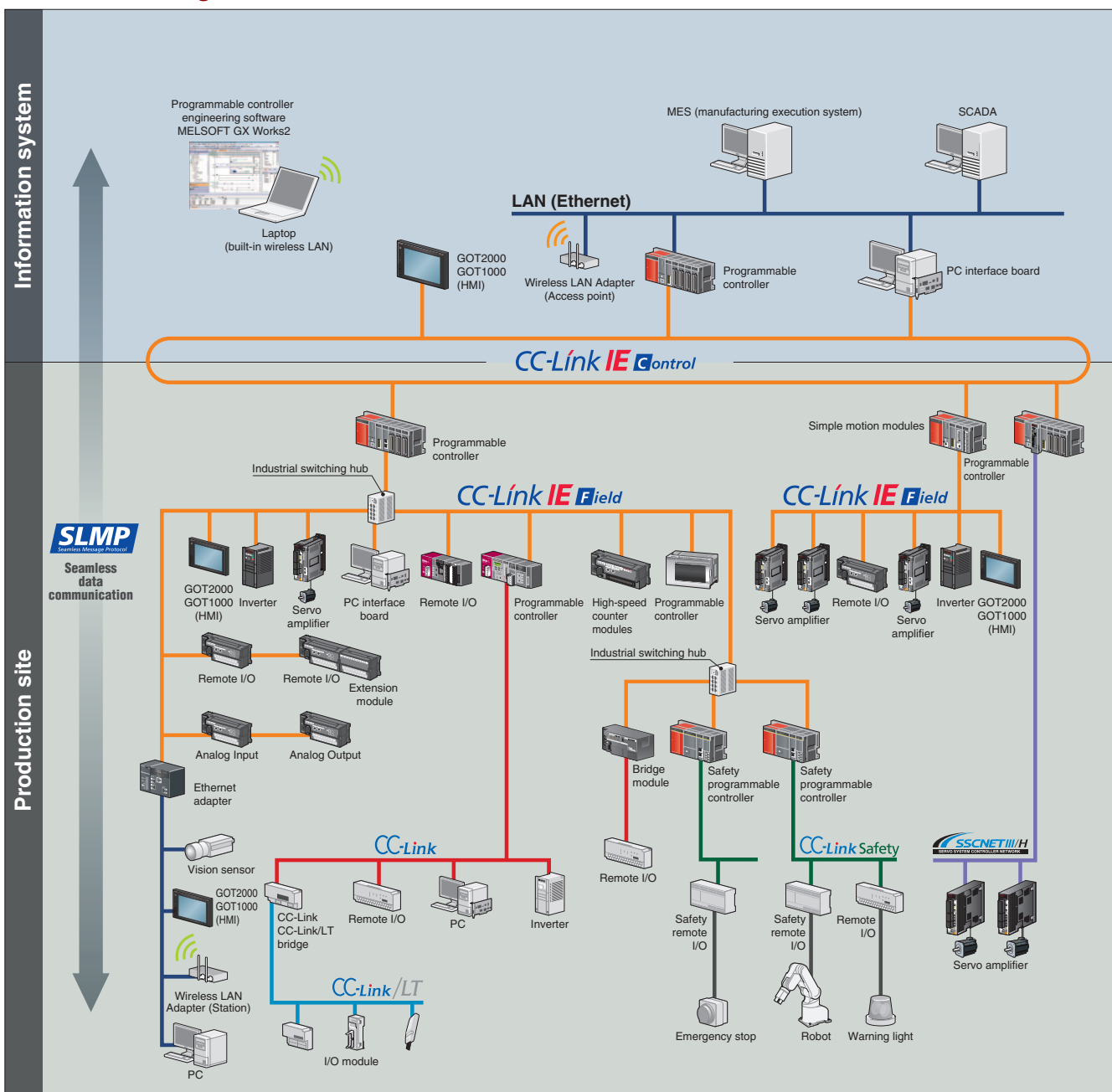

Seamless communication

Seamless data communication through Ethernet, CC-Link IE Control, CC-Link IE Field, and CC-Link networks allow easy access to information, no matter where it resides on the network. Through this technology, it is possible to “drill down” from the Enterprise or IT layer through multiple networks accessing programming controllers using GX Works2 programming or other related software.

In addition, many devices supporting SLMP*1 such as vision sensors and RFID controllers may be connected to the CC-Link IE Field Network.

*1: SLMP (SeamLess Message Protocol) is a protocol advocated by the CC-Link Partner Association.



CC-Link IE Control

CC-Link IE Control is a high-reliability distributed control network designed to handle very large data communications (128K word) over a high-speed (1 Gbps) dual loop optical cable topology.

*: Compatible modules: QJ71GP21-SX, QJ71GP21S-SX

CC-Link IE Field

CC-Link IE Field is an all-round versatile gigabit Ethernet based network integrating controller, I/O control, safety control, and motion control in a flexible wiring topology supporting star, ring, and line configurations.

*: Compatible modules: QJ71GF11-T2, QS0J71GF11-T2 (safety control), QD77GF16 (motion control)

CC-Link

CC-Link is a high-speed and high-reliable deterministic I/O control network which realizes reduced wiring whilst offering multi-vendor compatible products. This open field network is a global standard originating from Japan and Asia.

*: Compatible modules: QJ61BT11N

CC-Link Safety

CC-Link Safety is a safety field network that prevents risks on the shop floor. This realizes a highly-reliable and a high-speed communication with less wiring.

*: Compatible modules: QS0J61BT12

SSCNET III/H

SSCNET III/H is a dedicated high-speed, high-performance, and highly reliable servo system control network which offers flexible long distance wiring capabilities based on optical fiber cable topology.

*: Compatible modules: QD77MS2, QD77MS4, QD77MS16

CC-Link/LT

CC-Link/LT is a wire-saving sensor level network which is designed for use in panels between simple discrete devices. Its wiring system is based on reducing incorrect wiring and is based on CC-Link realizing high-speed and robust noise resistance features.

*: Compatible module: QJ61CL12

BACnet™

This network supports the communication protocol standard BACnet™ client function. This network is mainly used to monitor and control air-conditioning, lighting and fire detection, etc. in building automation system applications.

*: Compatible modules: QnUDVCP, QJ71E71-100 (client only)

MODBUS®

Q-Series is now supporting the MODBUS® protocol network, realizing easy communication, with various MODBUS® slave devices compatible with Ethernet MODBUS®/TCP or RS-232/422/485 serial communication.

*: Module supporting MODBUS®/TCP : QJ71MT91 (master/slave functions), QnUDVCP, QJ71E71-100 (master only)
 *: Modules supporting MODBUS®: QJ71MB91 (master/slave functions), QJ71C24N (-R2/R4) (master only)

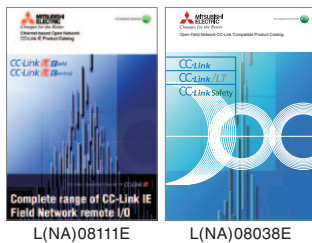

L(NA)08111E L(NA)08038E

For further details about CC-Link networks, please refer to the "CC-Link IE" or "CC-Link Compatible Products" catalogs.

Network	Application	Enterprise level network		Device level network			Sensor level network
		Information communication	Control level network Controller distributed control	I/O control	Safety control	Motion control	Control
Ethernet		●					
CC-Link IE Control			●				
CC-Link IE Field			●	●	●	●	
CC-Link				●			
CC-Link Safety					●		
CC-Link/LT							●
SSCNET III/H						●	
BACnet™		●					
MODBUS®/TCP			●				
MODBUS®				●			

Highly reliable distributed control network designed for large bandwidth and high-speed

● CC-Link IE Control Network module

Standard model..... **QJ71GP21-SX**

With external power supply function..... **QJ71GP21S-SX**

- » Commercially available Ethernet components can be used for significant cost savings over alternative networks.
- » Deterministic, reliable performance helps to reduce operation cycle time. This cyclic data exchange is fixed and will not suffer from degraded performance even when large volumes of data are transferred.
- » Share massive amounts of data between controllers. (Up to 256K bytes of network shared memory per station)
- » The CC-Link IE Control Network modules, QJ71GP21-SX and QJ71GP21S-SX, may be configured as normal stations, or the control station.

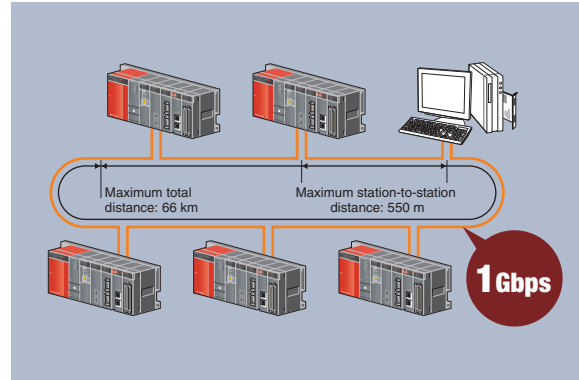

CC-Link IE Control

■ Performance Specifications^{*1}

Item		Specification	
Max. link points per network	LB	32K points (32768 points, 4 KB) (Basic model QCPU or safety CPU: 16K points (16384 points, 2 KB))	
	LW	128K points (131072 points, 256 KB) (Basic model QCPU or safety CPU: 16K points (16384 points, 32 KB))	
	LX	8K points (8192 points, 1 KB)	
	LY	8K points (8192 points, 1 KB)	
Max. link points per station		Regular mode	Extended mode ^{*2}
	LB	16K points (16384 points, 2 KB)	32K points (32768 points, 4 KB)
	LW	16K points (16384 points, 32 KB)	128K points (131072 points, 256 KB)
	LX	8K points (8192 points, 1 KB)	8K points (8192 points, 1 KB)
	LY	8K points (8192 points, 1 KB)	8K points (8192 points, 1 KB)
Communication speed		1 Gbps	
Number of stations per network		120 (1 control station plus 119 normal stations)	
Connection cable		Optical fiber cable (Multi-mode fiber)	
Overall cable distance		66000 m (When 120 stations are connected)	
Station-to-station distance (Max.)		550 m (Core/Clad = 50/125 (m))	
Max. number of networks		239	
Max. number of groups		32	
Network topology		Ring	

*1: When the control station is a Universal model QCPU.

*2: To use extended mode, (QJ71GP21(S)-SX) network modules and Universal model CPUs whose first five serial number digits are 12052 or later are required. All stations in the network must support the extended mode. Also, GX Works2 version 1.34 L or later is required.

Designed to continue functioning even in the worst possible scenarios

- The use of fiber optic cables which are completely immune to EMI and RFI noise allows the network to function in environments where other networks cannot. The dual loop design allows the network to continue functioning even if cables become damaged or the power is lost to a station.
- Additionally, CC-Link IE stations can be powered using an external supply. That allows communication to continue normally in the event of a loss of the primary power supply, without relying on the loop-back function.

Loopback function

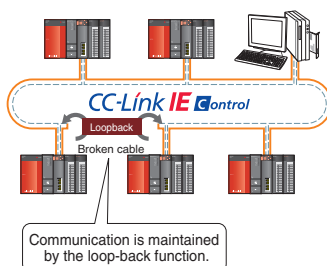

External power supply function

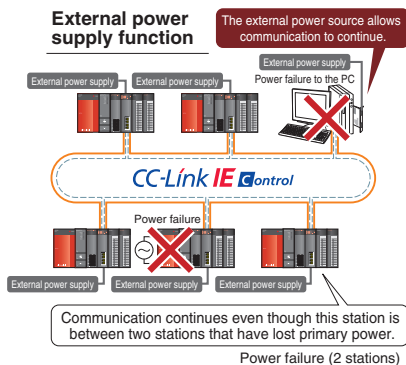

Visual display of network connection status

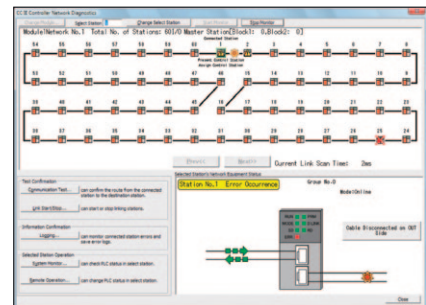

View the network connection status of entire system to identify problems at a glance. The cause of problems can be quickly identified and suggested remedies implemented to minimize down time.



Connect to remote I/O stations and other programmable controllers for high-speed distributed control with advanced functionality

● **CC-Link IE Field Network module..... QJ71GF11-T2**

- » Tremendous speed and bandwidth using commercially available cables and connectors. The network design (topology) is highly flexible to fit any layout.
- » Operates as either a master or local station. Perfect for managing remote I/O control and distributed control.
- » Devices from other stations can be accessed easily via transient communication using dedicated instructions.
- » Function blocks for transient communication are available to further simplify messaging.
- » The network can ensure 32-bit data integrity using the station-based block data assurance function. This forces pairs of word data to get updated together during link refresh.
- » The QJ71GF11-T2 CC-Link IE Field Network module can function as a slave or master station.



■ **Performance Specifications**

Item		Specification
Max. link points per network	RX	16K points (16384 points, 2 KB)
	RY	16K points (16384 points, 2 KB)
	RWr	8K points (8192 points, 16 KB)
	RWw	8K points (8192 points, 16 KB)
Max. link points per station	RX	2K points (2048 points, 256 B)
	RY	2K points (2048 points, 256 B)
	RWr	1K points (1024 points, 2 KB)
	RWw	1K points (1024 points, 2 KB)
Communication speed		1 Gbps
Number of stations per network		121 (1 master plus 120 slave stations)
Connection cable		Ethernet cable of category 5e or higher (Double shielded cable) which satisfies 1000BASE-T standard
Maximum overall cable distance	Line topology	12 km (with 1 master and 120 slaves connected)
	Star topology	Depends on the system configuration.*1
	Ring topology	12.1 km (with 1 master and 120 slaves connected)
Max. station-to-station distance		100 m
Max. number of networks		239
Network topology		Line, star, line and star mixed, or ring*2

*1: Up to 20 hubs can be connected per network.
 *2: Ring networks may not be mixed with line or star networks. QJ71GF11-T2 network modules whose first five serial number digits are 12072 or later are required for ring networks. Additionally, GX Works2 version 1.34 L or later is required.

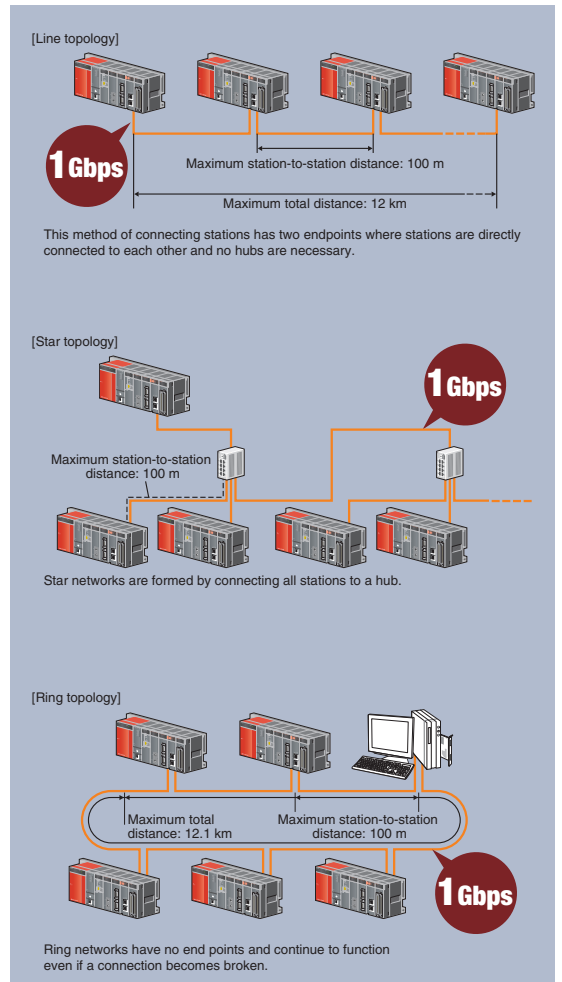

Easy diagnosis functions

- In certain situations such as power loss, a station could be prevented from communicating. In a line network this can cause perfectly healthy stations can become separated from the network. In a ring network, only the faulty station is separated, thus increasing the system reliability.

Line topology

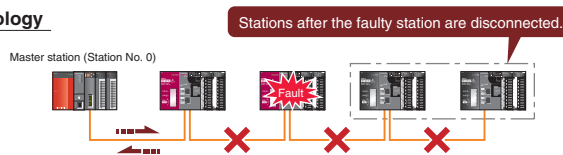

Ring topology

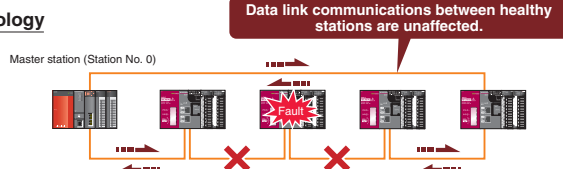

Visual display of network connection status

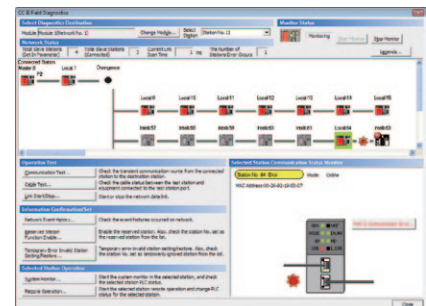

The network diagnostic tools in GX Works2³ allow problems to be identified rapidly. In addition to a visual overview of the network and several other tools, detailed monitoring of CPUs and modules from any station, to any station is possible.

*3: Not supported by GX Developer.

Superior cost-performance field network with many compatible devices

● CC-Link network moduleQJ61BT11N

- » By building on reliable field bus technology, CC-Link is capable of moving large volumes of bit data, like ON/OFF relay status, and word data at high-speed.
- » CC-Link keeps cyclic transmission consistent and guarantees punctuality by separating it from message (transient) communication. Even if message communication becomes saturated, it will not affect the link scan time.
- » The QJ61BT11N module supports CC-Link version 1 and 2, and may be used as a local or master module.

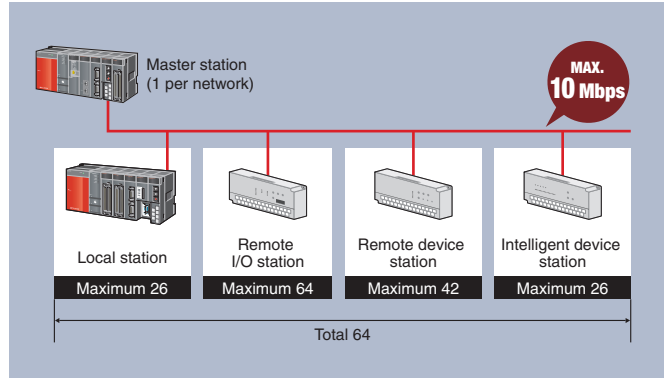

■ Performance Specifications

Item		Specification	
Communication speed		Can select from 156 kbps/625 kbps/2.5 Mbps/5 Mbps/10 Mbps	
Transmission path		Bus (RS-485)	
Maximum number of link points per system ^{*1}		Remote inputs/outputs (RX, RY): 8192 points Remote registers (RWw): 2048 points Remote registers (RWr): 2048 points	
Maximum number of link points per system	Expanded cyclic setting	Single	Remote inputs/outputs (RX, RY): 32 points (30 points for local station) Remote registers (RWw): 4 points Remote registers (RWr): 4 points
		Double	Remote inputs/outputs (RX, RY): 32 points (30 points for local station) Remote registers (RWw): 8 points Remote registers (RWr): 8 points
		Quadruple	Remote inputs/outputs (RX, RY): 64 points (62 points for local station) Remote registers (RWw): 16 points Remote registers (RWr): 16 points
		Octuple	Remote inputs/outputs (RX, RY): 128 points (126 points for local station) Remote registers (RWw): 32 points Remote registers (RWr): 32 points
Maximum number of connected stations (master station)		64 ^{*2}	
Total distance/speed (When using Ver. 1.10)		1200 m/156 kbps, 900 m/625 kbps, 400 m/2.5 Mbps, 160 m/5 Mbps, 100 m/10 Mbps (Using repeaters, it is possible to extend the network distance up to 13.2 km)	

*1: For CC-Link version 2.

*2: Using only remote I/O stations.

Device level wire-saving network

● CC-Link/LT network module.....QJ61CL12

- » The maximum of 64 stations can be updated in as little as 1.2 ms (at 2.5 Mbps). Choose from 3 transmission speeds according to the required transmission distance.
- » CC-Link/LT slave stations do not require any parameters, only the transmission speed needs to be specified by the master station.
- » The QJ61CL12 CC-Link/LT network module can only function as a master station.



■ Performance Specifications

Item		Specification
Communication speed		156 kbps/625 kbps/2.5 Mbps
Transmission path		T-branch topology
Max. connected modules		64
Overall distance	Length of trunk line	35 m/2.5 Mbps, 100 m/625 kbps, 500 m/156 kbps
	Max. length drop line	4 m/2.5 Mbps, 16 m/625 kbps, 60 m/156 kbps
	Overall length drop lines	15 m/2.5 Mbps, 50 m/625 kbps, 200 m/156 kbps



Cost-effective distributed control network compatible with A and AnS Series

● MELSECNET/H network module

Optical loop type... **QJ71LP21-25, QJ71LP21S-25, QJ71LP21G, QJ72LP25-25, QJ72LP25G** (Remote I/O station)

Coaxial bus type **QJ71BR11, QJ72BR15** (Remote I/O station)

Twisted bus type **QJ71NT11B**

- » MELSECNET/H network systems support controller-to-controller, controller-to-personal computer, and controller-to-remote I/O station communications. Multiple wiring types are available and many functions designed to increase reliability are included, such as support for redundant systems.
- » Optical loop type: Communication speeds up to 25 Mbps. Fiber optic cable is immune to EMI/RFI noise. Up to 2 km between stations using GI type cable.
- » Coaxial bus type: Using low cost coaxial cable allows networks to be constructed at less cost than optical loop networks.
- » Twisted bus type: The combination of an affordable network module and twisted-pair cables allows a network system to be built at very low cost.

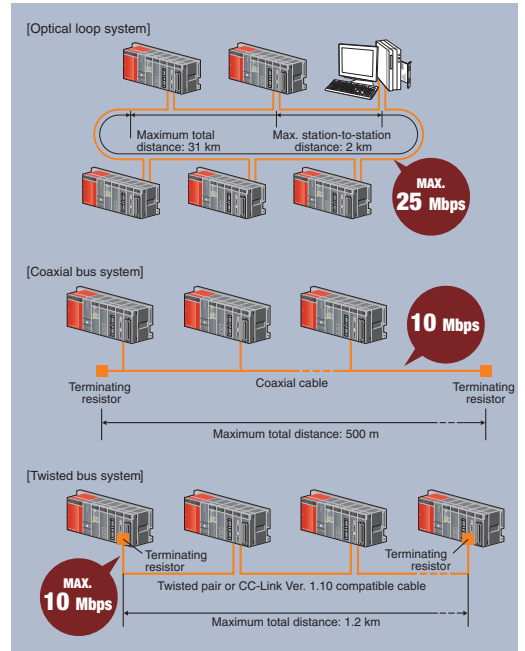

■ Performance Specifications

Item		Specification						
Network configurations		Optical loop system		Coaxial bus system		Twisted bus system		
Model		QJ71LP21(S)-25 QJ72LP25-25	QJ71LP21G QJ72LP25G	QJ71BR11 QJ72BR15	QJ71NT11B			
Cable		Fiber optic (SI)	Fiber optic (GI)	Coaxial (3C-2V)	Coaxial (5C-2V)	Twisted pair	CC-Link Ver. 1.10-compatible cable	
PLC to PLC network	Maximum number of link points per network	LB	16384 points (8192 points in the MELSECNET/10 mode)				16384 points	
		LW	16384 points (8192 points in the MELSECNET/10 mode)				16384 points	
		LX/LY	8192 points					
	Maximum number of link points per station	•MELSECNET/H mode $\{(LY + LB) / 8 + (2 \times LW)\} \leq 2000$ bytes •MELSECNET/H extended mode $\{(LY + LB) / 8 + (2 \times LW)\} \leq 35840$ bytes						
Number of stations per network		Up to 64 stations (1 control station, 63 normal stations)		Up to 32 stations (1 control station, 31 normal stations)				
Remote I/O network	Maximum number of link points per network	LB	16384 points (Remote Master to Remote Sub-master or Remote I/O: 8192 points, Remote Sub-master or Remote I/O to Remote Master: 8192 points)					
		LW	16384 points (Remote Master to Remote Sub-master or Remote I/O: 8192 points, Remote Sub-master or Remote I/O to Remote Master: 8192 points)					
		LX/LY	8192 points					
	Maximum number of link points per station	• Remote Master to Remote I/O $\{(LY + LB) / 8 + (2 \times LW)\} \leq 1600$ bytes • Remote I/O to Remote Master $\{(LX + LB) / 8 + (2 \times LW)\} \leq 1600$ bytes • Multiplexed Remote Master from/to Multiplexed Remote Sub-master $\{(LY + LB) / 8 + (2 \times LW)\} \leq 2000$ bytes						
	Maximum I/O points per remote I/O station	$X + Y \leq 4096$ points If X/Y numbers are duplicated, only one side is taken into consideration.						
	Device points per remote I/O station	M	8192 points					
		SM	2048 points					
		D	12288 points					
SD		2048 points						
Number of stations per network		Up to 65 stations (1 remote master station, 64 remote I/O stations)		Up to 33 stations (1 remote master station, 32 remote I/O stations)				
Communication speed		25 Mbps/10 Mbps		10 Mbps		156 kbps/312 kbps/625 kbps/1.25 Mbps/2.5 Mbps/5 Mbps/10 Mbps		
Overall distance		30 km		300 m	500 m	1200 m/156 kbps, 900 m/312 kbps, 600 m/625 kbps, 400 m/1.25 Mbps, 200 m/2.5 Mbps, 150 m/5 Mbps, 100 m/10 Mbps		
Distance between stations		Up to 1 km		2 km	—		—	

Interface module connectable with multiple Ethernet devices

● Ethernet interface module

10BASE-T/100BASE-TX	QJ71E71-100
10BASE-5	QJ71E71-B5
10BASE-2	QJ71E71-B2

- » Use dedicated instructions for communication between programmable controller CPUs.
- » A communication library and sample code is available to allow a web server to access any of the Ethernet modules and exchange information with the programmable controller CPU module. In this way, the web server may host a web page that allows remote operation of a programmable controller over the Internet via web browser.
- » To improve programming, maintenance, and debugging efficiency, multiple CPU connections may be established simultaneously using GX Developer and GX Works2.
- » The E-mail Function allows Ethernet modules to send e-mail with attachments in binary, ASCII, and CSV formats via a mail server.
- » Perform existence checks and keep connections open using the KeepAlive or PING functions. This can be used to ensure connectivity and quickly discover errors.

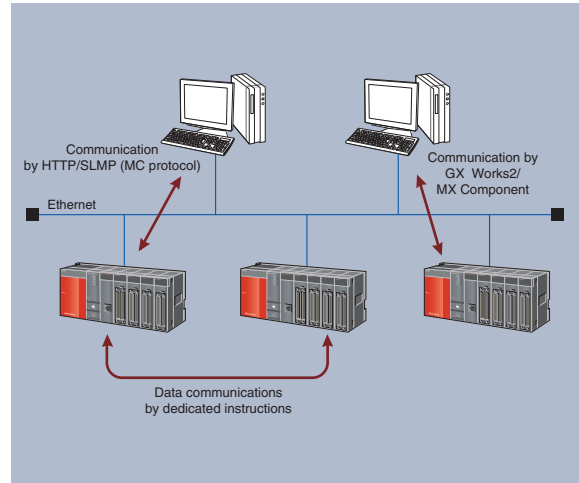

Connect with a large variety of devices using the MODBUS® interface module

● MODBUS® interface module

RS-232 1ch, RS-422/485 1ch	QJ71MB91
10BASE-T/100BASE-TX	QJ71MT91

- » Using the master function, communicate with 3rd party MODBUS® compatible slave devices.
- » Slave mode is also supported, which allows communication with other MODBUS® masters such as 3rd party programmable controllers.
- » Using the QJ71MB91 synchronization function, a master station may be connected to CH1 (RS-232) and communicate with multiple slaves connected to the CH2 (RS-422/485) interface.
- » The QJ71MT91 module is able to operate using the master and slave functions simultaneously.

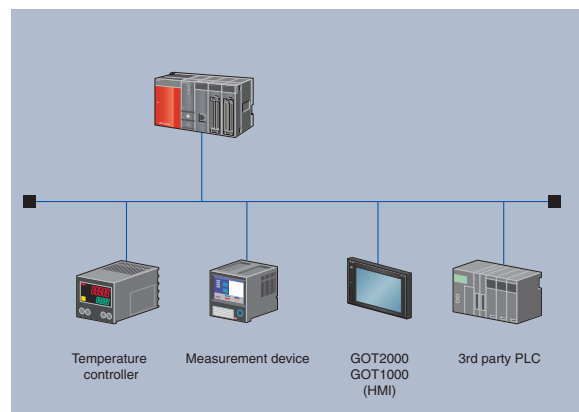

These highly flexible communications modules allow connection to practically any serial device

● Serial communication module

RS-232 1ch, RS-422/485 1ch	QJ71C24N
RS-232 2ch	QJ71C24N-R2
RS422/485 2ch	QJ71C24N-R4

- » Push the limits of serial technology: baud rates up to 230.4 kbps, distance up to 1200 m, and multiple block batch read/write up to 960 words from QCPU device memory.
- » External devices (personal computer, HMI, etc.) may read and write data in the programmable controller CPU using MC protocol.
- » Connect with intelligent devices using their native protocol (barcode reader, measurement device, etc.) by selecting non-procedure protocol and using a sequence program for communication control.
- » MELSOFT engineering tools can establish a connection to the programmable controller CPU through the serial connection to perform programming and maintenance duties.
- » Dedicated functions are available to facilitate RS-232 communication over public telephone lines using a serial modem. One of them, the remote password function, prevents unauthorized access to programmable controllers via the modem line.

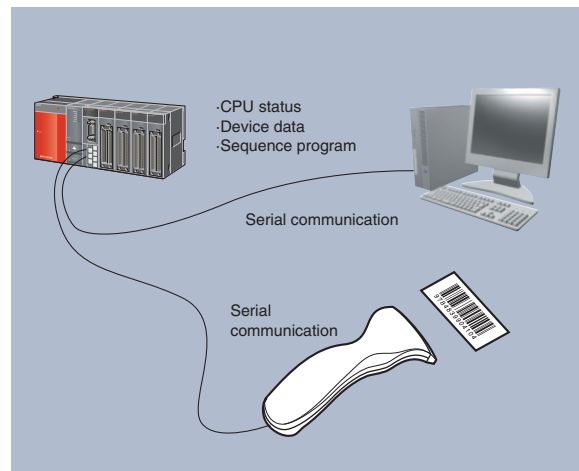



Easier to use through combination of Ethernet/serial communication module and GX Works2 (predefined protocol support function)

Communication with any device can be started quickly only by selecting the device from the predefined protocol library.

- ① Select the manufacturer and model (series) of the device to be connected.
There is no need for complicated predefined protocol setting for the device.
Simply select from communications protocol libraries such as MODBUS® and BACnet™, which are prepared in advance.

- ② Write the predefined protocol to the module.
Write the set predefined protocol to QJ71E71-100, QJ71C24N (-R2/R4) module. Up to 128 protocols can be set in one module.

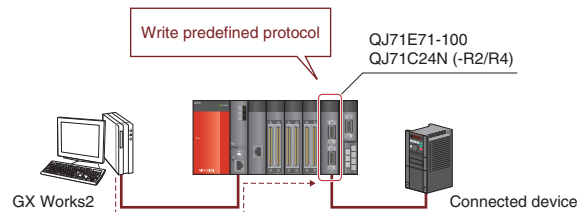
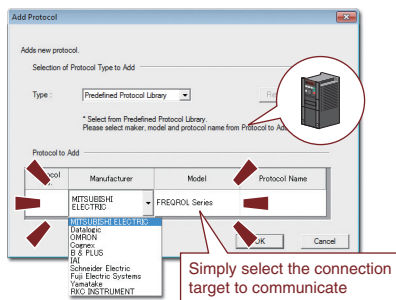

- ③ Execute the protocol with ladder program.
With ladder program, communication with any external device can be made only by executing a dedicated predefined protocol starting instruction.

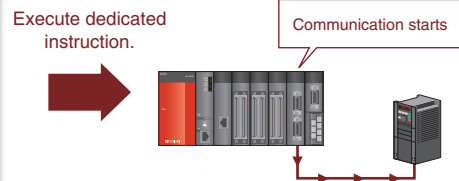
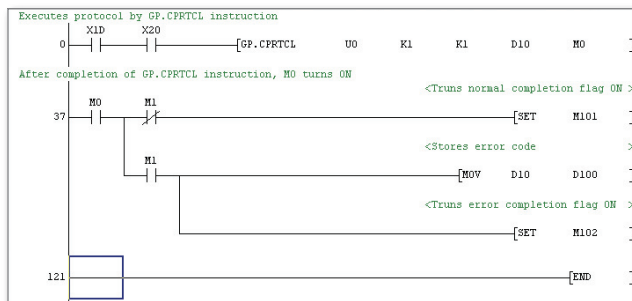

Easy to prepare and edit predefined protocol

- Even if the device to be connected is not contained in the predefined protocol library, the device can be added easily.
- The contents of the prepared predefined protocol can be displayed in list form. The protocol can be edited easily.

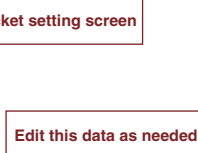
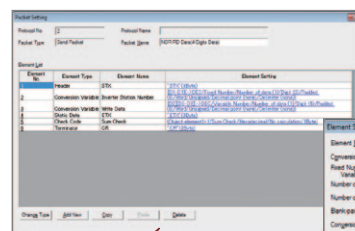
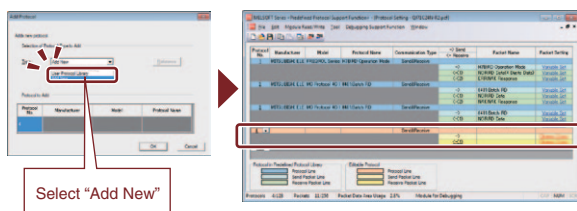
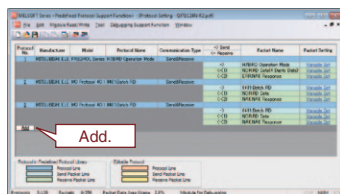

* Supported by QJ71C24N (-R2/R4) with the function version B and a serial number whose first 5 digits are 11062 or higher.
* Supported by products with the first five digits of the QJ71E71-100 product number of 15042 or later.

Make the jump from shop floor data to valuable information in real time

● MES interface module **QJ71MES96**

- » Simplify the process of connecting to enterprise system databases such as an MES*1 by connecting directly. Configuration of the module is easy, and does not require any programming.
- » When user-defined trigger conditions occur, the specified data is read and transferred via SQL text. This event-driven communication method reduces network loading when compared to conventional solutions, which are based on polling architecture.

- » Executes pre-registered SQL jobs. Also receives production instructions from MES and downloads production information from the database.

*1: MES (Manufacturing Execution System): A system that manages and controls production activities to optimize quality, production volume, delivery, costs, etc.

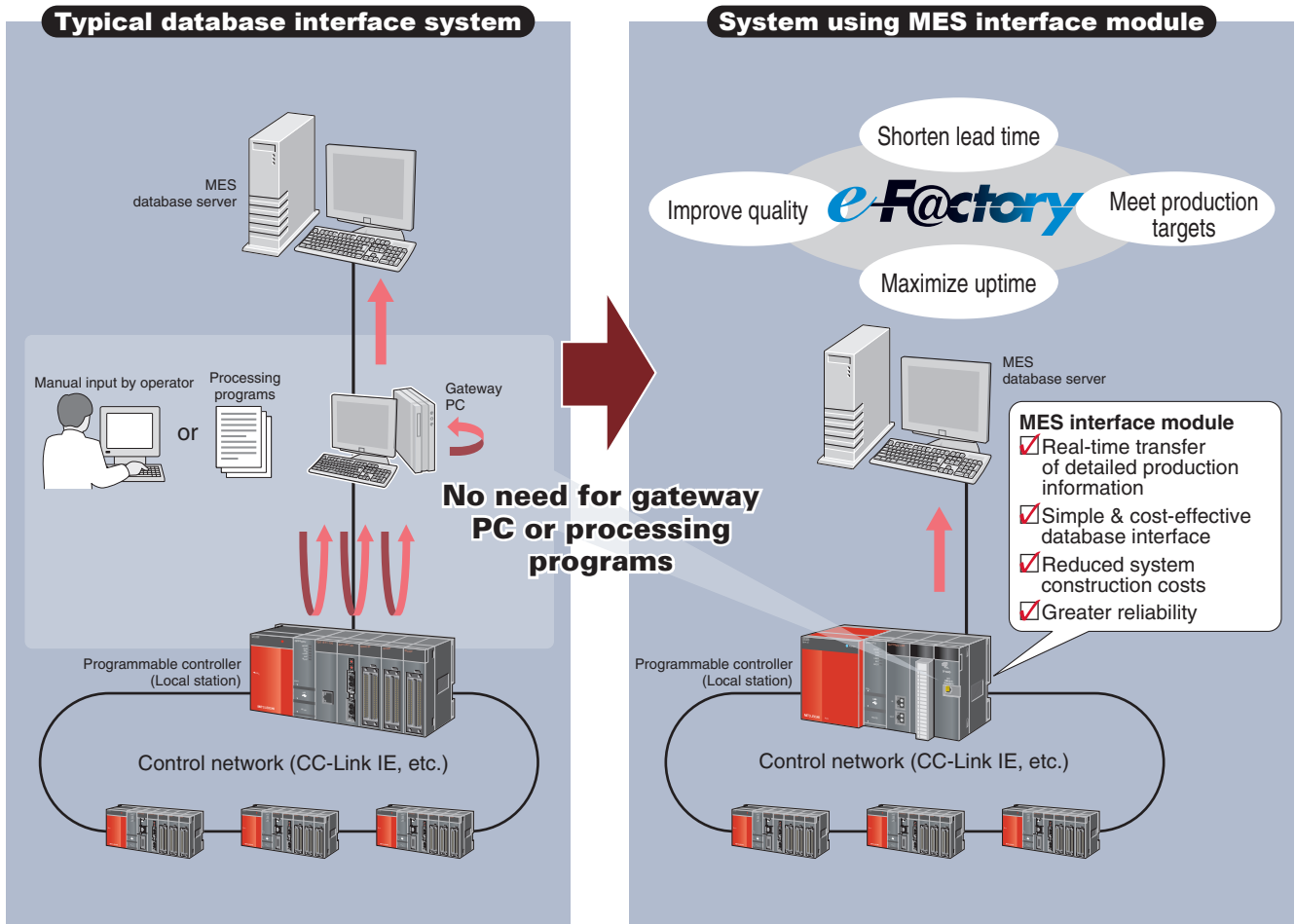

The e-F@ctory concept aims to achieve the maximum benefit from manufacturing equipment by providing detailed information, from the shop floor directly to a MES (Manufacturing Execution System). This enables real-time decision making and production site optimization.



Fulfill the need for traceability and discover a powerful troubleshooting tool

High speed data logger module QD81DL96

» High speed data sampling function

The high speed data sampling function has the power to synchronize with the sequence program scan, ensuring that every value available to the program is logged for analysis. Using this method it is possible to perform detailed operational analysis and identify existing or potential problems.

» Trigger logging function

Trigger logging allows the user to specify, in great detail, when data should be saved. This greatly simplifies the process of investigating why a problem has occurred and assists in the quick identification of solutions. Additionally, it allows CompactFlash memory card space to be used efficiently.

» The logging data display and analysis tool, GX LogViewer, has a simple and effective interface that is user customizable and includes features to maximize the efficiency of analyzing collected data. The High speed Data Logger Module Configuration Tool enables the user to create sophisticated data collection rules using an intuitive step-by-step process. The wizard like interface is beginner-friendly and includes features like importing global labels and device comments.

» Automatic generation of reports including graphs

By creating an Excel® layout file and transferring it to the module, the report function can automatically fill in the numbers using sampled data to create reports on a reoccurring basis. All kinds of reports may be created that include charts, graphs, and other visual aids. It is even possible to e-mail the reports automatically!

High speed data sampling function

Generic sample data from PC or external device at 100 ms intervals

Traditional data logging methods are unable to detect the abnormal values.

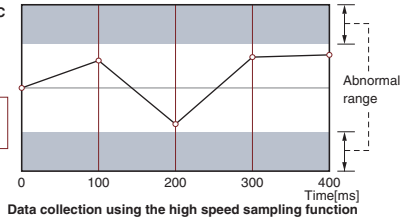

Data collection using the high speed sampling function

The high speed data logger module is capable of sampling data at much higher intervals as to detect fast changing values. (fastest down to 1 ms)

At 20 ms intervals, the high speed data logger clearly identifies the abnormal values.

Synchronize the sample rate to the scan time to reveal all values entering the sequence program.

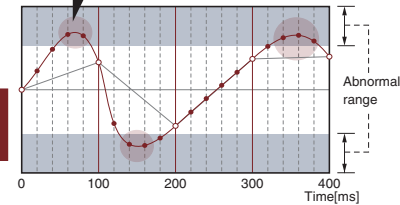

CPUs that support the high speed data sampling function

- High-speed Universal model QCPU Q03UDV, Q04UDV, Q06UDV, Q13UDV, Q26UDV, Q03UD(E), Q04UD(E)H, Q06UD(E)H, Q10UD(E)H, Q13UD(E)H, Q20UD(E)H, Q26UD(E)H, Q50UDEH, Q100UDEH (Compatible with QnU CPU modules starting with serial No. * 11012* or higher.)
- Universal model QCPU

* The high speed data sampling function supports only the host control CPU. (Other stations on the network are not supported.)

High speed data logger module tools

Data display and analysis tool: GX LogViewer

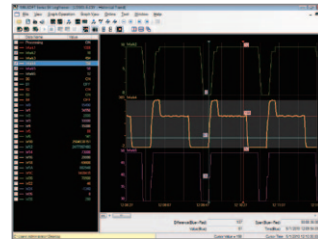

View a list of events or a trend graph [pictured left] either in real-time (online) or historical (saved file) modes. Helpful features ensure key information is immediately visible.

High speed data logger module configuration tool

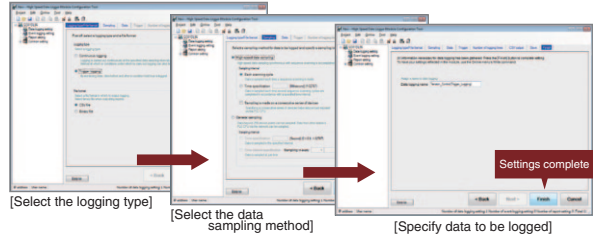

Even making sophisticated data collection rules is easy to do using the intuitive step-by-step configuration process.

* The High speed Data Logger Module Tools are available at no additional cost. Please contact your nearest Mitsubishi Electric representative for details.

Trigger logging function

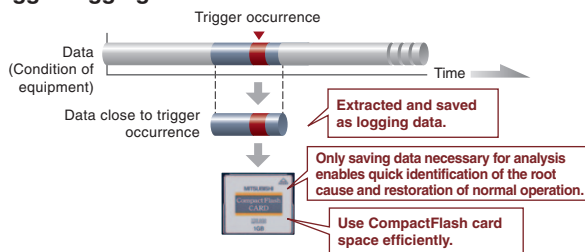

By only saving data immediately before and after a trigger occurrence, the search for problems and their causes is made highly efficient.

It is possible to identify and resolve problems very quickly.

Before trigger occurrence → **Trigger occurrence** → After trigger occurrence

Automatic generation of reports including graphs

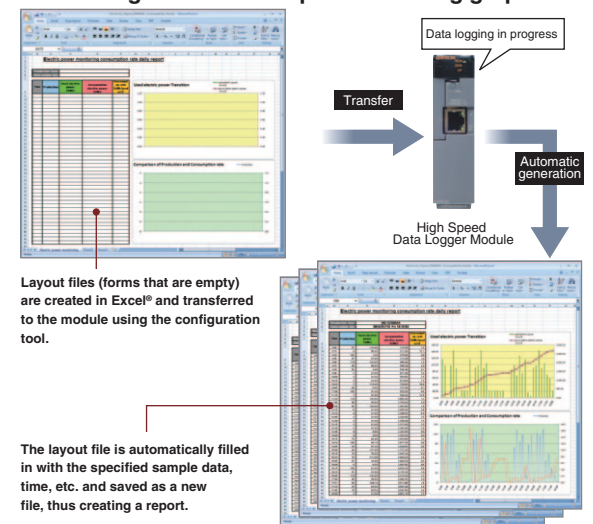

The layout file is automatically filled in with the specified sample data, time, etc. and saved as a new file, thus creating a report.

Supporting productivity and enhanced device value through real-time transfer of control data

● High speed data communication module QJ71DC96

» High data accuracy communication from the programmable controller to the personal computer can be easily realized with the high-speed data communication module (QJ71DC96). Data can be streamed at high speed to the personal computer by synchronizing with the controller scan cycle without having to continuously poll data as was previously achieved. This feature realizes improved productivity by resulting in real-time control data analysis on the personal computer.

Fast and reliable large data transfer in real-time

- Transfer of large data volumes across a very short sampling period can be realized with “Streaming transfer” feature. High data integrity can be easily achieved across TCP/IP Ethernet to personal computer based servers.

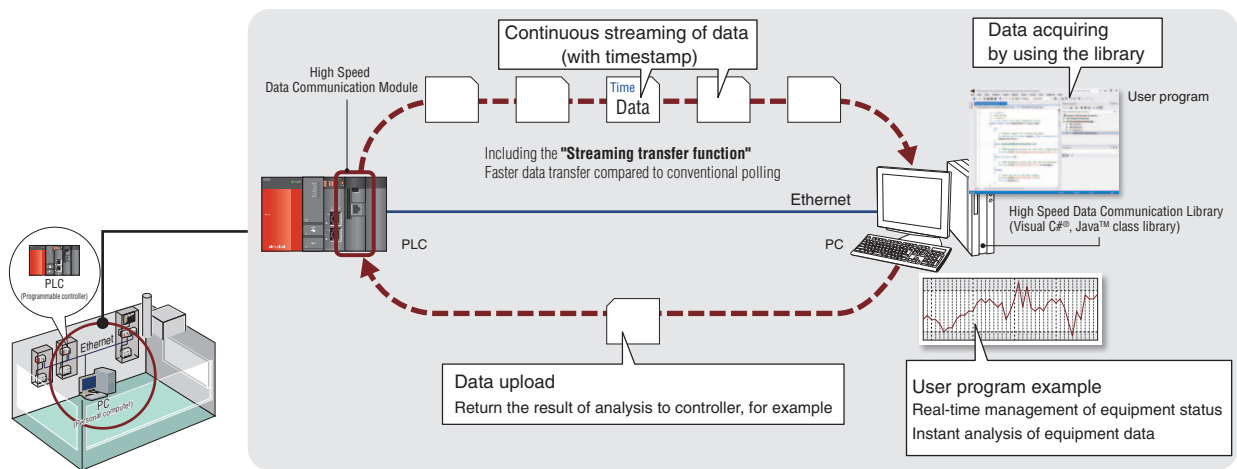

Data acquisition without considering protocol

- Communication between the module and a personal computer is provided in the form of Visual C#® and Java™ class libraries. These class libraries enable a simple personal computer program to acquire data from the programmable controller without considering the communication protocol.

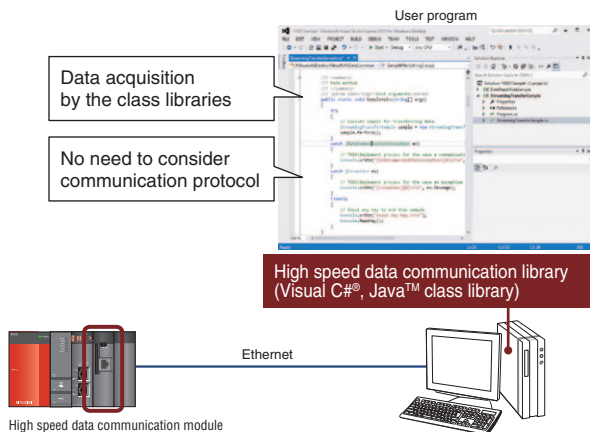

Labels for effective data sampling

- Labeling (naming) each personal computer data makes classifications of transferring data simple. Multiple labels are grouped and sorted as label groups by equipment or user. Label group access control corresponding to user levels is also possible.

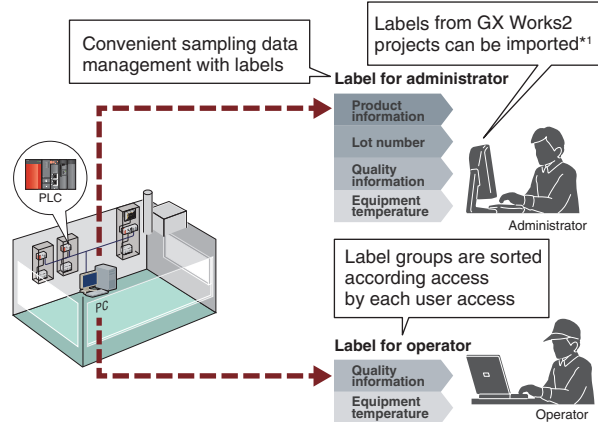

*1: The engineering software GX Works2 Version 1.44 W or later is required when the global labels of GX Works2 project are imported to the Configuration Tool of this module.



Ethernet and CC-Link IE Field related products

● **Wireless LAN adapter** Ethernet

NZ2WL-US (U.S.A)^{*1*2}, NZ2WL-EU (Europe)^{*1*2}, NZ2WL-CN (China)^{*1*2}, NZ2WL-KR (Korea)^{*1*2}, NZ2WL-TW (Taiwan)^{*1*2}

- » Wireless LAN (Ethernet) in the factory provides flexibility in installing new line or alteration layouts. Wireless saves your wiring costs.
- » Simply installing wireless LAN adapters makes existing FA equipment wireless.
- » Compatible with the latest security standards of WPA2/WPA.
- » The security prevents unauthorized access from outside.

^{*1}: Each product can be used only in the respective countries.
^{*2}: Supported both Access point and Station. They can be used by changing the setting.

The wireless LAN adapters were developed and are produced with CONTEC Co., Ltd. Please note that the general specifications and guarantee conditions of these products are different from those of programmable controllers (such as MELSEC Series) and CONTEC products. Refer to the manual for details on the product.



● **Industrial switching HUB** CC-Link IE Field Ethernet

NZ2EHG-T8, NZ2EHF-T8^{*3}

- » NZ2EHG-T8 is compatible with transmission rates of 10 Mbps, 100 Mbps, and 1 Gbps.
- » NZ2EHF-T8 is compatible with transmission rates of 10 Mbps and 100 Mbps.
- » These switching hubs comply with IEEE802.3ab (1000BASE-T), IEEE802.3u (100BASE-TX), IEEE802.3 (10BASE-T) standards.
- » AutoMDI/MDI-X and auto-negotiation are available.
- » The automatic power adjustment function can reduce power consumption by up to 80 percent.^{*4}
- » These hubs do not use cooling fans, and yet a wide ambient-temperature operating range is permissible (0 to 50°C).
- » Quick detach mechanism allows easy DIN rail attachment and detachment.

^{*3}: This model may not be connected directly to the CC-Link IE Field Network (1 Gbps). An Ethernet adapter module NZ2GF-ETB is required. For direct use with the CC-Link IE Field Network, please use NZ2EHG-T8.
^{*4}: For comparison, power consumption was measured when all 8 ports were used and when none of them were used. This function is only available for NZ2EHG-T8.

This series was developed and is produced with Contec Co. Ltd. Please note that the specifications and guarantee conditions of these products are different from those of MELSEC products. Please refer to the product manual for details.

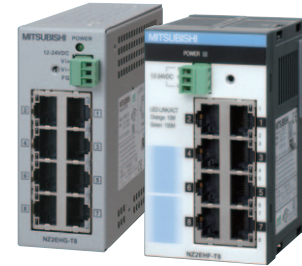

1 Gbps 100 Mbps

● **CC-Link IE Field Network Ethernet adapter module** CC-Link IE Field Ethernet

NZ2GF-ETB

- » Using Seamless Message Protocol (SLMP^{*5}), a variety of Ethernet devices such as vision sensors and RFID controllers can be connected to the CC-Link IE Field Network.
- » Use a web browser to set station numbers, Ethernet options, and view error history.
- » This Ethernet adapter module is compatible with transmission rates of 100 Mbps and 1 Gbps.

^{*5}: SLMP (SeamLess Message Protocol) is a protocol advocated by the CC-Link Partner Association.



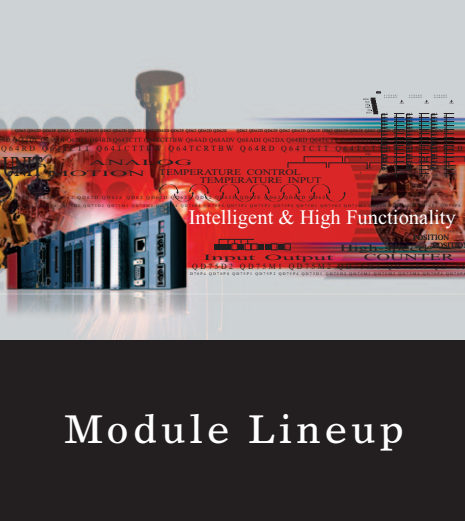

Comprehensive range of I/O and intelligent function modules.

The Q Series I/O and intelligent function module lineup is extensive and capable of meeting the needs of a wide range of applications. Some of the available modules include motion control, serial communication, temperature control, temperature input, standard digital and analog I/O modules, and channel isolated analog modules. Attain the ideal solution for the application, whether it be high speed positioning or high accuracy temperature control.

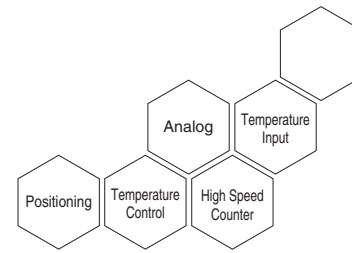

Input/Interrupt modules

Point	DC input					DC/AC input	AC input	
	5 V DC		5/12 V DC	24 V DC		48 V DC/AC	100...120 V AC	100...240 V AC
	Positive	Negative	Positive/Negative	Positive	Negative	Positive/Negative		
8 points	—	—	—	QX48Y57*1		—	—	QX28
16 points	QX70H	QX90H	QX70	QX40 QX40-TS QX40-S1 QX40H QI60	QX80 QX80H QX80-TS	QX50	QX10 QX10-TS	—
32 points	—	—	QX71	QX41 QX41-S1 QX41-S2 QH42P*1 QX41Y41P*1	QX81 QX81-S2	—	—	—
64 points	—	—	QX72	QX42 QX42-S1	QX82 QX82-S1	—	—	—

*1: Input specifications for I/O combined modules

Output modules

Point	Contact output	TRIAC output	Transistor output				
	24 V DC, 240 V AC	100...240 V AC	5...12 V DC	5...24 V DC		12...24 V DC	
			Sink type	Sink type	Sink/Source type	Sink type	Source type
7 points	—	—	—	—	—	QX48Y57*2	—
8 points	QY18A	—	—	—	QY68A	—	—
16 points	QY10 QY10-TS	QY22	QY70	—	—	QY40P QY40P-TS QY50	QY80 QY80-TS
32 points	—	—	QY71	QY41H	—	QY41P QH42P*2 QX41Y41P*2	QY81P
64 points	—	—	—	—	—	QY42P	QY82P

*2: Output specifications for I/O combined modules

- High speed DC input module (positive common type)QX40H, QX70H
- High speed DC input module (negative common type)QX80H, QX90H

Speed up control by catching the input signal variation at 0 ms*3. Two devices with differing power systems can be connected to the same module using different 8 point common terminals.

*3: The actual response time is 5 μs delay when turning ON, 10 μs delay when turning OFF, because the hardware response time is added.

Common type	Input voltage	
	24 V DC	5 V DC
Positive	QX40H	QX70H
Negative	QX80H	QX90H

- Spring clamp terminal block type input moduleQX10-TS, QX40-TS, QX80-TS
- Spring clamp terminal block type output moduleQY10-TS, QY40P-TS, QY80-TS

Spring clamp terminal blocks visually indicate the connection status. Also, by eliminating screws, wiring and maintenance work is made easier.

Advantages of spring clamp terminal blocks

- Impervious to vibration, secured wiring connections.
- Eliminating screws greatly simplifies conventional maintenance.

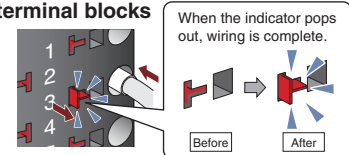

Wiring connections are easily confirmed by high-contrast indicators.

Analog modules

Number of channels	Channel isolated	Analog input							Analog output	
		Voltage input	Current input	Signal conditioning	Load cell	CT input	Temperature input		Voltage output	Current output
							Temperature input	RTD		
1	●	—	—	—	Q61LD	—	—	—	—	
2	●	—	—	Q62AD-DGH	—	—	—	—	Q62DA-FG	
	—	—	—	—	—	—	—	—	Q62DAN Q64AD2DA	
4	●	Q64AD-GH		—	—	—	Q64TD Q64TDV-GH	Q64RD-G	—	
	—	Q64AD Q64ADH Q64AD2DA		—	—	—	—	Q64RD	Q64DAN Q64DAH	
6	●	—	—	Q66AD-DG	—	—	—	—	Q66DA-G	
8	●	Q68AD-G		—	—	—	Q68TD-G-H01 Q68TD-G-H02	Q68RD3-G	—	
	—	Q68ADV	Q68ADI	—	—	Q68CT	—	—	Q68DAVN Q68DAIN	

Temperature control modules

Number of channels	Wire break detection	Input	
		Thermocouple	RTD
4	●	Q64TCTTBWN	Q64TCRTBWN
	—	Q64TCTTN	Q64TCRTN

Loop control module

Number of channels	Input			
	Voltage	Current	Thermocouple	RTD
2	Q62HLC			

Simple motion modules

Number of axes	SSCNET III/H	CC-Link IE Field
2	QD77MS2	—
4	QD77MS4	—
16	QD77MS16	QD77GF16

Positioning modules

Number of axes	Specialised functionality type				Simple control and fast-response type			Built-in counter function type
	Open collector output	Differential drive output	SSCNET III	SSCNET	Open collector output	Differential drive output	SSCNET III	Open collector output
1	QD75P1N	QD75D1N	QD75MH1	QD75M1	—	—	—	—
2	QD75P2N	QD75D2N	QD75MH2	QD75M2	—	—	—	—
3	—	—	—	—	—	—	—	QD72P3C3
4	QD75P4N	QD75D4N	QD75MH4	QD75M4	QD70P4	QD70D4	—	—
8	—	—	—	—	QD70P8	QD70D8	QD74MH8	—
16	—	—	—	—	—	—	QD74MH16	—

Pulse input/high-speed counter modules

Number of channels	Maximum counting speed	Channel isolated	Input specifications			
			5 V DC	12 V DC	24 V DC	Differential drive output
2	2-phase input	—	QD62 QD62E QD65PD2			—
			—	—	—	QD62D
			—	—	—	QD64D2
			—	—	—	QD65PD2
6	2-phase input	—	QD63P6	—	—	
8	1-phase input	●	QD60P8-G			—

Energy measuring module

Number of channels	Energy measuring	Insulation monitoring
1	QE81WH QE81WH4W	—
2	—	QE82LG
3	QE83WH4W	—
4	QE84WH	—

A wide range of application specific intelligent modules

A range of analog modules ideal for process control applications.

Isolated analog modules suitable for process control

- Channel isolated high resolution analog-digital converter module **Q64AD-GH**
- Channel isolated high resolution analog-digital converter module **Q62AD-DGH**
- Channel isolated high resolution digital-analog converter module **Q62DA-FG**
- Channel isolated analog-digital converter module **Q68AD-G**
- Channel isolated analog-digital converter module (with signal conditioning function)..... **Q66AD-DG**
- Channel isolated digital-analog converter module **Q66DA-G**

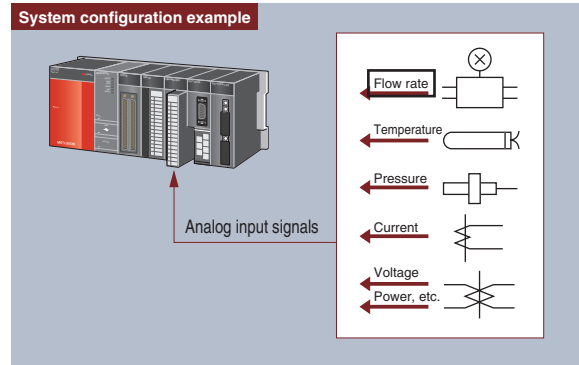

The channel isolated analog modules are specifically designed for process control applications by offering high accuracy conversion combined with high isolation voltage. Flow meters, pressure gauges, etc. can be directly connected to the analog input, and control valves to the analog output. Hardware and installation costs can be substantially reduced because external isolation amplifiers are not required. When used with a general purpose controller, a low cost process control solution can be created.

High dielectric withstand voltage

- Electric disturbances such as current and noise can be isolated.
- Standard analog input module
- Isolated analog input module

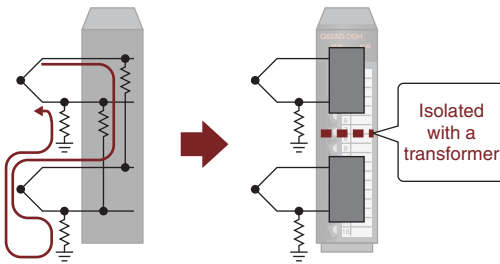

- External signal converters are not required.
- Without channel isolated analog module
- With channel isolated analog module

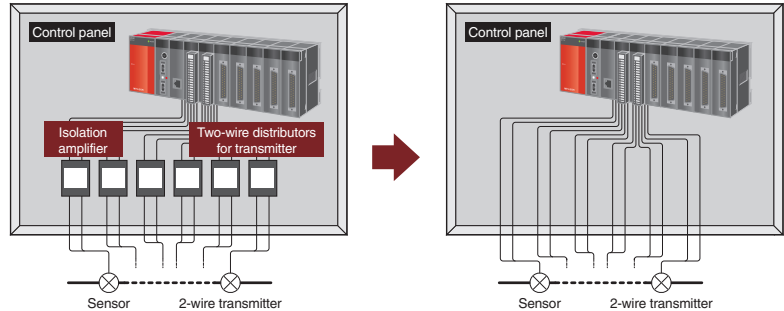

High conversion speed analog modules

- High speed analog-digital converter module..... **Q64ADH**
- Analog-digital converter module**Q68ADV, Q68ADI**
- High speed digital-analog converter module.....**Q64DAH**
- Digital-analog converter module
Q62DAN, Q64DAN, Q68DAVN, Q68DAIN
- Analog-digital/Digital-analog converter module**Q64AD2DA**

Many high-speed A/D and D/A conversion (analog) modules are available. These modules are feature packed to allow maximum flexibility when connecting to devices. Both speed and accuracy are great enough to control sensitive motion applications using servos or inverters.

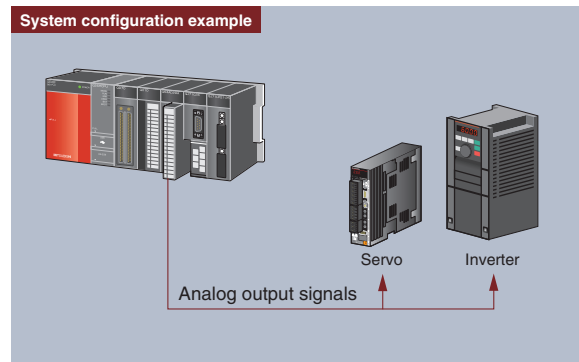



High accuracy temperature input modules

● Temperature input module

- Thermocouple input module **Q64TD, Q64TDV-GH, Q68TD-G-H01, Q68TD-G-H02**
- RTD input module **Q64RD, Q64RD-G, Q68RD3-G**

Temperature data can be captured by connecting a thermocouple or a resistance temperature detector. Multi-channel (8-channel) input types and channel-isolated types are available. An optimum model for the intended application can be selected.

System configuration example

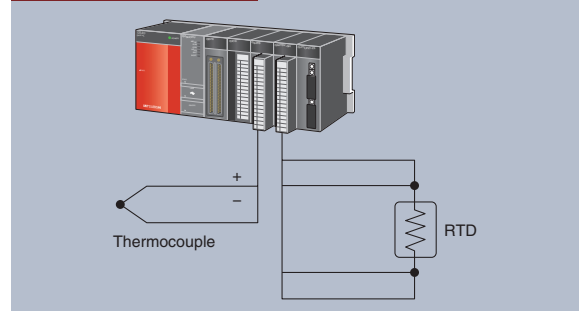

PID loop control integrated temperature control modules

● Temperature control module

- Thermocouple input module **Q64TCTTN, Q64TCTTBWN**
- Platinum RTD input module **Q64TCRTN, Q64TCRTBWN**

The devices which require high stability of temperature control such as extrusion forming machines, these modules prevent overheating and overcooling. The standard control (heating or cooling) or heating-cooling control (heating and cooling) mode can be selected depending on the machine to be controlled.

In addition, the mixed control mode (combination of standard control and heating-cooling control) can be selected.

System configuration example

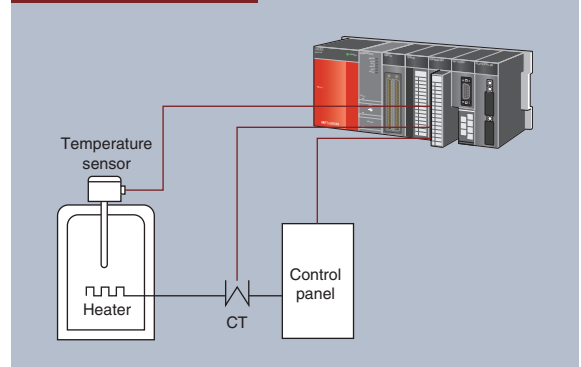

● Peak current suppression function

This function avoids simultaneously turning on outputs to control the peak current. It can save energy and reduce the running cost.

● Simultaneous temperature rise function

This function allows several loops to reach the set value at the same time to conduct uniform temperature control.

It prevents idling and is effective in saving energy and reducing running cost.

● Self-tuning function

The PID constant is automatically adjusted during control.

The automatic tuning cost (time, materials and power) can be reduced.

Loop control module ideal for temperature and flow rate control environments which require fast response

● Loop control module **Q62HLC**

With its speed-proportional PID control format and 25 ms sampling cycle, the loop control module is well suited for high-precision, high-resolution thermocouple inputs, micro voltage inputs, voltage inputs, current inputs, and current outputs. It is also ideal for sudden temperature change control, pressure control, and flow control applications which require fast response.

- Connectable to JIS, IEC, NBS, ASTM standards compliant thermocouples.
- Permits analog value measurements of various input ranges by using micro voltage, voltage, and current input sensors.
- Offers program control while automatically changing the target values (SV) and PID constants [proportional band (P), integral time (I), derivative time (D)] in a time-specific manner, as well as a cascade control function that permits control with CH 1 as the master, and CH 2 as the slave.

System configuration example

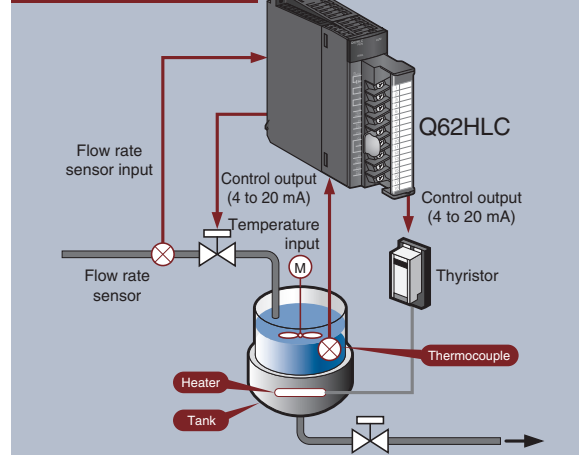

Interface with all types of load cell with the load cell I/P module

● Load cell input module **Q61LD**

Load cells can now be directly connected to the programmable controller system without requiring an external signal converter. The module achieves highly accurate measurement with steady data conversion speed that guarantees the accuracy of load cells.

Separate signal converter not required!

Reduce engineering costs by directly connecting a load cell to the programmable controller!

- Any type of load cell*1 such as magnetostriction, capacitive, gyroscope, or strain gauge.
- 6-wire system (combination of remote sensing and ratiometric methods) or 4-wire system load cells.

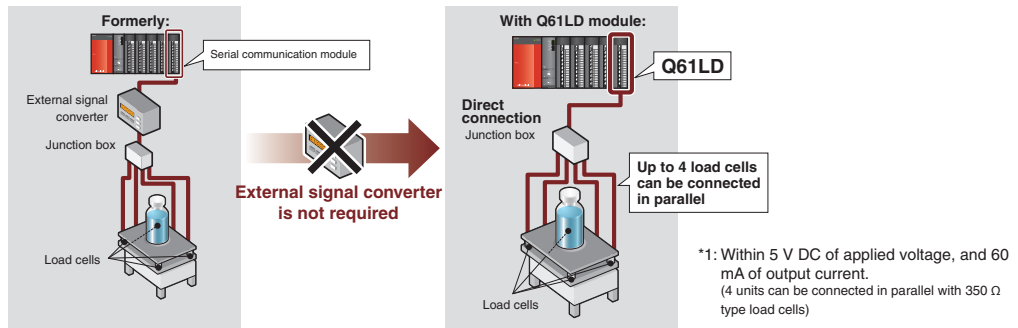

- Applications requiring high accuracy can be achieved by connecting the load cell directly to the programmable controller.

- Nonlinear accuracy: Within $\pm 0.01\%$ /FS
 - Zero drift: Within $\pm 0.25 \mu\text{V}/^\circ\text{C}$ RTI
 - Gain drift: Within $\pm 15 \text{ ppm}/^\circ\text{C}$
- (Load cell rated output is 2 mV/V, ambient temperature is 25°C, and the tare weight subtraction function is not used.)

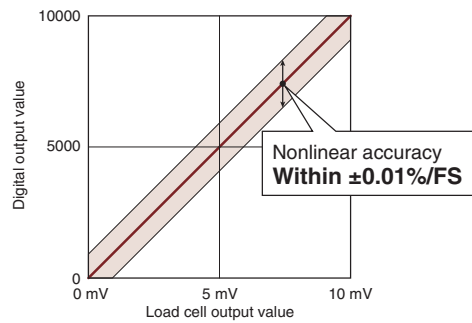

Zero offset function

This function subtracts the tare weight automatically relative to the load cell usage range when calibrating measuring instruments. Using this function can improve the accuracy of the measuring instrument.

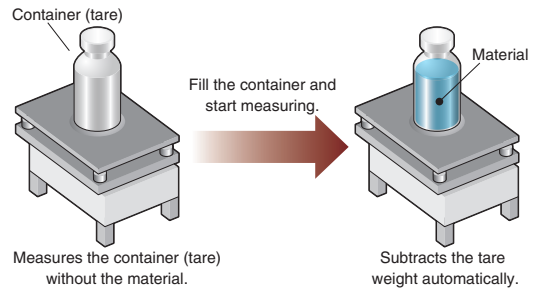

Static load calibration function

The gross weight value can be accurately calibrated by applying the actual load (weight) onto the load cell.

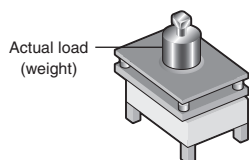

Input signal error detection function

Load cell input signal errors can be detected.

- Input signal error
- Weight capacity over error
- Zero point out of range
- Exceed conversion error

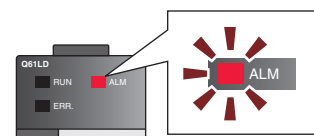



Direct CT sensor connection reduces wiring and saves space

● CT input module **Q68CT**

The direct connection of the CT sensor*1 and the programmable controller has eliminated the need to connect a separate signal converter. Very accurate measurements can be achieved with stable data conversion speed for load control of systems and devices, monitoring of operations, and control and monitoring of power systems.

*1: The CT (Current Transformer) sensor refers to an instrument transformer, a current sensor is essential for measuring alternating currents.

Direct CT sensor connection reduces wiring and saves space

- Directly connect to the CT sensor without an external signal converter. The AC current for up to eight channels can be measured with one unit, by that reducing the wiring steps and costs.
- Set the CT sensor type (input range) for each channel. CT sensors with 0 to 5 AAC or 0 to 600 AAC can be used by one unit.

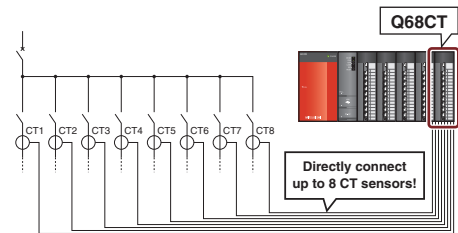

Predictive maintenance of devices by detecting the peak current!

Peak current detection function

- The device can be serviced and troubleshooting performed by detecting the peak current. With a motor for example, the load applied on the motor is changed by the gear wear and damage, and the load current suddenly changes. The device trouble can be diagnosed by detecting the transient peak current at this time.

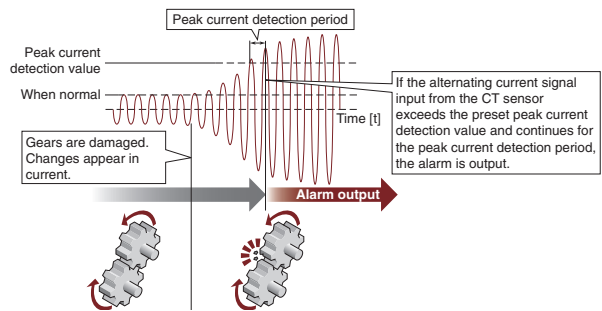

Input signal error detection function

- Over-range (peak value over) of the CT input value can be detected. Since the flow of a large current exceeding the range of the measurement target can be detected, errors in the measurement target can be monitored.

Input range setting	Detection level
0...5 A (AC)	Approximately 6.25 A (AC)
0...50 A (AC)	Approximately 62.5 A (AC)
0...100 A (AC)	Approximately 125 A (AC)
0...200 A (AC)	Approximately 250 A (AC)
0...400 A (AC)	Approximately 500 A (AC)
0...600 A (AC)	Approximately 750 A (AC)

Connectable CT sensors

Model	Manufacturer	Analog input range
EMU-CT50	Mitsubishi Electric Corporation	0...50 A (AC)
EMU-CT100		0...100 A (AC)
EMU-CT400		0...400 A (AC)
EMU-CT600		0...600 A (AC)
CTF-5A	Multi Measuring Instruments Co., Ltd. (introduced products)	0...5 A (AC)
CTF-50A		0...50 A (AC)
CTF-100A		0...100 A (AC)
CTF-200A		0...200 A (AC)
CTF-400A		0...400 A (AC)
CTF-600A		0...600 A (AC)
CTL-10-3FC	U.R.D. Co., Ltd. (introduced products)	0...5 A (AC), 0...50 A (AC)
CTL-16-3FC		0...100 A (AC)
CTL-24-3FC		0...200 A (AC)
CTL-36-6SC		0...400 A (AC)
CTL-36-9SC		0...600 A (AC)

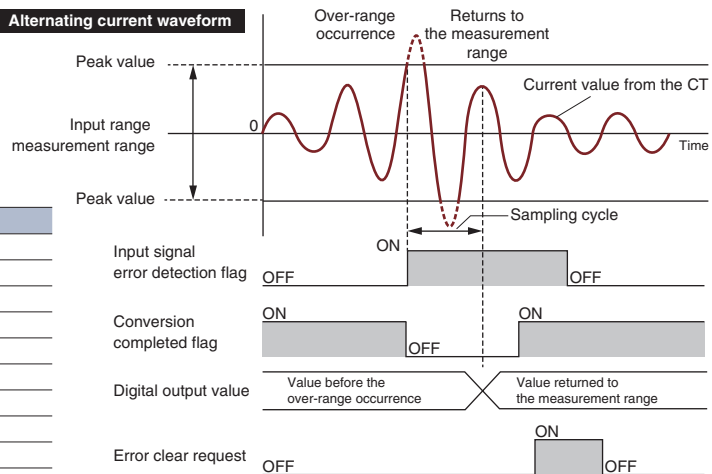

Simple motion module for positioning control and synchronous control.

Advanced control but simple use as the positioning module

Speed/torque control and synchronous control are supported in addition to the traditional positioning control. Using the “simple motion module setting tool”, operations such as positioning setting, monitoring and debugging can be performed easily. In addition, collection of data synchronized with the motion controller can be collected and displayed in waveform.

● Simple motion module

SSCNET III/H connection type QD77MS□

The □ in the above model indicates the number of axes (2, 4, 16).

The SSCNET III/H connection reduces wiring, enables connections of up to 100 m between stations, and easily supports absolute position settings. The upper limit LS, lower limit LS, and near-point dog signals can be input from the servo amplifier, thus greatly reducing wiring. In addition to positioning control and speed control, processes such as synchronous control, cam control, torque control and tightening & press-fit control can be performed.

High compatibility with conventional models, projects and sequence programs for the positioning module (QD75MH) can be used easily in the simple motion module (QD77MS) projects.

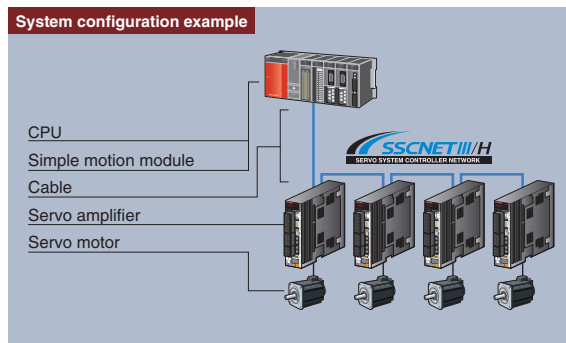

		QD77MS2	QD77MS4	QD77MS16
Maximum number of control axes		2-axes	4-axes	16-axes
Servo amplifier connection method		SSCNET III/H		
Maximum distance between stations		100 m		
Control system		PTP (Point to Point) control, path control (both linear and arc can be set), speed control, speed/position switching control, position/speed switching control, synchronous control, cam control, torque control, tightening & press-fit control		
Starting time	1-axis linear control	0.88 ms	0.88 ms	1.77 ms
	1-axis speed control			
	2-axes linear interpolation control			
	2-axes circular interpolation control			
	2-axes speed control	—	—	—
	3-axes linear interpolation control			
	3-axes speed control			
	4-axes linear interpolation control			
4-axes speed control				

CC-Link IE Field Network connection type QD77GF16

The simple motion module supports the general purpose CC-Link IE Field Network, with its flexible wiring. This module can be used as the CC-Link IE Field's master station (QJ71GF11-T2 or equivalent)*1 while retaining the simple motion module's functions. This realizes flexible networking supporting connection to various devices such as HMI (GOT), remote I/O, inverter, etc.

*1: QD77GF16 master station transmission style can use the line type or star type. Up to 104 slave devices can be connected to one network.

*2: The setting and diagnosis function using GX Works2 is disabled.

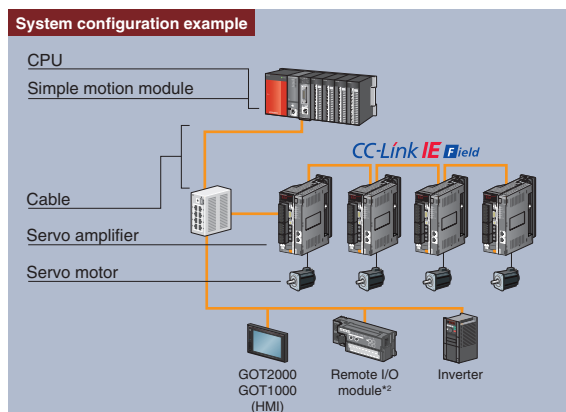

		QD77GF16	
Maximum number of control axes		16-axes	
Servo amplifier connection method		CC-Link IE Field Network	
Maximum distance between stations		100 m	
Control system		PTP (Point to Point) control, path control (both linear and arc can be set), speed control, speed/position switching control, position/speed switching control, synchronous control, cam control	
Starting time	1-axis linear control	0.88 ms	1.77 ms
	1-axis speed control		
	2-axes linear interpolation control		
	2-axes circular interpolation control		
	2-axes speed control	1.77 ms	3.55 ms
	3-axes linear interpolation control		
	3-axes speed control		
	4-axes linear interpolation control		
4-axes speed control	3.55 ms	7.11 ms	



A large selection of motion control solutions are available to fit any motion application.

High-speed, accurate positioning control

Various types of motion control are supported including 2 to 4-axes linear interpolation, 2-axes circular interpolation, speed control, speed/position changeover, path control and constant speed control. Making settings (including positioning data), monitoring, and debugging is made much easier using GX Works2's built-in intelligent function module tools or the stand-alone tool, GX Configurator-QP. For servo control, Q Series leverages the benefits of SSCNET, a Mitsubishi high performance motion control network. This allows Mitsubishi intelligent digital servos to be connected by a simple daisy chain cable that reduces cost and increases performance.

● Positioning module

SSCNET III connection type..... QD75MH□

The □ in the above model indicates the number of axes (1, 2, 4).

Using SSCNET III optical cables minimizes the required wiring, permits distances of up to 50 m between stations, and is highly resistant to EM/RFI. This format is also compatible with absolute position systems where the home position is established by a home position return data setting operation. Using the CN3 connection, limit switches and proximity DOG inputs can be made directly to the servo amplifier, greatly reducing the required wiring.

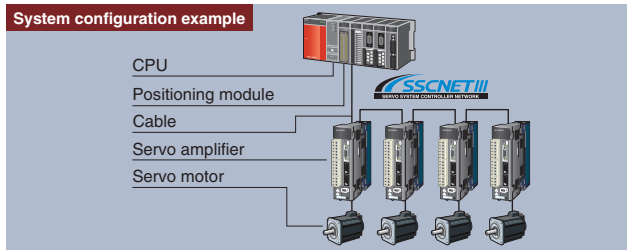

	QD75MH□	QD75M□
Servo amplifier connection method	SSCNET III	SSCNET
Max. distance between stations	50 m	30 m
Control system	PTP (Point To Point) control, path control (both linear and arc can be set), speed control, speed-position switching control, position-speed switching control	
Starting time ^{*1}	1-axis linear control	3.5 ms
	1-axis speed control	3.5 ms
	2-axes linear interpolation control	4.0 ms
	2-axes circular interpolation control	4.0 ms
	2-axes speed control	3.5 ms
	3-axes linear interpolation control	4.0 ms
	3-axes speed control	3.5 ms
	4-axes linear interpolation control	4.0 ms
4-axes speed control	4.0 ms	

*1: Using the pre-reading start function, the actual starting time can be shortened.

● Positioning module

Open collector pulse train output type QD75P□N

Differential driver pulse train output type QD75D□N

The □ in the above model indicates the number of axes (1, 2, 4).

For compatibility with the widest range of motion hardware, both open collector and differential driver type positioning modules are available. Transmission of high-speed pulses, up to 4 Mpps, to a servo amplifier can be made reliably up to 10 meters away. These pulse train output positioning modules can provide a high level of speed and accuracy for practically any application.

	QD75P□N	QD75D□N
Pulse train output format	Open collector output	Differential drive output
Max. output pulse	200 kpps	4 Mpps
Max. connection distance to drive unit	2 m	10 m
Control system	PTP (Point To Point) control, path control (both linear and arc can be set), speed control, speed-position switching control, position-speed switching control	
Starting time ^{*2}	1-axis linear control	1.5 ms
	1-axis speed control	1.5 ms
	2-axes linear interpolation control	1.5 ms
	2-axes circular interpolation control	2.0 ms
	2-axes speed control	1.5 ms
	3-axes linear interpolation control	1.7 ms
	3-axes speed control	1.7 ms
	4-axes linear interpolation control	1.8 ms
4-axes speed control	1.8 ms	

*2: Using the pre-reading start function, the actual starting time can be shortened.

● Positioning module

SSCNET connection type QD75M□

The □ in the above model indicates the number of axes (1, 2, 4).

Connections made using SSCNET greatly reduce the required wiring compared to traditional systems. Not only can servo amplifiers be daisy chained together, but motion control input signals like proximity DOG, etc. can be wired directly to the servo amplifier. Absolute position system implementation is fully supported, and zero point return (OPR) may be executed using a data set.

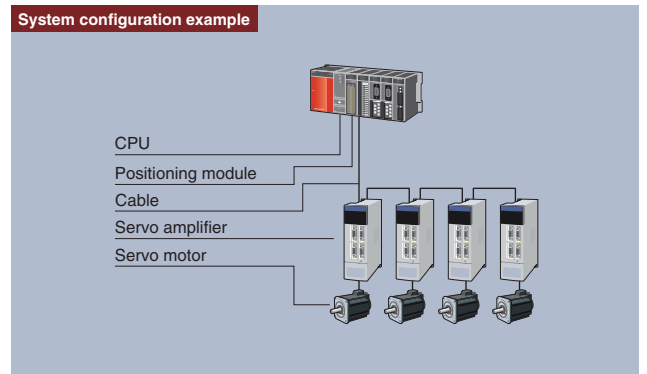

Application example ▶ Sealing

Function

- Constant speed pass control
- Linear, circular interpolation
- High-speed, high-accuracy pass control

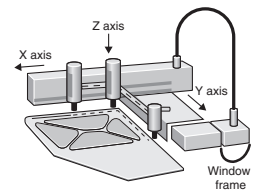
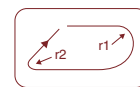

System configuration example

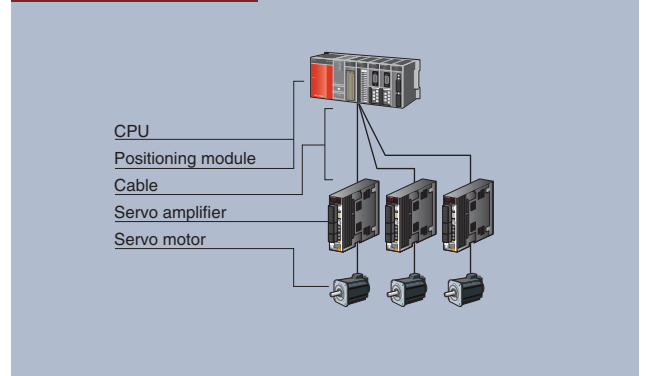

Application example ▶ X-Y table control

Function

- 2-axes linear interpolation
- 3-axes linear interpolation
- 2-axes circular interpolation
- Constant speed pass control

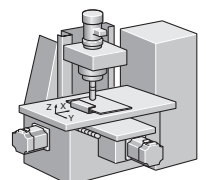

The ideal solution for simple multi-axis positioning

These modules are ideal for high-speed linear positioning control in a multi-axis system. Easily satisfying the requirements for simple positioning control applications, these modules include functions, such as positioning control, speed control and variable positioning control.

● Positioning module

SSCNET III connection type.....**QD74MH□**

The □ in the above model indicates the number of axes (8, 16).

Control up to 16-axes with a single module. The long list of functions includes positioning to an arbitrary position, incremental feed control, location control, a high-speed operating cycle, SSCNET III connectivity, electronic gears, backlash compensation, absolute position system, and linear interpolation of up to 4-axes.

		QD74MH□
Servo amplifier connection method		SSCNET III
Max. distance between stations		50 m
Control system		PTP (Point To Point) control, path control (linear only)
Starting time	1-axis linear control	0.88 ms
	2-axes linear interpolation control	
	3-axes linear interpolation control	
	4-axes linear interpolation control	

● Positioning module

Open collector pulse train output type.....**QD70P□**

Differential driver pulse train output type.....**QD70D□**

The □ in the above model indicates the number of axes (4, 8).

These modules are a great match for stepper motor control. Acceleration and deceleration can be performed smoothly with very fine changes in speed. "Fast start processing" is a basic feature that allows for a single axis positioning start time of just 0.1 ms.

		QD70P□	QD70D□
Pulse train output format		Open collector output	Differential drive output
Max. output pulse		200 kpps	4 Mpps
Max. connection distance to drive unit		2 m	10 m
Control system		PTP (Point To Point) control, path control (linear only), speed-position switching control	
Starting time	1-axis start	0.1 ms	
	4-axes simultaneous start*1	0.2 ms	
	8-axes simultaneous start*1	0.4 ms	

*1: When START signal switches ON within 1 scan. There are no start delays between axes.

System configuration example

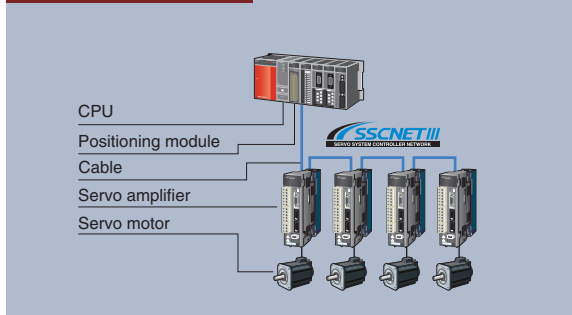

System configuration example

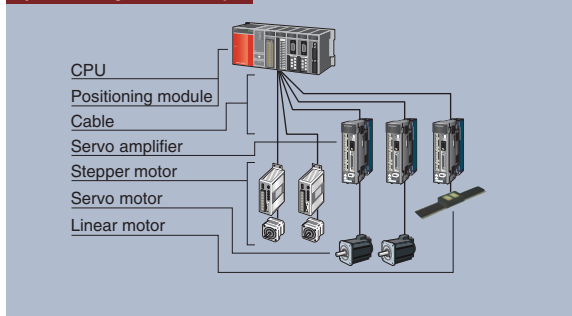

Positioning control using encoder feedback ideal for conveyor systems and processing machines

● Positioning module with built-in counter function

Open collector pulse train output type.....**QD72P3C3**

This module combines counter inputs and pulse outputs for 3-axes in a single module to save space and reduce cost. Several useful functions such as 3-axes simultaneous start, target speed change, and coincidence detection are available.

		QD72P3C3	
Positioning control	Number of axes	3-axes	
	Pulse train output format	Open collector output	
	Max. output pulse	100 kpps	
	Control system	PTP (Point To Point) control, speed control	
	Start time	1-axis start	1 ms
3-axes simultaneous start		1 ms	
Counter function	Number of channels	3 channels	
	Count input signal	Phase	1-phase input, 2-phase input
		Signal level	18 mA at 5 V DC, 2...6 mA at 24 V DC
		Pulse input	1 multiple of 2 phases, 2 multiple of 2 phases, 4 multiple of 2 phases, CW/CCW
Counting speed (max.)	100 kpps		

System configuration example

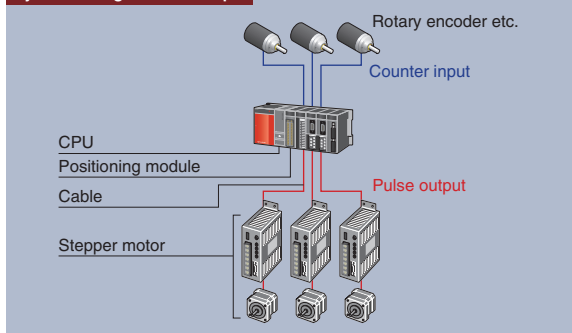

Application example > Conveyor position control

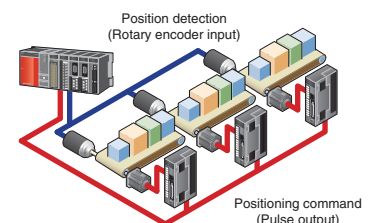



A selection of high-speed pulse counter modules for accuracy intensive, high resolution control applications is available.

Pulse input modules capable of high-speed counting

● High-speed counter module

- Standard type.....**QD62, QD62E, QD62D**
- Multi-channel high-speed counter module **QD63P6**
- 4 Mpps compatible high-speed counter module **QD64D2**
- Multi-function counter/timer module **QD65PD2**

Inputs may be connected to a variety of devices for positioning control, precision measurement, etc. The maximum counting speed may be adjusted via parameter (excluding QD64D2) for more reliable counting at lower frequencies.

- » External coincidence output (QD64D2 includes 2 per channel): Select coincidence output, continuous comparison (QD64D2 only), or the coincidence detection interrupt function for flexible high-speed external device control.
- » Many functions are available to satisfy application requirements including the coincidence output test function (QD64D2 only), latch counter function (excluding QD63P6), and preset function.
- » Calculate pulses at speeds up to 8 Mpps (4 multiples of 2 phases). Perform precise position tracking using a high-resolution encoder for demanding applications such as semiconductor and LCD manufacturing. (QD65PD2)

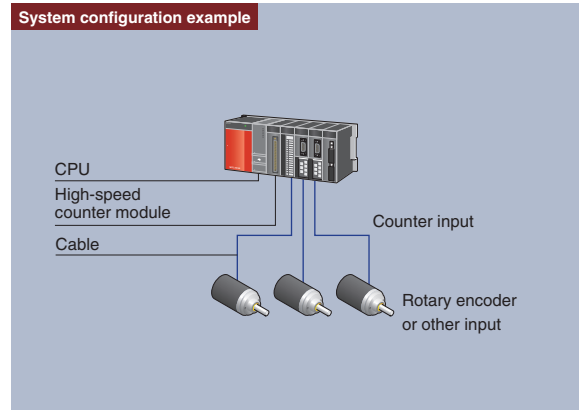

		QD62 (DC input sinking output type)	QD62E (DC input sourcing output type)	QD62D (differential input sinking output type)	QD63P6 (DC input)	QD64D2 (DC input, sink output type)	QD65PD2 (DC/Differential input, external output terminals)
Number of channels		2 channels			6 channels	2 channels	2 channels
Count input signal	Phase	1-phase input, 2-phase input, CW/CCW					
	Signal level	5/12/24 V DC 2...5 mA	EIA Standard RS-422-A Differential line driver level (AM26LS31 [manufactured by Texas Instruments] or equivalent)		5 V DC 6.4...11.5 mA	EIA Standard RS-422-A, differential line driver level (AM26LS31 [manufactured by Texas Instruments Incorporated] or equivalent)	[Differential input] EIA Standards RS-422-A, differential line driver level (AM26LS31 [manufactured by Texas Instruments] or equivalent) [DC input] 5/12/24 V DC, 7...10 mA
	Pulse input	1-phase pulse input (x1, x2), CW/CCW, 2-phase (x1, x2, x4)					
Counting speed (max.)		200 kpps		500 kpps	200 kpps	4 Mpps	[Differential input].....8 Mpps [DC input].....200 kpps
Function		·Linear counter function ·Ring counter function ·Coincidence output function ·Preset function ·Latch counter function ·Count disable function ·Sampling counter function ·Periodic pulse counter function		·Linear counter function ·Ring counter function ·Coincidence detection function ·Preset function ·Periodic pulse counter function	·Linear counter function ·Ring counter function ·Coincidence detection function ·Preset function ·Periodic pulse counter function ·Latch counter function	·Linear counter function ·Ring counter function ·Coincidence output function ·Cam switch function ·Preset/replace function ·Latch counter function ·Count disable function ·Sampling counter function ·Periodic pulse counter function ·Count disable/preset/replace function	·Latch counter/preset/replace function ·Internal clock function ·Frequency measurement function ·Rotation speed measurement function ·Pulse measurement function ·PWM output function ·General input function ·General output function

Multi-function counter/timer module (QD65PD2)

- **Perform extremely accurate position tracking!**
Counting speed up to 8 Mpps (4 multiples of 2 phases)

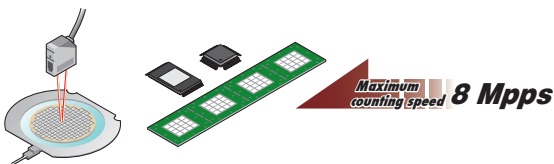

- **Multiple functions designed for ease of use!**
Pulse measurement function
With a resolution of 100 ns, it is possible to perform highly accurate pulse measurement.
PWM output function
Precisely control PWM output up to 200 kHz. With a resolution of 0.1 μs, superfine control of the duty cycle is possible.
Cam switch function
Configure up to 16 cam settings and use up to 8 dedicated outputs. The cam switch function enables highly accurate timing control.
- **Perform sophisticated control using coincidence detection!**
The coincidence output function allows complex applications to be supported. Depending on the situation, either the cam switch function or the coincidence output function can be used.

● Channel isolated pulse input module..... **QD60P8-G**

This module is appropriate for the measurement of input pulse counts (related to speed, revolution, instantaneous flow rate, etc.) and the measurement of quantities (length, cumulative flow, and so forth). The QD60P8-G operates on a 10 ms control cycle, thus the minimum value refresh time is 10 ms. The count cycle setting can be changed to the desired time for cumulative count values and moving average pulse counts (sampling pulse counts).

		QD60P8-G
Number of channels		8 channels
Count input signal	Phase	1-phase input
	Signal level	5 V DC/12...24 V DC, ≥ 4 mA
	Pulse input	1-phase pulse input
Counting speed (max.)		30 k/10 k/1 k/100/50/10/1/0.1 pps

Power measurement units for easily measuring various energy information

Rack installation type energy measuring module

- Energy measuring module.....**QE81WH**
- Energy measuring module (multi-circuit).....**QE84WH**
- Energy measuring module (three-phase 4-wire product).....**QE81WH4W**
- Energy measuring module (multi-circuit, three-phase 4-wire product) ...**QE83WH4W**

Using only one module, highly detailed information about electric energy (consumption and regeneration), reactive energy, current, voltage, electric power, power factor, and frequency can be measured. Minimum and maximum values are constantly monitored and 2 types of upper/lower limit warnings can be implemented without any programming. The amount of electric power used by output devices only while ON can be measured.

The power rate during device operation and the power rate in takt units can be retrieved. The multi-circuit product allows power to be measured in a smaller space as up to four circuits can be measured with a three-phase 3-wire product in one slot, and up to three circuits with a three-phase 4-wire product. For example, one unit can be used to measure other loads from the control panel trunk.

In addition, the parameters can be set easily with GX Works2 (Version 1.91 V and higher).

Model	QE81WH	QE84WH*1	QE81WH4W	QE83WH4W*1
Phase wire system	Single-phase 2-wire/single-phase 3-wire/three-phase 3-wire		Three-phase 4-wire*2	
Instrument rating	Voltage circuit	110 V AC, 220 V AC common (single-phase 2-wire, three-phase 3-wire)		63.5/110 V AC...277/480 V AC
		110 V AC (1 - 2 line, 2 - 3 line) 220 V AC (1 - 3 line) (single-phase 3-wire)		
	Current circuit	Using two-stage configuration in combination with commercially-available voltage transformer (VT). Primary voltage value can be set up to 6,600 V.		
Frequency	50, 100, 250, 400, 600 A AC (Using dedicated split type current sensor. Each value indicates current sensor's primary current value.)			
	5 A AC (Using dedicated 5 A current sensor. 5 A current sensor is used with two-stage configuration in combination with current transformer (CT). Primary current value can be set up to 6,000 A.)			
Number of measurement circuits	1 circuit	4 circuits	1 circuit	3 circuits
Measurement items	Power rate (consumption, regenerative), reactive power rate, period power rate, current, voltage, power, power factory, frequency		Power rate (consumption, regenerative), reactive power rate, period power rate, current, voltage, power, reactive power, apparent power rate, power factory, frequency	

*1: Current measurement mode is provided. Up to eight circuits can be measured when measuring only the current value.

*2: The separate voltage transformer (QE8WH4VT) is required for the three-phase 4-wire compatible products.

Minimal impact on control panel layout

- By installing the energy measuring module onto the open slot of the base unit, measuring instrument can be added without changing the layout in the control panel.

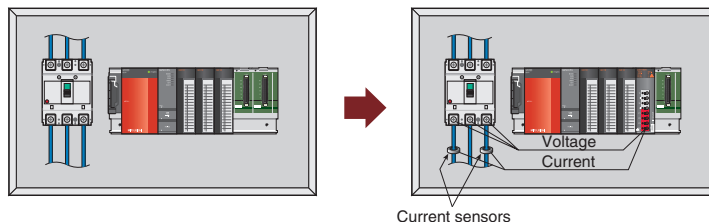

Allows for detailed power measurement at high speed (250 ms)

- Allows for easy specific energy consumption³ management by matching the “production information” of the CPU module with the “energy information” of the energy measuring module.
- Since measured data is automatically collected in a buffer memory at 250 ms, detailed specific energy consumption management is also available.

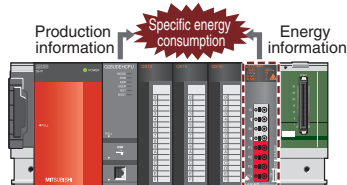

*3: The specific energy consumption is a numerical value displayed by “dividing energy consumption by production volume,” which is one type of index that measures energy productivity. Improving this number leads to improved productivity and energy conservation.

Allows for easy construction of a “visualization” system

- Allows for easy graphic display of specific energy consumption with a GOT (HMI) installed on the control panel at the manufacturing site.
- Combination with the “high-speed data logger module (QD81DL96)” allows specific energy consumption analysis to be easily performed with a personal computer.

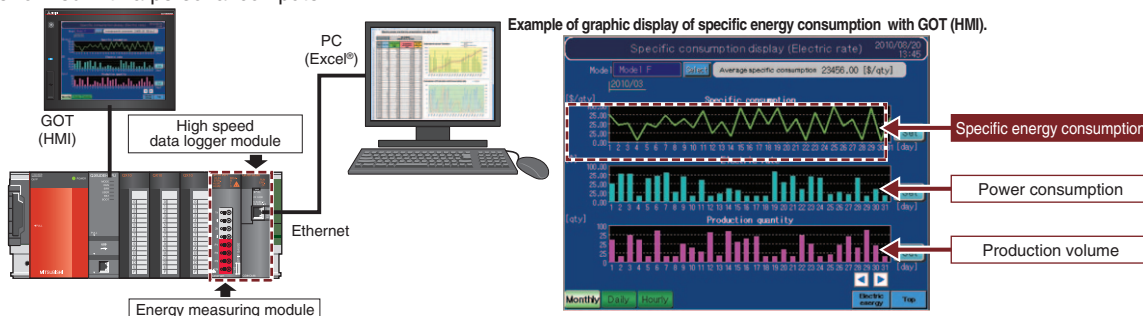



Insulation monitoring module measuring leakage current

● Insulation monitoring moduleQE82LG

Leakage current can be measured for safety measures. Risks of electric shock are detected by monitoring leakage current (I_o).

The isolated state of equipment can be constantly monitored.

The resistive leakage current (I_{or}) is measured to constantly monitor the deterioration of equipment insulation.

Two-stage warning is provided for each measurement item. Two-stage warning for each of leakage current (I_o) and resistive leakage current (I_{or}) can be issued via program-less communication. The two-stage warning function can be used to give a warning for calling for attention and a hazard warning.

One module can monitor two circuits. One module can monitor two circuits of power supplies of the same phase/wire type on the same system.

In addition, the parameters can be set easily with GX Works2 (Version 1.91V and higher).

Measurement items

Leakage current (I_o) and resistive leakage current (I_{or})

Model		Details	
Phase/wire type		Common to single-phase 2-wire and single-phase 3-wire/three-phase 3-wire types	
Instrument ratings	Voltage circuit ^{*1, *2}	Single-phase 2-wire Three-phase 3-wire	Common to 110 V AC and 220 V AC
		Single-phase 3-wire	110 V AC (between wires 1 and 2, between wires 2 and 3), 220 V AC (between wires 1 and 3)
	Leakage current circuit	1 A AC (ZCT is used. Primary current of ZCT)	
	Frequency	50/60 Hz (automatic discrimination of frequency)	
Number of circuits which can be monitored		2 circuits ^{*3}	

*1: The module can be connected directly to 110-V and 220-V power supplies. To connect to a 440-V power supply, an external voltage transformer (VT) is necessary. Leakage current cannot be measured if voltage input is not provided.

*2: Resistive leakage current (I_{or}) can be measured on single-phase 3-wire and three-phase 3-wire delta circuits. On special circuits, such as three-phase 3-wire star circuits, high-resistance grounding circuits and capacitor grounding circuits, only I_o can be measured.

*3: Leakage current (I_o , I_{or}) measurement on CH1 and CH2 can be performed only on circuits on the same system as the voltage input.

Early detection of insulation deterioration of production equipment

- The structure directly connected to programmable controller in the control panel saves space and facilitates measurement of leakage current in places close to loads.
- Failures caused by leakage (earth fault) and insulation of motor loads in production equipment can be monitored. Progression of insulation deterioration is not overlooked.
- The upper limit warning monitor can be set in two stages. Insulation deterioration and condition can be observed at an early stage, so that preventive measures can be taken before production equipment suddenly stops or goes down.

With conventional insulation monitoring device
The system causing leakage can be identified, but insulation deterioration cannot be located.



With this insulation monitoring module
The detailed monitoring of insulation enables to identify faulty units and locate insulation deterioration.

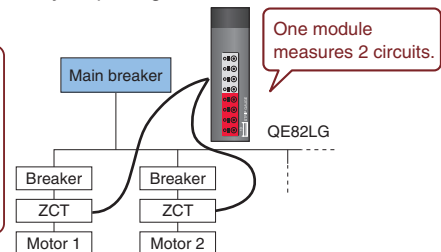

I_{or} method realizes constant monitoring of insulation deterioration of equipment

- With the conventional systems, such as inverter circuits with large capacitive leakage current (I_{oc}), it has difficulty for insulation monitoring.

The module is capable of measuring resistive leakage current (I_{or}), and removes the capacitive leakage current then monitors the accurate leakage current caused by insulation deterioration.

- Resistive leakage current (I_{or}) is constantly measured even during operation of equipment. Signs of insulation deterioration can be detected without power interruption.

Leakage current (I_o) is affected by capacitive leakage current (I_{oc}) of entire equipment.

Therefore, resistive leakage current (I_{or}) measurement is effective in diagnosis of insulation deterioration.

■ Method of measuring leakage current (I_o measurement and I_{or} measurement)

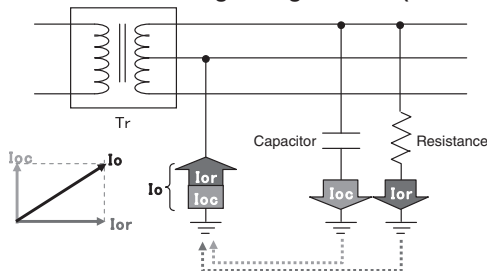

I_{or} : Leakage current caused by insulation deterioration (resistive component in the leakage current)
 I_{oc} : Leakage current (capacitive component of leakage current) flowing even if insulation is in good condition
 I_o : Leakage current obtained by synthesizing I_{or} and I_{oc} (vector synthesis)

- Capacitive leakage current (I_{oc}) fluctuates in equipment with long wiring or equipment with inverter devices and filters

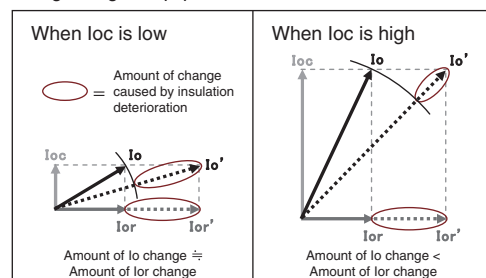

Linking the sensor with the programmable controller

AnyWireASLINK master module QJ51AW12AL DB

The AnyWireASLINK master module links the sensor inputs and outputs to the programmable controller. The module enables flexible layout of sensors with 512 I/O points. The sensor power can be supplied to the AnyWireASLINK transmission line (2-wire) for communication, allowing sensors to be added easily. With the MELSEC-Q/L/F Series, faulty sensors can be detected and the slave module settings can be managed at once by GX Works2 engineering environment, further reducing the engineering time.

AnyWireASLINK

System configuration example

Basic configuration

Either the 2-wire type or 4-wire slave device can be selected according to the load current for AnyWireASLINK. In addition to the 2-wire type, a 4-wire type can also be used by supplying the local power.

2-wire type

If the load current is low, 2-wire type (non-insulated) slave devices can be used without an external power supply.

4-wire type

The 4-wire type (insulated) slave devices require an external 24 V DC power supply to satisfy large load current applications, for example.

Configuration with 2-wire type (with no local power feed)

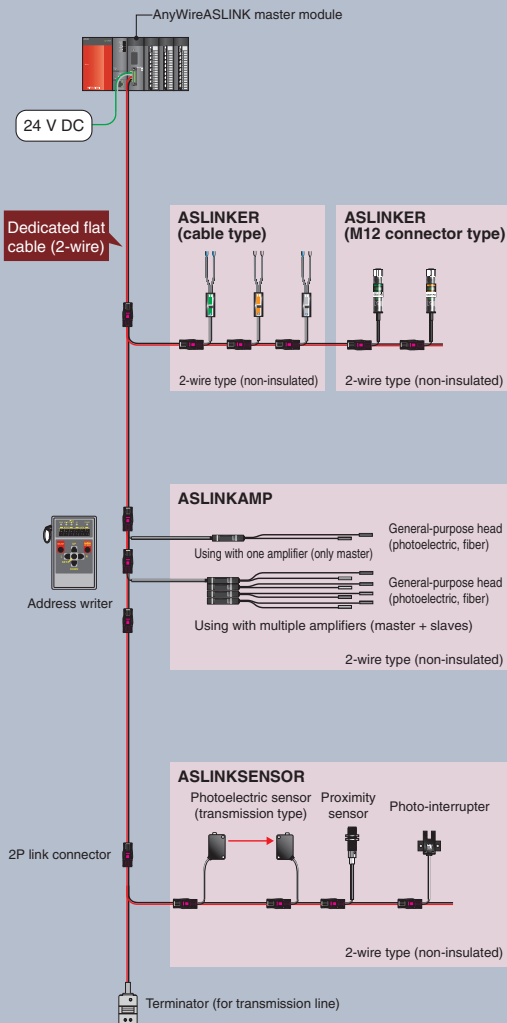

Configuration with 2-wire/4-wire type (with local power feed)

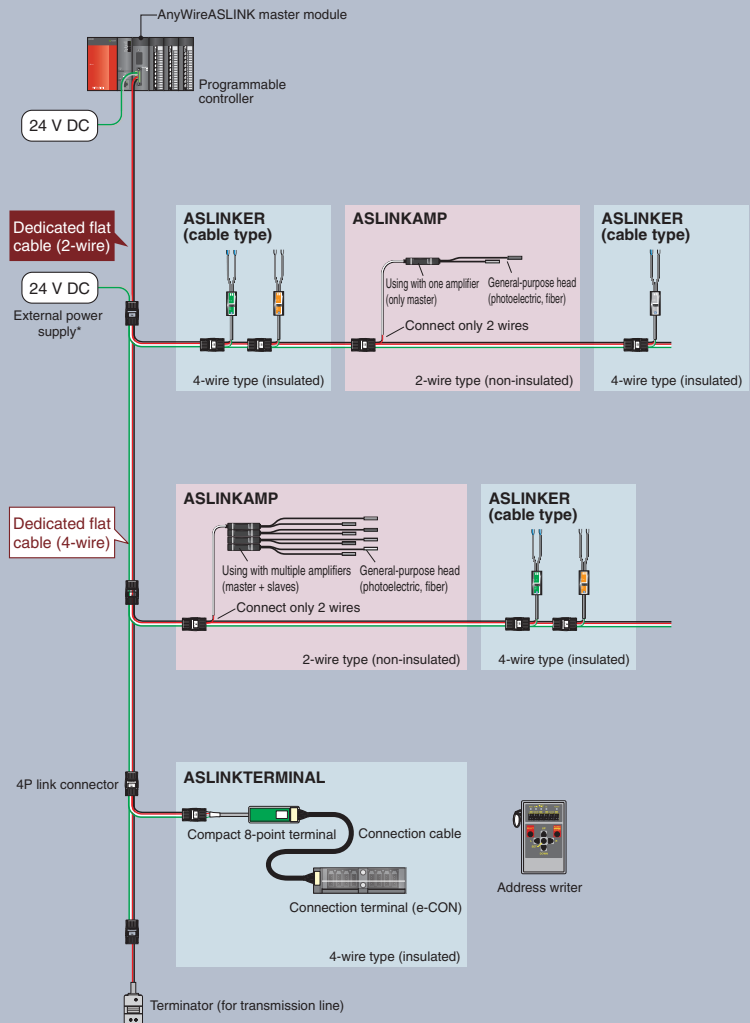

* External power for 4-wire type wiring.



Preventing intermittent operation stops

AnyWireASLINK can be used to monitor and save the sensor information within the programmable controller. Parameter settings of the AnyWireASLINK can also be changed via the programmable controller. Perform “preventive maintenance” with this function to prevent intermittent stops before they happen.

Prevent intermittent stops with preventive maintenance!

- Start maintenance early by checking the incoming light amount.
- Change the ON/OFF sensitivity to keep operating up to the maintenance period.

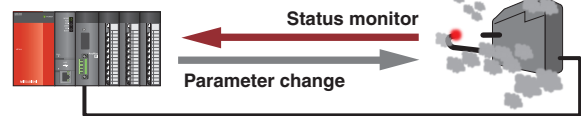
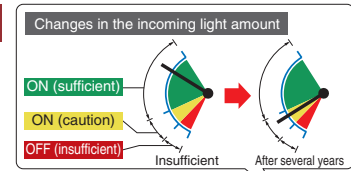

Reducing the setup time, and providing the traceability

AnyWireASLINK enables the set value to be registered at once to multiple sensors via a GOT (HMI) or personal computer. Also, the initial set values can be re-confirmed easily without having to read each sensor individually.

- Register set values to multiple sensors, and automatically read the initial set values.

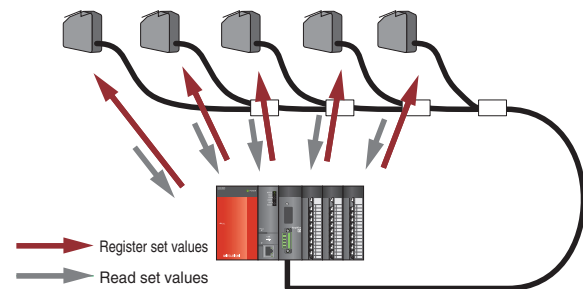

Model	QJ51AW12AL
Number of connected I/O points	Max. 512 points (256 input points/256 output points)
Number of connected modules	Max. 128 modules (varies according to each slave module's current consumption)
Maximum transmission distance (overall length)*1	200 m*2
Transmission method	DC power superimposed total frame cyclic method
Connection style	Bus type (multi-drop method, T-branch method, tree branch method)
Transmission protocol	Dedicated protocol (AnyWireASLINK)
Error control	Checksum, double verification method
Transmission clock	27.0 kHz
RAS function	Transmission cable break position detection function, transmission cable short-circuit detection function, transmission power drop detection function
Transmission cable (DP, DN)	<ul style="list-style-type: none"> • UL compatible universal 2-wire cable (VCTF, VCT 1.25 mm², 0.75 mm², rated temperature 70°C or more) • UL compatible universal cable (1.25 mm², 0.75 mm², rated temperature 70°C or more) • Dedicated flat cable (1.25 mm², 0.75 mm², rated temperature 90°C)
Power cable (24 V, 0 V)*1	<ul style="list-style-type: none"> • UL compatible universal 2-wire cable (VCTF, VCT 0.75 mm²...2.0 mm², rated temperature 70°C or more) • UL compatible universal cable (0.75 mm²...2.0 mm², rated temperature 70°C or more) • Dedicated flat cable (1.25 mm², 0.75 mm², rated temperature 90°C)
Transmission cable supply current*1	Using 1.25 mm ² cable: Max. 2 A Using 0.75 mm ² cable: Max. 1 A
External power supply	Voltage: 21.6...27.6 V DC (24 V DC -10...+15%), ripple voltage 0.5 Vp-p or less Recommended voltage: 26.4 V DC (24 V DC +10%) Module current consumption: 0.1 A Transmission cable current supply: Max. 2 A*1

*1: Refer to the manual for the relation of the overall length, transmission cable (DP, DN) wire diameter and transmission cable current supply. In some slave modules with cables, the wire diameter of the transmission cable (DP, DN) integrated with the module may be 0.75 mm² or less.

*2: With the slave module having an integrated transmission cable (DP, DN) and module, the length of the transmission cable (DP, DN) is included in the overall length.



MELSOFT integrated FA software increases productivity by combining tools for development, maintenance, and operation of Q Series systems



Automation has brought tremendous productivity benefits to industrial and commercial applications. By creating the MELSOFT integrated FA software family of products, Mitsubishi Electric is aiming to bring similar productivity benefits to system designers, automation engineers, operators, and maintenance personnel. MELSOFT engineering tools are undergoing continuous evolution in order to meet the demands of new technologies and applications.

Programmable Controller Engineering Software

GX Works2

GX Works2

GX Works2 focuses on driving down total cost by including features that speed up commissioning, reduce downtime, improve programming productivity, and provide strong security.



For further details, please refer to the "MELSOFT GX Works2" catalog.

L(NA)08122E

● User interface that is "easy to use" by design

The programming tool GX Works2 has been developed from the ground up to be intuitive for all users and allow anyone to begin programming easily. The user interface and other functions provide a comfortable programming environment that enables improvements in design efficiency.

Fully integrated intelligent function module management tools
 Use tabs to easily switch between programs, parameters, and other screens
 Improve readability by hiding ladder rungs not relevant to the current operation
 Use "Watch windows" to conveniently monitor pertinent values

Project tree gives compressive look at flow of information in program and structure
 Program titles help to identify the content of each program
 Cross reference devices and labels with ease
 Use the Inline-ST*1 feature to quickly write complex expressions in ladder programs

*1 In-line ST can be only be created in projects that use labels.

● **Easily create circuits with few key inputs**

The program can be easily modified using the keyboard shortcut [Alt] + [←] / [→] or [Alt] + [↑] / [↓] keys.

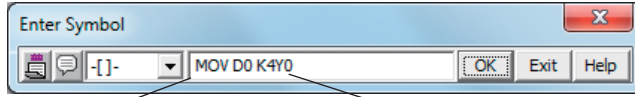

■ Editing the circuit
 [Alt] + [→] ... MOV → D0 → K4Y0
 [Alt] + [←] ... K4Y0 → D0 → MOV



■ Changing the device No.
 [Alt] + [↑] ... K4Y0 → K4Y1 → K4Y2
 [Alt] + [↓] ... K4Y2 → K4Y1 → K4Y0

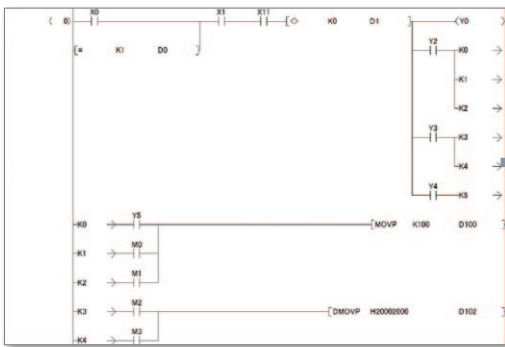

Easy-to-read display

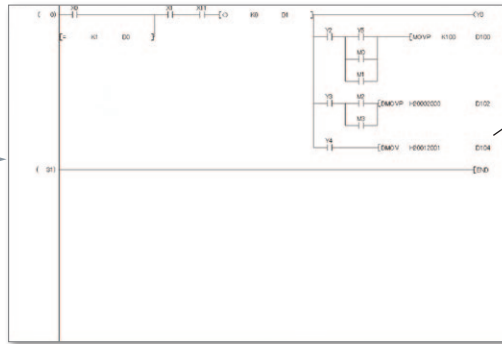

The number of contacts on one line can be changed to 9, 11, 13, 17 or 21 contacts.

The circuit line doesn't wrap, easier to read.

Click the Undo button.

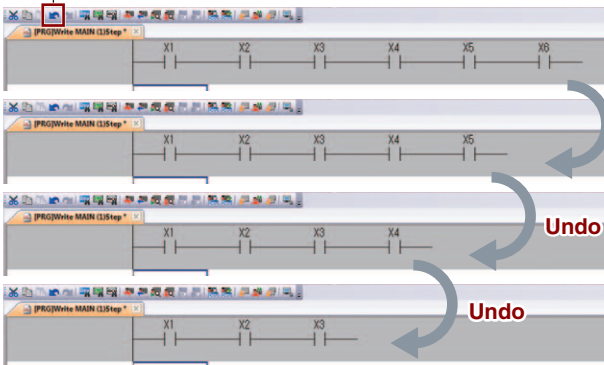

Undo

Use Undo ([Ctrl] + [z]) to go back to up to 30 previous input steps.



The device number is automatically incremented when repeatedly pasting a cut/copied ladder rung.

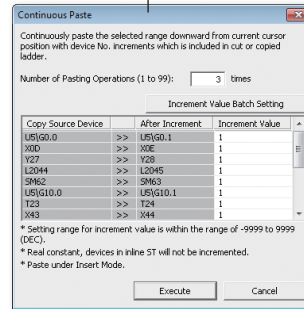

● **Efficiently edit lines with keyboard**

Ladder rungs can be easily modified just by using the various keyboard shortcut keys, eliminating the need to switch to editing mode.

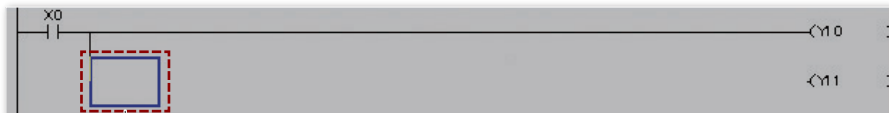

Input line with [Ctrl] + [→] or [Ctrl] + [↓]

Input lines up to coil in batch with [Ctrl] + [Shift] + [→]

(Batch input lines in a vertical direction with [Ctrl] + [Shift] + [↓])

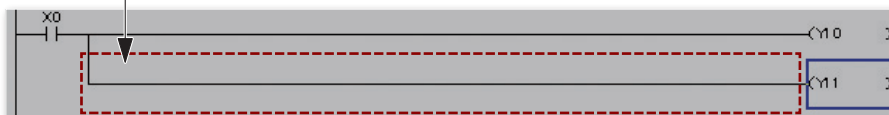

■ How to input a line
 Press [Ctrl] + [→] or [Ctrl] + [↓] at an empty spot.
 Press [Ctrl] + [→] or [Ctrl] + [↓] on top of a line to delete it.

● Use function blocks for common operations

Function blocks allow selections of commonly used code to be easily reused and shared among projects. Shared or created function blocks can be added to a program using simple drag and drop operation. Using function blocks effectively results in faster development times with fewer programming mistakes.

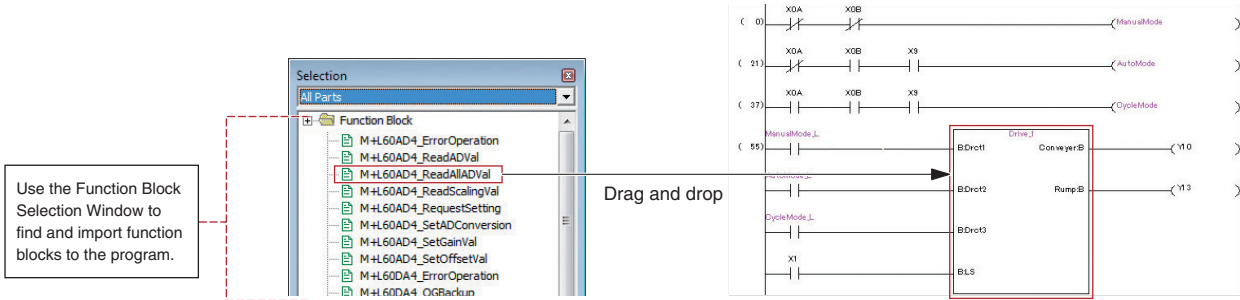

● Use sample comments to eliminate the need to input comments

Sample comments are provided for the CPU's special relays/registers and the intelligent function module's buffer memory/XY signals. These can be copied into the project's comments thus greatly reducing the time required for entering device comments.

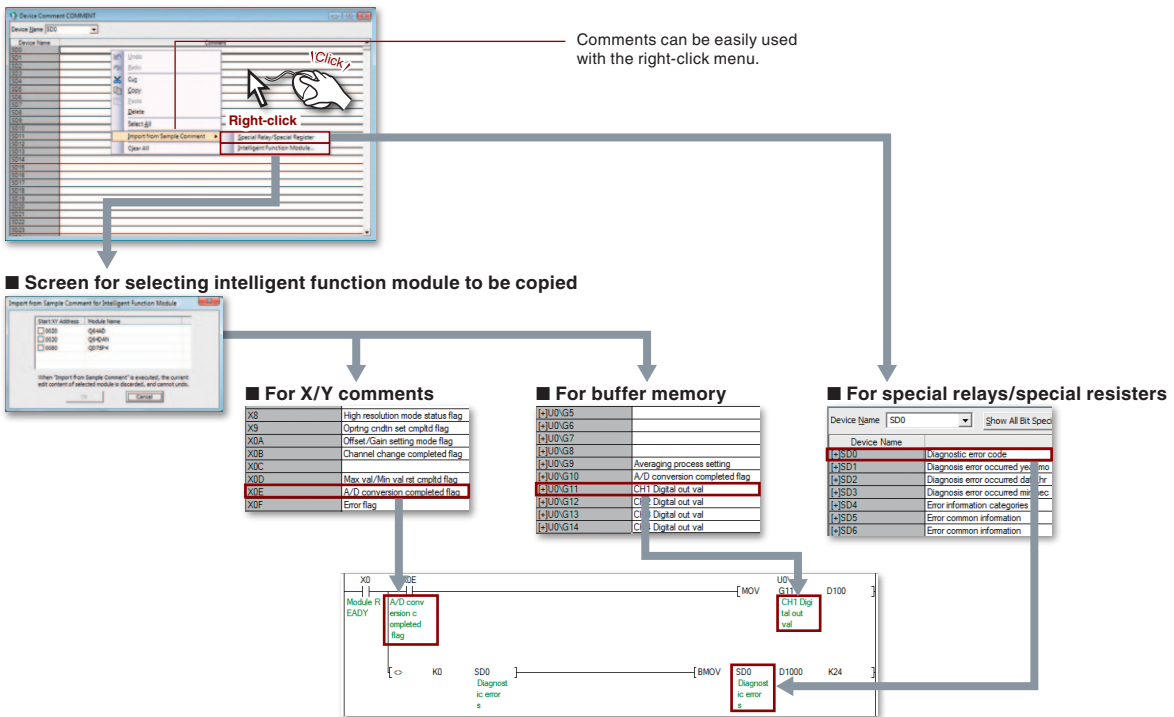

● Quickly identify similar devices

Word device comments can be registered per bit with the contents displayed directly on the ladder rung.





● **Cross referencing interlinked with circuit displays**

Relevant devices and labels can be searched within the contents of the program by using the cross reference tool. The results are immediately displayed in the cross reference dialog box conveniently besides the actual program view screen. It is then very easy to check where the relevant device is actually used within the program, just by double clicking on the target device.

The cross reference information for the device at the cursor location is automatically displayed.

Set multiple reference destinations to search.

Double-click

Click Click

Jump to the step using this device/label.

Reference Tree for Find In

Select Find In:

- [Entire project]
- Program Setting
 - Initial Program
 - Initial
 - Scan Program
 - Cycle
 - Auto
 - Standby Program
 - Fixed Scan Program
 - No Execution Type
 - COUNTUP
 - Cycle_ST
 - LDsample
 - MAIN

● **Offline debug without physical hardware**



The simulation function is now integrated. The program can be executed in a step-by-step method, finding program errors more easily.

Debugging features can be accessed using the toolbar.

Break Execution

It's easy to begin debugging

Set breakpoints and confirm them in the docking window

Debug programs using only a PC, no connection to the actual hardware is necessary.

Break Point

Enable/Disable	Comparative Source (Device/Label)	Condition	Comparative Target (Value/Device/Label)	Jump	Enable/Disable	Data Name	Position (*)	Program Content	Break On
<input checked="" type="checkbox"/>	D0	<		<input checked="" type="checkbox"/>			9	AND Relay(D)	Always
<input checked="" type="checkbox"/>	MAIN/Relay00	Rang	<	<input checked="" type="checkbox"/>			15	LD= WordData0 WordData1	Always
<input checked="" type="checkbox"/>	MAIN/Result	<		<input checked="" type="checkbox"/>			75	RET	Always

Break Point

Jump: Break Point Skip Range

Lab/CP-U-B1 Simulation (L87/7/Step) Insert

GX Simulator2

Tool Options

Switch: RESET STOP RUN

LED: MODE RUN ERR USER

GX Configurator
Function

● **Integrating the intelligent function module setting tool (GX Configurator)**

The intelligent function module's setting functions have been unified with GX Works2. Manage the intelligent function module's setting with a GX Works2 project.

■ **New module addition screen**

Settings are also applied on the I/O assignment parameters.

Module is added to the project tree.

Click! Click!

Set the A/D conversion system.

Explanations on setting items appear as guidance

● **System monitor and PLC diagnostics displayed visually**

Operation status of the entire control system is clearly displayed. The monitor screen shows each module's diagnosis and detailed information, allowing errors to be identified quickly.

Base Module	Base Model Name	Power	Start	Stop	Installed
Q020-Q64AD	Q020-Q64AD	OK	12	4	4

■ **System error history**
Simplify troubleshooting with a combined, time-stamped, error history list for CPUs and intelligent function modules. The details section provides explanations of error codes and suggested solutions.

Module Name: Q040H
I/O Address: 0000
Main Base: 3504

■ **Detailed module information**
Resolve intelligent function module issues quickly by clicking on a module to open this function. All of the information relevant to the module is displayed here including error codes, their description, and possible solutions.

Module Name	Operation	Start	Stop	Time	Error Info
Q020-Q64AD	OK	2008-10-08	2008-10-08	20:00:00	

■ **PLC diagnostics**
From one central window quickly read error and status information, export log files to CSV, perform remote CPU operations like reset, stop, CPU memory format, and more.



● **Time-stamped error history list**

Simplify troubleshooting with a combined, time-stamped, error history list for the CPU and all expansion modules. The details section provides explanations of error codes and suggested solutions.

No.	Error Code	Date and Time	Model Name	Start I/O
00050	8782	2009/10/08 18:14:17	QJ61BT11N	0110
00059	7D13	2009/10/08 17:53:06	QJ71C24N-R2	00F0
00058	7D16	2009/10/08 17:52:32	QJ71C24N-R2	00F0
00057	05DC	2009/10/08 16:14:09	Q26UDEHCPU	----
00056	7D12	2009/10/08 16:00:53	QJ71C24N-R2	00F0
00055	7D16	2009/10/08 15:56:40	QJ71C24N-R2	00F0
00054	7D16	2009/10/08 15:50:24	QJ71C24N-R2	00F0
00053	7D16	2009/10/08 14:59:03	QJ71C24N-R2	00F0
00052	7D12	2009/10/08 14:43:27	QJ71C24N-R2	00F0
00051	7D12	2009/10/08 14:35:53	QJ71C24N-R2	00F0
00050	7FF2	2009/10/08 14:35:02	QJ71C24N-R2	00F0
00049	1005	2009/10/08 14:03:44	Q26UDEHCPU	----
00048	7F42	2009/10/08 13:37:00	QJ71C24N-R2	00F0
00047	0C21	2009/10/08 13:13:56	Q26UDEHCPU	----
00046	0B34	2009/10/08 13:12:40	Q26UDEHCPU	----
00045	05DC	2009/10/08 13:11:51	Q26UDEHCPU	----
00044	7F42	2009/10/08 12:04:52	QJ71C24N-R2	00F0
00043	0840	2009/10/08 11:43:17	Q26UDEHCPU	----
00042	0840	2009/10/08 11:43:17	Q26UDEHCPU	----

Explanation

Station number specification error. The transmission destination and source stations were the same when other station connection was specified.

Solution

Check the transmission destination station number, or change to host connection.

Quickly identify the error, its cause, and solution without the need to reference a manual.

● **Save, edit labels and parameters with Microsoft® Excel®**

Various program data can be exported in CSV file format.

Exporting to CSV format has various advantages, as shown below:

- Data can be utilized on a personal computer even if GX Works2 is not installed
- Data can be saved directly on the personal computer
- Data can be sent and utilized off-site
- Utilization of data for creating documents and graphs are possible using Excel®
- Can use in other software that support CSV format

■ **Example of I/O assignment setting CSV file**

I/O assignment setting

No.	Slot	Type	Model Name	Points	Start XY
0	PLC	Intelligent	Q64AD	16Points	0000
1	(0-0)	Intelligent	Q64AD	16Points	0010
2	(0-1)	Intelligent	Q64AD	16Points	0020
3	(0-2)	Intelligent	Q64AD	16Points	0030
4	(0-3)	Intelligent	Q64AN	16Points	0040
5	(0-4)	Intelligent	Q67SP4	16Points	0040
6					
7					

Base Model Name	Power Model Name	Extension Cable	Slots
Man Q312B	Q61P		5
Ext-Base1			
Ext-Base2			
Ext-Base3			
Ext-Base4			
Ext-Base5			
Ext-Base6			
Ext-Base7			

- » Ladder program Write/Read
- » Label setting Write/Read
- » Parameter (I/O assignment setting, X/Y assignment confirmation) ... Write
- » Verification results Write
- » Sampling trace function Read (CSV file format that can be read with GX LogViewer)
- » Watch window device/label list Write/Read
- » System monitor diagnostics, product information, PLC diagnostics, module error history Write
- » Device memory Write/Read

CSV file

	A	B	C	D	E	F	G	H	I	J	K	L	M	N	O
4	0(0-0)	Intelligent	16	0	Q64AD	Clear	Stop	----	34616	----	598	----	----	----	Base Model Name
5	1(0-1)	Intelligent	16	16	Q64AD	Clear	Stop	----	52	----	----	----	----	----	Q312B
6	2(0-2)	Intelligent	16	32	Q64AD	Clear	Stop	----	----	----	----	----	----	----	Power Model Name
7	3(0-3)	Intelligent	16	48	Q64DAN	Clear	Stop	----	----	----	----	----	----	----	Q61P
8	4(0-4)	Intelligent	16	64	QD75P4	Clear	Stop	----	----	----	----	----	----	----	Extension Cable
9															
10															
11															Slots
12															5

I/O assignment

Advanced setting

Switch setting

Basic setting

iQ Works

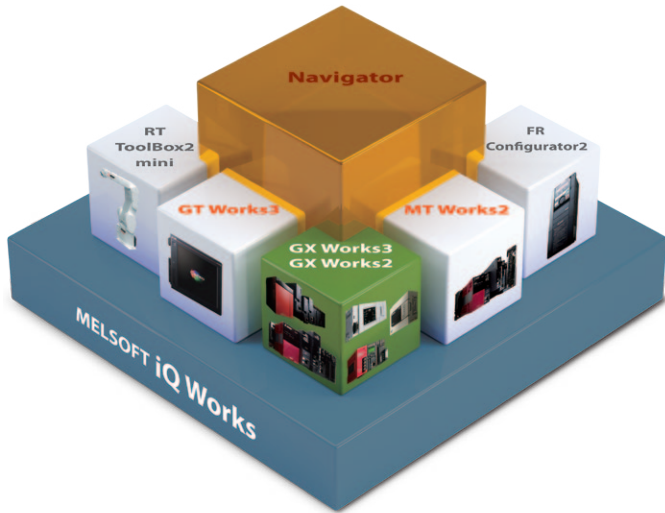

MELSOFT iQ Works

Next Generation Integrated Engineering Environment

iQ Works is the combination of (GX Works3, GX Works2, MT Works2, GT Works3, RT ToolBox2 mini, FR Configurator2) engineering software that allows for the sharing of design information to improve programming efficiency and reduce TCO.

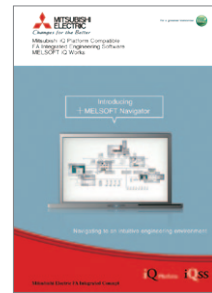

For further details, please refer to the "MELSOFT iQ Works" catalog.

L(NA)08232ENG

● Graphical project management

The entire control system is represented using the "Network Configuration" and "Module Configuration" windows. System components are easily added using a drag & drop interface and the validity of the system can be confirmed using the check function to ensure parameters are configured correctly, the power supply is sufficient, etc. Different project types can be grouped together (for example by factory, line, and cell) for central management.

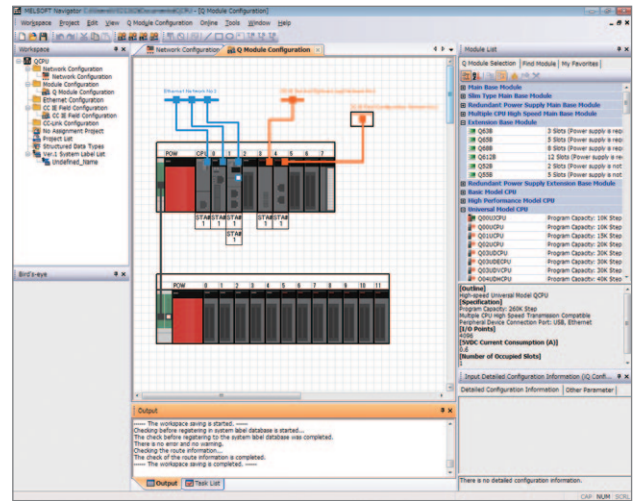

● Read project data for multiple devices in a batch

Multiple projects can be read as a block just by having one connection to the programmable controller. If there are multiple devices such as other CPU or GOT (HMI) on the same network as the target master programmable controller, it is possible to upload all projects to each target device without having to individually connect to each device.

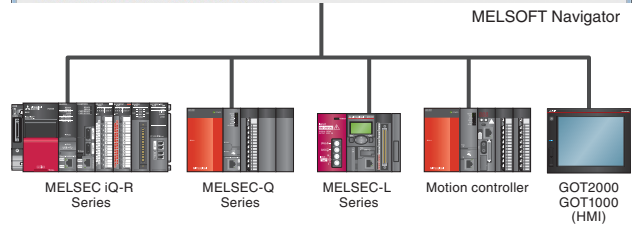
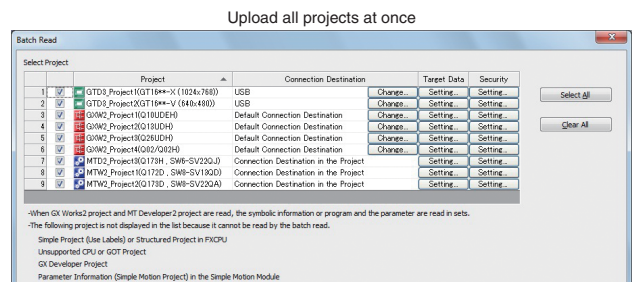



● **Automatically start up the relevant maintenance software with a single click**

Just click on the corresponding project in the system configuration diagram or workspace tree to automatically startup the software relevant for that device. Maintenance can be efficiently performed without having to know and startup each relevant software manually.

Click on corresponding project in workspace tree

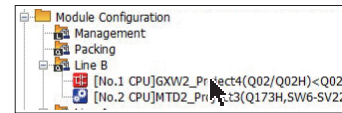

Click on corresponding device in system configuration diagram



Software for corresponding device automatically starts up

- GX Works3
- GX Works2
- MT Works2
- GT Works3
- RT ToolBox2 mini

● **Setup CC-Link slave stations**

There's no need to prepare a dedicated tool to check or change the parameter settings for the CC-Link slave station on-site. The latest version of iQ Works includes CC-Link slave station setting utility. Therefore, it is possible to directly confirm the inverter parameters or change the settings for changing the speed directly from the CC-Link configuration window, for example. In addition, error information can also be read easily.

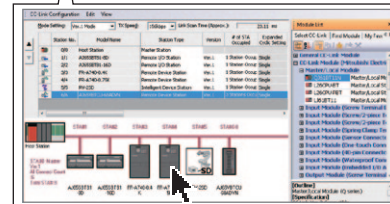

Right-click the slave station illustration and select the "slave station parameter process"

Directly open slave station's setting screen from CC-Link configuration window.

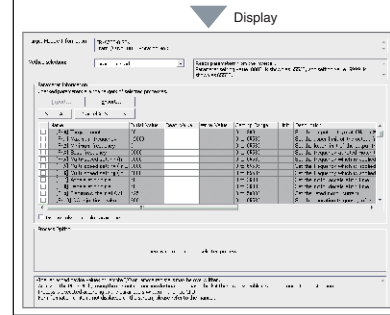

Slave station's parameter setting window opens

Set slave station parameters with GX Works2 and Navigator.

Get error information!

● **Prepare a device from the system configuration diagram with no manual inputs**

A list of modules used can be exported as a CSV file from the system configuration diagram. This is particularly useful when utilizing data for creating a bill of materials (BOM) in Excel®, etc.

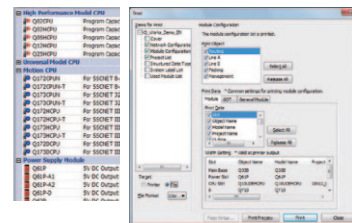

Export CSV file from list of modules

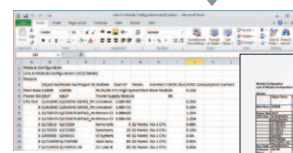

Create device list with Excel®

Print list of devices

GX LogViewer

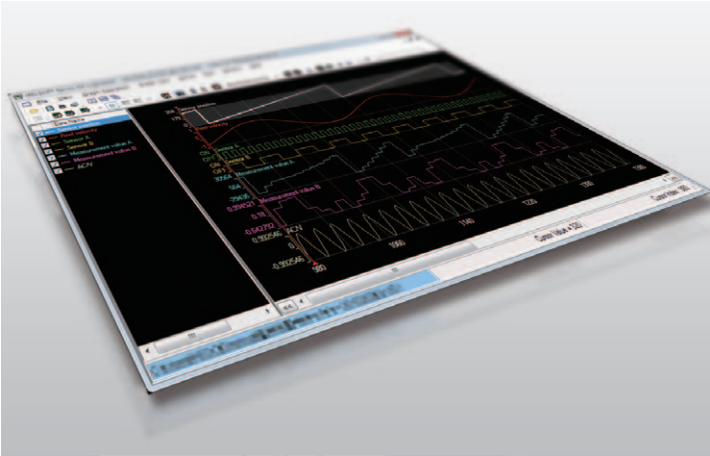

GX LogViewer

Visualizing the production process

Within modern manufacturing needs, data collection has become more important for fully optimizing the production process. GX LogViewer is a software tool that realizes visualization of large amounts of production data in a simple to use format. Utilizing this functionality to identify root error causes and improving the production rate.

● Easily display and analyze large amounts of collected logging data

This tool is used when large amounts of data need to be visualized and collected from the MELSEC-Q Series or MELSEC-L Series. The connection settings and checking of log files are the same as GX Works2 enabling individual connections to each module.

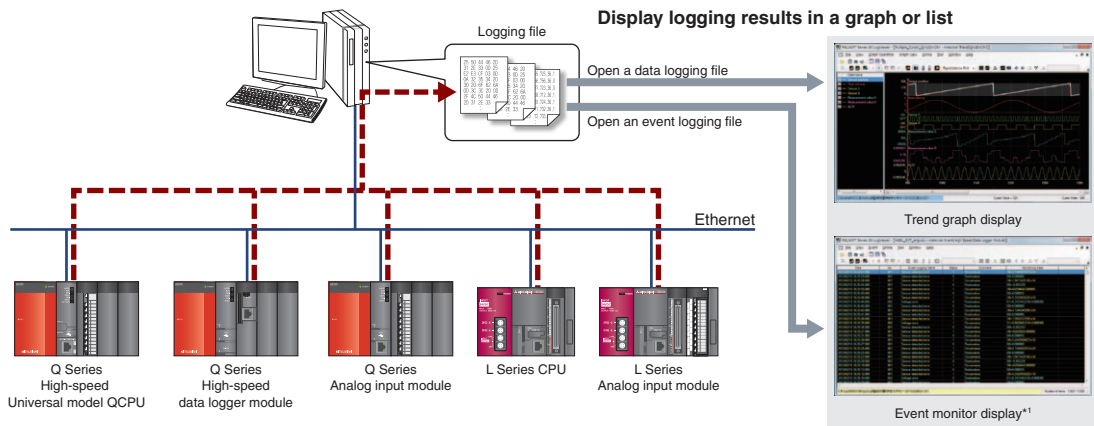

*1: The event monitor display is supported only with the Q Series high-speed logger module.

● Easily adjust graphs without referring to the setup manual

Arranging graphs

Able to arrange each graph so as not to overlap each other. It is easier to display the graphs as each graph is evenly spaced out.

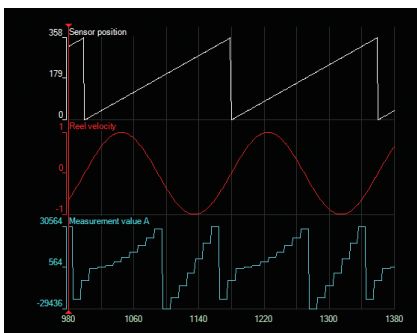

Overlapping graphs

With this it is possible to overlap each graph over one another. Multiple graphs can be compared enabling easier data analysis and comparison.

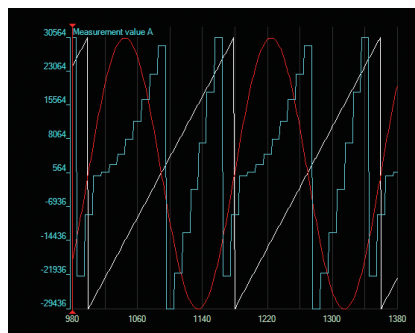

Automatically adjusting graphs

Various attributes of the graph are automatically adjusted (max/min values) as to display the upper and lower limit values better.

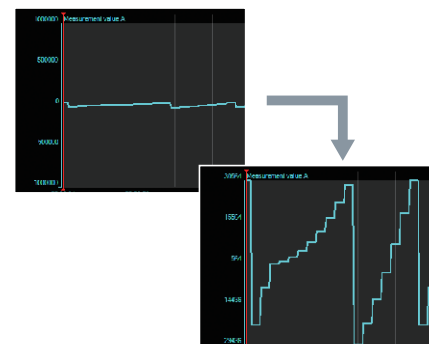



● **Easily confirm changes in data with dual cursors**

Data changes within a designated time frame can be quickly checked with user-friendly dual cursors (multi-cursors). When the cursors are moved to the point at which changes are to be confirmed, the difference in time and value between those points will appear.

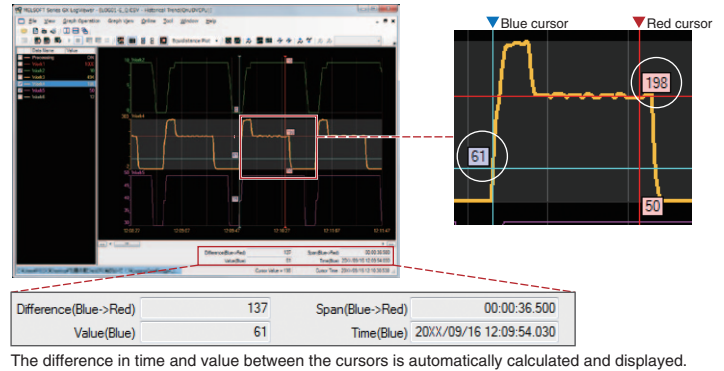

● **Display data for multiple files within one graph area for easy comparison**

Data for multiple files are displayed with the same time units in the same graph area. The display position within a file can be moved easily. This allows the differences of data within multiple files to be confirmed easily.

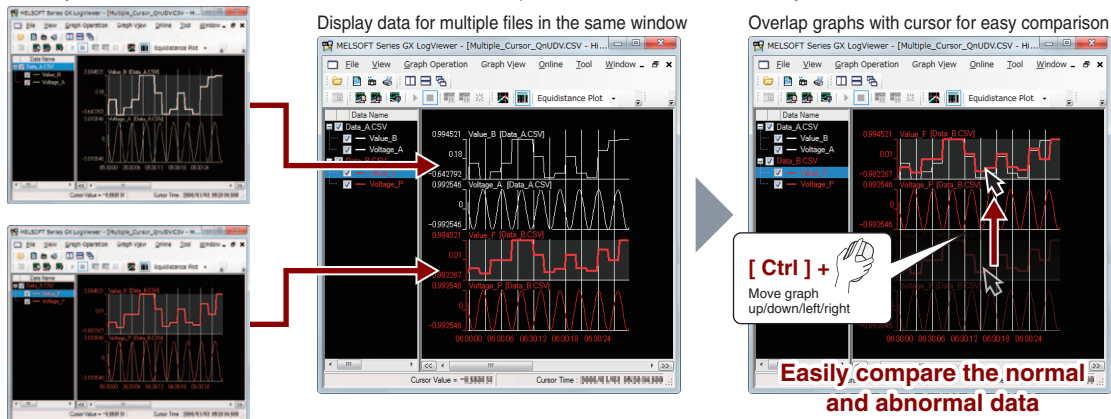

● **Quickly jump cursor to designated position**

Cursor jump
Confirm data values by quickly moving the cursor to a designated value, time or index position in the trend graph.



Jump Cursor

Select conditions for jump cursor:

Value | Time | Index

File Name: HSDL1_Q.csv

Data Name: Data5

Classification: Conditional

Search the selecting data in specified condition.

Value Range: 0 to 4294967295

Select a cursor that jumps

Red Cursor Blue Cursor

Jump Previous Jump Next Close

Value search
Values are searched, and the cursor jumps to the position where the conditions match.

Jump Cursor

Select conditions for jump cursor:

Value | Time | Index

File Name: HSDL1_Q.csv

Time Range: 2011/03/31 11:46:43 to 2011/03/31 11:48:22

Date and time to which the cursor jumps

Date

2011/03/31

Hour Minute Second

11 47 33

Select a cursor that jumps

Red Cursor Blue Cursor

Jump Previous Jump Next Close

Time designation
The cursor jumps to the designated time.

Jump Cursor

Select conditions for jump cursor:

Value | Time | Index

File Name: HSDL1_Q.csv

Index Range: 1 to 100

Index to which the cursor jumps: 51

Select a cursor that jumps

Red Cursor Blue Cursor

Jump Previous Jump Next Close

Index designation
The cursor jumps to the designated index.



MELSEC Safety

The concept of safety is shifting from "zero accidents" to "zero risk"

The safety concept has shifted from human intervention based "zero accidents" to risk assessment based "zero risk". To meet the accompanying needs of this shift, Mitsubishi Electric has introduced MELSEC Safety programmable controller to realize safety control compatible with established MELSEC programmable controller. MELSEC Safety provides a comprehensive safety control solution.

For further details, please refer to the "Safety Programmable Controller/ Safety Controller/Safety Relay Module MELSEC Safety" catalog.



L(NA)08192E



MELSEC Safety realizes visualization of safety information, realizing optimal safety control, and boosting productivity. The safety components such as Safety programmable controller, Safety controller, and Safety relay module provide a total safety solution.

Safety Programmable Controller MELSEC-QS Series

● Safety CPU*1 QS001CPU

The safety programmable controller is a programmable controller dedicated to safety control, conforming to international standards such as ISO13849-1 PLe and IEC 61508 SIL3. When connected with a safety device, such as an emergency stop switch or light curtain, this programmable controller executes safety control by turning the safety output OFF with a user-created sequence program to stop movement toward a source of hazard, such as a robot.

Machine control of the robot and conveyor, etc., is executed with a standard programmable controller in the conventional manner. The difference between the safety programmable controller and general-purpose programmable controller lies in that if the safety programmable controller itself fails, it performs a self-diagnosis to detect the failure and turn the safety output OFF forcibly. This CPU branches topology using the CC-Link Safety and CC-Link IE Field Network with safety communication function. This is ideal for large control systems requiring many safety I/O points.

*1: The CPU cannot be installed on the Q Series base unit.

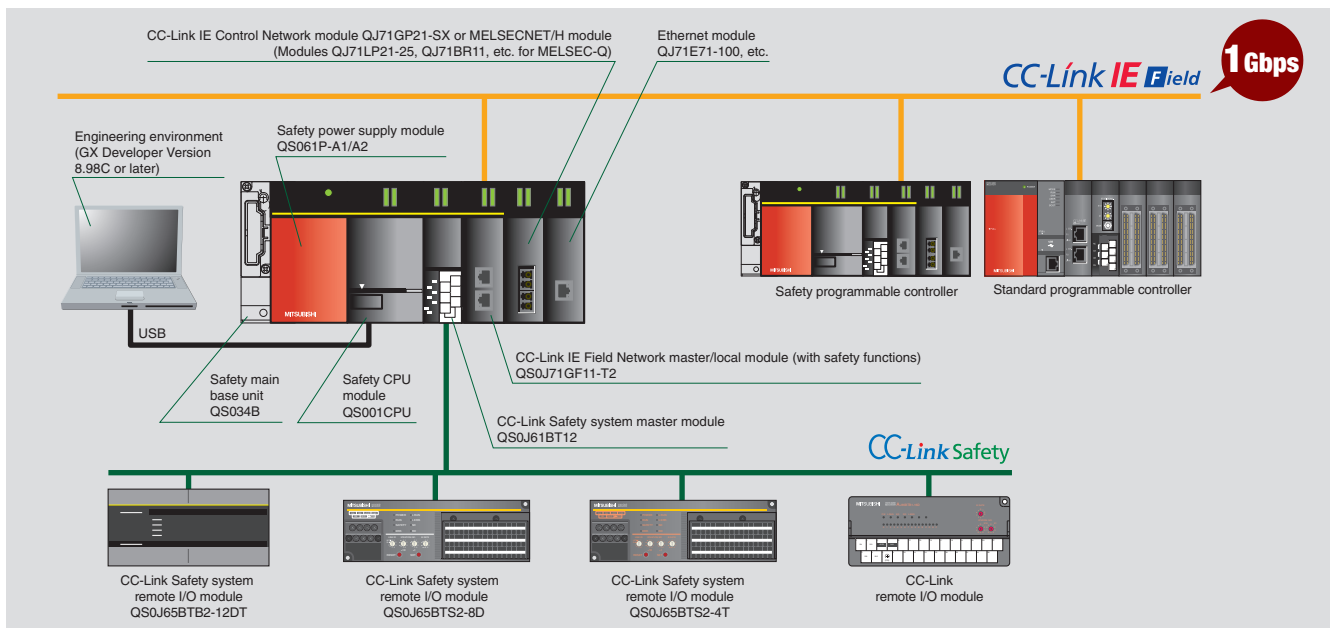

MELSEC-WS Series Safety Controller

● Safety controller CPU*1 **WS0-CPU0, WS0-CPU1, WS0-CPU3**

The safety controller is a controller dedicated to safety control, conforming to international standards such as ISO13849-1 PLe and IEC 61508 SIL3. The MELSEC-WS is ideal for small to medium-size safety machines and systems. I/O points of up to 144 (no redundancy) and up to 2 network interfaces and the dedicated Setting and Monitoring Tool, which contains safety sensor/switch connections and function blocks, all support the configuration of a safety system.

*1: The CPU cannot be installed on the Q Series base unit.

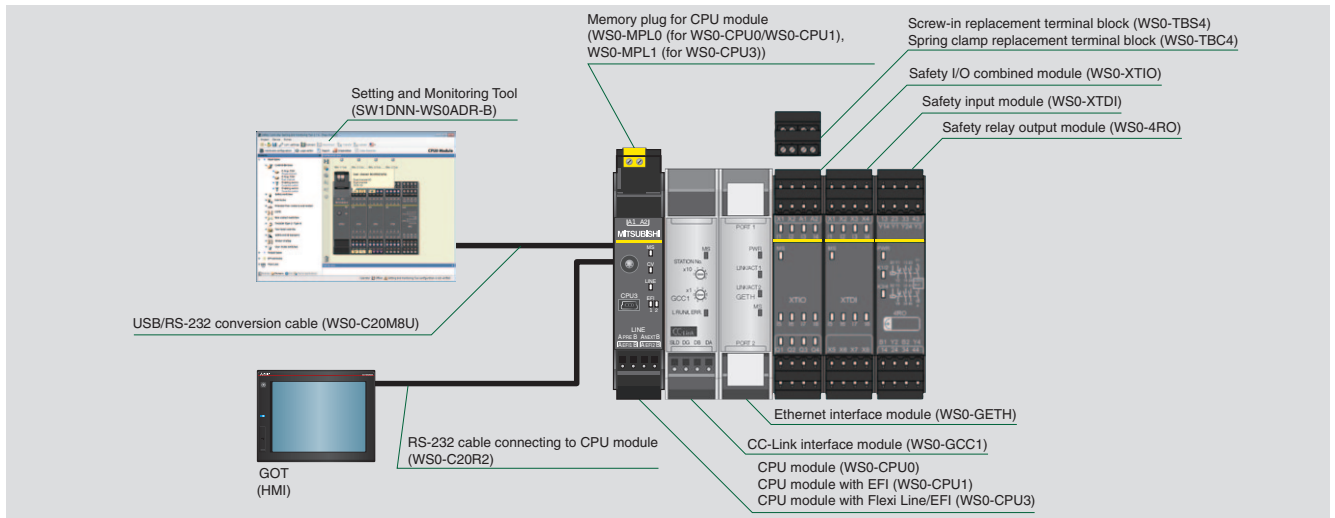

The MELSEC-WS Series is jointly developed and manufactured by Mitsubishi Electric and SICK. SICK AG, a company based in Germany, is a manufacturer of safety related products and solutions. SICK designs and manufactures a broad range of safety products including industrial-use sensors and automatic identification systems.

MELSEC-QS Series Safety Relay Modules

● Q Series safety relay module **QS90SR2SP-Q, QS90SR2SN-Q**

● CC-Link safety relay module **QS90SR2SP-CC, QS90SR2SN-CC**

● Extension safety relay module **QS90SR2SP-EX, QS90SR2SN-EX**

The safety relay module integrates the emergency stop circuit and the restart circuit with a double safety relay.

A basic safety function can be realized with just wiring, eliminating the need for programming and parameter settings.

Furthermore, the number of I/O points can be increased by adding extension modules.

■ Connecting to field network "CC-Link"

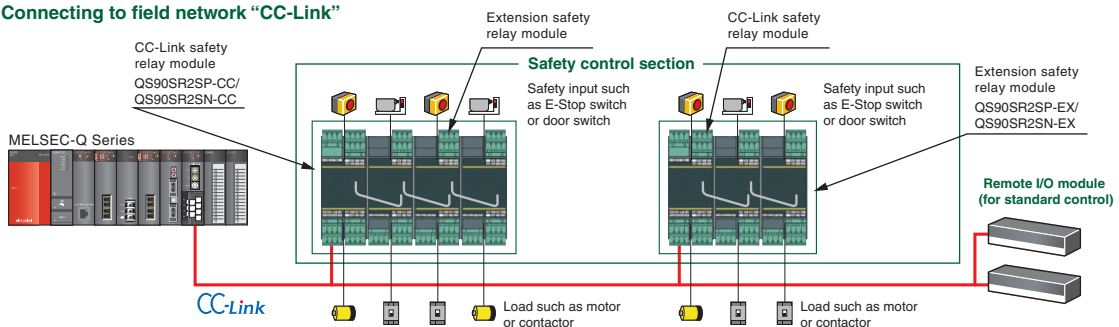

■ Installing on MELSEC-Q Series base unit

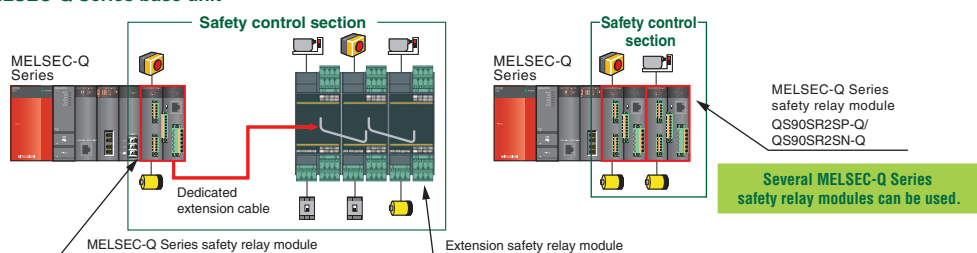



A tool for connecting! Visualizing! For a more seamless sensor control!

Sensors used on the manufacturing floor are becoming more intelligent and complex, requiring even more maintenance of equipment and the overall management of various configuration setup software. With iQSS, the intelligent sensor solution provided by Mitsubishi Electric, configuration and maintenance of sensors are further simplified with the connectivity to other components such as automation controllers, HMIs, and engineering software even further enhanced reducing the overall TCO*.

For further details, please refer to the "iQ Sensor Solution Catalog".

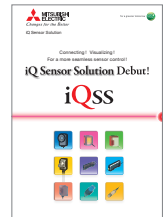

L(NA)16029ENG

iQ Sensor Solution

iQSS connects everything from general to advanced sensors.

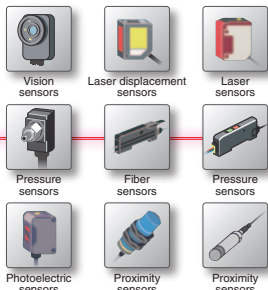

Ethernet
CC-Link IE Field
CC-Link
AnyWireASLINK

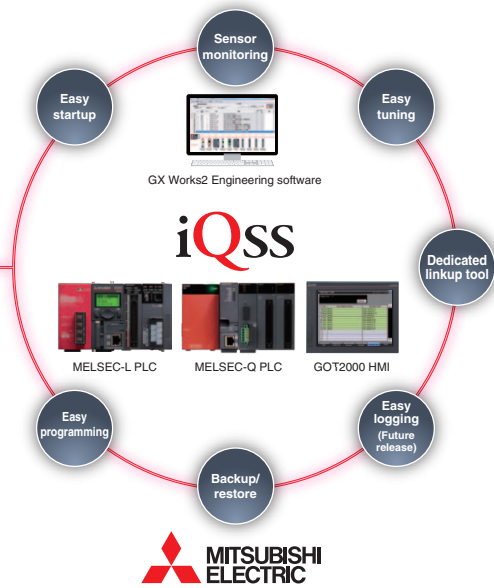

System design

To manage projects simply, we provide a workspace tree that enables projects to be managed in a single location, and a system configuration chart that depicts the entire system graphically.



System configuration management

Implementation

Functions are provided that allow monitoring from a single screen based on the system configuration chart so that the causes of problems can be identified quickly. This also shortens the time taken to adjust sections involving multiple devices.



Monitoring

Programming

The labels used by PLCs can also be used by HMIs and sensors. This takes all the bother out of label setting. GOT sample screen libraries, sample ladders and function blocks, etc. are supported.

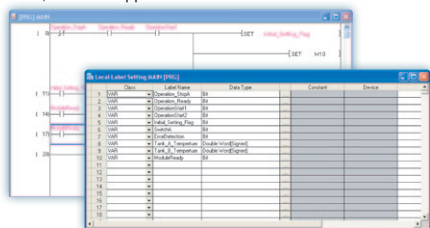

Label programming



Operation & maintenance

To make backups less laborious, batch read/write functions are provided for PLC, HMI and sensor settings.

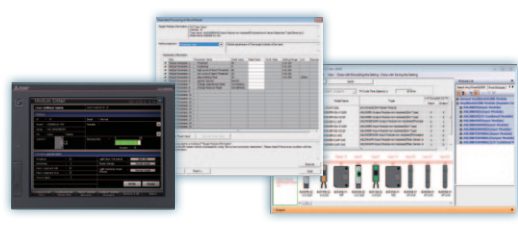

Sensor configuration read/write

Further simplifying the management of sensors in the control system



GOT2000
Graphic Operation Terminal

HMI

Combination with GOT for all scenes from startup to maintenance

The GOT2000 boasts advanced functionality, acts as a seamless gateway to other industrial automation devices, all while increasing productivity and efficiency.

The high quality display is designed to optimize operator control and monitoring of device and line statuses. If you are looking for an intuitive operation terminal, the new tablet-like operability and the higher functionality of operation terminal makes the GOT2000 the ideal choice.

Incorporate the GOT2000 to bring forth flexibility, productivity, and quality on a global scale.

For further details, please refer to the "Mitsubishi Graphic Operation Terminal GOT2000 Series Catalog".



L(NA)08270ENG

Graphic Operation Terminal

GOT2000 series/GOT1000 series

Ladder programs can easily be edited on the GOT

Sequence Program Monitor (Ladder Editor) GT27/GT25/GT16/GT15

Sequence programs can be edited in a circuit diagram (ladder format). To quickly change contacts in an emergency, sequence programs can be edited in ladder format without using a personal computer.

* Supported by XGA/SVGA/VGA models excluding the 5.7-inch type.
* Process CPUs, redundant CPUs are not supported.

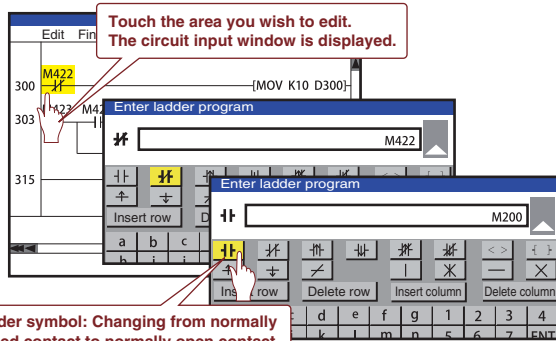

Program debugging can be performed without opening the control panel

FA Transparent All models

Connected with a PC, the GOT acts as a transparent gateway to enable programming, start up, and adjustment of equipment using GX Works2 or GX LogViewer. Users do not have to bother with opening the control panel or changing cable connections.

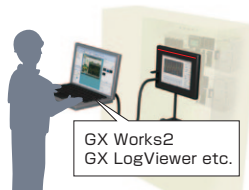

(On the GT23, GT21, or GT10 Series, the FA transparent function can be used via the interface on the rear side.)

Programmable controller can be recovered promptly in case of emergency

Backup/Restore GT27/GT25/GT23/GT21/GT16/GT15/GT14/GT12

Sequence programs and parameters can be backed up to the CF card or USB memory in the GOT.

Users can perform batch operation to restore the data to the PLC CPU or motion controller.

Make a data backup in case of a problem such as a dead battery in a PLC CPU to quickly replace the faulty device and restore the system without using a personal computer.

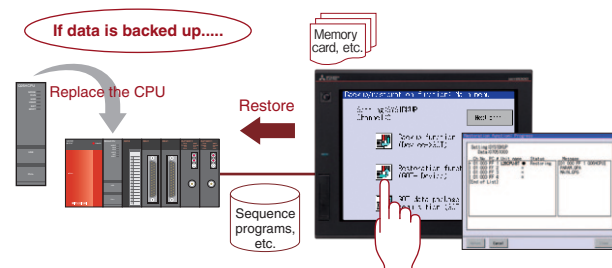

* Redundant CPUs are not supported.

View logging data without a PC

Log Viewer GT27/GT25/GT16

Logging data can be confirmed with the GOT even if a PC is not available on-site, allowing problems to be troubleshooted quickly. Changes in the data can be quickly confirmed with the dual cursors (multi-cursors) that are displayed similar to GX LogViewer.

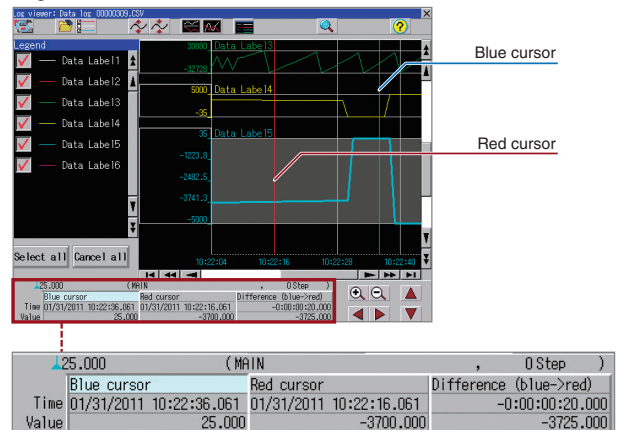

Programmable controller conditions and errors can be checked quickly

Device Monitor/System Monitor All models

Programmable controller devices can be monitored and changed without use of PC.

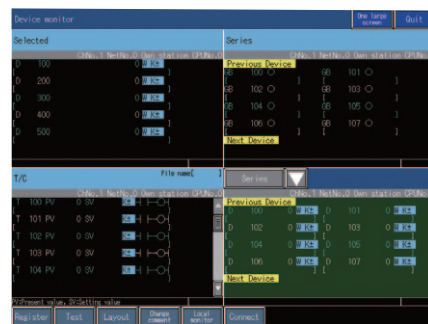

Intelligent Module Monitor GT27/GT25/GT16/GT15

Buffer memory values and I/O information can be monitored and changed. QD77GF16, QD77MS, QD73A1 are supported.

* Supported by XGA/SVGA/VGA models.

Network Monitor GT27/GT25/GT16/GT15

Enable monitoring of the network line statuses of the CC-Link IE Control Network, CC-Link IE Field Network, MELSECNET/H, and MELSECNET/10 on a dedicated screen.

Network Module Status Display GT27/GT25/GT16/GT15

Enable monitoring of LED status, error status, among others of network modules on a GOT.



AC Servo

Man, machine and environment in perfect harmony

MELSERVO-J4 — trusted technology makes an evolutionary leap forward.

Introducing the MELSERVO-J4 series. Offering more than just improved performance, these servos are designed to drive the industries of tomorrow. Backed by Mitsubishi leadership in all-digital technology, MELSERVO has become one of the most globally respected names in factory automation. And now — with the safety, ease of use, and energy-efficient design of the new MELSERVO-J4 series — man, machine and environment can at last work together in perfect harmony.



For further details, please refer to the "MELSERVO-J4" catalog.

L(NA)03058

MITSUBISHI SERVO AMPLIFIERS & MOTORS

MELSERVO-J4



Machine

- The leading edge in drive control
- Industry-leading level of basic performance
 - High-resolution absolute position encoder
 - Advanced one-touch tuning
 - Advanced vibration suppression control II
 - Robust filter

[Advanced one-touch tuning]

Servo gains including vibration suppression control and robust filter are adjusted just by turning on the one-touch tuning function. Machine performance is utilized to the fullest using the advanced vibration suppression control function.

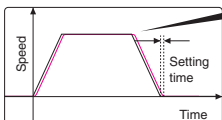

Exactly matched. High-speed positioning



Man

- Safety and convenience
- Equipped with the safety observation function (IEC/EN 61800-5-2)
 - Tough drive function
 - Large capacity drive recorder
 - Machine diagnosis function
 - MR Configurator2

[Large capacity drive recorder]

Servo data (motor current, etc.) before and after the alarm occurrence are stored in non-volatile memory. Waveforms can be checked in graph. This enables quick and accurate identification of the cause of the alarm.



The Environment

- Eco-friendly design that's winning acclaim worldwide
- Multi-axis servo amplifier
 - Power monitor function
 - Compatible with power regeneration common converter
 - Energy-conservation achieved by improved performance

[Power monitor function]

Power consumption is calculated from the data in the servo amplifier such as speed and current, and then displayed, enabling energy-conserving system examination.

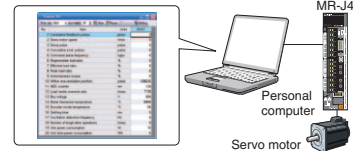

Lineup

Servo Amplifiers



- MR-J4-B**
SSCNET III/H compatible servo amplifier
- MR-J4W2-B**
SSCNET III/H compatible 2-axis servo amplifier
- MR-J4W3-B**
SSCNET III/H compatible 3-axis servo amplifier

With the SSCNET III/H compatible servo amplifier, a synchronous system can be configured using high-speed serial optical communication. Servo system performance and functions are utilized to the fullest when the servo amplifier is combined with the servo system controller.



- MR-J4-B-RJ010 + MR-J3-T10**
CC-Link IE Field Network servo amplifier with Motion

The CC-Link IE Field Network interface servo amplifier with Motion is compatible with the Motion control in the Ethernet-based open network.



- MR-J4-A**
General-purpose interface compatible servo amplifier

The general-purpose interface compatible servo amplifier enables position control by pulse train command and speed/torque control by analog voltage command.

Servo Motors

Rotary servo motor

- Small capacity, low inertia
HG-KR Series
Capacity: 50 to 750 W
- Small capacity, ultra-low inertia
HG-MR Series
Capacity: 50 to 750 W
- Medium capacity, medium inertia
HG-SR Series
Capacity: 0.5 to 7 kW

- Medium/large capacity, low inertia
HG-JR Series
Capacity: 0.5 to 55 kW
- Medium capacity, ultra-low inertia
HG-RR Series
Capacity: 1 to 5 kW
- Medium capacity, flat type
HG-UR Series
Capacity: 0.75 to 5 kW

Linear servo motor

- Core type
LM-H3 Series
Rating: 70 to 960 N
- Core type with magnetic attraction counter-force
LM-K2 Series
Rating: 120 to 2400 N
- Core type (natural/liquid cooling)
LM-F Series
Rating: 300 to 3000 N (natural cooling)
Rating: 600 to 6000 N (liquid cooling)
- Coreless type
LM-U2 Series
Rating: 50 to 800 N

Direct drive motor

- TM-RFM Series**
Rating: 2 to 240 N·m

Achieving higher drive performance and energy conservation with inverters

The inverter is a variable frequency power device that can easily and freely change the speed of a 3-phase induction motor.

The Mitsubishi inverter is high-performance and environment-conscious, and complies with global standards.

Select a model from our diverse lineup to match your needs.

Inverter



Answering various needs with the best choices Frequency Inverter

Inverter

- FR800 Series A800, F800
- FR700 Series E700, F700PJ, D700

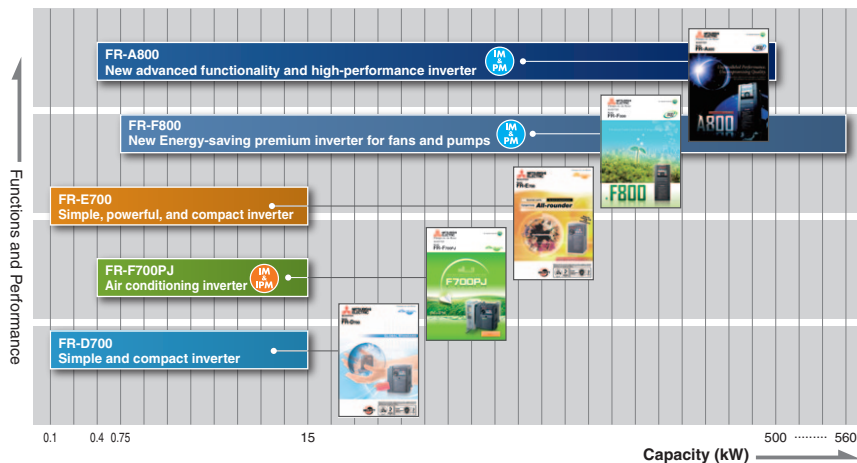

Control inverter with CC-Link communication

The inverter can be controlled to a programmable controller with CC-Link.^{*1}

This function is supported with CC-Link Ver. 1.1 and Ver. 2.0.

The inverter can be operated and monitored, and the parameters set from the programmable controller.

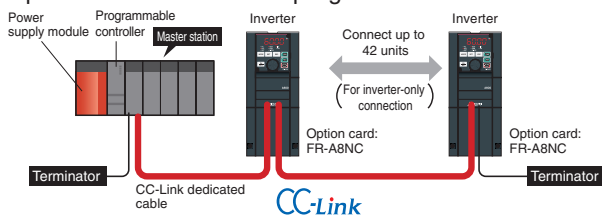

*1: The inverter option card (FR-A8NC) is required.

Please refer to the relevant catalog for additional information.

Easy synchronous operation with SSCNET III connection

Connect to a motion controller with SSCNET III^{*2}. SSCNET III uses the high-speed synchronous serial communication method (high-speed, high-accuracy, high-reliability optical communication), and is perfect for synchronous operation.

(SSCNET: Servo System Controller Network)

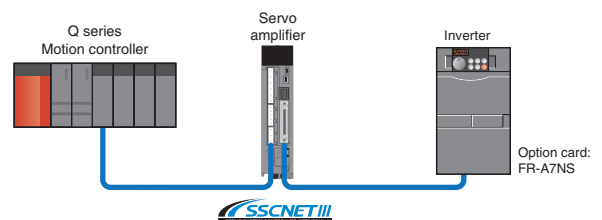

*2: The inverter option card (FR-A7NS) is required.



Contactors and Motor Starters

Diverse variations to respond to all situations

The Mitsubishi Electric Contactors and Motor Starters MS-T and MS-N series and DC interface contactor SD-Q series products are equipped with an environment and global compliance, compact size, ease-of-use and safety. Certification to various international standards, this highly reliable magnetic contactor is suitable for a variety of applications from panels to systems.

For further details, please refer to the "Magnetic Motor Starters and Contactors MS-T/N series Catalog".



L(NA)02030



L(NA)74109218

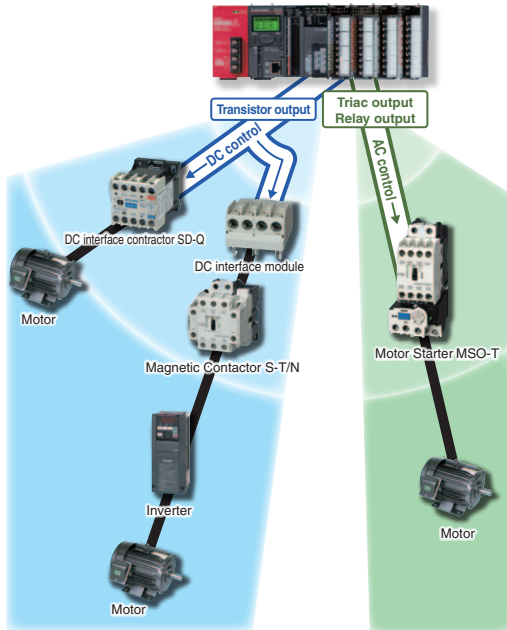

Direct drive with Programmable Controller

The SD-Q Series has a small coil VA and can be driven by the programmable controller without adding an amplifying relay. By adding the DC interface module, the MS-T/N Series can be used with a wide range of motor capacities.

		Programmable controller output module type		
		Transistor output	Contact output	Triac output
DC interface contactor SD-Q Series	DC operation	●	●	—
Magnetic contactor MS-T Series	AC operation (Using DC interface module)	●	●	●
Magnetic contactor MS-N Series	AC operation (Using DC interface module)	●	●	●
	DC operation	△	—	—

*: This table shows the relation of the programmable controller output module type and operation interface. There may be restrictions according to the type of frame size, etc., that can be used. Refer to the MS-T/N Series Catalog, or contact a Mitsubishi dealer or Sales Office for details on the types of magnetic switches and models that can be used.

SD-Q series

Direct drive is possible with the programmable controller's transistor output. Since a relay and interface module are not required, the number of parts can be reduced, and space can be saved.

Standard surge absorber

Prevent adverse effects onto the peripheral equipment.

Standard terminal cover

A terminal cover with finger protection function is installed as a standard. This cover answers to user's needs for safety.

MS-T series (10A to 32A)

Mitsubishi Electric's main series is equipped with a small size, ease-of-use, safety and international compliance. This series greatly contributes to smaller panels, easier selection and compliance with international standards.

10A frame model is just 36 mm wide!!

The industry's smallest width has been realized for the general-purpose magnetic contactor. The other rated products have also been downsized to help you reduce your panel size.

*: 10A frame general-purpose magnetic contactor (Mitsubishi Electric survey as of Oct. 2014)

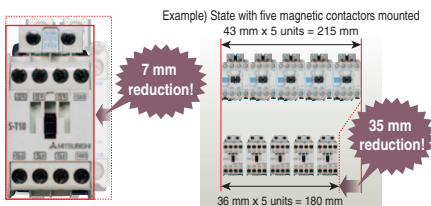

Wide range of operation coil ratings!!

The wider operation coil rating ranges allow us to consolidate the number of coil types from 14 types (N Series) to 7 types.

This helps reduce stock and makes it easier to select the required type.

Standard terminal cover!!

The standard terminal cover improves the safety in the panel, and simplifies ordering as a separate model no longer needs to be specified.



COGNEX[®] machine vision system and Mitsubishi Electric FA Devices

Innovating your production with this integral power.

Functioning as devices that “watch” instead of human eyes, COGNEX machine vision systems have continued to reform automation of production lines. Mitsubishi Electric FA devices, such as programmable controllers, lead the future of automation. The possibilities of vision system solutions, created in the integration of this spirit of innovation, have continued to increase.



L(NA)08230E
For further details, please refer to the "Vision System & Factory Automation Solution Catalog".

Vision Solution

COGNEX In-Sight EZ Series iQSS ready! Device partner

- Entry model **EZ-700**
- Standard model **EZ-720**
- High-speed processing model **EZ-740**
- High resolution model **EZ-742**

Simple connection

Directly connect with Ethernet

The “In-Sight EZ” can be directly connected to the Ethernet port provided on the “MELSEC-Q Series universal model” and “MELSEC-L” programmable controller, and to the Ethernet module on the MELSEC-F. By using a switching hub, a multi-unit vision system having units installed as far as 100 m away can be created.

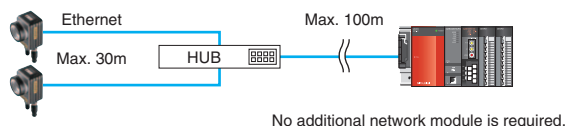

Simple communication with SLMP

Now that “In-Sight EZ” supports SLMP, data can be easily written from the vision system to the programmable controller. Communication is easily configured with “EasyBuilder”. Just select the connected device and SLMP, set the programmable controller device used for communication and select the communication data from the list. With the SLMP scanner mode, a trigger can be applied on the vision system via SLMP.

Simple control with function blocks (FB)

Intuitively setup the vision control system from the GX Works2 programming tool utilizing dedicated vision function blocks without having to develop specific programming code.

COGNEX DataMan[®] Barcode Reader Device partner

- Fixed DataMan **DataMan 50/60/300**
- Hand-held DataMan **DataMan 8050/8100/8500**

DataMan - active in various industries



● Fixed DataMan 50/60

- ▶ Unmatched read rate performance with Hotbars™
- ▶ Proprietary Hotbars™ technology
- ▶ Solid state design with no moving parts
- ▶ Easy setup with three position adjustable lens and integrated lighting aimer
- ▶ IP65-rated housing (DataMan 50)
- ▶ Supports SLMP (DataMan 60)



DataMan 50



DataMan 60

● Fixed DataMan 300 Series

- ▶ Unprecedented read rate with Hotbars™
- ▶ Reads the most difficult-to-read 2-D Direct Part Mark (DPM) codes
- ▶ Liquid lens with automatic variable focus
- ▶ Intelligent tuning
- ▶ Integrated lighting module
- ▶ Supports SLMP



DataMan 300

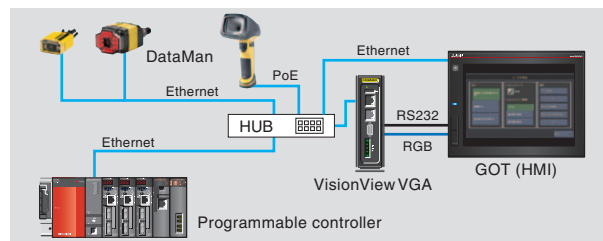

● Hand-held DataMan 8050/8100/8500 Series

- ▶ UltraLight[®]: Two types of lighting enable optimum reading*1
- ▶ Newly developed body enhances sturdiness
- ▶ Standard automatic focus adjustment function*2
- ▶ Supports SLMP
- ▶ Cordless capability (up to 30 m communication range)
- ▶ Unprecedented read rate with Hotbars™



DataMan 8500

*1: DataMan 8500

*2: DataMan 8100 and 8500



Robot

Simulating people, and then surpassing them

The Mitsubishi Electric industrial robot will revolutionize your manufacturing site with faster, more intrinsic and simpler functions.

Mitsubishi Electric aims to easily realize automated production equipment. In addition to improving the performance of the robot, we propose the "MELFA F Series" which is equipped with intelligent technology we have developed and verified at our own production facilities.

For further details, please refer to the "Mitsubishi INDUSTRIAL ROBOT MELFA F Series" catalog.



L(NA)09067ENG

The iQ Platform compatible robot controller increases the speed of data communications between CPUs and dramatically reduces I/O processing times using a high-speed standard base between multiple CPUs.

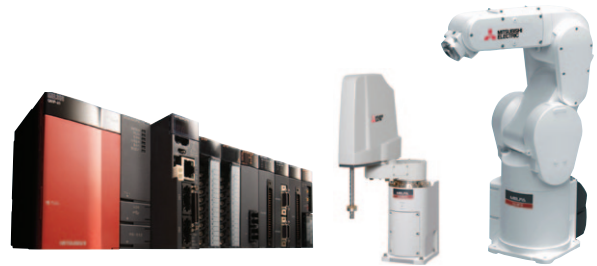

Robot

For automatic prevention of collisions between robots

- Collision avoidance

The software constantly monitors robots motion, predicts collisions before they occur, and immediately stops the robots. This avoids damage to the robot during both the JOG operations and automatic mode operations. Also, this enables the number of interlocks needed to prevent collisions between robots to be reduced. (Alarm shutdown)

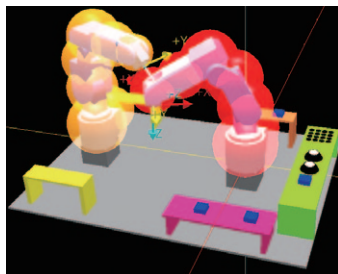
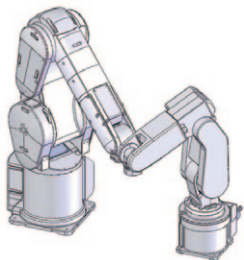

Checking interference using the robot with a defined solid model

Decreases downtime during startup operation

Reduces the number of recovery man-hours required after collisions due to teaching operation errors or failure to set interlocks.

Coordinated control between multiple robots

- Coordinated control

Enables coordinated control between multiple robots through CPU connection between the robots. Easy to operate and use under normal operation through individual robot operation.

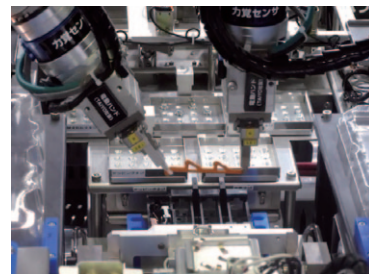

Enables installation work to be completed while gripper positions between robots are maintained.

Coordinated transport

Enables transport of lengthy or heavy objects using multiple small-sized robots instead of larger ones.

Lineup

RV-F series



RV-2F Load capacity: 2 kg Reach: 504 mm	RV-4F Load capacity: 4 kg Reach: 510 mm	RV-4FL Load capacity: 4 kg Reach: 645 mm	RV-7F Load capacity: 7 kg Reach: 716 mm	RV-7FL Load capacity: 7 kg Reach: 910 mm	RV-7FLL Load capacity: 7 kg Reach: 1503 mm	RV-13F Load capacity: 13 kg Reach: 1094 mm	RV-13FL Load capacity: 13 kg Reach: 1388 mm	RV-20F Load capacity: 20 kg Reach: 1094 mm
--	--	---	--	---	---	---	--	---

RH-F series



RH-3FH Load capacity: 3 kg Reach: 350-450-550 mm	RH-6FH Load capacity: 6 kg Reach: 350-450-550 mm	RH-12FH Load capacity: 12 kg Reach: 550-700-850 mm	RH-20FH Load capacity: 20 kg Reach: 850-1,000 mm
---	---	---	---



General Specifications

General specifications indicate the environmental specifications in which this product can be installed and operated. Unless otherwise specified, the general specifications apply to all products of the Q Series.
Install and operate the Q Series products in the environment indicated in the general specifications.

Item	Specification					
Operating ambient temperature	0...55°C					
Storage ambient temperature	-25...75°C*1					
Operating ambient humidity	5...95% RH*2, non-condensing					
Storage ambient humidity	5...95% RH*2, non-condensing					
Vibration resistance	Compliant with JIS B 3502 and IEC 61131-2	Under intermittent vibration	Frequency	Constant acceleration	Half amplitude	Sweep count
			5...8.4 Hz	–	3.5 mm (0.14 inches)	
		Under continuous vibration	8.4...150 Hz	9.8 m/s ²	–	10 times each in X, Y, Z directions
			5...8.4 Hz	–	1.75 mm (0.069 inches)	
		8.4...150 Hz	4.9 m/s ²	–	–	
Shock resistance	Compliant with JIS B 3502 and IEC 61131-2 (147 m/s ² , 3 times in each of 3 directions X, Y, Z)					
Operating atmosphere	No corrosive gases					
Operating altitude*3	≤ 2000 m (6562 feet)					
Installation location	Inside a control panel					
Overvoltage category*4	≤ II					
Pollution level*5	≤ 2					
Equipment class	Class I					

*1: The storage ambient temperature is -20 to 75°C if the system includes the AnS/A Series modules.

*2: The operating ambient humidity and storage ambient humidity are 10 to 90% RH if the system includes the AnS/A Series modules.

*3: Do not use or store the programmable controller under pressure higher than the atmospheric pressure of altitude 0 m.

Doing so can cause a malfunction.

When using the programmable controller under pressure, please contact your sales representative.

*4: This indicates the section of the power supply to which the equipment is assumed to be connected between the public electrical power distribution network and the machinery within premises.

Category II applies to equipment for which electrical power is supplied from fixed facilities. The surge voltage withstand level for up to the rated voltage of 300 V is 2500 V.

*5: This index indicates the degree to which conductive material is generated in terms of the environment in which the equipment is used.

Pollution level 2 is when only non-conductive pollution occurs. A temporary conductivity caused by condensing must be expected occasionally.

CPU Module Performance Specifications

Universal model QCPU

Item		Q03UDVCP	Q04UDVCP	Q06UDVCP	Q13UDVCP	Q26UDVCP	Q00UJCPU	Q00UCPU	Q01UCPU
Control method		Stored program cyclic operation							
I/O control mode		Refresh							
Program language (sequence control language)		<ul style="list-style-type: none"> Relay symbol language (ladder) Logic symbolic language (list) MELSAP3 (SFC), MELSAP-L Function block Structured text (ST) 							
Peripheral connection port	USB ^{*1}	●							
	Ethernet (100BASE-TX/10BASE-T)	●				—			
	RS-232	—				●			
Memory card interface		(SD Memory Card, SDHC Memory Card) ^{*2}				—			
Extended SRAM cassette port		●				—			
Processing speed ^{*3}	LD instruction	1.9 ns				120 ns	80 ns	60 ns	
	MOV instruction	3.9 ns				240 ns	160 ns	120 ns	
	PC MIX value ^{*4} (instruction/μs)	227				4.92	7.36	9.79	
	Floating point addition	0.014 μs				0.42 μs	0.30 μs	0.24 μs	
Total number of instructions ^{*5}		859				821	855		
Floating point instruction		●				●			
Character string processing instruction		●				●			
PID instruction		●				●			
Special function instruction (Trigonometric function, square root, exponential operation, etc.)		●				●			
Constant scan (Function for keeping regular scan time)		0.5...2000 ms (setting available in units of 0.1 ms)				0.5...2000 ms (setting available in units of 0.5 ms)			
Program capacity ^{*6}		30K steps	40K steps	60K steps	130K steps	260K steps	10K steps	15K steps	
Number of I/O device points [X/Y]		8192 points							
Number of I/O points [X/Y]		4096 points				256 points	1024 points		
Internal relay [M] ^{*7}		9216 points	15360 points		28672 points		8192 points		
Latch relay [L] ^{*7}		8192 points							
Link relay [B] ^{*7}		8192 points							
Timer [T] ^{*7}		2048 points							
Retentive timer [ST] ^{*7}		0 point							
Counter [C] ^{*7}		1024 points							
Data register [D] ^{*7}		13312 points	22528 points		41984 points		12288 points		
Extended data register [D] ^{*7}		0 point				—	0 point		
Link register [W]		8192 points							
Extended link register [W] ^{*7}		0 point				—	0 point		
Annunciator [F] ^{*7}		2048 points							
Edge relay [V] ^{*7}		2048 points							
Link special relay [SB] ^{*7}		2048 points							
Link special register [SW] ^{*7}		2048 points							
File register [R, ZR]		98304 points ^{*8}	131072 points ^{*8}	393216 points ^{*8}	524288 points ^{*8}	655360 points ^{*8}	—	65536 points	
Step relay [S] ^{*7}		8192 points							
Index register/standard device register [Z]		Max. 20 points							
Index register [Z] (32-bit ZR indexing)		Max. 10 points (Index register [Z] is used in double words.)				—	Max. 10 points (Index register [Z] is used in double words.)		
Pointer [P]		4096 points				512 points			
Interrupt pointer [I]		256 points				128 points			
Special relay [SM]		2048 points							
Special register [SD]		2048 points							
Function input [FX]		16 points							
Function output [FY]		16 points							
Function register [FD]		5 points							
Local device		●				—			
Device initial values		●				●			

*1: The USB port terminal is mini-B.

*2: The operation of devices that are not manufactured or recommended as compatible products by Mitsubishi Electric cannot be guaranteed.

*3: The processing speed is the same even when the device is indexed.

*4: The PC MIX value is the average number of instructions such as the basic and data processing instructions executed in 1μs. A larger value indicates a higher processing speed.

*5: Intelligent function module dedicated instructions are not included.

*6: When the QnUD(H)CPU or QnUDE(H)CPU is replaced with the QnUDVCP, the number of steps in the program may change (increase or decrease). For more information, refer to the relevant manual.

*7: Indicates the number of points in the default state. This can be changed with the parameter.

*8: Indicates the number of points when using the built-in memory (standard RAM). This can be increased with the extended SRAM cassette.

When using together with the extended SRAM cassette, the value obtained by totaling the number of points in the following table is the number of file registers that can be used.

With Q4MCA-1MBS (1 MB)	With Q4MCA-2MBS (2 MB)	With Q4MCA-4MBS (4 MB)	With Q4MCA-8MBS (8 MB)
524288 points	1048576 points	2097152 points	4194304 points

*9: Indicates the number of points when using the built-in memory (standard RAM). This can be expanded with the SRAM card or Flash card. (Writing from the program is not possible with the Flash card.) Up to 4184064 points can be used with the SRAM card.



Q02UCPU	Q03UDECPU Q03UDCPU	Q04UDEHCPU Q04UDHCPU	Q06UDEHCPU Q06UDHCPU	Q10UDEHCPU Q10UDHCPU	Q13UDEHCPU Q13UDHCPU	Q20UDEHCPU Q20UDHCPU	Q26UDEHCPU Q26UDHCPU	Q50UDEHCPU	Q100UDEHCPU	
Stored program cyclic operation										
Refresh										
<ul style="list-style-type: none"> • Relay symbol language (ladder) • Logic symbolic language (list) • MELSAP3 (SFC), MELSAP-L • Function block • Structured text (ST) 										
●										
—	Q03UDECPU	Q04UDEHCPU	Q06UDEHCPU	Q10UDEHCPU	Q13UDEHCPU	Q20UDEHCPU	Q26UDEHCPU	●		
●	Q03UDCPU	Q04UDHCPU	Q06UDHCPU	Q10UDHCPU	Q13UDHCPU	Q20UDHCPU	Q26UDHCPU	—		
●										
(SRAM card, Flash card, ATA card)										
—										
40 ns	20 ns	9.5 ns								
80 ns	40 ns	19 ns								
14	28	60								
0.18 μs	0.12 μs	0.057 μs								
857	Q03...Q26UDE(H)CPU: 865							Q03...26UD(H)CPU: 855		865
●										
●										
●										
●										
●										
0.5...2000 ms										
(setting available in units of 0.5 ms)										
20K steps	30K steps	40K steps	60K steps	100K steps	130K steps	200K steps	260K steps	500K steps	1000K steps	
8192 points										
2048 points	4096 points									
8192 points										
8192 points										
8192 points										
2048 points										
0 point										
1024 points										
12288 points										
0 point								131072 points		
8192 points										
0 point										
2048 points										
2048 points										
2048 points										
2048 points										
65536 points* ⁹	98304 points* ⁹	131072 points* ⁹	393216 points* ⁹	524288 points* ⁹		655360 points* ⁹		786432 points* ⁹	917504 points* ⁹	
8192 points										
Max. 20 points										
Max. 10 points										
(Index register [Z] is used in double words.)										
4096 points								8192 points		
256 points										
2048 points										
2048 points										
16 points										
16 points										
5 points										
●										
●										

CPU Module Performance Specifications

Basic model QCPU

Item		Q00JCPU	Q00CPU	Q01CPU
Control method		Stored program cyclic operation		
I/O control mode		Refresh		
Program language (sequence control language)		<ul style="list-style-type: none"> • Relay symbol language (ladder) • Logic symbolic language (list) • MELSP3 (SFC), MELSP-L • Function block • Structured text (ST) 		
Peripheral connection port	USB	—		
	RS-232	●		
Memory card interface		—		
Processing speed*1	LD instruction	200 ns	160 ns	100 ns
	MOV instruction	700 ns	560 ns	350 ns
	PC MIX value (instruction/μs)*2	1.6	2.0	2.7
	Floating point addition	65.5 μs	60.5 μs	49.5 μs
Total number of instructions*3		534	564	
Floating point instruction		●		
Character string processing instruction		●*4		
PID instruction		●		
Special function instruction (Trigonometric function, square root, exponential operation, etc.)		●		
Constant scan (Function for keeping regular scan time)		1...2000 ms (setting available in units of 1 ms)		
Program capacity		8K steps		14K steps
Number of I/O device points [X/Y]		2048 points		
Number of I/O points [X/Y]		256 points	1024 points	
Internal relay [M]*5		8192 points		
Latch relay [L]*5		2048 points		
Link relay [B]*5		2048 points		
Timer [T]*5		512 points		
Retentive timer [ST]*5		0 point		
Counter [C]*5		512 points		
Data register [D]*5		11136 points		
Link register [W]*5		2048 points		
Annunciator [F]*5		1024 points		
Edge relay [V]*5		1024 points		
Link special relay [SB]		1024 points		
Link special register [SW]		1024 points		
File register [R, ZR]		—	65536 points	
Step relay [S]		2048 points		
Index register [Z]		10 points		
Pointer [P]		300 points		
Interrupt pointer [I]		128 points		
Special relay [SM]		1024 points		
Special register [SD]		1024 points		
Function input [FX]		16 points		
Function output [FY]		16 points		
Function register [FD]		5 points		
Local device		—		
Device initial values		●		

*1: The processing speed is the same even when the device is indexed.

*2: The PC MIX value is the average number of instructions such as the basic and data processing instructions executed in 1 μs. A larger value indicates a higher processing speed.

*3: Intelligent function module dedicated instructions are not included.

*4: Character strings can be used only when using the character string transfer instruction (\$MOV).

*5: Indicates the number of points in the default state. This can be changed with the parameter.



High Performance QCPU

Item		Q02CPU	Q02HCPU	Q06HCPU	Q12HCPU	Q25HCPU
Control method		Stored program cyclic operation				
I/O control mode		Refresh				
Program language (sequence control language)		<ul style="list-style-type: none"> • Relay symbol language (ladder) • Logic symbolic language (list) • MELSAP3 (SFC), MELSAP-L • Function block • Structured text (ST) 				
Peripheral connection port	USB	—		●		
	RS-232			●		
Memory card interface		● (SRAM card, Flash card, ATA card)				
Processing speed*1	LD instruction	79 ns		34 ns		
	MOV instruction	237 ns		102 ns		
	PC MIX value (instruction/μs)*2	4.4		10.3		
	Floating point addition	1.8 μs		0.78 μs		
Total number of instructions*3		725				
Floating point instruction		●				
Character string processing instruction		●				
PID instruction		●				
Special function instruction (Trigonometric function, square root, exponential operation, etc.)		●				
Constant scan (Function for keeping regular scan time)		0.5...2000 ms (setting available in units of 0.5 ms)				
Program capacity		28K steps		60K steps	124K steps	252K steps
Number of I/O device points [X/Y]		8192 points				
Number of I/O points [X/Y]		4096 points				
Internal relay [M]*4		8192 points				
Latch relay [L]*4		8192 points				
Link relay [B]*4		8192 points				
Timer [T]*4		2048 points				
Retentive timer [ST]*4		0 point				
Counter [C]*4		1024 points				
Data register [D]*4		12288 points				
Link register [W]*4		8192 points				
Annunciator [F]*4		2048 points				
Edge relay [V]*4		2048 points				
Link special relay [SB]		2048 points				
Link special register [SW]		2048 points				
File register [R, ZR]		32768 points*5	65536 points*5		131072 points*5	
Step relay [S]		8192 points				
Index register [Z]		16 points				
Pointer [P]		4096 points				
Interrupt pointer [I]		256 points				
Special relay [SM]		2048 points				
Special register [SD]		2048 points				
Function input [FX]		16 points				
Function output [FY]		16 points				
Function register [FD]		5 points				
Local device		●				
Device initial values		●				

*1: The processing speed is the same even when the device is indexed.

*2: The PC MIX value is the average number of instructions such as the basic and data processing instructions executed in 1 μs. A larger value indicates a higher processing speed.

*3: Intelligent function module dedicated instructions are not included.

*4: Indicates the number of points in the default state. This can be changed with the parameter.

*5: Indicates the number of points when the built-in memory (standard RAM) is used. Capacity can be expanded by using an SRAM card or a Flash card. (Writing from a program is not possible with a Flash card.) With an SRAM card, up to 1041408 points can be used.

CPU Module Performance Specifications

Process CPU

Item		Q02PHCPU	Q06PHCPU	Q12PHCPU	Q25PHCPU
Control method		Stored program cyclic operation			
I/O control mode		Refresh			
Program language	Sequence control language	<ul style="list-style-type: none"> Relay symbol language (ladder) Logic symbolic language (list) MELSAP3 (SFC), MELSAP-L Function block Structured text (ST) 			
	Process control language	<ul style="list-style-type: none"> Process control FBD*1 			
Peripheral connection port	USB	●			
	RS-232	●			
Memory card interface		● (SRAM card, Flash card, ATA card)			
Processing speed*2	LD instruction	34 ns			
	MOV instruction	102 ns			
	PC MIX value (instruction/μs)*3	10.3			
	Floating point addition	0.78 μs			
Total number of instructions*4		757			
Floating point instruction		●			
Character string processing instruction		●			
PID instruction		—			
Process control instruction		●			
Special function instruction (Trigonometric function, square root, exponential operation, etc.)		●			
Constant scan (Function for keeping regular scan time)		0.5...2000 ms (setting available in units of 0.5 ms)			
Program capacity		28K steps	60K steps	124K steps	252K steps
Number of I/O device points [X/Y]		8192 points			
Number of I/O points [X/Y]		4096 points			
Internal relay [M]*5		8192 points			
Latch relay [L]*5		8192 points			
Link relay [B]*5		8192 points			
Timer [T]*5		2048 points			
Retentive timer [ST]*5		0 point			
Counter [C]*5		1024 points			
Data register [D]*5		12288 points			
Link register [W]*5		8192 points			
Annunciator [F]*5		2048 points			
Edge relay [V]*5		2048 points			
Link special relay [SB]		2048 points			
Link special register [SW]		2048 points			
File register [R, ZR]		65536 points*6		131072 points*6	
Step relay [S]		8192 points			
Index register [Z]		16 points			
Pointer [P]		4096 points			
Interrupt pointer [I]		256 points			
Special relay [SM]		2048 points			
Special register [SD]		2048 points			
Function input [FX]		16 points			
Function output [FY]		16 points			
Function register [FD]		5 points			
Local device		●			
Device initial values		●			

*1: PX Developer is required for programming by FBD.

*2: The processing speed is the same even when the device is indexed.

*3: The PC MIX value is the average number of instructions such as the basic and data processing instructions executed in 1 μs. A larger value indicates a higher processing speed.

*4: Intelligent function module dedicated instructions are not included.

*5: Indicates the number of points in the default state. This can be changed with the parameter.

*6: Indicates the number of points when the built-in memory (standard RAM) is used. Capacity can be expanded by using an SRAM card or a Flash card. (Writing from a program is not possible with a Flash card.)
With an SRAM card, up to 1041408 points can be used.



Redundant CPU

Item		Q12PRHCPU	Q25PRHCPU
Control method			Stored program cyclic operation
I/O control mode			Refresh
Program language	Sequence control language		<ul style="list-style-type: none"> Relay symbol language (ladder) Logic symbolic language (list) MELSAP3 (SFC), MELSAP-L Function block Structured text (ST)
	Process control language		<ul style="list-style-type: none"> Process control FBD*1
Peripheral connection port	USB		●
	RS-232		●
Memory card interface			● (SRAM card, Flash card, ATA card)
Processing speed*2	LD instruction		34 ns
	MOV instruction		102 ns
	PC MIX value (instruction/μs)*3		10.3
	Floating point addition		0.78 μs
Total number of instructions*4			778
Floating point instruction			●
Character string processing instruction			●
PID instruction			●
Process control instruction			●
Special function instruction (Trigonometric function, square root, exponential operation, etc.)			●
Constant scan (Function for keeping regular scan time)			0.5...2000 ms (setting available in units of 0.5 ms)
Program capacity		124K steps	252K steps
Number of I/O device points [X/Y]			8192 points
Number of I/O points [X/Y]			4096 points
Internal relay [M]*5			8192 points
Latch relay [L]*5			8192 points
Link relay [B]*5			8192 points
Timer [T]*5			2048 points
Retentive timer [ST]*5			0 point
Counter [C]*5			1024 points
Data register [D]*5			12288 points
Link register [W]*5			8192 points
Annunciator [F]*5			2048 points
Edge relay [V]*5			2048 points
Link special relay [SB]			2048 points
Link special register [SW]			2048 points
File register [R, ZR]			131072 points*6
Step relay [S]			8192 points
Index register [Z]			16 points
Pointer [P]			4096 points
Interrupt pointer [I]			256 points
Special relay [SM]			2048 points
Special register [SD]			2048 points
Function input [FX]			16 points
Function output [FY]			16 points
Function register [FD]			5 points
Local device			●
Device initial values			●

*1: PX Developer is required for programming by FBD.

*2: The processing speed is the same even when the device is indexed.

*3: The PC MIX value is the average number of instructions such as the basic and data processing instructions executed in 1 μs. A larger value indicates a higher processing speed.

*4: Intelligent function module dedicated instructions are not included.

*5: Indicates the number of points in the default state. This can be changed with the parameter.

*6: Indicates the number of points when the built-in memory (standard RAM) is used. Capacity can be expanded by using an SRAM card or a Flash card. (Writing from a program is not possible with a Flash card.) With an SRAM card, up to 1041408 points can be used.

Module Combinations for Multiple CPU System

Restrictions apply depending on CPU type, the number that can be installed, and supported serial No. For more information, please refer to the relevant users manual for each CPU.

Multiple CPU high speed main base unit (Q3□DB)

- Possible
- Possible (multiple CPU high-speed communication not available)
- Impossible

CPU 1 \ CPU 2 to 4		High-speed Universal model QCPU	Universal model QCPU		High Performance model QCPU	Process CPU	Motion CPU/ Robot CPU ¹ /CNC CPU		C Controller CPU	
		Q03UDV Q04UDV Q06UDV Q13UDV Q26UDV	Q00U Q01U Q02U	Q03UD(E) Q04UD(E)H Q06UD(E)H Q10UD(E)H Q13UD(E)H Q20UD(E)H Q26UD(E)H Q50UDEH Q100UDEH	Q02(H) Q06H Q12H Q25H	Q02PH Q06PH Q12PH Q25PH	Q172D Q173D Q172DS Q173DS CR750-Q CR751-Q Q173NC	Q172H Q173H Q172 Q173	Q24DHCCPU-V Q24DHCCPU-VG Q24DHCCPU-LS Q12DCCPU-V	Q06CCPU-V
High-speed Universal model QCPU	Q03UDV Q04UDV Q06UDV Q13UDV Q26UDV	●	–	●	○	○	●	–	●	–
Universal model QCPU	Q00U Q01U Q02U	–	–	–	–	–	–	–	○	○
	Q03UD(E) Q04UD(E)H Q06UD(E)H Q10UD(E)H Q13UD(E)H Q20UD(E)H Q26UD(E)H Q50UDEH Q100UDEH	●	–	●	○	○	●	–	●	○
High Performance model QCPU	Q02(H) Q06H Q12H Q25H	○	–	○	○	○	–	–	○	○

*1: The robot CPU includes CR750-Q, CR751-Q.

Main base unit other than Q3□DB

- Possible (multiple CPU high-speed communication not available)
- Impossible

CPU 1 \ CPU 2 to 4		High-speed Universal model QCPU	Universal model QCPU		High Performance model QCPU	Process CPU	Motion CPU/ Robot CPU ² /CNC CPU		C Controller CPU	
		Q03UDV Q04UDV Q06UDV Q13UDV Q26UDV	Q00U Q01U Q02U	Q03UD(E) Q04UD(E)H Q06UD(E)H Q10UD(E)H Q13UD(E)H Q20UD(E)H Q26UD(E)H Q50UDEH Q100UDEH	Q02(H) Q06H Q12H Q25H	Q02PH Q06PH Q12PH Q25PH	Q172D Q173D Q172DS Q173DS CR750-Q CR751-Q Q173NC	Q172H Q173H Q172 Q173	Q24DHCCPU-V Q24DHCCPU-VG Q24DHCCPU-LS Q12DCCPU-V	Q06CCPU-V
High-speed Universal model QCPU	Q03UDV Q04UDV Q06UDV Q13UDV Q26UDV	○	–	○	○	○*3	–	–	○*5	–
Universal model QCPU	Q00U Q01U Q02U	–	–	–	–	–	–	○*3*4	○*5	○*5
	Q03UD(E) Q04UD(E)H Q06UD(E)H Q10UD(E)H Q13UD(E)H Q20UD(E)H Q26UD(E)H Q50UDEH Q100UDEH	○	–	○	○	○*3	–	–	○*5	○*5
High Performance model QCPU	Q02(H) Q06H Q12H Q25H	○	–	○	○	○*3	–	○*3*6	○*5	○*5

*2: The robot CPU includes CR750-Q, CR751-Q.

*3: The slim type main base unit (Q3□SB) cannot be used.

*4: Can only use 1x Motion CPU.

*5: In case of using Q06CCPU-V or Q12DCCPU-V, the redundant power main base unit (Q3□RB) cannot be used.

*6: Cannot be used together with Q03UD(E), Q04UD(E)H, Q06UD(E)H, Q10UD(E)H, Q13UD(E)H, Q20UD(E)H, Q26UD(E)H, Q50UDEH, Q100UDEH, Q03UDV, Q04UDV, Q06UDV, Q13UDV, Q26UDV or Q12DCCPU-V.



Extensive global support coverage providing expert help whenever needed

Global FA centers

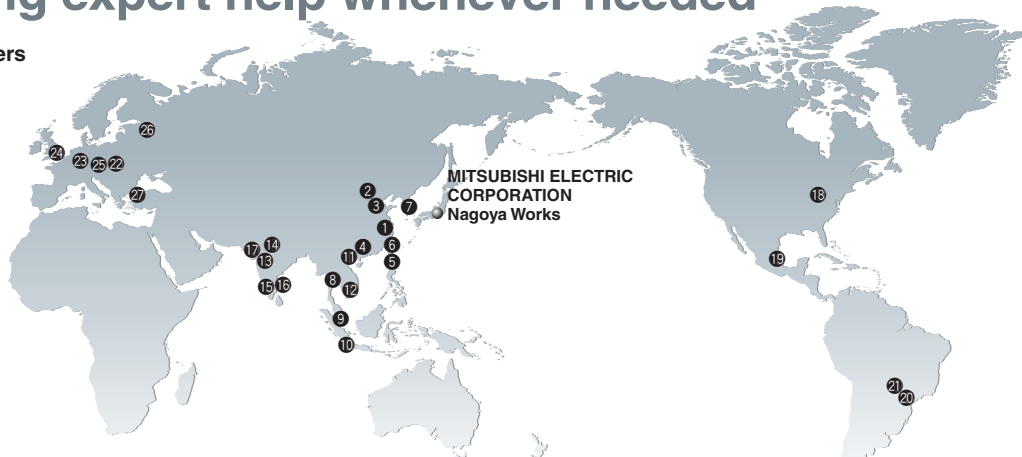

China

1 Shanghai FA Center

MITSUBISHI ELECTRIC AUTOMATION (CHINA) LTD.
No.1386 Hongqiao Road, Mitsubishi Electric Automation Center, Shanghai, China
Tel: +86-21-2322-3030 / Fax: +86-21-2322-3000

2 Beijing FA Center

MITSUBISHI ELECTRIC AUTOMATION (CHINA) LTD. Beijing Branch
Unit 901, 9F, Office Tower 1, Henderson Centre, 18 Jianguomennei Avenue, Dongcheng District, Beijing, China
Tel: +86-10-6518-8830 / Fax: +86-10-6518-2938

3 Tianjin FA Center

MITSUBISHI ELECTRIC AUTOMATION (CHINA) LTD. Tianjin Branch
Room 2003 City Tower, No.35, Youyi Road, Hexi District, Tianjin, China
Tel: +86-22-2813-1015 / Fax: +86-22-2813-1017

4 Guangzhou FA Center

MITSUBISHI ELECTRIC AUTOMATION (CHINA) LTD. Guangzhou Branch
Room 1609, North Tower, The Hub Center, No.1068, Xingang East Road, Haizhu District, Guangzhou, China
Tel: +86-20-8923-6730 / Fax: +86-20-8923-6715

Taiwan

5 Taichung FA Center

MITSUBISHI ELECTRIC TAIWAN CO.,LTD.
No.8-1, Industrial 16th Road, Taichung Industrial Park, Taichung City 40768, Taiwan, R.O.C.
Tel: +886-4-2359-0688 / Fax: +886-4-2359-0689

6 Taipei FA Center

SETSUYO ENTERPRISE CO., LTD.
3F, No.105, Wugong 3rd Road, Wugu District, New Taipei City 24889, Taiwan, R.O.C.
Tel: +886-2-2299-9917 / Fax: +886-2-2299-9963

Korea

7 Korea FA Center

MITSUBISHI ELECTRIC AUTOMATION KOREA CO., LTD.
7F-9F, Gangseo Hangang Xi-tower A, 401, Yangcheon-ro, Gangseo-Gu, Seoul 157-801, Korea
Tel: +82-2-3660-9605 / Fax: +82-2-3663-0475

Thailand

8 Thailand FA Center

MITSUBISHI ELECTRIC FACTORY AUTOMATION (THAILAND) CO., LTD.
12th Floor, SV.City Building, Office Tower 1, No. 896/19 and 20 Rama 3 Road, Kwaeng Bangpongpan, Khet Yannawa, Bangkok 10120, Thailand
Tel: +66-2682-6522 / Fax: +66-2682-6020

ASEAN

9 ASEAN FA Center

MITSUBISHI ELECTRIC ASIA PTE. LTD.
307, Alexandra Road, Mitsubishi Electric Building, Singapore 159943
Tel: +65-6470-2480 / Fax: +65-6476-7439

Indonesia

10 Indonesia FA Center

PT. MITSUBISHI ELECTRIC INDONESIA Cikarang Office
Jl. Kenari Raya Blok G2-07A Delta Silicon 5, Lippo Cikarang-Bekasi 17550, Indonesia
Tel: +62-21-2961-7797 / Fax: +62-21-2961-7794

Vietnam

11 Hanoi FA Center

MITSUBISHI ELECTRIC VIETNAM COMPANY LIMITED Hanoi Branch
6-Floor, Detch Tower, 8 Ton That Thuyet Street, My Dinh 2 Ward, Nam Tu Liem District, Hanoi, Vietnam
Tel: +84-4-3937-8075 / Fax: +84-4-3937-8076

12 Ho Chi Minh FA Center

MITSUBISHI ELECTRIC VIETNAM COMPANY LIMITED
Unit 01-04, 10th Floor, Vincom Center, 72 Le Thanh Ton Street, District 1, Ho Chi Minh City, Vietnam
Tel: +84-8-3910-5945 / Fax: +84-8-3910-5947

India

13 India Pune FA Center

MITSUBISHI ELECTRIC INDIA PVT. LTD. Pune Branch
Emerald House, EL-3, J Block, M.I.D.C Bhosari, Pune-411026, Maharashtra, India
Tel: +91-20-2710-2000 / Fax: +91-20-2710-2100

14 India Gurgaon FA Center

MITSUBISHI ELECTRIC INDIA PVT. LTD. Gurgaon Head Office
2nd Floor, Tower A & B, Cyber Greens, DLF Cyber City, DLF Phase-III, Gurgaon-122002 Haryana, India
Tel: +91-124-463-0300 / Fax: +91-124-463-0399

15 India Bangalore FA Center

MITSUBISHI ELECTRIC INDIA PVT. LTD. Bangalore Branch
Prestige Emerald, 6th Floor, Municipal No. 2, Madras Bank Road (Lavelle Road), Bangalore-560001, Karnataka, India
Tel: +91-80-4020-1600 / Fax: +91-80-4020-1699

16 India Chennai FA Center

MITSUBISHI ELECTRIC INDIA PVT. LTD. Chennai Branch
"Citilights Corporate Centre" No.1, Vivekananda Road, Srinivasa Nagar, Chetpet, Chennai-600031, Tamil Nadu, India
Tel: +91-44-4554-8772 / Fax: +91-44-4554-8773

17 India Ahmedabad FA Center

MITSUBISHI ELECTRIC INDIA PVT. LTD. Ahmedabad Branch
B/4, 3rd Floor, Safal Profitaire, Corporate Road, Prahaladnagar, Satellite, Ahmedabad, Gujarat-380015, India
Tel: +91-79-6512-0063

America

18 North America FA Center

MITSUBISHI ELECTRIC AUTOMATION, INC.
500 Corporate Woods Parkway, Vernon Hills, IL 60061, U.S.A.
Tel: +1-847-478-2469 / Fax: +1-847-478-2253

Mexico

19 Mexico FA Center

MITSUBISHI ELECTRIC AUTOMATION, INC. Mexico Branch
Mariano Escobedo #69, Col. Zona Industrial, Tlalnepanitla Edo, C.P.54030, Mexico
Tel: +52-55-3067-7511

Brazil

20 Brazil FA Center

MITSUBISHI ELECTRIC DO BRASIL COMÉRCIO E SERVIÇOS LTDA.
Rua Jussara, 1750-Bloco B Anexo, Jardim Santa Cecilia, CEP 06465-070, Barueri-SP, Brasil
Tel: +55-11-4689-3000 / Fax: +55-11-4689-3016

21 Brazil Boituva FA Center

MELCO CNC DO BRASIL COMÉRCIO E SERVIÇOS S.A.
Acesso Jose Sartorelli, KM 2.1 CEP 18550-000 Boituva-SP, Brasil
Tel: +55-15-3363-9900 / Fax: +55-15-3363-9911

Europe

22 Europe FA Center

MITSUBISHI ELECTRIC EUROPE B.V. Polish Branch
ul. Krakowska 50, 32-083 Balice, Poland
Tel: +48-12-630-47-00 / Fax: +48-12-630-47-01

23 Germany FA Center

MITSUBISHI ELECTRIC EUROPE B.V. German Branch
Gothaer Strasse 8, D-40880 Ratingen, Germany
Tel: +49-2102-486-0 / Fax: +49-2102-486-1120

24 UK FA Center

MITSUBISHI ELECTRIC EUROPE B.V. UK Branch
Travellers Lane, Hatfield, Hertfordshire, AL10 8XB, U.K.
Tel: +44-1707-28-8780 / Fax: +44-1707-27-8695

25 Czech Republic FA Center

MITSUBISHI ELECTRIC EUROPE B.V. Czech Branch
Avenir Business Park, Radlicka 751/113e, 158 00 Praha5, Czech Republic
Tel: +420-251-551-470 / Fax: +420-251-551-471

26 Russia FA Center

MITSUBISHI ELECTRIC EUROPE B.V. Russian Branch St. Petersburg office
Piskarevsky pr. 2, bld 2, lit "Sch", BC "Benua", office 720; 195027, St. Petersburg, Russia
Tel: +7-812-633-3497 / Fax: +7-812-633-3499

27 Turkey FA Center

MITSUBISHI ELECTRIC TURKEY A.Ş Umraniye Branch
Serifali Mahallesi Nutuk Sokak No:5, TR-34775 Umraniye, Istanbul, Turkey
Tel: +90-216-526-3990 / Fax: +90-216-526-3995

Factory Automation Global website

Mitsubishi Electric Factory Automation provides a mix of services to support its customers worldwide. A consolidated global website is the main portal, offering a selection of support tools and a window to its local Mitsubishi Electric sales and support network.

■ From here you can find:

- Overview of available factory automation products
- Library of downloadable literature
- Support tools such as online e-learning courses, terminology dictionary, etc.
- Global sales and service network portal
- Latest news related to Mitsubishi Electric factory automation

Mitsubishi Electric Factory Automation
Global website:

www.MitsubishiElectric.com/fa

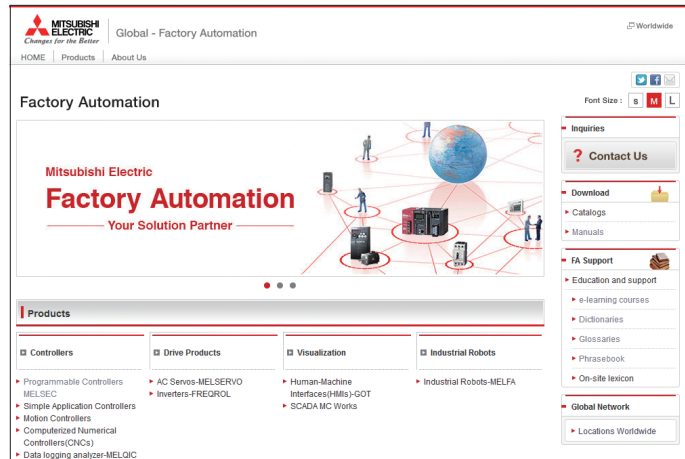

Online e-learning

An extensive library of e-learning courses covering the factory automation product range has been prepared. Courses from beginner to advanced levels of difficulty are available in various languages.

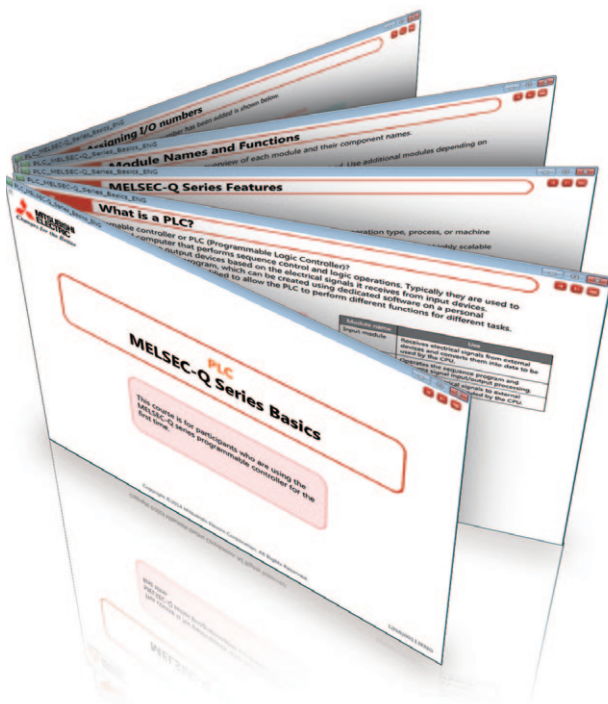

■ Beginner level

Designed for newcomers to Mitsubishi Electric Factory Automation products gaining a background of the fundamentals and an overview of various products related to the course.

■ Basic to Advanced levels

These courses are designed to provide education at all levels. Various different features are explained with application examples providing an easy and informative resource for in-house company training.



Innovative next-generation, e-manual

The e-manual viewer is a next-generation digital manual offered by Mitsubishi Electric that consolidates all manuals into an easy-to-use package with various useful features integrated into the viewer. The e-manual is modeled around a centralized database allowing multiple manuals to be cross-searched at once, further reducing the time for reading individual product manuals when setting up a control system.



Key features include

- One-stop database containing all required manuals, with local file cache
- Bundled with GX Works3 engineering software
- Easily download manuals all at once
- Automatic update of manual versions
- Search information across multiple manuals
- Visual navigation from hardware diagram showing various specifications
- Customizable by adding user notes and bookmarks
- Directly port sample programs within manuals to GX Works3

Compliance with international quality assurance standards

All of Mitsubishi Electric's FA products have acquired the international quality assurance "ISO9001" and environmental management system standard "ISO14001" certification. Mitsubishi Electric FA products also comply with many safety and shipping standards, including CE, UL, ABS, and DNV.

*For jointly developed and partner products, guaranteed quality standards may differ. Please refer to the product manuals for details.

Safety Standards

	CE : Council Directive of the European Communities		UL : Underwriters Laboratories Listing
--	--	--	--

Shipping Standards

	LR : Lloyd's Register of Shipping approval		DNV : Norwegian Maritime approval		RINA : Italian Maritime approval
	NK : ClassNK approval		ABS : American Bureau of Shipping approval		BV : Bureau Veritas approval
	GL : Germanischer Lloyd approval				

Product List

*Always refer to user's manuals for information on usable modules, restrictions, etc. before using.

[Legend] **DB** : Double brand product (Note) **NEW** : Recently released product **SOON** : Product available soon

CPU module

Type	Model	Outline	
High-speed Universal model QCPU	Q03UDVCPU	No. of I/O points: 4096 points, no. of I/O device points: 8192 points, program capacity: 30K steps, basic operation processing speed (LD instruction): 1.9 ns, program memory capacity: 120 KB, peripheral connection ports: USB, Ethernet (Predefined protocol support function), memory card I/F: SD memory card and extended SRAM cassette	
	Q04UDVCPU	No. of I/O points: 4096 points, no. of I/O device points: 8192 points, program capacity: 40K steps, basic operation processing speed (LD instruction): 1.9 ns, program memory capacity: 160 KB, peripheral connection ports: USB, Ethernet (Predefined protocol support function), memory card I/F: SD memory card and extended SRAM cassette	
	Q06UDVCPU	No. of I/O points: 4096 points, no. of I/O device points: 8192 points, program capacity: 60K steps, basic operation processing speed (LD instruction): 1.9 ns, program memory capacity: 240 KB, peripheral connection ports: USB, Ethernet (Predefined protocol support function), memory card I/F: SD memory card and extended SRAM cassette	
	Q13UDVCPU	No. of I/O points: 4096 points, no. of I/O device points: 8192 points, program capacity: 130K steps, basic operation processing speed (LD instruction): 1.9 ns, program memory capacity: 520 KB, peripheral connection ports: USB, Ethernet (Predefined protocol support function), memory card I/F: SD memory card and extended SRAM cassette	
	Q26UDVCPU	No. of I/O points: 4096 points, no. of I/O device points: 8192 points, program capacity: 260K steps, basic operation processing speed (LD instruction): 1.9 ns, program memory capacity: 1040 KB, peripheral connection ports: USB, Ethernet (Predefined protocol support function), memory card I/F: SD memory card and extended SRAM cassette	
Universal model QCPU	Q00UJCPU	No. of I/O points: 256 points, no. of I/O device points: 8192 points, program capacity: 10K steps, basic operation processing speed (LD instruction): 120 ns, program memory capacity: 40 KB, peripheral connection ports: USB and RS-232, no memory card I/F, 5-slot base, with 100...240 V AC input/5 V DC/3 A output power supply	
	Q00UCPU	No. of I/O points: 1024 points, no. of I/O device points: 8192 points, program capacity: 10K steps, basic operation processing speed (LD instruction): 80 ns, program memory capacity: 40 KB, peripheral connection ports: USB and RS-232, no memory card I/F	
	Q01UCPU	No. of I/O points: 1024 points, no. of I/O device points: 8192 points, program capacity: 15K steps, basic operation processing speed (LD instruction): 60 ns, program memory capacity: 60 KB, peripheral connection ports: USB and RS-232, no memory card I/F	
	Q02UCPU	No. of I/O points: 2048 points, no. of I/O device points: 8192 points, program capacity: 20K steps, basic operation processing speed (LD instruction): 40 ns, program memory capacity: 80 KB, peripheral connection ports: USB and RS-232, memory card I/F: SRAM card, FLASH card, and ATA card	
	Q03UDCPU	No. of I/O points: 4096 points, no. of I/O device points: 8192 points, program capacity: 30K steps, basic operation processing speed (LD instruction): 20 ns, program memory capacity: 120 KB, multiple CPU high-speed communication, peripheral connection ports: USB and RS-232, memory card I/F: SRAM card, FLASH card, and ATA card	
	Q04UDHCPU	No. of I/O points: 4096 points, no. of I/O device points: 8192 points, program capacity: 40K steps, basic operation processing speed (LD instruction): 9.5 ns, program memory capacity: 160 KB, multiple CPU high-speed communication, peripheral connection ports: USB and RS-232, memory card I/F: SRAM card, FLASH card, and ATA card	
	Q06UDHCPU	No. of I/O points: 4096 points, no. of I/O device points: 8192 points, program capacity: 60K steps, basic operation processing speed (LD instruction): 9.5 ns, program memory capacity: 240 KB, multiple CPU high-speed communication, peripheral connection ports: USB and RS-232, memory card I/F: SRAM card, FLASH card, and ATA card	
	Q10UDHCPU	No. of I/O points: 4096 points, no. of I/O device points: 8192 points, program capacity: 100K steps, basic operation processing speed (LD instruction): 9.5 ns, program memory capacity: 400 KB, multiple CPU high-speed communication, peripheral connection ports: USB and RS-232, memory card I/F: SRAM card, FLASH card, and ATA card	
	Q13UDHCPU	No. of I/O points: 4096 points, no. of I/O device points: 8192 points, program capacity: 130K steps, basic operation processing speed (LD instruction): 9.5 ns, program memory capacity: 520 KB, multiple CPU high-speed communication, peripheral connection ports: USB and RS-232, memory card I/F: SRAM card, FLASH card, and ATA card	
	Q20UDHCPU	No. of I/O points: 4096 points, no. of I/O device points: 8192 points, program capacity: 200K steps, basic operation processing speed (LD instruction): 9.5 ns, program memory capacity: 800 KB, multiple CPU high-speed communication, peripheral connection ports: USB and RS-232, memory card I/F: SRAM card, FLASH card, and ATA card	
	Q26UDHCPU	No. of I/O points: 4096 points, no. of I/O device points: 8192 points, program capacity: 260K steps, basic operation processing speed (LD instruction): 9.5 ns, program memory capacity: 1040 KB, multiple CPU high-speed communication, peripheral connection ports: USB and RS-232, memory card I/F: SRAM card, FLASH card, and ATA card	
	Built-in Ethernet type	Q03UDECPU	No. of I/O points: 4096 points, no. of I/O device points: 8192 points, program capacity: 30K steps, basic operation processing speed (LD instruction): 20 ns, program memory capacity: 120 KB, multiple CPU high-speed communication, peripheral connection ports: USB and Ethernet, memory card I/F: SRAM card, FLASH card, and ATA card
		Q04UDEHCPU	No. of I/O points: 4096 points, no. of I/O device points: 8192 points, program capacity: 40K steps, basic operation processing speed (LD instruction): 9.5 ns, program memory capacity: 160 KB, multiple CPU high-speed communication, peripheral connection ports: USB and Ethernet, memory card I/F: SRAM card, FLASH card, and ATA card
		Q06UDEHCPU	No. of I/O points: 4096 points, no. of I/O device points: 8192 points, program capacity: 60K steps, basic operation processing speed (LD instruction): 9.5 ns, program memory capacity: 240 KB, multiple CPU high-speed communication, peripheral connection ports: USB and Ethernet, memory card I/F: SRAM card, FLASH card, and ATA card
Q10UDEHCPU		No. of I/O points: 4096 points, no. of I/O device points: 8192 points, program capacity: 100K steps, basic operation processing speed (LD instruction): 9.5 ns, program memory capacity: 400 KB, multiple CPU high-speed communication, peripheral connection ports: USB and Ethernet, memory card I/F: SRAM card, FLASH card, and ATA card	
Q13UDEHCPU		No. of I/O points: 4096 points, no. of I/O device points: 8192 points, program capacity: 130K steps, basic operation processing speed (LD instruction): 9.5 ns, program memory capacity: 520 KB, multiple CPU high-speed communication, peripheral connection ports: USB and Ethernet, memory card I/F: SRAM card, FLASH card, and ATA card	
Q20UDEHCPU		No. of I/O points: 4096 points, no. of I/O device points: 8192 points, program capacity: 200K steps, basic operation processing speed (LD instruction): 9.5 ns, program memory capacity: 800 KB, multiple CPU high-speed communication, peripheral connection ports: USB and Ethernet, memory card I/F: SRAM card, FLASH card, and ATA card	
Q26UDEHCPU		No. of I/O points: 4096 points, no. of I/O device points: 8192 points, program capacity: 260K steps, basic operation processing speed (LD instruction): 9.5 ns, program memory capacity: 1040 KB, multiple CPU high-speed communication, peripheral connection ports: USB and Ethernet, memory card I/F: SRAM card, FLASH card, and ATA card	
Q50UDEHCPU		No. of I/O points: 4096 points, no. of I/O device points: 8192 points, program capacity: 500K steps, basic operation processing speed (LD instruction): 9.5 ns, program memory capacity: 2000 KB, multiple CPU high-speed communication, peripheral connection ports: USB and Ethernet, memory card I/F: SRAM card, FLASH card, and ATA card	
Q100UDEHCPU		No. of I/O points: 4096 points, no. of I/O device points: 8192 points, program capacity: 1000K steps, basic operation processing speed (LD instruction): 9.5 ns, program memory capacity: 4000 KB, multiple CPU high-speed communication, peripheral connection ports: USB and Ethernet, memory card I/F: SRAM card, FLASH card, and ATA card	

Note: General specifications and product guarantee conditions of jointly developed products are different from those of MELSEC products. For more information, please refer to the product manuals or contact your local Mitsubishi representative for details.



CPU module

Type	Model	Outline	
Basic model QCPU	Q00JCPU	No. of I/O points: 256 points, no. of I/O device points: 2048 points, program capacity: 8K steps, basic operation processing speed (LD instruction): 200 ns, program memory capacity: 58 KB, peripheral connection ports: RS-232, no memory card I/F, 5-slot base, with 100...240 V AC input/5 V DC/3 A output power supply	
	Q00CPU	No. of I/O points: 1024 points, no. of I/O device points: 2048 points, program capacity: 8K steps, basic operation processing speed (LD instruction): 160 ns, program memory capacity: 94 KB, peripheral connection ports: RS-232, no memory card I/F	
	Q01CPU	No. of I/O points: 1024 points, no. of I/O device points: 2048 points, program capacity: 14K steps, basic operation processing speed (LD instruction): 100 ns, program memory capacity: 94 KB, peripheral connection ports: RS-232, no memory card I/F	
High Performance model QCPU	Q02CPU	No. of I/O points: 4096 points, no. of I/O device points: 8192 points, program capacity: 28K steps, basic operation processing speed (LD instruction): 79 ns, program memory capacity: 112 KB, peripheral connection ports: RS-232, memory card I/F: SRAM card, FLASH card, and ATA card	
	Q02HCPU	No. of I/O points: 4096 points, no. of I/O device points: 8192 points, program capacity: 28K steps, basic operation processing speed (LD instruction): 34 ns, program memory capacity: 112 KB, peripheral connection ports: USB and RS-232, memory card I/F: SRAM card, FLASH card, and ATA card	
	Q06HCPU	No. of I/O points: 4096 points, no. of I/O device points: 8192 points, program capacity: 60K steps, basic operation processing speed (LD instruction): 34 ns, program memory capacity: 240 KB, peripheral connection ports: USB and RS-232, memory card I/F: SRAM card, FLASH card, and ATA card	
	Q12HCPU	No. of I/O points: 4096 points, no. of I/O device points: 8192 points, program capacity: 124K steps, basic operation processing speed (LD instruction): 34 ns, program memory capacity: 496 KB, peripheral connection ports: USB and RS-232, memory card I/F: SRAM card, FLASH card, and ATA card	
	Q25HCPU	No. of I/O points: 4096 points, no. of I/O device points: 8192 points, program capacity: 252K steps, basic operation processing speed (LD instruction): 34 ns, program memory capacity: 1008 KB, peripheral connection ports: USB and RS-232, memory card I/F: SRAM card, FLASH card, and ATA card	
Process CPU	Q02PHCPU	No. of I/O points: 4096 points, no. of I/O device points: 8192 points, program capacity: 28K steps, basic operation processing speed (LD instruction): 34 ns, program memory capacity: 112 KB, peripheral connection ports: USB and RS-232, memory card I/F: SRAM card, FLASH card, and ATA card	
	Q06PHCPU	No. of I/O points: 4096 points, no. of I/O device points: 8192 points, program capacity: 60K steps, basic operation processing speed (LD instruction): 34 ns, program memory capacity: 240 KB, peripheral connection ports: USB and RS-232, memory card I/F: SRAM card, FLASH card, and ATA card	
	Q12PHCPU	No. of I/O points: 4096 points, no. of I/O device points: 8192 points, program capacity: 124K steps, basic operation processing speed (LD instruction): 34 ns, program memory capacity: 496 KB, peripheral connection ports: USB and RS-232, memory card I/F: SRAM card, FLASH card, and ATA card	
	Q25PHCPU	No. of I/O points: 4096 points, no. of I/O device points: 8192 points, program capacity: 252K steps, basic operation processing speed (LD instruction): 34 ns, program memory capacity: 1008 KB, peripheral connection ports: USB and RS-232, memory card I/F: SRAM card, FLASH card, and ATA card	
Redundant CPU	Q12PRHCPU	No. of I/O points: 4096 points, no. of I/O device points: 8192 points, program capacity: 124K steps, basic operation processing speed (LD instruction): 34 ns, program memory capacity: 496 KB, peripheral connection ports: USB and RS-232, memory card I/F: SRAM card, FLASH card, and ATA card	
	Q25PRHCPU	No. of I/O points: 4096 points, no. of I/O device points: 8192 points, program capacity: 252K steps, basic operation processing speed (LD instruction): 34 ns, program memory capacity: 1008 KB, peripheral connection ports: USB and RS-232, memory card I/F: SRAM card, FLASH card, and ATA card	
Tracking cable	QC10TR	Tracking cable 1 m	
	QC30TR	Tracking cable 3 m	
C Controller CPU	Q24DHCCPU-V	No. of I/O points: 4096 points, endian format: little endian, removable storage: SD memory card, OS: VxWorks® Version 6.8.1	
	Q24DHCCPU-LS	No. of I/O points: 4096 points, endian format: little endian, removable storage: SD memory card, OS: No pre-installed operating system (Operating system installed by user)	
	Q12DCCPU-V	No. of I/O points: 4096 points, endian format: little endian, removable storage: CompactFlash card, OS: VxWorks® Version 6.4	
	Q06CCPU-V	No. of I/O points: 4096 points, endian format: little endian, removable storage: CompactFlash card, OS: VxWorks® Version 5.4	
	Bundled product	Q24DHCCPU-V-B019	C Controller (Q24DHCCPU-V) bundled with CIMSNIPER Q24 E, data collection package for EES/FDC/APC (equipped with Simple MES functionality)
		Q24DHCCPU-V-B01D	C Controller (Q24DHCCPU-V) bundled with DNA Designer Q24 E, model based development support tool
		Q24DHCCPU-VG-B000	C Controller (Q24DHCCPU-VG) bundled with GENWARE®3-VG Runtime License Version, runtime library is pre-installed
		Q24DHCCPU-VG-B002	C Controller (Q24DHCCPU-VG) bundled with GENWARE®3-VG Tool License Version, GUI development environment (CI SKETCH-E) is bundled into the Runtime License version
		Q24DHCCPU-LS-B030 NEW	C Controller (Q24DHCCPU-LS) bundled with Lineo uLinux and uLinux Station, web-based application that enables basic Linux system configuration
		Q12DCCPU-V-B011	C Controller (Q12DCCPU-V) bundled with CIMOPERATOR® SECS+ for ADVANCED E, supports SECS-I (SEMI E4), HSMS (SEMI E37)
		Q12DCCPU-V-B013	C Controller (Q12DCCPU-V) bundled with CIMOPERATOR® SECS+ for GEM ADVANCED E, middle kit version that supports GEM (E30) (does not support Trace data collection, Limit monitoring, Document file output)
		Q12DCCPU-V-B015	C Controller (Q12DCCPU-V) bundled with CIMOPERATOR® SECS+ for GEM ADVANCED (Option Pack) E, full kit version that supports GEM (E30) (supports Trace data collection, Limit monitoring, Document file output)
		Q12DCCPU-V-B019	C Controller (Q12DCCPU-V) bundled with CIMSNIPER E, data collection package for EES/FDC/APC (equipped with Simple MES functionality)
		Q12DCCPU-V-B01B	C Controller (Q12DCCPU-V) bundled with CIMSNIPER Light E, data collection package for EES/FDC/APC (not equipped with Simple MES functionality)
	Q12DCCPU-V-B01D	C Controller (Q12DCCPU-V) bundled with DNA Designer E, model based development support tool	
Cable	Q12DCCPU-CBL *1*2*3	RS-232 connection converter cable (custom mini-DIN to 9-pin D-sub connector)	

*1: For use with Q24DHCCPU-V, Q24DHCCPU-VG.

*2: For use with Q24DHCCPU-LS.

*3: For use with Q12DCCPU-V.

CPU module

Type	Model	Outline
Battery	Q6BAT	Replacement battery
	Q7BAT	Replacement large-capacity battery
	Q7BAT-SET	Large-capacity battery with holder for installing CPU
	Q8BAT	Replacement large-capacity battery module
	Q8BAT-SET	Large-capacity battery module with CPU connection cable
Extended SRAM cassette	Q4MCA-1MBS*1	Extended SRAM cassette, capacity: 1 MB
	Q4MCA-2MBS*1	Extended SRAM cassette, capacity: 2 MB
	Q4MCA-4MBS*1	Extended SRAM cassette, capacity: 4 MB
	Q4MCA-8MBS*1	Extended SRAM cassette, capacity: 8 MB
SD memory card	NZ1MEM-2GBSD*1*2*3*4 NEW	SD memory card, capacity: 2 GB
	NZ1MEM-4GBSD*1*2*3*4 NEW	SDHC memory card, capacity: 4 GB
	NZ1MEM-8GBSD*1*2*3*4 NEW	SDHC memory card, capacity: 8 GB
	NZ1MEM-16GBSD*1*2*3*4 NEW	SDHC memory card, capacity: 16 GB
	L1MEM-2GBSD*1*2*3*4	SD memory card, capacity: 2 GB, to be discontinued (July 2015)
	L1MEM-4GBSD*1*2*3*4	SDHC memory card, capacity: 4 GB, to be discontinued (July 2015)
Memory card	Q2MEM-1MBS*5	SRAM memory card, capacity: 1 MB
	Q2MEM-2MBS*5	SRAM memory card, capacity: 2 MB
	Q3MEM-4MBS*5	SRAM memory card, capacity: 4 MB
	Q3MEM-4MBS-SET*5	SRAM memory card with cover, capacity: 4 MB
	Q3MEM-8MBS*5	SRAM memory card, capacity: 8 MB
	Q3MEM-8MBS-SET*6	SRAM memory card with cover, capacity: 8 MB
	Q3MEM-CV	Memory card protective cover for the Universal model QCPU (comes with Q3MEM-4MBS-SET/Q3MEM-8MBS-SET)
	Q3MEM-CV-H	Memory card protective cover for the High Performance model, Process, and Redundant CPUs (comes with Q3MEM-4MBS-SET)
	Q2MEM-8MBA*5	ATA card, capacity: 8 MB, to be discontinued (December 2016)
	Q2MEM-16MBA*5	ATA card, capacity: 16 MB
Q2MEM-32MBA*5	ATA card, capacity: 32 MB	
CompactFlash card	GT05-MEM-128MC*4*7	CompactFlash card, capacity: 128 MB
	GT05-MEM-256MC*4*7	CompactFlash card, capacity: 256 MB
	QD81MEM-512MBC*4*7*8	CompactFlash card, capacity: 512 MB
	QD81MEM-1GBC*4*8	CompactFlash card, capacity: 1 GB
	QD81MEM-2GBC*4*8	CompactFlash card, capacity: 2 GB
	QD81MEM-4GBC*4*8	CompactFlash card, capacity: 4 GB
	QD81MEM-8GBC*4*8	CompactFlash card, capacity: 8 GB
Memory card adapter	Q2MEM-ADP	Adapter for Q2MEM memory card's standard PCMCIA slot
SRAM card battery	Q2MEM-BAT	Replacement battery for Q2MEM-1MBS and Q2MEM-2MBS
	Q3MEM-BAT	Replacement battery for Q3MEM-4MBS and Q3MEM-8MBS
Connection cable	QC30R2	RS-232 cable for connecting PC and CPU, 3 m (between mini-DIN6P and Dsub9P)
Cable disconnection prevention holder	Q6HLD-R2	Holder for preventing RS-232 cable (Programmable Controller CPU connection) disconnection

*1: For use with QnUDVCP.

*2: For use with Q24DHCCPU-V, Q24DHCCPU-VG.

*3: For use with Q24DHCCPU-LS.

*4: Mitsubishi Electric shall not guarantee the operation of any non-Mitsubishi Electric products.

*5: For use with the Universal model QCPUs (except QnUDV), High Performance model QCPUs, process CPUs, and redundant CPUs that are equipped with the memory card interface.

*6: For use with the Universal model QCPUs (except QnUDV) that are equipped with the memory card interface.

*7: For use with Q06CCPU-V.

*8: For use with Q12DCCPU-V.



Base unit

Type	Model	Outline
Main base	Q33B	3 slots, 1 power supply module required, for Q Series modules
	Q35B	5 slots, 1 power supply module required, for Q Series modules
	Q38B	8 slots, 1 power supply module required, for Q Series modules
	Q312B	12 slots, 1 power supply module required, for Q Series modules
Multiple CPU high speed main base	Q35DB	5 slots, power supply module required, for Q Series modules
	Q38DB	8 slots, 1 power supply module required, for Q Series modules
	Q312DB	12 slots, 1 power supply module required, for Q Series modules
Slim type main base	Q32SB	2 slots, 1 slim type power supply module required, for Q Series modules
	Q33SB	3 slots, 1 slim type power supply module required, for Q Series modules
	Q35SB	5 slots, 1 slim type power supply module required, for Q Series modules
Redundant power main base	Q38RB	8 slots, 2 redundant power supply modules required, for Q Series modules
Extension base	Q63B	3 slots, 1 power supply module required, for Q Series modules
	Q65B	5 slots, 1 power supply module required, for Q Series modules
	Q68B	8 slots, 1 power supply module required, for Q Series modules
	Q612B	12 slots, 1 power supply module required, for Q Series modules
	Q52B	2 slots, power supply module not required, for Q Series modules
	Q55B	5 slots, power supply module not required, for Q Series modules
Redundant power extension base	Q68RB	8 slots, 2 redundant power supply modules required, for Q Series modules
Redundant type extension base	Q65WRB*1	5 slots, 2 redundant power supply modules required, for Q Series modules
Extension cable	QC05B	0.45 m cable for connecting extension base unit
	QC06B	0.6 m cable for connecting extension base unit
	QC12B	1.2 m cable for connecting extension base unit
	QC30B	3 m cable for connecting extension base unit
	QC50B	5 m cable for connecting extension base unit
	QC100B	10 m cable for connecting extension base unit
DIN rail mounting adapter	Q6DIN1	DIN rail mounting adapter for Q38B, Q312B, Q68B, Q612B, Q38RB, Q68RB, Q65WRB, Q38DB, and Q312DB
	Q6DIN2	DIN rail mounting adapter for Q35B, Q65B, Q00JCPU, and Q00UJCPU
	Q6DIN3	DIN rail mounting adapter for Q32SB, Q33SB, Q35SB, Q33B, Q52B, Q55B, and Q63B
	Q6DIN1A	DIN rail mounting adapter (with vibration-proofing bracket set) for Q3□B, Q5□B, Q6□B, Q38RB, Q68RB, and Q65WRB
Blank cover	QG60	Blank cover for I/O slot

*1: Only compatible with redundant CPU system.

Power supply module

Power supply	Q61P	Input voltage: 100...240 V AC, output voltage: 5 V DC, output current: 6 A
	Q62P	Input voltage: 100...240 V AC, output voltage: 5/24 V DC, output current: 3/0.6 A
	Q63P	Input voltage: 24 V DC, output voltage: 5 V DC, output current: 6 A
	Q64PN	Input voltage: 100...240 V AC, output voltage: 5 V DC, output current: 8.5 A
Power supply with life detection	Q61P-D	Input voltage: 100...240 V AC, output voltage: 5 V DC, output current: 6 A
Slim type power supply	Q61SP	Input voltage: 100...240 V AC, output voltage: 5 V DC, output current: 2 A
Redundant power supply	Q63RP	Input voltage: 24 V DC, output voltage: 5 V DC, output current: 8.5 A
	Q64RPN	Input voltage: 100...240 V AC, output voltage: 5 V DC, output current: 8.5 A
	Q64RP	Input voltage: 100...120/200...240 V AC, output voltage: 5 V DC, output current: 8.5 A, to be discontinued (September 2015)

I/O module

Type	Model	Outline		
Input	AC	QX10	16 points, 100...120 V AC, response time: 20 ms, 16 points/common, 18-point terminal block	
		QX10-TS	16 points, 100...120 V AC, response time: 20 ms, 16 points/common, 18-point spring clamp terminal block	
		QX28	8 points, 100...240 V AC, response time: 20 ms, 8 points/common, 18-point terminal block	
	DC (Positive common) ^{*1}	QX40	16 points, 24 V DC, response time: 1/5/10/20/70 ms, 16 points/common, positive common, 18-point terminal block	
		QX40-TS	16 points, 24 V DC, response time: 1/5/10/20/70 ms, 16 points/common, positive common, 18-point spring clamp terminal block	
		QX40-S1	16 points, 24 V DC, response time: 0.1/0.2/0.4/0.6/1 ms, 16 points/common, positive common, 18-point terminal block	
		QX40H	16 points, 24 V DC, response time: 0/0.1/0.2/0.4/0.6/1 ms, 8 points/common, positive common, 18-point terminal block	
		QX41 ^{*2} ^{*3}	32 points, 24 V DC, response time: 1/5/10/20/70 ms, 32 points/common, positive common, 40-pin connector	
		QX41-S1 ^{*2}	32 points, 24 V DC, response time: 0.1/0.2/0.4/0.6/1 ms, 32 points/common, positive common, 40-pin connector	
		QX41-S2 ^{*2} ^{*3}	32 points, 24 V DC, response time: 1/5/10/20/70 ms, 32 points/common, positive common, 40-pin connector	
	AC/DC	QX42 ^{*2}	64 points, 24 V DC, response time: 1/5/10/20/70 ms, 32 points/common, positive common, 40-pin connector	
		QX42-S1 ^{*2}	64 points, 24 V DC, response time: 0.1/0.2/0.4/0.6/1 ms, 32 points/common, positive common, 40-pin connector	
	DC sensor	QX50	16 points, 48 V AC/DC, response time: 20 ms, 16 points/common, positive/negative common, 18-point terminal block	
		QX70	16 points, 5/12 V DC, response time: 1/5/10/20/70 ms, 16 points/common, positive/negative common, 18-point terminal block	
		QX70H	16 points, 5 V DC, response time: 0/0.1/0.2/0.4/0.6/1 ms, 8 points/common, positive common, 18-point terminal block	
	DC (Negative common) ^{*1}	QX71 ^{*2}	32 points, 5/12 V DC, response time: 1/5/10/20/70 ms, 32 points/common, positive/negative common, 40-pin connector	
		QX72 ^{*2}	64 points, 5/12 V DC, response time: 1/5/10/20/70 ms, 32 points/common, positive/negative common, 40-pin connector	
		QX80	16 points, 24 V DC, response time: 1/5/10/20/70 ms, 16 points/common, negative common, 18-point terminal block	
		QX80-TS	16 points, 24 V DC, response time: 1/5/10/20/70 ms, 16 points/common, negative common, 18-point spring clamp terminal block	
		QX80H	16 points, 24 V DC, response time: 0/0.1/0.2/0.4/0.6/1 ms, 8 points/common, negative common, 18-point terminal block	
		QX81 ^{*3} ^{*4}	32 points, 24 V DC, response time: 1/5/10/20/70 ms, 32 points/common, negative common, 37-pin D-sub connector	
		QX81-S2 ^{*3} ^{*4}	32 points, 24 V DC, response time: 1/5/10/20/70 ms, 32 points/common, negative common, 37-pin D-sub connector	
		QX82 ^{*2}	64 points, 24 V DC, response time: 1/5/10/20/70 ms, 32 points/common, negative common, 40-pin connector	
	Output	Relay	QX82-S1 ^{*2}	64 points, 24 V DC, response time: 0.1/0.2/0.4/0.6/1 ms, 32 points/common, negative common, 40-pin connector
			QX90H	16 points, 5 V DC, response time: 0/0.1/0.2/0.4/0.6/1 ms, 8 points/common, negative common, 18-point terminal block
			QY10	16 points, 24 V DC/240 V AC, 2 A/point, 8 A/common, response time: 12 ms, 16 points/common, 18-point terminal block
		Triac	QY10-TS	16 points, 24 V DC/240 V AC, 2 A/point, 8 A/common, response time: 12 ms, 16 points/common, 18-point spring clamp terminal block
QY18A			8 points, 24 V DC/240 V AC, 2 A/point, response time: 12 ms, 18-point terminal block, all points independent	
Transistor (Sink)		QY22	16 points, 100...240 V AC, 0.6 A/point, 4.8 A/common, response time: 1 ms + 0.5 cycle, 16 points/common, 18-point terminal block, with surge suppression	
		QY40P	16 points, 12...24 V DC, 0.1 A/point, 1.6 A/common, response time: 1 ms, 16 points/common, sink type, 18-point terminal block, overload protection function, overheat protection function, surge suppression	
		QY40P-TS	16 points, 12...24 V DC, 0.1 A/point, 1.6 A/common, response time: 1 ms, 16 points/common, sink type, 18-point spring clamp terminal block, overload protection function, overheat protection function, surge suppression	
		QY41H	32 points, 5...24 V DC, 0.2 A/point, 2 A/common, response time: 2 us, 32 points/common, sink type, 40-pin connector, with surge suppression	
		QY41P ^{*2}	32 points, 12...24 V DC, 0.1 A/point, 2 A/common, response time: 1 ms, 32 points/common, sink type, 40-pin connector, overload protection function, overheat protection function, surge suppression	
		QY42P ^{*2}	64 points, 12...24 V DC, 0.1 A/point, 2 A/common, response time: 1 ms, 32 points/common, sink type, 40-pin connector, overload protection function, overheat protection function, surge suppression	
		QY50	16 points, 12...24 V DC, 0.5 A/point, 4 A/common, response time: 1 ms, 16 points/common, sink type, 18-point terminal block, with surge suppression and fuse	
		Transistor (Independent)	QY68A	8 points, 5...24 V DC, 2 A/point, 8 A/module, response time: 10 ms, sink/source type, 18-point terminal block, with surge suppression, all points independent
			QY70	16 points, 5...12 V DC, 16 mA/point, 256 mA/common, response time: 0.5 ms, 16 points/common, sink type, 18-point terminal block, with fuse
		TTL CMOS	QY71 ^{*2}	32 points, 5...12 V DC, 16 mA/point, 512 mA/common, response time: 0.5 ms, 32 points/common, sink type, 40-pin connector, with fuse
QY80			16 points, 12...24 V DC, 0.5 A/point, 4 A/common, response time: 1 ms, 16 points/common, source type, 18-point terminal block, with surge suppression and fuse	
Transistor (Source)		QY80-TS	16 points, 12...24 V DC, 0.5 A/point, 4 A/common, response time: 1 ms, 16 points/common, source type, 18-point spring clamp terminal block, with surge suppression and fuse	
		QY81P ^{*4}	32 points, 12...24 V DC, 0.1 A/point, 2 A/common, response time: 1 ms, 32 points/common, source type, 37-pin D-sub connector, overload protection function, overheat protection function, surge suppression	
		QY82P ^{*2}	64 points, 12...24 V DC, 0.1 A/point, 2 A/common, response time: 1 ms, 32 points/common, source type, 40-pin connector, overload protection function, overheat protection function, surge suppression	
		QY82P ^{*2} ^{*5}	64 points, 12...24 V DC, 0.1 A/point, 2 A/common, response time: 1 ms, 32 points/common, source type, 40-pin connector, overload protection function, overheat protection function, surge suppression	
I/O		DC input/ transistor output	QH42P ^{*2} ^{*5}	Input: 32 points, 24 V DC, response time: 1/5/10/20/70 ms, 32 points/common, positive common, output: 32 points, 12...24 V DC, 0.1 A/point, 2 A/common, response time: 1 ms, 32 points/common, sink type, 40-pin connector, overload protection function, overheat protection function, surge suppression
			QX48Y57	Input: 8 points, 24 V DC, response time: 1/5/10/20/70 ms, 8 points/common, positive common, output: 7 points, 12...24 V DC, 0.5 A/point, 2 A/common, response time: 1 ms, 7 points/common, sink type, 18-point terminal block, with surge suppression and fuse
			QX41Y41P ^{*2} ^{*5}	Input: 32 points, 24 V DC, response time: 1/5/10/20/70 ms, 32 points/common, positive common, output: 32 points, 12...24 V DC, 0.1 A/point, 2 A/common, response time: 1 ms, 32 points/common, sink type, 40-pin connector, overload protection function, overheat protection function, surge suppression
Interrupt module		QI60	16 points, 24 V DC, response time: 0.1/0.2/0.4/0.6/1 ms, 16 points/common, 18-point terminal block	

*1: "Positive common" indicates that the positive lead of a DC power supply must be connected to the common terminal.

Accordingly, "Negative common" indicates that the negative lead must be connected to the common terminal.

*2: Connector is not provided. Separately order one of the following: A6CON1/A6CON2/A6CON3/A6CON4.

*3: The rated input currents are different. [QX41: approx. 4 mA, QX41-S2: approx. 6 mA, QX81: approx. 4 mA, QX81-S2: approx. 6 mA]

*4: Connector is not provided. Separately order one of the following: A6CON1E/A6CON2E/A6CON3E.

*5: The number of occupied input/output points is different. [QH42P: 32 points; QX41Y41P: 64 points (first 32 points: input/second 32 points: output)]



I/O module

Type	Model	Outline	
Connector	A6CON1	32-point connector soldering type (40-pin connector)	
	A6CON2	32-point connector crimp-contact type (40-pin connector)	
	A6CON3	32-point connector pressure-displacement (flat cable) type (40-pin connector)	
	A6CON4	32-point connector soldering type (40-pin connector, cable connectable in bidirection)	
	A6CON1E	32-point connector soldering type (37-pin D-sub connector)	
	A6CON2E	32-point connector crimp-contact type (37-pin D-sub connector)	
	A6CON3E	32-point connector pressure-displacement (flat cable) type (37-pin D-sub connector)	
Spring clamp terminal block	Q6TE-18SN	For 16-point I/O modules, 0.3...1.5 mm ² (22...16 AWG)	
Terminal block adapter	Q6TA32	For 32-point I/O modules, 0.5 mm ² (20 AWG)	
	Q6TA32-TOL	Q6TA32 dedicated tool	
Connector/terminal block conversion module	A6TBXY36	For positive common input modules and sink output modules (standard type)	
	A6TBXY54	For positive common input modules and sink output modules (2-wire type)	
	A6TBX70	For positive common input modules (3-wire type)	
	A6TBX36-E	For negative common input modules (standard type)	
	A6TBX54-E	For negative common input modules (2-wire type)	
	A6TBX70-E	For negative common input modules (3-wire type)	
	A6TBY36-E	For source output modules (standard type)	
	A6TBY54-E	For source output modules (2-wire type)	
	Cable	AC05TB	For A6TBXY36, A6TBXY54, and A6TBX70 (positive common/sink type), 0.5 m
		AC10TB	For A6TBXY36, A6TBXY54, and A6TBX70 (positive common/sink type), 1 m
		AC20TB	For A6TBXY36, A6TBXY54, and A6TBX70 (positive common/sink type), 2 m
		AC30TB	For A6TBXY36, A6TBXY54, and A6TBX70 (positive common/sink type), 3 m
		AC50TB	For A6TBXY36, A6TBXY54, and A6TBX70 (positive common/sink type), 5 m
		AC80TB	For A6TBXY36, A6TBXY54, and A6TBX70 (positive common/sink type), 8 m *Common current 0.5 A or lower
		AC100TB	For A6TBXY36, A6TBXY54, and A6TBX70 (positive common/sink type), 10 m *Common current 0.5 A or lower
		AC05TB-E	For A6TBX36-E, A6TBY36-E, A6TBX54-E, A6TBY54-E, and A6TBX70-E (negative common/source type), 0.5 m
		AC10TB-E	For A6TBX36-E, A6TBY36-E, A6TBX54-E, A6TBY54-E, and A6TBX70-E (negative common/source type), 1 m
		AC20TB-E	For A6TBX36-E, A6TBY36-E, A6TBX54-E, A6TBY54-E, and A6TBX70-E (negative common/source type), 2 m
AC30TB-E		For A6TBX36-E, A6TBY36-E, A6TBX54-E, A6TBY54-E, and A6TBX70-E (negative common/source type), 3 m	
AC50TB-E		For A6TBX36-E, A6TBY36-E, A6TBX54-E, A6TBY54-E, and A6TBX70-E (negative common/source type), 5 m	
Relay terminal module	A6TE2-16SRN	For 40-pin connector 24 V DC transistor output modules (sink type)	
Cable	AC06TE	For A6TE2-16SRN, 0.6 m	
	AC10TE	For A6TE2-16SRN, 1 m	
	AC30TE	For A6TE2-16SRN, 3 m	
	AC50TE	For A6TE2-16SRN, 5 m	
	AC100TE	For A6TE2-16SRN, 10 m	

Analog I/O module

Analog input	Voltage input	Q68ADV	8 channels, input: -10...10 V DC, output (resolution): 0...4000, -4000...4000, 0...12000, -12000...12000, 0...16000, -16000...16000, conversion speed: 80 µs/channel, 18-point terminal block
		Current input	Q62AD-DGH
	Q66AD-DG*1		6 channels, input: 4...20 mA DC (when 2-wire transmitter is connected), 0...20 mA DC, output (resolution): 0...4000, 0...12000, conversion speed: 10 ms/channel, 40-pin connector, channel isolated, supplies power to 2-wire transmitter
	Q68ADI		8 channels, input: 0...20 mA DC, output (resolution): 0...4000, -4000...4000, 0...12000, -12000...12000, 0...16000, -16000...16000, conversion speed: 80 µs/channel, 18-point terminal block
	Voltage/current input	Q64AD	4 channels; input -10...10 V DC, 0...20 mA DC, output (resolution): 0...4000, -4000...4000, 0...12000, -12000...12000, 0...16000, -16000...16000, conversion speed: 80 µs/channel, 18-point terminal block
		Q64ADH	4 channels; input -10...10 V DC, 0...20 mA DC, output (resolution): 0...20000, -20000...20000, -5000...22500, conversion speed: 20 µs/channel, 18-point terminal block
		Q64AD-GH	4 channels, input: -10...10 V DC, 0...20 mA DC, output (resolution): 0...32000, -32000...32000, 0...64000, -64000...64000, conversion speed: 10 ms/4 channels, 18-point terminal block, channel isolated
		Q68AD-G*1	8 channels, input: -10...10 V DC, 0...20 mA DC, output (resolution): 0...4000, -4000...4000, 0...12000, -12000...12000, 0...16000, -16000...16000, conversion speed: 10 ms/channel, 40-pin connector, channel isolated

*1: A connector is not provided. The A6CON4 connector must be ordered separately.

Analog I/O module

Type		Model	Outline
Analog output	Voltage output	Q68DAVN	8 channels, input (resolution): 0...4000, -4000...4000, 0...12000, -12000...12000, -16000...16000, output: -10...10 V DC, conversion speed: 80 µs/channel, 18-point terminal block
	Current output	Q68DAIN	8 channels, input (resolution): 0...4000, -4000...4000, 0...12000, -12000...12000; output: 0...20 mA DC, conversion speed: 80 µs/channel, 18-point terminal block
	Voltage/current output	Q64DAH	4 channels, input (resolution): 0...20000, -20000...20000 output: -10...10 V DC, 0...20 mA DC, conversion speed: 20 µs/channel, 18-point terminal block
		Q62DAN	2 channels, input (resolution): 0...4000, -4000...4000, 0...12000, -12000...12000, -16000...16000, output: -10...10 V DC, 0...20 mA DC, conversion speed: 80 µs/channel, 18-point terminal block
		Q62DA-FG	2 channels, input (resolution): 0...12000, -12000...12000, -16000...16000, output: -12...12 V DC, 0...22 mA DC, conversion speed: 10 ms/2 channels, 18-point terminal block, channel isolated
		Q64DAN	4 channels, input (resolution): 0...4000, -4000...4000, 0...12000, -12000...12000, -16000...16000, output: -10...10 V DC, 0...20 mA DC, conversion speed: 80 µs/channel, 18-point terminal block
		Q66DA-G ^{*1}	6 channels, input (resolution): 0...4000, -4000...4000, 0...12000, -12000...12000, -16000...16000, output: -12...12 V DC, 0...22 mA DC, conversion speed: 6 ms/channel, 40-pin connector, channel isolated
Analog input/output	Voltage and current input/output	Q64AD2DA	Input: 4 channels, input: -10...10 V DC, 0...20 mA DC » output (resolution): 0...4000, -4000...4000, 0...12000, 0...16000, -16000...16000 » conversion speed: 500 µs/channel output: 2 channels input (resolution): 0...4000, -4000...4000, 0...12000, -16000...16000 » output: -10...10 V DC, 0...20 mA DC » conversion speed: 500 µs/channel 18-point terminal block
Load cell input	Q61LD	1 channel, input (load cell output): 0.0...3.3 mV/V, output (resolution): 0...10000, conversion speed: 10 ms, 18-point terminal block	
CT input module	Q68CT	8 channels, input: CT 0...5 A AC, 0...50 A AC, 0...100 A AC, 0...200 A AC, 0...400 A AC, 0...600 A AC, output: 0...10000, 18-point terminal block	
Temperature input	Thermocouple	Q64TD	4 channels, thermocouple (B, R, S, K, E, J, T, N), disconnection detection function, conversion speed: 40 ms/channel, channel isolated, 18-point terminal block
		Q64TDV-GH	4 channels, thermocouple (B, R, S, K, E, J, T, N), disconnection detection function, conversion speed: sampling cycle × 3, sampling cycle: 20 ms/channel, channel isolated, 18-point terminal block
		Q68TD-G-H01 ^{*1*2}	8 channels, thermocouple (B, R, S, K, E, J, T, N), disconnection detection function, conversion speed: 320 ms/8 channels, channel isolated, 40-pin connector
		Q68TD-G-H02 ^{*1}	8 channels, thermocouple (B, R, S, K, E, J, T, N), disconnection detection function, conversion speed: 640 ms/8 channels, channel isolated, 40-pin connector
	RTD	Q64RD	4 channels, platinum RTD (Pt100, JPt100), disconnection detection function, conversion speed: 40 ms/channel, 18-point terminal block
		Q64RD-G	4 channels, platinum RTD (Pt100, JPt100), nickel RTD (Ni100), disconnection detection function, conversion speed: 40 ms/channel, channel isolated, 18-point terminal block
		Q68RD3-G ^{*1}	8 channels, platinum RTD (Pt100, JPt100), nickel RTD (Ni100), disconnection detection function, conversion speed: 320 ms/8 channels, channel isolated, 40-pin connector
Temperature control	Thermocouple	Q64TCTTN	4 channels, thermocouple (K, J, T, B, S, E, R, N, U, L, PL II, W5Re/W26Re), heating control/cooling control/heating-cooling control, sampling cycle: 500 ms/4 channels, channel isolated, 18-point terminal block
		Q64TCTTBWN	4 channels, thermocouple (K, J, T, B, S, E, R, N, U, L, PL II, W5Re/W26Re), heating control/cooling control/heating-cooling control, heater disconnection detection function, sampling cycle: 500 ms/4 channels, channel isolated, two 18-point terminal blocks
	RTD	Q64TCRTN	4 channels, platinum RTD (Pt100, JPt100), heating control/cooling control/heating-cooling control, sampling cycle: 500 ms/4 channels, channel isolated, 18-point terminal block
		Q64TCRTBWN	4 channels, platinum RTD (Pt100, JPt100), heating control/cooling control/heating-cooling control, heater disconnection detection function, sampling cycle: 500 ms/4 channels, channel isolated, two 18-point terminal blocks
Loop control	Q62HLC	2 channels, input: thermocouple/micro voltage/voltage/current, conversion speed (input): 25 ms/2 channels, sampling cycle: 25 ms/2 channels, output: 4...20 mA DC, conversion speed (output): 25 ms/2 channels, 18-point terminal block, with 5 PID control modes	

*1: A connector is not provided. The A6CON4 connector must be ordered separately.

*2: Depending on the combination of power source module and base unit, the installable slot position may be limited.



Positioning and pulse I/O module

Type		Model	Outline
Simple motion	With SSCNET III/H connectivity	QD77MS2*1	2-axes, 2-axis linear interpolation, 2-axis circular interpolation, control unit: mm, inch, degree, pulse, no. of positioning data: 600/axis, 40-pin connector, with SSCNET III/H connectivity
		QD77MS4*1	4-axes, 2-/3-/4-axis linear interpolation, 2-axis circular interpolation, control unit: mm, inch, degree, pulse, no. of positioning data: 600/axis, 40-pin connector, with SSCNET III/H connectivity
		QD77MS16*1	16-axes, 2-/3-/4-axis linear interpolation, 2-axis circular interpolation, control unit: mm, inch, degree, pulse, no. of positioning data: 600/axis, 40-pin connector, with SSCNET III/H connectivity
	With CC-Link IE Field Network connectivity	QD77GF16*2	16-axes, 2-/3-/4-axis linear interpolation, 2-axis circular interpolation, control unit: mm, inch, degree, pulse, no. of positioning data: 600/axis, 26-pin connector, with CC-Link IE Field Network connectivity
Positioning	Open collector output	QD75P1N*1	1-axis, control unit: mm, inch, degree, pulse, no. of positioning data: 600/axis, max. output pulse: 200 kpps, 40-pin connector
		QD75P1*1	1-axis, control unit: mm, inch, degree, pulse, no. of positioning data: 600/axis, max. output pulse: 200 kpps, 40-pin connector
		QD75P2N*1	2-axes, 2-axis linear interpolation, 2-axis circular interpolation, control unit: mm, inch, degree, pulse, no. of positioning data: 600/axis, max. output pulse: 200 kpps, 40-pin connector
		QD75P2*1	2-axes, 2-axis linear interpolation, 2-axis circular interpolation, control unit: mm, inch, degree, pulse, no. of positioning data: 600/axis, max. output pulse: 200 kpps, 40-pin connector
		QD75P4N*1	4-axes, 2-/3-/4-axis linear interpolation, 2-axis circular interpolation, control unit: mm, inch, degree, pulse, no. of positioning data: 600/axis, max. output pulse: 200 kpps, 40-pin connector
		QD75P4*1	4-axes, 2-/3-/4-axis linear interpolation, 2-axis circular interpolation, control unit: mm, inch, degree, pulse, no. of positioning data: 600/axis, max. output pulse: 200 kpps, 40-pin connector
		QD70P4*1	4-axes, control unit: pulse, no. of positioning data: 10/axis, max. output pulse: 200 kpps, 40-pin connector
		QD70P8*1	8-axes, control unit: pulse, no. of positioning data: 10/axis, max. output pulse: 200 kpps, 40-pin connector
	Differential output	QD75D1N*1	1-axis, control unit: mm, inch, degree, pulse, no. of positioning data: 600/axis, max. output pulse: 4 Mpps, 40-pin connector
		QD75D1*1	1-axis, control unit: mm, inch, degree, pulse, no. of positioning data: 600/axis, max. output pulse: 1 Mpps, 40-pin connector
		QD75D2N*1	2-axes, 2-axis linear interpolation, 2-axis circular interpolation, control unit: mm, inch, degree, pulse, no. of positioning data: 600/axis, max. output pulse: 4 Mpps, 40-pin connector
		QD75D2*1	2-axes, 2-axis linear interpolation, 2-axis circular interpolation, control unit: mm, inch, degree, pulse, no. of positioning data: 600/axis, max. output pulse: 1 Mpps, 40-pin connector
		QD75D4N*1	4-axes, 2-/3-/4-axis linear interpolation, 2-axis circular interpolation, control unit: mm, inch, degree, pulse, no. of positioning data: 600/axis, max. output pulse: 4 Mpps, 40-pin connector
		QD75D4*1	4-axes, 2-/3-/4-axis linear interpolation, 2-axis circular interpolation, control unit: mm, inch, degree, pulse, no. of positioning data: 600/axis, max. output pulse: 1 Mpps, 40-pin connector
		QD70D4*1	4-axes, control unit: pulse, no. of positioning data: 10/axis, max. output pulse: 4 Mpps, 40-pin connector
		QD70D8*1	8-axes, control unit: pulse, no. of positioning data: 10/axis, max. output pulse: 4 Mpps, 40-pin connector
	With SSCNET connectivity	QD75M1*3	1-axis, control unit: mm, inch, degree, pulse, no. of positioning data: 600/axis, 40-pin connector, with SSCNET connectivity
		QD75M2*3	2-axes, 2-axis linear interpolation, 2-axis circular interpolation, control unit: mm, inch, degree, pulse, no. of positioning data: 600/axis, 40-pin connector, with SSCNET connectivity
		QD75M4*3	4-axes, 2-/3-/4-axis linear interpolation, 2-axis circular interpolation, control unit: mm, inch, degree, pulse, no. of positioning data: 600/axis, 40-pin connector, with SSCNET connectivity
		With SSCNET III connectivity	QD75MH1*3
	QD75MH2*3		2-axes, 2-axis linear interpolation, 2-axis circular interpolation, control unit: mm, inch, degree, pulse, no. of positioning data: 600/axis, 40-pin connector, with SSCNET III connectivity
	QD75MH4*3		4-axes, 2-/3-/4-axis linear interpolation, 2-axis circular interpolation, control unit: mm, inch, degree, pulse, no. of positioning data: 600/axis, 40-pin connector, with SSCNET III connectivity
	QD74MH8		8-axes, control unit: pulse, no. of positioning data: 32/axis, with SSCNET III connectivity
	Open collector output with built-in counter function	QD74MH16	16-axes, control unit: pulse, no. of positioning data: 32/axis, with SSCNET III connectivity
		QD72P3C3*1	Positioning: 3-axes, control unit: pulse, no. of positioning data: 1/axis, max. output pulse: 100 kpps, counter: 3 channels, 100 kpps, count input signal: 5/24 V DC, 40-pin connector
	High-speed counter	QD62*3	2 channels, 200/100/10 kpps, count input signal: 5/12/24 V DC, external input: 5/12/24 V DC, coincidence output: transistor (sink), 12/24 V DC, 0.5 A/point, 2 A/common, 40-pin connector
		QD62E*3	2 channels, 200/100/10 kpps, count input signal: 5/12/24 V DC, external input: 5/12/24 V DC, coincidence output: transistor (source), 12/24 V DC, 0.1 A/point, 0.4 A/common, 40-pin connector
QD62D*3		2 channels, 500/200/100/10 kpps, count input signal: EIA standards RS-422-A (differential line driver), external input: 5/12/24 V DC; coincidence output: transistor (sink), 12/24 V DC, 0.5 A/point, 2 A/common, 40-pin connector	
QD63P6*1		6 channels, 200/100/10 kpps, count input signal: 5 V DC, 40-pin connector	
QD64D2*1		2 channels, 4 Mpps, count input signal: EIA standards RS-422-A (differential line driver), external input: 24 V DC, coincidence output: transistor (sink), 12/24 V DC, 0.5 A/point, 2 A/common, 40-pin connector	
QD65PD2*1		2 Channels Differential input: 40 kpps/400 kpps/800 kpps/2 Mpps/4 Mpps/8 Mpps » Count input signal level: EIA Standards RS-422-A, differential line driver level DC Input: 10 kpps/100 kpps/200 kpps » Count input signal level: 5/12/24 V DC, 7...10 mA external outputs: Transistor (sink type) output, 12/24 V DC 0.1 A/point, 0.8 A/common, 40-pin connector	
Channel isolated pulse input	QD60P8-G	8 channels, 30 kpps/10 kpps/1 kpps/100 pps/50 pps/10 pps/1 pps/0.1 pps, count input signal: 5/12...24 V DC	

*1: A connector is not provided. The A6CON1/A6CON2/A6CON4 connector must be ordered separately.
 *2: A connector is not provided. The LD77MHIOCON connector must be ordered separately.
 *3: A connector is not provided. The A6CON1/A6CON2/A6CON3/A6CON4 connector must be ordered separately.

Energy measuring module

Type	Model	Outline
Energy measuring	QE81WH* ¹	Three-phase 3-wire type, Number of measurement circuits: 1 circuit, Measured items: power rate (consumption, regenerative), current, voltage, power, power factor, etc.
	QE84WH* ¹⁺²	Three-phase 3-wire type, Number of measurement circuits: 4 circuits, Measured items: power rate (consumption, regenerative), current, voltage, power, power factor, etc.
	QE81WH4W* ¹⁺³	Three-phase 4-wire type, Number of measurement circuits: 1 circuit, Measured items: power rate (consumption, regenerative), current, voltage, power, power factor, etc.
	QE83WH4W* ¹⁺²⁺³	Three-phase 4-wire type, Number of measurement circuits: 3 circuits, Measured items: power rate (consumption, regenerative), current, voltage, power, power factor, etc.
Option	QE8WH4VT	QE81WH4W, QE83WH4W dedicated voltage transformer (63.5/110 V AC...227/480 V AC)
Isolation monitoring	QE82LG* ⁴	Measured items: leakage current (Io), resistive component leakage current (Ior), number of measured circuits: 2 circuits

*1: Dedicated current sensors are required for operation.

*2: Current measurement mode is provided. Up to eight circuits can be measured when measuring only the current value.

*3: The separate voltage transformer (QE8WH4VT) is required for the three-phase 4-wire compatible products.

*4: Dedicated residual current transformers are required for operation.

Information module

MES interface	Option	QJ71MES96	MES interface module (MX MES interface and CompactFlash card are required)
		GT05-MEM-128MC	CompactFlash card, capacity: 128 MB
		GT05-MEM-256MC	CompactFlash card, capacity: 256 MB
		QD81MEM-512MBC	CompactFlash card, capacity: 512 MB
		QD81MEM-1GBC	CompactFlash card, capacity: 1 GB
High-speed data logger		QD81DL96	High-speed data logger module 10BASE-T/100BASE-TX (CompactFlash card is required)
High-speed data communication	Option	QD81MEM-512MBC	CompactFlash card, capacity: 512 MB
		QD81MEM-1GBC	CompactFlash card, capacity: 1 GB
		QD81MEM-2GBC	CompactFlash card, capacity: 2 GB
		QD81MEM-4GBC	CompactFlash card, capacity: 4 GB
		QD81MEM-8GBC	CompactFlash card, capacity: 8 GB
Ethernet		QJ71E71-100	10BASE-T/100BASE-TX BACnet™ client function, MODBUS® TCP master function (using predefined protocol support function)
		QJ71E71-B2	10BASE2
		QJ71E71-B5	10BASE5
Serial communication		QJ71C24N	RS-232: 1 channel, RS-422/485: 1 channel, total transmission speed of 2 channels: 230.4 kbps MODBUS® RTU master function (using predefined protocol support function)
		QJ71C24N-R2	RS-232: 2 channels, total transmission speed of 2 channels: 230.4 kbps MODBUS® RTU master function (using predefined protocol support function)
		QJ71C24N-R4	RS-422/485: 2 channels, total transmission speed of 2 channels: 230.4 kbps MODBUS® RTU master function (using predefined protocol support function)
Intelligent communication		QD51	BASIC program execution module, RS-232: 2 channels
		QD51-R24	BASIC program execution module, RS-232: 1 channel, RS-422/485: 1 channel
		SW1IVD-AD51HP* ⁵	Software package for QD51, AD51H-S3, and A1SD51S

*5: The program is run in Windows® command prompt.



Control network module

Type	Model	Outline	
CC-Link IE Control Network	QJ71GP21-SX	Multi-mode fiber optic cable, dual loop, control network (control/normal station)	
	QJ71GP21S-SX	Multi-mode fiber optic cable, dual loop, control network (control/normal station), with external power supply function	
MELSECNET/H	Optical loop (SI)	QJ71LP21-25	SI/QSI/H-PCF/broadband H-PCF fiber optic cable, dual loop, control network (control/normal station) or remote I/O network (remote mater station)
		QJ71LP21S-25	SI/QSI/H-PCF/broadband H-PCF fiber optic cable, dual loop, control network (control/normal station) or remote I/O network (remote mater station), with external power supply function
		QJ72LP25-25	SI/QSI/H-PCF/broadband H-PCF fiber optic cable, dual loop, remote I/O network (remote I/O station)
	Optical loop (GI)	QJ71LP21G	GI-50/125 fiber optic cable, dual loop, control network (control/normal station) or remote I/O network (remote master station)
		QJ72LP25G	GI-50/125 fiber optic cable, dual loop, remote I/O network (remote I/O station)
	Coaxial bus	QJ71BR11	3C-2V/5C-2V coaxial cable, single bus, control network (control/normal station) or remote I/O network (remote master station)
QJ72BR15		3C-2V/5C-2V coaxial cable, single bus, remote I/O network (remote I/O station)	
Twist bus	QJ71NT11B	Twisted pair cable, single bus, control network (control/normal station)	
CC-Link IE Field Network	QJ71GF11-T2	Master/local station, CC-Link IE Field Network compatible	
CC-Link	QJ61BT11N	Master/local station, CC-Link Ver. 2 compatible	
CC-Link/LT	QJ61CL12	Master station	
FL-net (OPCN-2)	Ver. 2.00	QJ71FL71-T-F01	10BASE-T, 100BASE-TX
		QJ71FL71-B2-F01	10BASE2
		QJ71FL71-B5-F01	10BASE5
	Ver. 1.00	QJ71FL71-T	10BASE-T
		QJ71FL71-B2	10BASE2
QJ71FL71-B5	10BASE5		
MODBUS®	QJ71MB91	MODBUS® RTU/ASCII, RS-232, RS-422/485 configurable as master or slave	
	QJ71MT91	MODBUS®/TCP 10BASE-T/100BASE-TX configurable as master or slave	
AS-i	QJ71AS92	Master station, AS-Interface Specification Version 2.11 compatible	

Digital link sensor

AnyWireASLINK	QJ51AW12AL DB	AnyWireASLINK master module
---------------	---------------	-----------------------------

Compatible module for each protocol

Compatible protocol	Compatible modules	Model	Outline
SLMP (MC protocol)	High-speed Universal model (Built-in Ethernet)	QnUDVCPU	SLMP server function (only MC protocol QnA compatible 3E frame)
	Universal model QCPU (Built-in Ethernet)	QnUDE(H)CPU	SLMP client function (using predefined protocol support function)
	Ethernet interface module	QJ71E71-100	SLMP server function (including MC protocol) SLMP client function (using predefined protocol support function)
BACnet™	High-speed Universal model (Built-in Ethernet)	QnUDVCPU	Compatible BACnet™ object: Analog Input (AI), Binary Input (BI), Binary Output (BO), Accumulator (AC) (using predefined protocol support function)
	Ethernet interface module	QJ71E71-100	Compatible BACnet™ object: Analog Input (AI), Analog Output (AO), Analog Value (AV), Binary Input (BI), Binary Output (BO), Binary Value (BV), Multi-state Input (MI), Multi-state Output (MO), Multi-state Value (MV), Accumulator (AC), Calendar (CA), EventEnrollment (EE), Group Object (GR), Notification Class (NC), Schedule (SC), TrendLog (TL), Device (DV), Measurement object (measure)*1, Power demand monitoring (monitor power)*2, Power demand control (control power)*2, Generator load control (generator)*2
	BACnet™ interface module (3rd party products)	BAQ08V	
MODBUS®/TCP	High-speed Universal model (Built-in Ethernet)	QnUDVCPU	MODBUS®/TCP communication master function (using predefined protocol support function)
	Ethernet interface module	QJ71E71-100	
	MODBUS®/TCP interface module	QJ71MT91	MODBUS®/TCP communication master function/slave function
MODBUS®	Serial communication module	QJ71C24N (-R2/R4)	MODBUS®RTU communication master function (using predefined protocol support function)
	MODBUS® interface module	QJ71MB91	MODBUS® RTU/ASCII communication master function/slave function

*1: ANSI/ASHRAE 2004 and IEC 60335-1 standards are not supported.
*2: ANSI/ASHRAE 2004 standard is not supported.

Replacement support MELSEC-A/AnS/QnA/QnAS transition products

Type		Model	Outline
Q Large base	Main base	Q35BL* ¹	5 slots. Power supply module installation required. For Q Series large input/output module installation
		Q38BL* ¹	8 slots. Power supply module installation required. For Q Series large input/output module installation
	Extension base	Q65BL* ¹	5 slots. Power supply module installation required. For Q Series large input/output module installation
		Q68BL* ¹	8 slots. Power supply module installation required. For Q Series large input/output module installation
	Large blank cover	Q55BL* ¹	5 slots. Power supply module installation not required. For Q Series large input/output module installation
		QG69L* ¹	For gap adjustment when a previous Q Series module is installed on the Q large base
AnS-sized version Q Large base	Main base	Q35BLS	5 slots. Q Series module installation Attaches to board surface
		Q38BLS	8 slots. Q Series module installation Attaches to board surface
		Q35BLS-D	5 slots. Q Series module installation Attaches to DIN rail
		Q38BLS-D	8 slots. Q Series module installation Attaches to DIN rail
	Extension base	Q65BLS	5 slots. Q Series module installation Attaches to board surface
		Q68BLS	8 slots. Q Series module installation Attaches to board surface
		Q65BLS-D	5 slots. Q Series module installation Attaches to DIN rail
		Q68BLS-D	8 slots. Q Series module installation Attaches to DIN rail
		Q55BLS	5 slots. Q Series module installation Attaches to board surface, power supply module not required
			Q55BLS-D
Large blank cover	QG69LS	Use to adjust the gap when an existing Q Series unit is installed on the large base unit of the AnS-sized Q.	
Q Large I/O	Input	QX11L* ¹	For replacement of A-Series large type module "AX11". 32 points, 100...120 V AC, response time: 25 ms, 32 points/common, 38-point terminal block
		QX21L* ¹	For replacement of A-Series large type module "AX21". 32 points, 200...240 V AC, response time: 25 ms, 32 points/common, 38-point terminal block
	Output	QY11AL* ¹	For replacement of A-Series large type module "AY10A, AY11A". 16 points, contact, 24 V DC/240 V AC, 2 A/point; 16 A/all points, all-point independent contacts, response time: 12 ms, 38-point terminal block
		QY13L* ¹	For replacement of A-Series large type module "AY13". 32 points, contact, 24 V DC/240 V AC, 2 A/point; 5 A/common, 8 points/common, response time: 12 ms, 38-point terminal block
		QY23L* ¹	For replacement of A-Series large type module "AY23". 32 points, triac, 100...240 V AC; 0.6 A/point, 2.4 A/common, 8 points/common, response time: 1 ms + 0.5 cycle, 38-point terminal block
		QY51PL	For replacement of A-Series large type module "AY41, AY41P, AY51, AY51-S1". 32 points, transistor (sink), 12/24 V DC; 0.5 A/point; 4 A/common, 16 points/common, response time: 1 ms, 38-point terminal block
High-speed counter		QD62-H01* ²	For replacement of A-Series large type module "AD61". 2 channels, 50 kpps, count input signal: 5/12/24 V DC, external input: 5/12/24 V DC, coincidence output: transistor (sync), 12/24 V DC, 0.5 A/point; 2 A/common
		QD62-H02* ²	For replacement of A-Series large type module "AD61-S1". 2 channels, 10 kpps, count input signal: 5/12/24 V DC, external input: 5/12/24 V DC, coincidence output: transistor (sync), 12/24 V DC, 0.5 A/point; 2 A/common
Positioning		QD73A1	For replacement of "A1SD70". 1 axis. Number of positioning data items: 1 data/axis, analog output
Extension base	AnS Series	QA1S51B* ³	1 slot. Does not require installation of AnS Series power supply module. For AnS Series module installation
		QA1S65B* ³	5 slots. Requires AnS Series power supply module installation. For AnS Series module installation
		QA1S68B* ³	8 slots. Requires AnS Series power supply module installation. For AnS Series module installation
	A Series	QA65B* ³	5 slots. Requires A Series power supply module installation. For A Series module installation
		QA68B* ³	8 slots. Requires A Series power supply module installation. For A Series module installation
Q-AnS base unit conversion adapter		QA1S6ADP	Conversion adapter to connect an AnS/QnAS Series extension base unit to the Q Series system
		QA1S6ADP-S1	Conversion adapter to connect an AnS/QnAS Series extension base unit to the Q Series system (for up to 3 extension base units)
QA base unit conversion adapter		QA6ADP	Conversion adapter to connect an A/QnA Series extension base unit to the Q Series system
For MELSECNET (II) local station		A1SJ71AP23Q* ⁴	Optic cable, duplex loop, MELSECNET (II) local station
		A1SJ71AR23Q* ⁴	3C-2V/5C-2V coaxial cable, duplex loop, MELSECNET (II) local station
For MELSECNET/B local station		A1SJ71AT23BQ* ⁴	Twisted pair cable, single bus, MELSECNET/B local station

*1: Only supported only by High Performance QCPU and Universal QCPU (Excluding Q00JCPU).

*2: A connector is not provided. Please order one of the following separately: A6CON1/A6CON2/A6CON3/A6CON4

*3: Only supported only by High Performance model QCPU.

*4: Only supported by high performance model QCPU and Universal model QCPU (first five digits of serial No. 13102 or higher).



Network interface board

Type		Model	Outline
CC-Link IE Control Network		Q80BD-J71GP21-SX	PCI bus/PCI-X bus, Japanese/English OS compatible, multi-mode fiber optic cable, dual loop, control network (control/normal station)
		Q81BD-J71GP21-SX	PCI Express bus, Japanese/English OS compatible, multi-mode fiber optic cable, dual loop, control network (control/normal station)
		Q80BD-J71GP21S-SX	PCI bus/PCI-X bus, Japanese/English OS compatible, multi-mode fiber optic cable, dual loop, control network (control/normal station), with external power supply function
		Q81BD-J71GP21S-SX	PCI Express bus, Japanese/English OS compatible, multi-mode fiber optic cable, dual loop, control network (control/normal station), with external power supply function
CC-Link IE Field Network		Q81BD-J71GF11-T2*1	PCI Express compatible, Ethernet connections in line, star, or line and star mixed, configurable as master or local station.
MELSECNET/H(10)	Optical loop (SI)	Q81BD-J71LP21-25	PCI Express bus, Japanese/English OS compatible, SI/QSI/H-PCF/broadband H-PCF fiber optic cable, dual loop, control network (control/normal station)
		Q80BD-J71LP21-25	PCI bus, Japanese/English OS compatible, SI/QSI/H-PCF/broadband H-PCF fiber optic cable, dual loop, control network (control/normal station)
		Q80BD-J71LP21S-25	PCI bus, Japanese/English OS compatible, SI/QSI/H-PCF/broadband H-PCF fiber optic cable, dual loop, control network (control/normal station), with external power supply function
	Optical loop (GI)	Q80BD-J71LP21G	PCI bus, Japanese/English OS compatible, GI-50/125 fiber optic cable, dual loop, control network (control/normal station)
	Coaxial bus	Q80BD-J71BR11	PCI bus, Japanese/English OS compatible, 3C-2V/5C-2V coaxial cable, single bus, control network (control/normal station)
CC-Link		Q81BD-J61BT11	PCI Express bus, Japanese/English OS compatible, master/local interface board, CC-Link Ver. 2 compatible
		Q80BD-J61BT11N	PCI bus, Japanese/English OS compatible, master/local interface board, CC-Link Ver. 2 compatible

*1: Does not support being used as the master station in a ring network.

Ethernet related products

Wireless LAN Adapter	U.S.A.	NZ2WL-US*2*3 DB	Conforms to IEEE 802.11a, IEEE 802.11b, IEEE 802.11g standards
	Europe	NZ2WL-EU*2*3 DB	Conforms to IEEE 802.11a, IEEE 802.11b, IEEE 802.11g standards
	China	NZ2WL-CN*2*3 DB	Conforms to IEEE 802.11a, IEEE 802.11b, IEEE 802.11g standards
	Korea	NZ2WL-KR*2*3 DB	Conforms to IEEE 802.11a, IEEE 802.11b, IEEE 802.11g standards
	Taiwan	NZ2WL-TW*2*3 DB	Conforms to IEEE 802.11a, IEEE 802.11b, IEEE 802.11g standards
Industrial switching HUB		NZ2EHG-T8 DB	10 Mbps/100 Mbps/1 Gbps AUTO-MDIX, DIN rail supported, 8 ports
		NZ2EHF-T8 DB	10 Mbps/100 Mbps AUTO-MDIX, DIN rail supported, 8 ports
CC-Link IE Field Network Ethernet Adapter		NZ2GF-ETB	100 Mbps/1 Gbps compatible station for expanding CC-Link IE Field Networks

*2: Each product is usable only in the respective country.

*3: Both access points and stations are supported, and can be switched with the settings.

»For details on the software versions compatible with each module, refer to the manual for each product.
Please contact your local Mitsubishi Electric sales office or representative for the latest information about MELSOFT software versions and compatible operating systems.

Software MELSOFT GX Series

* Refer to the "Compatible CPUs" table for individual model names.

Type	Model	Outline	Compatible CPU*						
			Universal model			High Performance model	Basic model	Process CPU	Redundant CPU
			QnUDV	QnU	QnUD(E)				
MELSOFT GX Works3	SW1DND-GXW3-E	Controller Programming Software: MELSOFT GX Works3 ^{*1} MITSUBISHI ELECTRIC FA Library Comes with GX Works2 and GX Developer	Supported by GX Works2 or GX Developer (both come with GX Works3)						
MELSOFT GX Works2	SW1DNC-GXW2-E	Controller Programming Software Comes with GX Developer	●	●	●	●	●	●	●
MELSOFT GX Developer	SW8D5C-GPPW-E	MELSEC programmable controller programming software	—	●	● ^{*2}	●	●	●	●
	SW8D5C-GPPW-EV	MELSEC programmable controller programming software (upgrade)	—	●	● ^{*2}	●	●	●	●
MELSOFT GX Simulator ^{*4}	SW7D5C-LLT-E	MELSEC programmable controller simulation software	—	●	● ^{*2}	●	●	●	●
	SW7D5C-LLT-EV	MELSEC programmable controller simulation software (upgrade)	—	●	● ^{*2}	●	●	●	●
MELSOFT GX Converter ^{*4}	SW0D5C-CNVW-E	Excel®/text data converter	—	—	—	●	●	●	●
MELSOFT GX Configurator-AD ^{*4}	SW2D5C-QADU-E	Analog to digital conversion module setting/monitoring tool	—	●	● ^{*2}	●	●	●	●
MELSOFT GX Configurator-DA ^{*4}	SW2D5C-QDAU-E	Digital to analog conversion module setting/monitoring tool	—	●	● ^{*2}	●	●	●	●
MELSOFT GX Configurator-SC ^{*4}	SW2D5C-QSCU-E	MELSEC-Q dedicated serial communication module setting/monitoring tool	—	●	● ^{*2}	●	●	●	●
MELSOFT GX Configurator-CT ^{*4}	SW0D5C-QCTU-E	MELSEC-Q dedicated high-speed counter module setting/monitoring tool	—	●	● ^{*2}	●	●	●	●
MELSOFT GX Configurator-TC ^{*4}	SW0D5C-QTCU-E	MELSEC-Q dedicated temperature control module setting/monitoring tool	—	●	● ^{*2}	●	●	●	●
MELSOFT GX Configurator-TI ^{*4}	SW1D5C-QTIU-E	MELSEC-Q dedicated temperature input module setting/monitoring tool	—	●	● ^{*2}	●	●	●	●
MELSOFT GX Configurator-FL ^{*4}	SW0D5C-QFLU-E	MELSEC-Q dedicated FL-net module setting/monitoring tool	—	●	● ^{*2}	●	●	●	●
MELSOFT GX Configurator-PT ^{*4}	SW1D5C-QPTU-E	MELSEC-Q dedicated positioning module QD70 setting/monitoring tool	—	●	● ^{*2}	●	●	●	●
MELSOFT GX Configurator-MB ^{*4}	SW1D5C-QMBU-E	MODBUS master module setting/monitoring tool	—	●	● ^{*2}	●	●	●	●
MELSOFT GX Configurator-AS ^{*4}	SW1D5C-QASU-E	AS-i master module setting/monitoring tool	—	●	● ^{*2}	●	●	●	●
MELSOFT GX Configurator-QP	SW2D5C-QD75P-E	Positioning module QD75P/D/M setting/monitoring tool	—	●	● ^{*2}	●	●	●	●
MELSOFT GX Explorer	SW2D5C-EXP-E	Maintenance tool	—	—	—	●	●	● ^{*3}	—
MELSOFT GX RemoteService- I	SW2D5C-RAS-E	Remote access tool	—	—	—	●	●	● ^{*3}	—
MELSOFT GX Works	SW4D5C-QSET-E	Set type products (7 in total): GX Developer, GX Simulator, GX Explorer, GX Configurator-AD, DA, SC, CT	*5						
	SW8D5C-GPPLT-E	GX Developer, GX Simulator, GX Explorer	*5						

*1: The MELSOFT GX Works3 menu is switchable between Japanese, English, and simplified Chinese. (Traditional Chinese and Korean will be supported soon.)

*2: Not compatible with Q50UDEHCPU, Q100UDEHCPU, and QJ71GF11-T2.

*3: Not compatible with Q02PHCPU and Q06PHCPU.

*4: This operates as add-in software for GX Developer. GX Developer is required separately.

*5: To determine which CPUs are supported, refer to the individual products above.



Software MELSOFT PX Series

* Refer to the "Compatible CPUs" table for individual model names.

Type	Model	Outline	Compatible CPU*						
			Universal model			High Performance model	Basic model	Process CPU	Redundant CPU
			QnUDV	QnU	QnUD(E)				
MELSOFT PX Developer	SW1D5C-FBDQ-E	Process control FBD software package	—	—	—	—	—	●	●
	SW1DNC-FBDQMON-E	Process control FBD software package monitoring tool	—	—	—	—	—	●	●
MELSOFT PX Works	SW3D5C-FBDGPP-E	Set type products (6 in total): PX Developer, GX Developer, GX Configurator-AD, DA, CT, TI	*1						

*1: To determine which CPUs are supported, refer to the individual products.

Software MELSOFT MX Series

Type	Model	Outline	●	●	●	●	●	●	●
MELSOFT MX Component	SW4DNC-ACT-E	ActiveX® library for communication	●	●	●	●	●	●	●
MELSOFT MX Sheet	SW2DNC-SHEET-E*2	Excel® communication support tool	●	●	●	●	●	●	●
MELSOFT MX Works	SW2DNC-SHEETSET-E	A set of two products: MX Component, MX Sheet	*3						
MELSOFT MX MES Interface	SW1DNC-MESIF-E	MES interface module QJ71MES96 dedicated information linkage tool	*4						

*2: To use MX Sheet, MX Component is required.

*3: To determine which CPUs are supported, refer to the individual products.

*4: Required when using the MES interface module.

Software MELSOFT iQ Works

MELSOFT iQ Works	SW2DND-IQWK-E	FA engineering software*5 • System Management Software: MELSOFT Navigator • Controller Programming Software: MELSOFT GX Works3*6, GX Works2, GX Developer • Motion Programming Software: MELSOFT MT Works2 • HMI Programming Software: MELSOFT GT Works3 • Robot Programming Software: MELSOFT RT ToolBox2 mini • Inverter Setup Software: MELSOFT FR Configurator2 • MITSUBISHI ELECTRIC FA Library
------------------	---------------	---

*5: For detailed information about supported modules, refer to the manuals of the relevant software package.

*6: The MELSOFT GX Works3 menu is switchable between Japanese, English, and simplified Chinese. (Traditional Chinese and Korean will be supported soon.)

Compatible CPUs

Item	Model
Universal model QCPU	QnUDV Q03UDV, Q04UDV, Q06UDV, Q13UDV, Q26UDV
	QnU Q00UJ, Q00U, Q01U, Q02U
	QnUD(E) Q03UD(E), Q04UD(E)H, Q06UD(E)H, Q10UD(E)H, Q13UD(E)H, Q20UD(E)H, Q26UD(E)H, Q50UDEH, Q100UDEH
High Performance model QCPU	Q02, Q02H, Q06H, Q12H, Q25H
Basic model QCPU	Q00J, Q00, Q01
Process CPU	Q02PH, Q06PH, Q12PH, Q25PH
Redundant CPU	Q12PRH, Q25PRH

FA Products

HMI

Graphic Operation Terminal GOT2000 Series GT27 Model



To the top of HMIs with further user-friendly, satisfactory standard features.

- ◎ Comfortable screen operation even if high-load processing (e.g. logging, device data transfer) is running. (Monitoring performance is twice faster than GT16)
- ◎ Actual usable space without using a SD card is expanded to 128MB for more flexible screen design.
- ◎ Multi-touch features, two-point press, and scroll operations for more user-friendliness.
- ◎ Outline font and PNG images for clear, beautiful screen display.

Product Specifications

Screen size	15", 12.1", 10.4", 8.4"
Resolution	XGA, SVGA, VGA
Intensity adjustment	32-step adjustment
Touch panel type	Analog resistive film
Built-in interface	RS-232, RS-422/485, Ethernet, USB, SD card
Applicable software	GT Works3
Input power supply voltage	100 to 240VAC (+10%, -15%), 24VDC (+25%, -20%)

Inverter

FR-A800 Series



High-functionality, high-performance inverter

- ◎ Realize even higher responsiveness during real sensor-less vector control or vector control, and achieve faster operating frequencies.
- ◎ The latest automatic tuning function supports various induction motors and also sensor-less PM motors.
- ◎ The standard model is compatible with EU Safety Standards STO (PLd, SIL2). Add options to support higher level safety standards.
- ◎ Control and monitor inverters via CC-Link/CC-Link IE Field Network (option interface).

Product Specifications

Inverter capacity	200V class: 0.4kW to 90kW, 400V class: 0.4kW to 500kW
Control method	High-carrier frequency PWM control (Select from V/F, advanced magnetic flux vector, real sensorless vector or PM sensorless vector control), vector control (when using options)
Output frequency range	0.2 to 590Hz (upper limit is 400Hz when using advanced magnetic flux vector control, real sensorless vector control, vector control or PM sensorless vector control)
Regenerative braking torque (Maximum allowable duty)	200V class: 0.4K to 1.5K (150% at 3%ED) 2.2K/3.7K (100% at 3%ED) 5.5K/7.5K (100% at 2%ED) 11K to 55K (20% continuous) 75K or more (10% continuous), 400V class: 0.4K to 7.5K (100% at 2%ED) 11K to 55K (20% continuous) 75K or more (10% continuous)
Starting torque	200% 0.3Hz (3.7K or less), 150% 0.3Hz (5.5K or more) (when using real sensorless vector, vector control)

AC Servo

Mitsubishi General-Purpose AC Servo MELSERVO-J4 Series



Industry-leading level of high performance servo

- ◎ Industry-leading level of basic performance: Speed frequency response (2.5kHz), 4,000,000 (4,194,304p/rev) encoder
- ◎ Advanced one-touch tuning function achieves the one-touch adjustment of advanced vibration suppression control II, etc.
- ◎ Equipped with large capacity drive recorder and machine diagnosis function for easy maintenance.
- ◎ 2-axis and 3-axis servo amplifiers are available for energy-conservative, space-saving, and low-cost machines.

Product Specifications

Power supply specifications	1-phase/3-phase 200V AC, 1-phase 100V AC, 3-phase 400V AC
Command interface	SSCNET III/H, SSCNET III (compatible in J3 compatibility mode), CC-Link IE Field Network interface with Motion, pulse train, analog
Control mode	Position/Speed/Torque/Positioning function/Fully closed loop
Speed frequency response	2.5kHz
Tuning function	Advanced one-touch tuning, advanced vibration suppression control II, robust filter, etc.
Functional safety	Conforms to functions of IEC/EN 61800-5-2, STO: Category 3 PL d, SIL 2 Conforms to Category 4 PL e, SIL 3 by a combination with MR-D30 functional safety unit
Compatible servo motor	Rotary servo motor (rated output: 0.05 to 55kW), linear servo motor (continuous thrust 50 to 3000N), direct drive motor (rated torque: 2 to 240N·m)

Magnetic Starter

MS-T Series



Exceed your expectations.

- 10A frame model is over 16% smaller with a width of just 36mm!!
- New integrated terminal covers.
- Reduce your coil inventory by up to 50%.
- Be certified to the highest international levels while work is ongoing to gain other country.

Product specifications

Frame	10 A to 32 A
Applicable standards	Certification to various standards including IEC, JIS, CE, UL, TÜV, CCC.
Terminal cover	Standard terminal cover improves safety, simplifies ordering, and reduces inventory, etc.
Improved wiring	Wiring and operability are improved with streamlining wiring terminal BC specifications.
Operation coil rating	Wide range of operation coil ratings reduces number of coil types from 14 (N Series) to 7 types and simplifies selection.
Option units	Diverse lineup includes Auxiliary Contact Block, Operation Coil Surge Absorber Unit, Mechanical Interlock Unit.

Low Voltage Circuit Breakers

Mitsubishi WS-V Series Molded Case Circuit Breakers, Earth Leakage Circuit Breakers

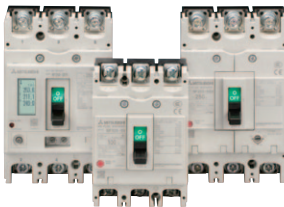

Technologies based on long year experience realize more improved performance.

- The new electronic circuit breakers can display various measurement items.
- Improvement of breaking performance with new breaking technology “Expanded ISTAC”.
- Compliance with global standard for panel and machine export.
- Commoditization of internal accessories for shorter delivery time and stock reduction.

Product Specifications.

Frame	32-250A Frame
Applicable standard	Applicable to IEC, GB, UL, CSA, JIS and etc.
Expansion of UL listed product line-up	New line-up of 480VAC type with high breaking performance for SCCR requirement
Commoditization of internal accessories	Reduction of internal accessory types from 3 to 1
Commoditization for AC and DC circuit use	Common use of 32/63A frame in both AC and DC circuit
Compact size for easy to use	Thermal adjustable and electronic circuit breakers are same size as 250AF fixed type
Measuring Display Unit (MDU) breakers	MDU breakers measure, display and transmit energy date to realize energy management.

Robot

MELFA F Series



High speed, high precision and high reliability industrial robot

- Compact body and slim arm design, allowing operating area to be expanded and load capacity increased.
- The fastest in its class using high performance motors and unique driver control technology.
- Improved flexibility for robot layout design considerations.
- Optimal motor control tuning set automatically based on operating position, posture, and load conditions.

Product Specifications

Degrees of freedom	Vertical:6 Horizontal:4
Installation	Vertical:Floor-mount, ceiling mount, wall mount (Range of motion for J1 is limited) Horizontal:Floor-mount
Maximum load capacity	Vertical:2-20kg Horizontal:3-20kg
Maximum reach radius	Vertical:504-1503mm Horizontal:350-1,000mm

iQ Platform compatible CNC to provide TCO reduction effect.

- ◎A CNC structured in building block method on iQ Platform.
- ◎High performance CNC integrated with high-speed PLC offers high-speed control to reduce cycle time.
- ◎A wide variety of FA products helps construct flexible lines.



Product specifications

Maximum number of control axes (NC axis + spindle + PLC axis)	16 axes
Maximum number of part system	Machining center system: 7 systems, Lathe system: 3 systems
Maximum number of NC axes per part system	8 axes
Maximum program capacity	2,000 KB (5,120 m)
Maximum number of files to store	124 files/252 files
Number of input/output points	4,096 points
Safety observation function	Safety signal comparison function, speed monitoring function, duplexed emergency stop

Microsoft, Windows, Excel, ActiveX are registered trademarks of Microsoft Corporation in the United States and other countries.
Ethernet is a registered trademark of Xerox Corporation.
SD/SDHC logo is a trademark of SD-3C, LLC.
VxWorks is a registered trademark of Wind River Systems, Inc. in the United States and other countries.
MODBUS is a registered trademark of Schneider Electric USA, Inc.
CompactFlash is a registered trademark of SanDisk Corporation.
BACnet is a registered trademark of ASHRAE.
Cognex, In-Sight, DataMan, VisionView and UltraLight are registered trademarks of Cognex Corporation.
Hotbars is a trademark of Cognex Corporation.
All other company names and product names used in this document are trademarks or registered trademarks of their respective companies.

Precautions before use

This publication explains the typical features and functions of the products herein and does not provide restrictions or other information related to usage and module combinations. Before using the products, always read the product user manuals. Mitsubishi Electric will not be held liable for damage caused by factors found not to be the cause of Mitsubishi Electric; opportunity loss or lost profits caused by faults in Mitsubishi Electric products; damage, secondary damage, or accident compensation, whether foreseeable or not, caused by special factors; damage to products other than Mitsubishi Electric products; or any other duties.

For safe use

- To use the products given in this publication properly, always read the relevant manuals before beginning operation.
- The products have been manufactured as general-purpose parts for general industries, and are not designed or manufactured to be incorporated in a device or system used in purposes related to human life.
- Before using the products for special purposes such as nuclear power, electric power, aerospace, medicine or passenger-carrying vehicles, consult with Mitsubishi Electric.
- The products have been manufactured under strict quality control. However, when installing the products where major accidents or losses could occur if the products fail, install appropriate backup or fail-safe functions in the system.

Country/Region	Sales office	Tel/Fax
USA	MITSUBISHI ELECTRIC AUTOMATION, INC. 500 Corporate Woods Parkway, Vernon Hills, IL 60061, U.S.A.	Tel : +1-847-478-2100 Fax : +1-847-478-2253
Mexico	MITSUBISHI ELECTRIC AUTOMATION, INC. Mexico Branch Mariano Escobedo #69, Col. Zona Industrial, Tlalnepantla Edo, C.P.54030, Mexico	Tel : +52-55-3067-7500
Brazil	MITSUBISHI ELECTRIC DO BRASIL COMÉRCIO E SERVIÇOS LTDA. Rua Jussara, 1750-Blcco B Anexo, Jardim Santa Cecilia, CEP 06465-070, Barueri-SP, Brasil	Tel : +55-11-4689-3000 Fax : +55-11-4689-3016
Germany	MITSUBISHI ELECTRIC EUROPE B.V. German Branch Gothaer Strasse 8, D-40880 Ratingen, Germany	Tel : +49-2102-486-0 Fax : +49-2102-486-1120
UK	MITSUBISHI ELECTRIC EUROPE B.V. UK Branch Travellers Lane, Hatfield, Hertfordshire, AL10 8XB, U.K.	Tel : +44-1707-28-8780 Fax : +44-1707-27-8695
Ireland	MITSUBISHI ELECTRIC EUROPE B.V. Irish Branch Westgate Business Park, Ballymount, IRL-Dublin 24, Ireland	Tel : +353-1-4198800 Fax : +353-1-4198890
Italy	MITSUBISHI ELECTRIC EUROPE B.V. Italian Branch Centro Direzionale Colleoni-Palazzo Sirio Viale Colleoni 7, 20864 Agrate Brianza(Milano) Italy	Tel : +39-039-60531 Fax : +39-039-6053-312
Spain	MITSUBISHI ELECTRIC EUROPE, B.V. Spanish Branch Carretera de Rubí, 76-80-Apdo. 420, 08173 Sant Cugat del Vallés (Barcelona), Spain	Tel : +34-935-65-3131 Fax : +34-935-89-1579
France	MITSUBISHI ELECTRIC EUROPE B.V. French Branch 25, Boulevard des Bouvets, F-92741 Nanterre Cedex, France	Tel : +33-1-55-68-55-68 Fax : +33-1-55-68-57-57
Czech Republic	MITSUBISHI ELECTRIC EUROPE B.V. Czech Branch Avenir Business Park, Radlicka 751/113e, 158 00 Praha5, Czech Republic	Tel : +420-251-551-470 Fax : +420-251-551-471
Poland	MITSUBISHI ELECTRIC EUROPE B.V. Polish Branch ul. Krakowska 50, 32-083 Balice, Poland	Tel : +48-12-630-47-00 Fax : +48-12-630-47-01
Sweden	MITSUBISHI ELECTRIC EUROPE B.V. (Scandinavia) Fjellievägen 8, SE-22736 Lund, Sweden	Tel : +46-8-625-10-00 Fax : +46-46-39-70-18
Russia	MITSUBISHI ELECTRIC EUROPE B.V. Russian Branch St. Petersburg office Piskarevsky pr. 2, bld 2, lit "Sch", BC "Benua", office 720; RU-195027 St. Petersburg, Russia	Tel : +7-812-633-3497 Fax : +7-812-633-3499
Turkey	MITSUBISHI ELECTRIC TURKEY A.Ş Ümraniye Branch Serifali Mahallesi Nutuk Sokak No:5, TR-34775 Umraniye, Istanbul, Turkey	Tel : +90-216-526-3990 Fax : +90-216-526-3995
Dubai	MITSUBISHI ELECTRIC EUROPE B.V. Dubai Branch Dubai Silicon Oasis, P.O.BOX 341241, Dubai, U.A.E.	Tel : +971-4-3724716 Fax : +971-4-3724721
South Africa	ADROIT TECHNOLOGIES 20 Waterford Office Park, 189 Witkoppen Road, Fourways, Johannesburg, South Africa	Tel : +27-11-658-8100 Fax : +27-11-658-8101
China	MITSUBISHI ELECTRIC AUTOMATION (CHINA) LTD. No.1386 Hongqiao Road, Mitsubishi Electric Automation Center, Shanghai, China	Tel : +86-21-2322-3030 Fax : +86-21-2322-3000
Taiwan	SETSUYO ENTERPRISE CO., LTD. 6F, No.105, Wugong 3rd Road, Wugu District, New Taipei City 24889, Taiwan, R.O.C.	Tel : +886-2-2299-2499 Fax : +886-2-2299-2509
Korea	MITSUBISHI ELECTRIC AUTOMATION KOREA CO., LTD. 7F-9F, Gangseo Hangang Xi-tower A, 401, Yangcheon-ro, Gangseo-Gu, Seoul 157-801, Korea	Tel : +82-2-3660-9530 Fax : +82-2-3664-8372
Singapore	MITSUBISHI ELECTRIC ASIA PTE. LTD. 307, Alexandra Road, Mitsubishi Electric Building, Singapore 159943	Tel : +65-6473-2308 Fax : +65-6476-7439
Thailand	MITSUBISHI ELECTRIC FACTORY AUTOMATION (THAILAND) CO., LTD. 12th Floor, SV.City Building, Office Tower 1, No. 896/19 and 20 Rama 3 Road, Kwaeng Bangpongpan, Khet Yannawa, Bangkok 10120, Thailand	Tel : +66-2682-6522 Fax : +66-2682-6020
Vietnam	MITSUBISHI ELECTRIC VIETNAM COMPANY LIMITED Hanoi Branch 6-Floor, Detech Tower, 8 Ton That Thuyet Street, My Dinh 2 Ward, Nam Tu Liem District, Hanoi, Vietnam	Tel : +84-4-3937-8075 Fax : +84-4-3937-8076
Indonesia	PT. MITSUBISHI ELECTRIC INDONESIA Gedung Jaya 11th Floor, JL. MH. Thamrin No.12, Jakarta Pusat 10340, Indonesia	Tel : +62-21-3192-6461 Fax : +62-21-3192-3942
India	MITSUBISHI ELECTRIC INDIA PVT. LTD. Pune Branch Emerald House, EL-3, J Block, M.I.D.C Bhosari, Pune-411026, Maharashtra, India	Tel : +91-20-2710-2000 Fax : +91-20-2710-2100
Australia	MITSUBISHI ELECTRIC AUSTRALIA PTY. LTD. 348 Victoria Road, P.O. Box 11, Rydalmere, N.S.W 2116, Australia	Tel : +61-2-9684-7777 Fax : +61-2-9684-7245

Mitsubishi Electric Corporation Nagoya Works is a factory certified for ISO 14001 (standards for environmental management systems) and ISO 9001 (standards for quality assurance management systems)

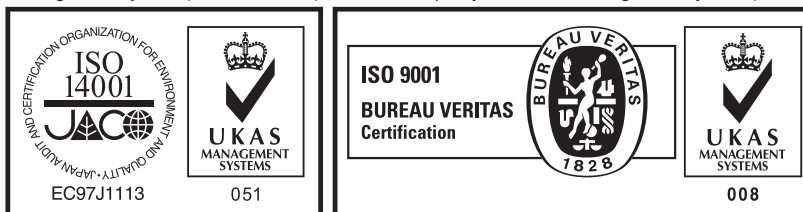

MITSUBISHI ELECTRIC CORPORATION

HEAD OFFICE: TOKYO BUILDING, 2-7-3, MARUNOUCHI, CHIYODA-KU, TOKYO 100-8310, JAPAN
NAGOYA WORKS: 1-14, YADA-MINAMI 5, HIGASHI-KU, NAGOYA, JAPAN