

# MSH-4MSH

Industrial Line

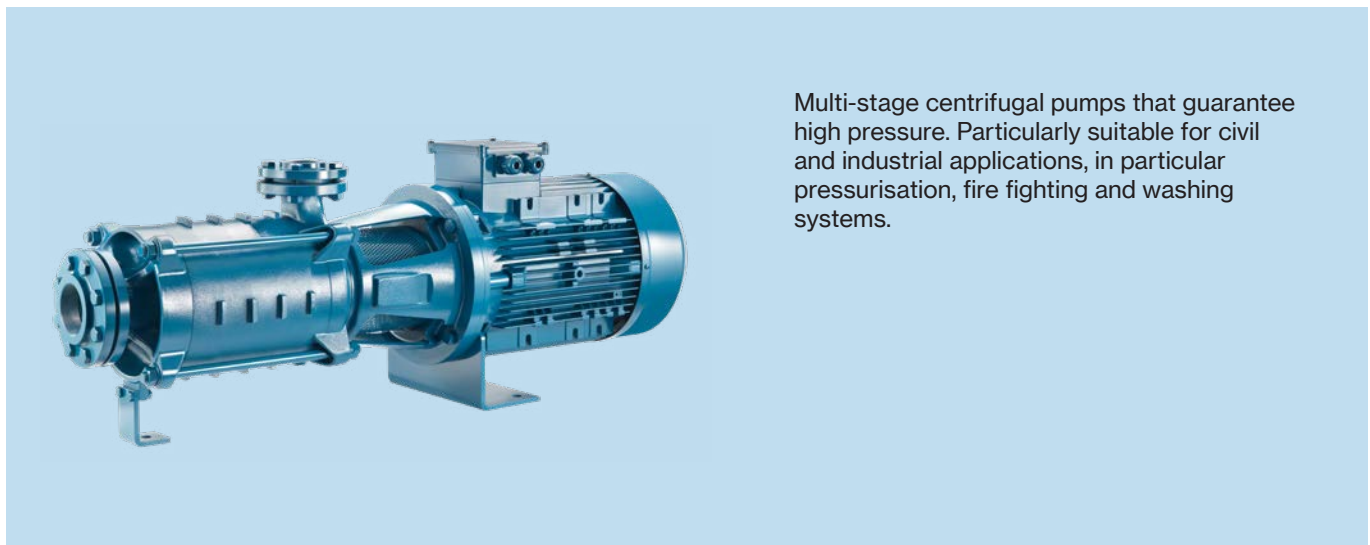

Multi-stage centrifugal pumps that guarantee high pressure. Particularly suitable for civil and industrial applications, in particular pressurisation, fire fighting and washing systems.

Construction features	
<b>Pump body</b>	cast iron
<b>Motor bracket</b>	cast iron
<b>Impeller</b>	brass
<b>Mechanical seal</b>	ceramic-graphite-NBR
<b>Shaft</b>	stainless steel AISI 304
<b>Liquid temperature</b>	-10 ÷ +90 °C
<b>Operating pressure</b>	max 30 bar

Motor	
<b>2 and 4 poles induction motor</b>	3~ 230/400V - 50Hz P ≤ 4kW 3~ 400/690V - 50Hz P > 4kW
<b>Insulation class</b>	F
<b>Protection degree</b>	IPX5

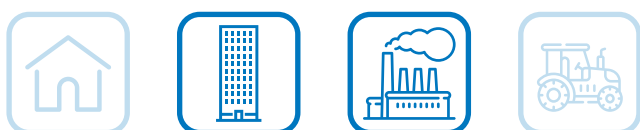
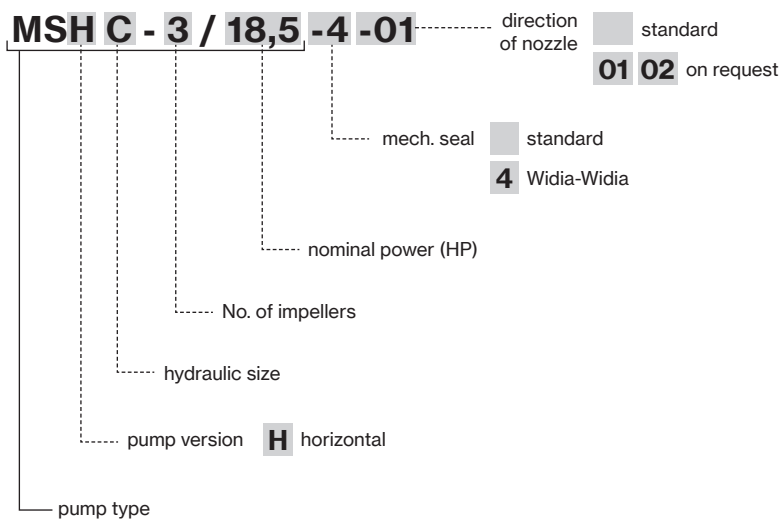

## MSH ~2900 rpm

TYPE		P2		P1 kW	I(A) 3- 400V	Q (m³/h - l/min - l/s)							
						0	6	9	12	15	18	21	24
		HP	kW				100	150	200	250	300	350	400
						H (m)							
MSHA	-3/5,5	7,5	5,5	6,0	10,1	88,2	86,3	83,7	78,6	71,2	62,6	53,4	43,2
	-4/7,5	10	7,5	7,8	13,0	118,0	116,7	113,0	106,5	96,8	85,2	73,1	59,7
	-5/9,2	12,5	9,2	9,8	16,4	148,2	145,9	138,8	130,0	119,8	105,2	90,7	73,8
	-6/11	15	11	11,8	19,6	177,5	174,2	168,9	158,9	144,2	126,7	107,9	88,0
	-8/15	20	15	15,5	26,3	237,8	233,4	227,0	213,8	194,8	171,4	146,0	119,5

TYPE		P2		P1 kW	I(A) 3- 400V	Q (m³/h - l/min - l/s)										
						0	12	15	18	21	24	27	30	33	36	39
		HP	kW				200	250	300	350	400	450	500	550	600	650
						H (m)										
MSHB	-2/7,5	10	7,5	8,2	13,4	74,5	72,7	71,1	68,7	66,1	62,4	58,3	53,8	49,0	43,9	38,6
	-3R/9,2	12,5	9,2	10,0	16,7	101,8	98,9	96,2	91,4	87,4	81,0	74,3	66,5	58,8	50,8	42,4
	-3/11	15	11	11,8	19,6	112,7	109,2	106,9	102,9	99,6	94,1	88,1	81,3	74,5	67,2	59,3
	-4/15	20	15	15,9	26,5	149,7	146,5	143,4	138,2	133,4	125,4	117,1	107,4	97,8	87,7	76,2
	-5/18,5	25	18,5	19,8	33,0	187,7	182,9	179,2	172,3	166,7	157,2	146,7	134,9	122,7	109,9	96,2
	-6/22	30	22	23,6	38,8	225,9	220,4	216,3	207,1	201,1	189,6	176,6	162,5	147,5	131,7	115,1

TYPE		P2		P1 kW	I(A) 3- 400V	Q (m³/h - l/min - l/s)								
						0	18	24	30	36	42	48	54	57
		HP	kW				300	400	500	600	700	800	900	950
						H (m)								
MSHC	-2R1/11	15	11	13,0	21,4	78,4	79,5	76,3	72,3	67,6	61,8	55,2	46,9	41,8
	-3R/15	20	15	17,4	28,9	110,4	111,9	107,2	101,5	94,5	85,8	75,3	61,5	53,0
	-3/18,5	25	18,5	20,5	34,0	127,6	128,8	124,7	118,8	111,9	104,0	95,1	85,3	79,2
	-4R1/22	30	22	25,3	41,5	159,5	159,0	153,6	145,7	136,3	125,0	112,2	98,1	88,3
	-5/30	40	30	34,6	59,4	214,7	215,7	208,6	198,9	187,2	173,9	158,5	141,2	130,9
	-6/37	50	37	41,2	72,8	256,5	257,1	249,2	238,2	224,6	209,0	191,3	170,7	158,9

TYPE		P2		P1 kW	I(A) 3- 400V	Q (m³/h - l/min - l/s)										
						0	30	36	42	48	54	60	66	72	78	84
		HP	kW				500	600	700	800	900	1000	1100	1200	1300	1400
						H (m)										
MSHD	-2/15	20	15	16,6	27,6	75,9	75,9	73,8	71,0	67,8	64,3	60,4	56,1	51,5	46,4	41,0
	-3R/18,5	25	18,5	20,3	33,7	99,6	99,6	96,0	91,7	87,5	82,7	77,1	70,8	64,0	56,6	48,5
	-3/22	30	22	23,7	39,3	113,1	113,9	110,8	106,7	102,0	96,9	91,4	85,4	78,8	71,2	63,0
	-4/30	40	30	33,0	57,2	152,0	152,5	148,9	144,1	138,7	132,4	125,1	117,0	108,1	98,8	89,0
	-5/37	50	37	40,6	71,9	189,6	191,4	186,4	179,9	173,3	165,7	157,0	147,0	136,0	124,5	112,3



# MSH ~2900 rpm

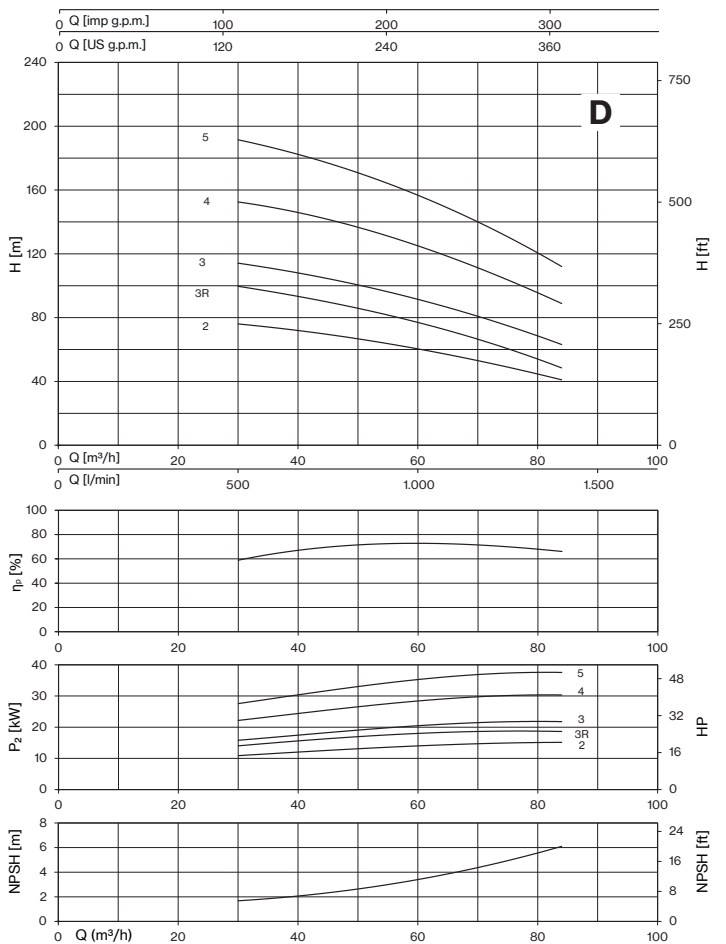
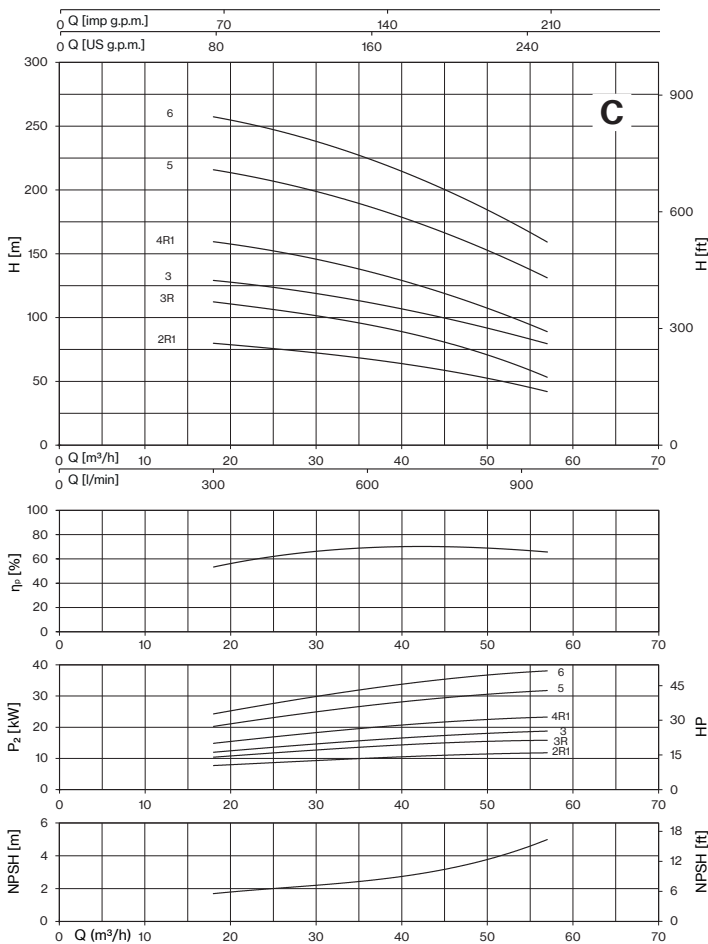
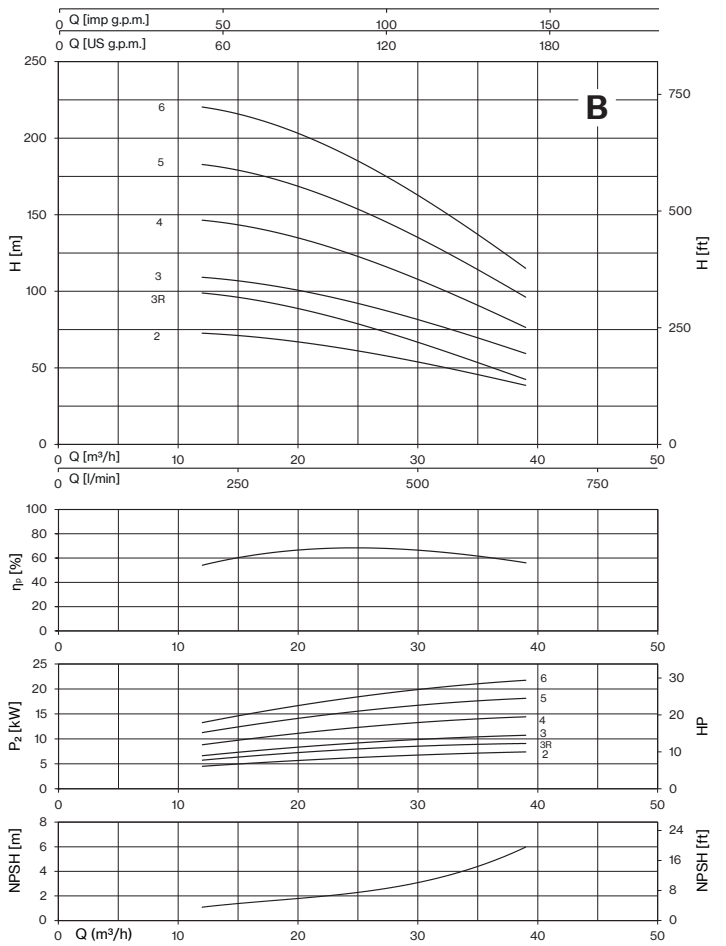
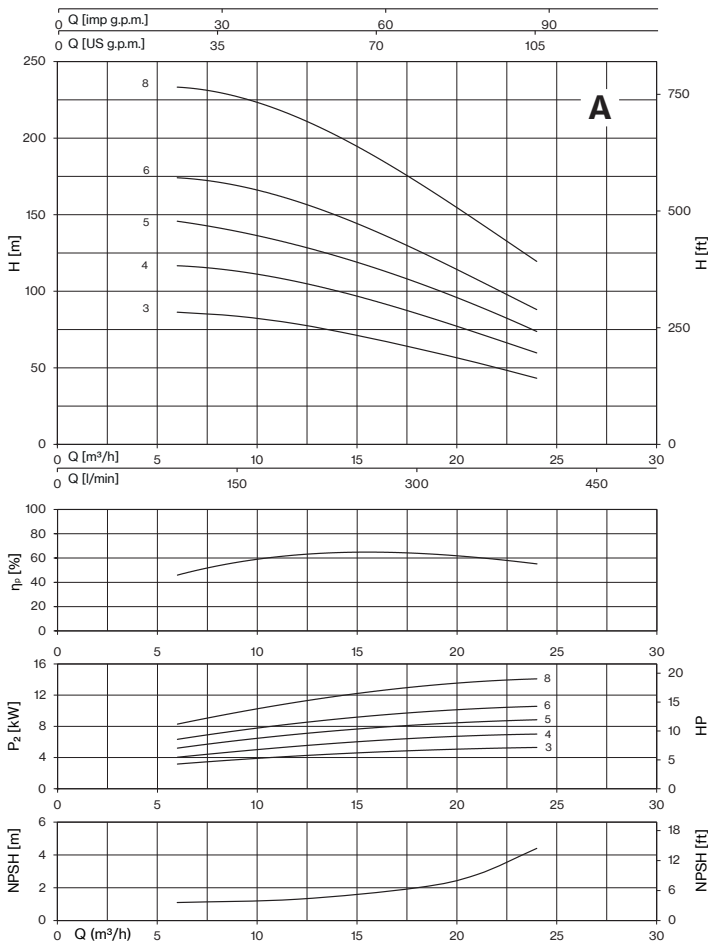

## 4MSH ~1450 rpm

TYPE		P2		Q (m³/h - l/min - l/s)									
				0	3	4,5	6	7,5	9	10,5	12	13,5	
		HP	kW		50	75	100	125	150	175	200	225	
				0,83	1,25	1,67	2,08	2,50	2,92	3,33	3,75		
				H (m)									
4MSHA	-8/2,2	3	2,2	56,0	55,7	54,2	51,3	46,3	40,2	33,4	25,7	16,2	

TYPE		P2		Q (m³/h - l/min - l/s)										
				0	6	7,5	9	10,5	12	13,5	16,5	19,5	22,5	
		HP	kW		100	125	150	175	200	225	275	325	375	
				1,67	2,08	2,50	2,92	3,33	3,75	4,58	5,42	6,25		
				H (m)										
4MSHB	-4/2,2	3	2,2	35,4	34,8	34,0	32,8	31,2	29,3	27,0	22,0	16,9	11,6	
	-5/2,2	3	2,2	44,3	43,5	42,5	41,0	39,0	36,6	33,8	27,5	21,1	14,6	
	-6/3	4	3	53,2	52,2	51,3	49,9	47,8	44,7	41,5	34,4	27,7	17,2	
	-8/4	5,5	4	70,9	69,6	68,3	66,5	63,7	59,7	55,3	45,9	36,9	23,0	

TYPE		P2		Q (m³/h - l/min - l/s)											
				0	9	10,5	12	13,5	16,5	19,5	22,5	24	27	30	33
		HP	kW		150	175	200	225	275	325	375	400	450	500	550
				2,50	2,92	3,33	3,75	4,58	5,42	6,25	6,67	7,50	8,33	9,17	
				H (m)											
4MSHC	-3/2,2	3	2,2	30,2	30,7	30,5	30,0	29,4	27,9	26,2	24,0	22,8	20,0	16,7	12,3
	-4/3	4	3	40,1	41,0	40,6	39,9	39,1	37,3	35,0	32,0	30,3	26,9	23,1	16,4
	-5/4	5,5	4	50,1	51,3	50,8	49,9	48,8	46,6	43,8	40,0	37,8	33,0	27,8	21,0
	-6/5,5	7,5	5,5	60,3	61,7	61,0	59,9	58,7	55,9	52,3	47,7	45,1	39,6	33,6	24,6

TYPE		P2		Q (m³/h - l/min - l/s)											
				0	13,5	16,5	19,5	22,5	24	27	30	33	39	45	48
		HP	kW		225	275	325	375	400	450	500	550	650	750	800
				3,75	4,58	5,42	6,25	6,67	7,50	8,33	9,17	10,83	12,50	13,33	
				H (m)											
4MSHD	-2/2,2	3	2,2	18,3	18,7	18,4	18,0	17,5	17,2	16,5	15,7	14,7	12,3	7,6	
	-3/3	4	3	27,1	27,7	27,3	26,7	26,0	25,6	24,6	23,5	22,0	18,4	14,2	
	-4/4	5,5	4	36,2	36,8	36,1	35,2	34,1	33,6	32,3	30,6	28,7	24,2	19,2	
	-5/5,5	7,5	5,5	45,2	46,3	45,4	44,4	43,2	42,6	41,0	39,0	36,6	30,9	25,3	22,0
	-6/7,5	10	7,5	54,2	55,5	54,5	53,2	51,9	51,1	49,1	46,8	43,9	37,0	30,3	26,0



# 4MSH ~1450 rpm

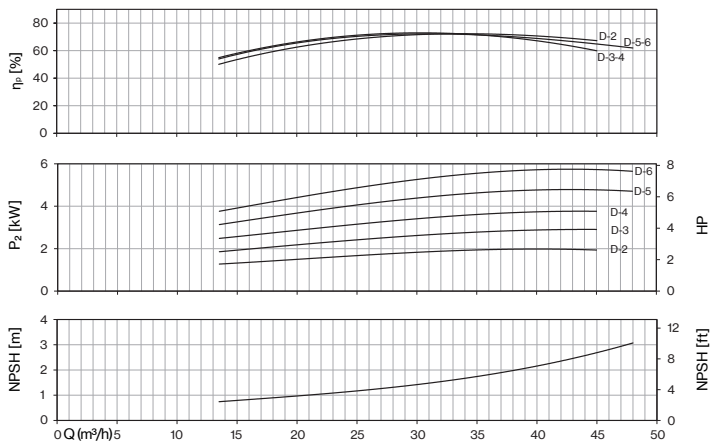
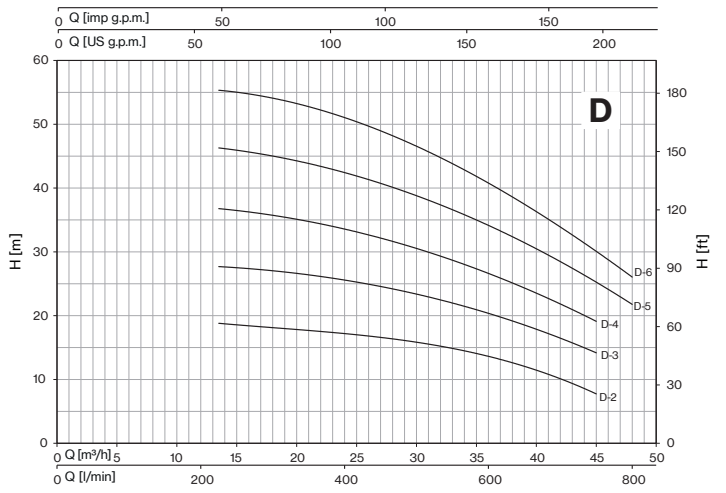
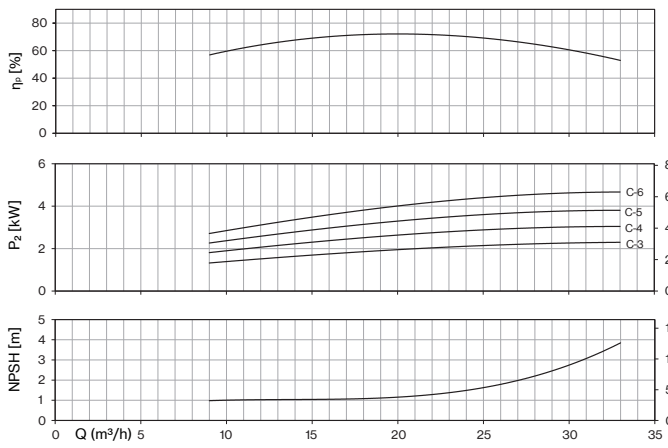
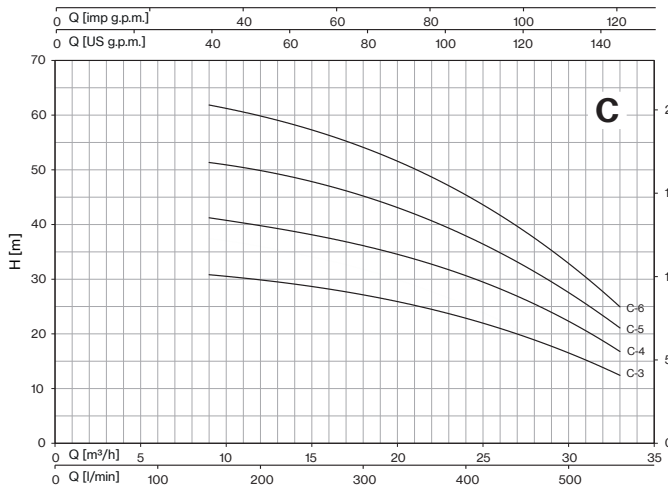
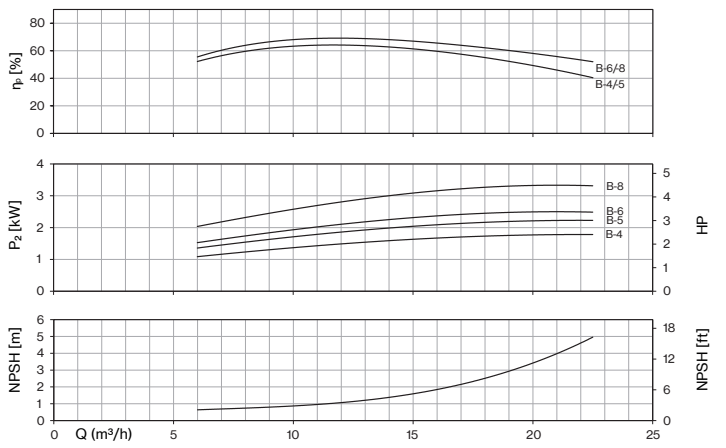
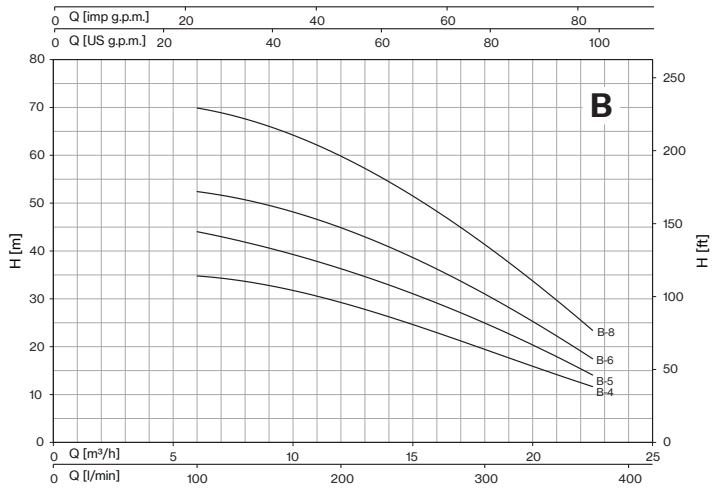
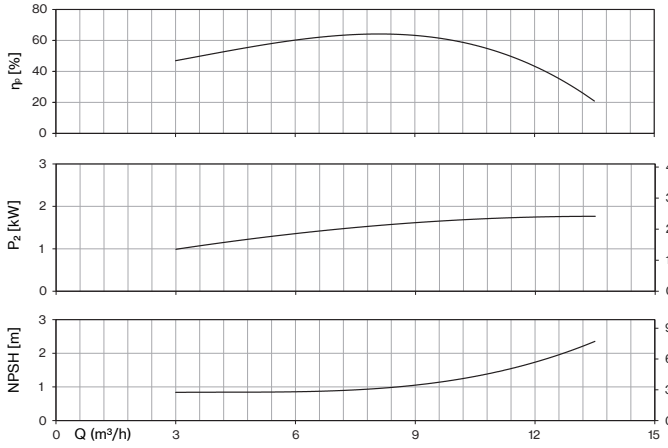
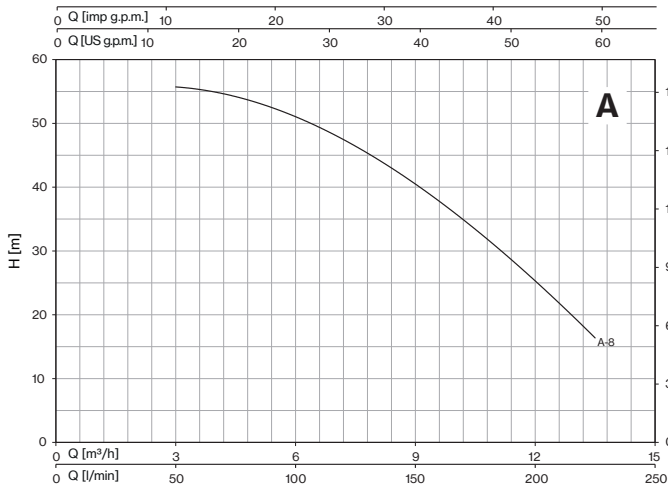

# MSH-4MSH

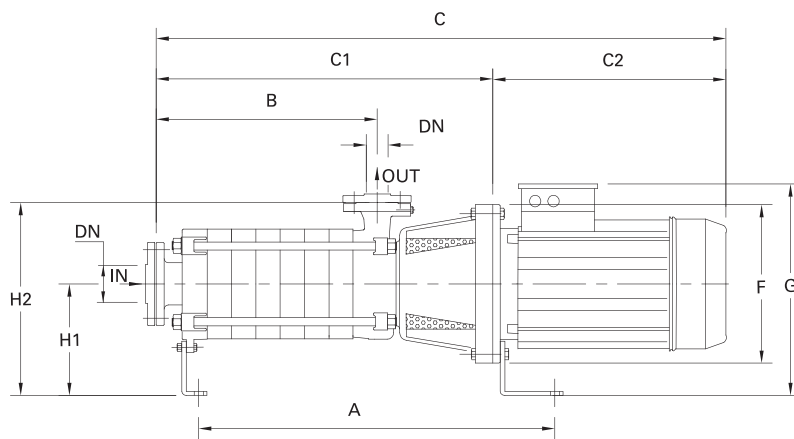

STANDARD

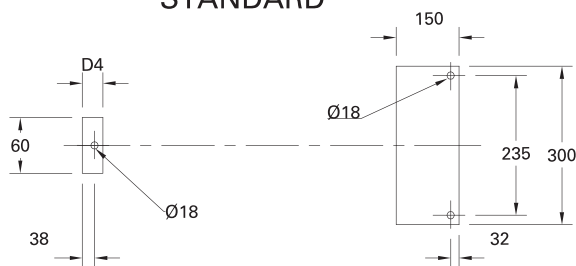

Direction of nozzles

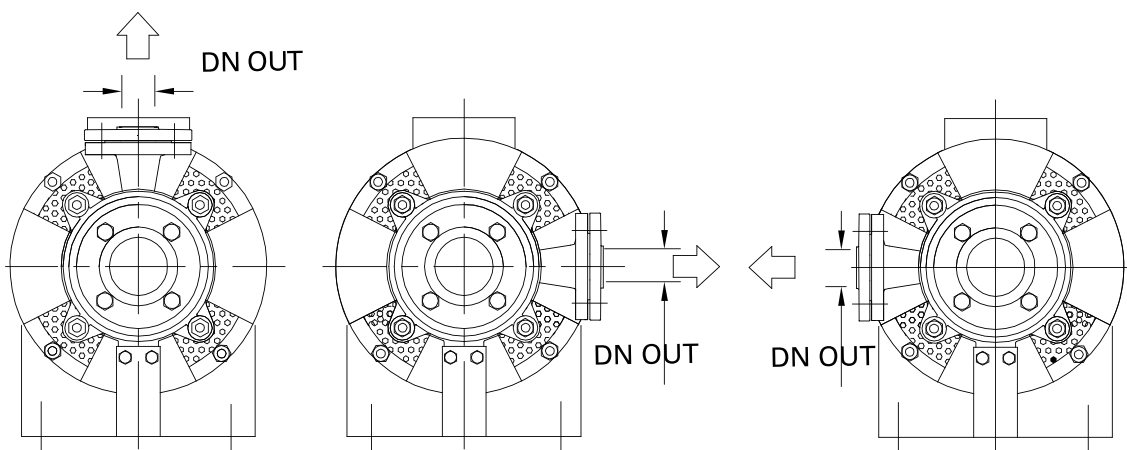

STANDARD

Pos. 01

Pos. 02

DIMENSIONS (mm)				
DN	D	K	holes	
			n°	∅
40	150	110	4	18
50	165	125	4	18
65	185	145	4	18
80	200	160	8	18

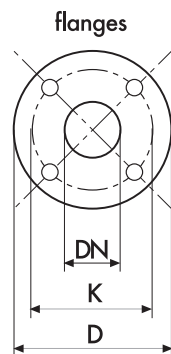

## MSH ~2900 rpm

TYPE	DN IN	DN OUT	N. STAGE	DIMENSIONS (mm)												Kg	
				A	B	C	C1	C2	F	G	H1	H2	D4	I	L		M
<b>MSHA -3/5,5</b>	(UNI PN 16) 65	(UNI PN 40) 40	3	604	256,5	922,5	545,5	377	300	425	245	420	70	1100	400	500	140,5
<b>MSHA -4/7,5</b>			4	655	307,5	973,5	596,5	377	300	425				1100	400	500	157
<b>MSHA -5/9,2</b>			5	706	358,5	1063,5	647,5	416	300	425				1100	400	500	173,5
<b>MSHA -6/11</b>			6	757	409,5	1114,5	698,5	416	300	425				1100	400	500	192,5
<b>MSHA -8/15</b>			8	859	511,5	1298,5	800,5	498	350	480				1400	500	500	259,5
<b>MSHB -2/7,5</b>	(UNI PN 16) 65	(UNI PN 40) 40	2	553	205,5	531,5	494,5	37	300	425	245	420	70	1100	400	500	137
<b>MSHB -3R/9,2</b>			3	604	256,5	961,5	545,5	416	300	425				1100	400	500	154
<b>MSHB -3/11</b>			3	604	256,5	961,5	545,5	416	300	425				1100	400	500	158
<b>MSHB -4/15</b>			4	655	307,5	1094,5	596,5	498	350	480				1400	500	500	220,5
<b>MSHB -5/18,5</b>			5	706	358,5	1188,5	647,5	541	350	480				1400	500	500	245
<b>MSHB -6/22</b>			6	757	409,5	1239,5	698,5	541	350	480				1400	500	500	265
<b>MSHC -2R1/11</b>	(UNI PN 16) 80	(UNI PN 40) 50	2	596	243	954	538	416	300	425	245	445	60	1100	400	500	165
<b>MSHC -3R/15</b>			3	656	303	1096	598	498	350	480				1100	400	500	231,5
<b>MSHC -3/18,5</b>			3	656	303	1139	598	541	350	480				1400	500	500	246,5
<b>MSHC -4R1/22</b>			4	716	363	1199	658	541	350	480				1400	500	500	270,5
<b>MSHC -5/30</b>			5	776	423	1286	718	568	350	495				1400	500	500	319
<b>MSHC -6/37</b>			6	836	483	1386	778	608	350	495				1400	500	500	358
<b>MSHD -2/15</b>	(UNI PN 10) 80	(UNI PN 40) 50	2	596	243	1036	538	498	350	480	245	445	60	1400	400	500	217
<b>MSHD -3R/18,5</b>			3	656	303	1139	598	541	350	480				1400	500	500	245
<b>MSHD -3/22</b>			3	656	303	1139	598	541	350	480				1400	500	500	255,5
<b>MSHD -4/30</b>			4	716	363	1226	658	568	350	495				1400	500	500	303
<b>MSHD -5/37</b>			5	776	423	1326	718	608	350	495				1400	500	500	340,5

## 4MSH ~1450 rpm

TYPE	DN IN	DN OUT	N. STAGE	DIMENSIONS (mm)												Kg	
				A	B	C	C1	C2	F	G	H1	H2	D4	I	L		M
<b>4MSHA -8/2,2</b>	(UNI PN 16) 65	(UNI PN 40) 40	8	822	511,5	1079	763,5	315	250	415	245	420	70	1100	400	500	183
<b>4MSHB -4/2,2</b>	(UNI PN 16) 65	(UNI PN 40) 40	4	618	511,5	875	559,5	315	250	415	245	420	70	1100	400	500	136
<b>4MSHB -5/2,2</b>			5	670	307,5	926	610,5	315	250	415				1400	500	500	140
<b>4MSHB -6/3</b>			6	720	358,5	977	661,5	315	250	415				1400	500	500	171
<b>4MSHB -8/4</b>			8	720	409,5	1104	763,5	340	250	438				1400	500	500	200
<b>4MSHC -3/2,2</b>	(UNI PN 16) 80	(UNI PN 40) 50	3	620	303	876	561	315	250	415	245	445	60	1100	400	500	192
<b>4MSHC -4/3</b>			4	680	363	936	621	315	250	415				1100	400	500	194
<b>4MSHC -5/4</b>			5	740	423	1021	681	340	250	438				1100	400	500	202
<b>4MSHC -6/5,5</b>			6	800	483	1126	741	385	300	468				1400	500	500	206
<b>4MSHD -2/2,2</b>	(UNI PN 10) 80	(UNI PN 40) 50	2	560	243	816	501	315	250	415	245	445	60	1100	400	500	135
<b>4MSHD -3/3</b>			3	620	303	876	561	315	250	415				1100	400	500	167
<b>4MSHD -4/4</b>			4	680	363	961	621	340	250	438				1100	400	500	189
<b>4MSHD -5/5,5</b>			5	740	423	1066	681	385	300	468				1100	400	500	194
<b>4MSHD -6/7,5</b>			6	887	483	1166	741	425	300	468				1400	500	500	218



# MSH-4MSH Serie-Mechanical seal and bearings

MECHANICAL SEAL	PUMP MODEL	SHAFT Ø		STANDARD MATERIAL	OPTIONAL
					4
	MSHA-3/5,5-132S   MSHB-2/7,5-132S   4MSHA-8/2,2   4MSHB-4/2,2   4MSHB-5/2,2   4MSHB-6/3   4MSHB-8/4	25mm	<b>Rotating face</b> <b>Stationary face</b> <b>Elastomer</b>	Ceramic Graphite NBR	Widia Widia NBR
	MSHC-2R1/11-132M   MSHD-2/15-160M   4MSHC-3/2,2   4MSHC-4/3   4MSHC-5/4   4MSHC-6/5,5-132S   4MSHD-2/2,2   4MSHD-3/3   4MSHD-4/4   4MSHD-5/5,5-132S   4MSHD-6/7,5-132St	35mm	<b>Rotating face</b> <b>Stationary face</b> <b>Elastomer</b>	Ceramic Graphite NBR	Widia Widia NBR
	MSHA-4/7,5-132S   MSHA-5/9,2-132M   MSHA-6/11-132M   MSHA-8/15-160M   MSHB-3R/9,2-132M   MSHB-3/11-132M   MSHB-4/15-160M   MSHB-5/18,5-160L   MSHB-6/22-160L	25mm / Balanced seal	<b>Rotating face</b> <b>Stationary face</b> <b>Elastomer</b>	Widia Graphite NBR	Widia Widia NBR
	MSHC-3R/15-160M   MSHC-3/18,5-160L   MSHC-4R1/22-160L   MSHC-5/30-180M   MSHC-6/37-180L   MSHD-3R/18,5-160L   MSHD-3/22-160L   MSHD-4/30-180M   MSHD-5/37-180L	35mm / Balanced seal	<b>Rotating face</b> <b>Stationary face</b> <b>Elastomer</b>	Widia Graphite NBR	Widia Widia NBR

BEARINGS	PUMP MODEL	TYPE	
	4MSHA-8/2,2   4MSHB-4/2,2   4MSHB-5/2,2   4MSHC-3/2,2   4MSHD-2/2,2	6205-ZZ C3	6205-ZZ C3
	4MSHB-6/3   4MSHB-8/4   4MSHC-4/3   4MSHC-5/4   4MSHD-3/3   4MSHD-4/4	6206-ZZ C3	6206-ZZ C3
	MSHA-3/5,5-132S   MSHA-4/7,5-132S   MSHA-5/9,2-132M   MSHA-6/11-132M   MSHB-2/7,5-132S   MSHB-3R/9,2-132M   MSHB-3/11-132M   MSHC-2R1/11-132M	6206-ZZ C3	6308-ZZ C3
	4MSHC-6/5,5-132S   4MSHD-5/5,5-132S   4MSHD-6/7,5-132S	6208-ZZ C3	6208-ZZ C3
	MSHA-8/15-160M   MSHB-4/15-160M   MSHB-5/18,5-160L   MSHB-6/22-160L   MSHC-3R/15-160M   MSHC-3/18,5-160L   MSHC-4R1/22-160L   MSHD-2/15-160M   MSHD-3R/18,5-160L   MSHD-3/22-160L	6308-ZZ C3	6309-ZZ C3
	MSHC-5/30-180M   MSHC-6/37-180L   MSHD-4/30-180M   MSHD-5/37-180L	6309-ZZ C3	3310-ZZ C3

