

40mm Beam Pitch Area Sensor NA40 Series

CMJE-NA40 No.0035-93V

Thank you very much for purchasing Panasonic products. Please read this Instruction Manual carefully and thoroughly for the correct and optimum use of this product. Kindly keep this manual in a convenient place for quick reference.

- If this product is used as a sensing device for personnel protection, serious body injury or death could result.
- Never use this product as a sensing device with any press machine, shearing machine, roll grinding machine, forming machine, vulcanizer, or robot etc. for protection of a hand or a part of the body.
- This product does not include a self-checking circuit for safety functions necessary to allow its use as a safety device. Thus, a system failure or malfunction can result in either an energized or a de-energized output condition.
- When this product is used as a sensing device in the following applications and if a problem relating to 'law' or 'product liability' occurs, Panasonic Industrial Devices SUNX shall not be liable for the failure and for the damage or loss.
 - 1) Use of this product installed to a machinery or a device as a sensing device to detect a hand or a part of the operator's body entering a dangerous area and stop the machinery or the device.
 - 2) Installation of this product to a protection device for preventing to enter a dangerous area and use of this as a sensing device which detects a hand or a part of the operator's body and open / close the door or window.
 - 3) Use of this product as a sensing device for personnel protection (including interlock).
- For sensing devices to be used as safety devices for press machines or for personnel protection, use products which meet laws and standards, such as OSHA, ANSI or IEC etc., for personnel protection applicable in each region or country.
- In case of using as a safety device for press machines, use a product approved by the Ministry of Labor in Japan.

1 CAUTIONS

- Make sure to carry out the wiring in the power supply off condition.
- Take care that wrong wiring will damage the sensor.
- Verify that the supply voltage variation is within the rating.
- If power is supplied from a commercial switching regulator, ensure that the frame ground (F.G.) terminal of the power supply is connected to an actual ground.
- In case noise generating equipment (switching regulator, inverter motor, etc.) is used in the vicinity of this product, connect the frame ground (F.G.) terminal of the equipment to an actual ground.
- Do not run the wires together with high-voltage lines or power lines or put them in the same raceway. This can cause malfunction due to induction.
- Do not use during the initial transient time (0.5 sec.) after the power supply is switched on.
- Do not use the sensor without the front cover or the enclosure. IP protection cannot be maintained and a contact failure may occur between modular units.
- Avoid dust, dirt, and steam.
- Take care that the product does not come in direct contact with organic solvents, such as, thinner, etc.
- Take care that the sensor is not directly exposed to fluorescent light from a rapid-starter lamp or a high frequency lighting device, as it may affect the sensing performance.
- This sensor is suitable for indoor use only.
- Extension up to total 100m is possible with a 0.5mm², or more, cable for both emitter and receiver.
- Install the sensor where it cannot be affected by a beam reflected from a machinery frame or a workpiece. If the reflected beam is received, beam interruption is not achieved.
- The emitter and the receiver must face each other correctly. If they are set upside down, the sensor does not work.
- Make sure that stress by forcible bend or pulling is not applied directly to the sensor cable joint.
- When mounting the sensor, the tightening torque should be 1.96N·m or less.

2 PART DESCRIPTION

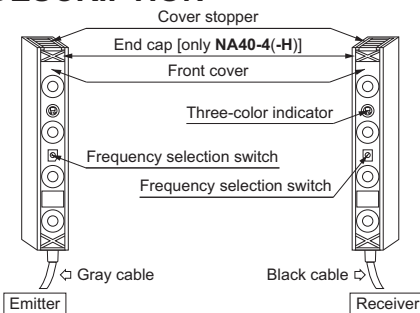

3 OPERATION OF INDICATOR

	Sensing output operation	Indicator operation		
		Sensing output operation indicator (Red)	Stable incident beam indicator (Green)	Unstable incident beam indicator (Yellow)
High incident light	Beam received operation (ON)		Lights up	
125%				Lights up
100%				
0%	Beam interrupted operation (OFF)	Lights up		

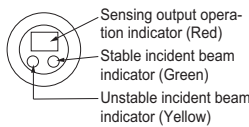

Note: If the sensing output transistor fails, the three-color indicators blink.

4 CONNECTION

I/O circuit diagram

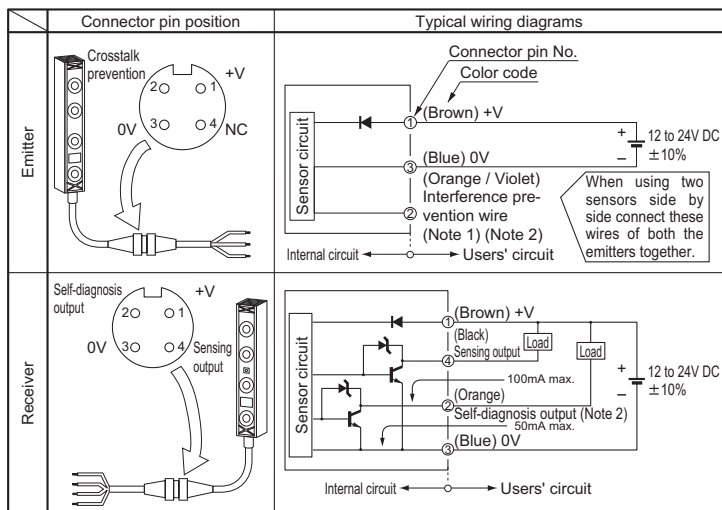

Notes: 1) If the interference prevention wires (orange / violet) are not used, please insulate them.
2) Never connect the emitter's interference prevention wire (orange / violet) to the receiver's self-diagnosis output (orange). This can cause damage.

5 LIGHT BEAM ALIGNMENT

- 1) Place the emitter and receiver face to face. Move the emitter right and left and find the stable light receiving range with observing the stable operation indicator (green). Place the emitter in the middle of the horizontal range.
- 2) Move the emitter up and down to find the stable light receiving range with observing the stable operation indicator.
- 3) Place the emitter in the middle of the vertical range. Adjust the receiver in the same way as described at the previous steps 1) and 2).
- 4) Make sure that the stable operation indicator (green) lights up.

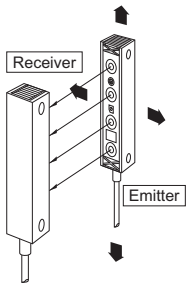

6 SETTING OF INTERFERENCE PREVENTION FUNCTION

- Make sure that the power supply is off while operating the frequency selection switch. If the switch is operated while the power is on, the sensor may go into the operation stopped state. However, to restart the sensor, turn the power off and on again.
- The frequency selection switch should not be set to the positions other than those specified below.
- When the sensor A breaks down due to any reason, the sensor B goes into the operation stopped state. In order to check the operation of the sensor B, set the frequency selection switch to '1'. Note that when only the sensor B breaks down, the sensor A keeps operation correctly.

When using two sets of sensor

- Up to two sets of sensors can be mounted close together by using the interference prevention function. Set the interference prevention function in the following procedure.

- 1) Set the frequency selection switch. Firstly, push up the front cover while pressing the cover stopper towards the arrow shown in the right figure.
- 2) Turn the frequency selection switch with the accessory adjusting screwdriver to select the frequency.

		Frequency selection switches	
		Emitter	Receiver
Sensor A			
Sensor B			

Set the switches of both the emitter and the receiver of Sensor A at '1', and both switches of Sensor B at '2'. The sensors do not function normally at other settings.

3) Connect the interference prevention wire (INTER LOCK) of Sensor A and B.

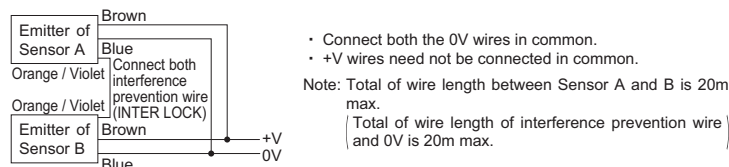

- Connect both the 0V wires in common.
 - +V wires need not be connected in common.
- Note: Total of wire length between Sensor A and B is 20m max.
(Total of wire length of interference prevention wire) and 0V is 20m max.

When using one set of sensor

- When the interference prevention function is not used (when one set of sensor is used) make sure that the frequency selection switch in both the emitter and receiver is set to '1'. If the switch is set to other than that, the sensor may not operate properly.

Frequency selection switches	
Emitter	Receiver

7 SELF-DIAGNOSIS OUTPUT

- The self-diagnosis function will be activated if any of the following error states occur.
 - 1) The sensor is moved from its correct mounting position, or unstable operation continues for 5 seconds or more as front cover of the sensor becomes dirty.
 - 2) Take sensing output transistor is damaged.
- ★ Take the following countermeasures if the self-diagnosis function is activated.

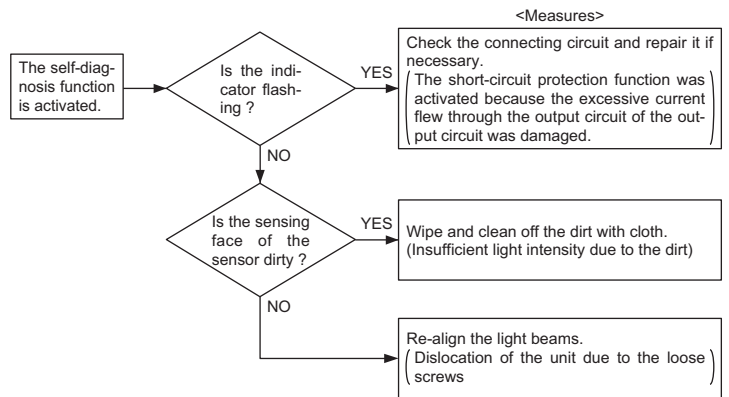

8 SPECIFICATIONS

Model-wise specifications

Item	4		6		8		10		12		
	Model No.	NA40-4	NA40-6	NA40-8	NA40-10	NA40-12	NA40-4-H	NA40-6-H	NA40-8-H	NA40-10-H	NA40-12-H
Sensing height		120mm	200mm	280mm	360mm	440mm					
Current consumption		Emitter: 30mA or less Receiver: 60mA or less				Emitter: 35mA or less Receiver: 90mA or less					
Weight (total of the emitter and the receiver)		400g approx.	500g approx.	630g approx.	770g approx.	890g approx.	With spatter protection hood				
		500g approx.	630g approx.	800g approx.	990g approx.	1,150g approx.					

Item	14		16		20		24		
	Model No.	NA40-14	NA40-16	NA40-20	NA40-40	NA40-14-H	NA40-16-H	NA40-20-H	NA40-40-H
Sensing height		520mm	600mm	760mm	920mm				
Current consumption		Emitter: 35mA or less Receiver: 90mA or less				Emitter: 35mA or less Receiver: 115mA or less			
Weight (total of the emitter and the receiver)		1,020g approx.	1,150g approx.	1,400g approx.	1,660g approx.	With spatter protection hood			
		1,330g approx.	1,500g approx.	1,840g approx.	2,190g approx.				

Common specifications

Sensing range	5m
Beam pitch	40mm
Sensing object	φ 60mm or more opaque object
Supply voltage	12 to 24V DC ± 10% Ripple P-P 10% or less
Sensing output	NPN open-collector transistor • Maximum sink current: 100mA • Applied voltage: 30V DC or less (between sensing output and 0V) • Residual voltage: 1.6V or less (at 100mA sink current)
Output operation	ON when all beams are received / OFF when one or more beams are interrupted
Short-circuit protection	Incorporated
Self-diagnosis output	NPN open-collector transistor • Maximum sink current: 50mA • Applied voltage: 30V DC or less (between self-diagnosis output and 0V) • Residual voltage: 1.6V or less (at 50mA sink current)
Output operation	OFF when unstable light received condition continues for 5 sec. or more, or the output transistor fails
Short-circuit protection	Incorporated
Response time	12ms or more
Indicators	Incorporated with the three-color indicators on the receiver • Sensing output operation indicator: Red LED (lights up when one or more beams are interrupted) • Stable incident beam indicator: Green LED (lights up when all beams are received stably) • Unstable incident beam indicator: Yellow LED (lights up when one or more beams are received unstably) • When the output transistor fails, the three color indicators blink simultaneously.
Interference prevention function	Incorporated
Protection	IP65 (IEC)
Ambient temperature	-10 to +50°C (No dew condensation or icing allowed) Storage: -10 to +60°C
Ambient humidity	35 to 85% RH, Storage: 35 to 85% RH
Emitting element	Infrared LED (synchronized scanning system)
Material	Protection enclosure: Aluminum, Unit case: ABS, Front cover: Acrylic, Lens: Acrylic
Cable	0.5mm ² 4-core (emitter: 3-core) cabtyre cable, 0.5m long, with a round connector at the end * Use together with the optional mating cable
Accessories	MS-NA40-1 (Sensor mounting bracket): 1 set, Adjusting screwdriver: 1

9 HOW TO CHANGE THE NUMBER OF BEAM CHANNELS

- 1) Push up the front cover while pressing the cover stopper towards.
- 2) Remove the four fixing screws on the rear face. Pull the modules upward one by one with your hands.

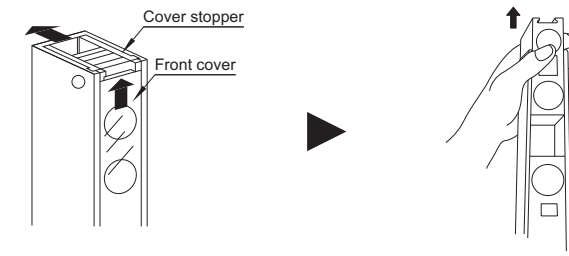

- 4) Tighten the four fixing screws and insert the front cover by pulling the cover stopper back.
- 3) Prepare the new protection enclosure and front cover that matches the required sensing height. Insert the units and connect the end cap.

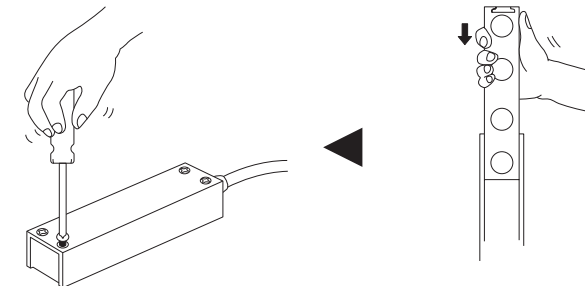

Notes: 1) Be sure to turn the power off before linking units. If this is not done, the sensor may get damaged.
2) The end unit, either 2-channel unit or 4-channel unit, must be connected at the top of the module linkage.
3) Be sure to put the end cap on the top of the 4 beam channel NA40-4 or NA40-4-H.
4) The cover stopper and four fixing screws are attached with the protection enclosure.
5) When the additional units are used, be sure to use the units that are from the identical series. If the other units are used, the sensor may get damaged.

10 DIMENSIONS (Unit: mm)

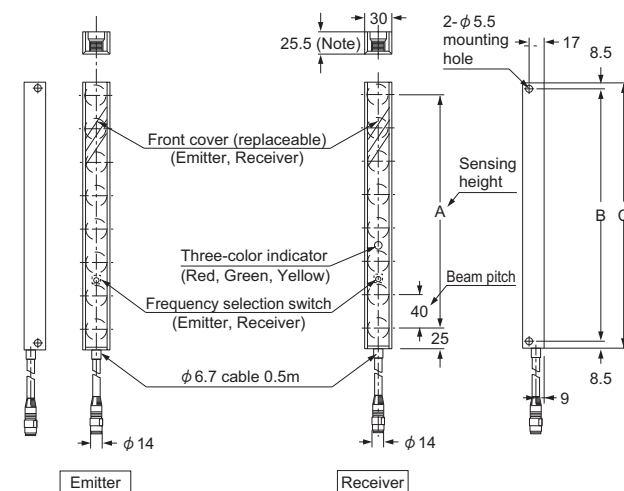

Note: The spatter protection hood case is 50mm broad. The view holes are prepared on both sides to see indicators.

Model No.	A	B	C
NA40-4(-H)	120	163	180
NA40-6(-H)	200	233	250
NA40-8(-H)	280	313	330
NA40-10(-H)	360	393	410
NA40-12(-H)	440	473	490
NA40-14(-H)	520	553	570
NA40-16(-H)	600	633	650
NA40-20(-H)	760	793	810
NA40-24(-H)	920	953	970

Panasonic Industrial Devices SUNX Co., Ltd.

http://panasonic.net/id/pidsx/global
Overseas Sales Division (Head Office)
 2431-1 Ushiyama-cho, Kasugai-shi, Aichi, 486-0901, Japan
 Phone: +81-568-33-7861 FAX: +81-568-33-8591
 *About our sale network, please visit our website.