

# **RIDA™ DBT6400**

Pocket Handheld Imager Scanner  
with Bluetooth® Wireless Technology

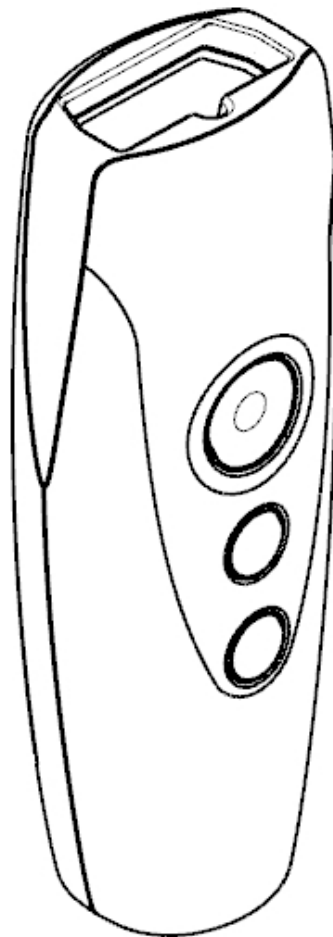

**Product Reference Guide**

## **Datalogic USA Inc.**

959 Terry Street  
Eugene, OR 97402  
U.S.A.

Telephone: (541) 683-5700

Fax: (541) 345-7140

### **©2016-2018 Datalogic S.p.A. and/or its affiliates**

♦ All rights reserved. ♦ Without limiting the rights under copyright, no part of this documentation may be reproduced, stored in or introduced into a retrieval system, or transmitted in any form or by any means, or for any purpose, without the express written permission of Datalogic S.p.A. and/or its affiliates. Owners of Datalogic products are hereby granted a non-exclusive, revocable license to reproduce and transmit this documentation for the purchaser's own internal business purposes. Purchaser shall not remove or alter any proprietary notices, including copyright notices, contained in this documentation and shall ensure that all notices appear on any reproductions of the documentation. Should future revisions of this manual be published, you can acquire printed versions by contacting your Datalogic representative. Electronic versions may either be downloadable from the Datalogic website ([www.datalogic.com](http://www.datalogic.com)) or provided on appropriate media. If you visit our website and would like to make comments or suggestions about this or other Datalogic publications, please let us know via the "Contact Datalogic" page.

### **Disclaimer**

Datalogic has taken reasonable measures to provide information in this manual that is complete and accurate, however, Datalogic reserves the right to change any specification at any time without prior notice.

Datalogic and the Datalogic logo are registered trademarks of Datalogic S.p.A. in many countries, including the U.S. and the E.U.

RIDA and Datalogic Aladdin are trademarks of Datalogic S.p.A. and/or its affiliates.

The Bluetooth word mark and logos are owned by Bluetooth SIG, Inc. and any use of such marks by Datalogic Group companies is under license. All other brand and product names may be trademarks of their respective owners.

### **Patents**

See [www.patents.datalogic.com](http://www.patents.datalogic.com) for patent list.



# Table of Contents

<b>INTRODUCTION</b> .....	<b>1</b>
<b>About the Scanner</b> .....	<b>1</b>
Using the RIDA DBT6400 .....	1
<b>About this Manual</b> .....	<b>3</b>
Overview .....	3
Manual Conventions .....	3
<b>Technical Support</b> .....	<b>4</b>
Datalogic Website Support .....	4
Reseller Technical Support .....	4
Telephone Technical Support .....	4
<b>SETUP</b> .....	<b>5</b>
<b>Unpacking</b> .....	<b>5</b>
<b>Setting Up the Reader</b> .....	<b>5</b>
Configuring the BC6020 Base Station .....	5
Using the BC6020 Base Station .....	6
Charging the Batteries .....	7
Replacing the Battery Pack .....	8
<b>Linking to a Host</b> .....	<b>9</b>
<b>Linking to a Base Station</b> .....	<b>11</b>
<b>Base Station Interface Selection</b> .....	<b>12</b>
Configuring the Interface .....	12
<b>Customizing Configuration Settings</b> .....	<b>13</b>
Using the Programming barcodes .....	13
Interface Settings .....	14
Configuring Other Features .....	14
Software Version Transmission .....	14
<b>Compatibility</b> .....	<b>16</b>
Supported BT Specification .....	16
Device and operative system supported .....	16
Tested Devices .....	17
<b>Cleaning Procedure</b> .....	<b>18</b>
Cleaning plastic surfaces .....	18
Cleaning electrical contact surfaces .....	19
Scanner and cradle deep cleaning .....	20
<b>CONFIGURATION USING BARCODES</b> .....	<b>21</b>
<b>Configuration Parameters</b> .....	<b>21</b>
<b>Global Interface Features</b> .....	<b>23</b>
Host Commands — Obey/Ignore .....	23
USB Suspend Mode .....	24
<b>USB-COM INTERFACES</b> <b>25</b>	
<b>Standard Factory Settings</b> .....	<b>25</b>
<b>Intercharacter Delay</b> .....	<b>26</b>
<b>Beep On ASCII BEL</b> .....	<b>27</b>
<b>Beep On Not on File</b> .....	<b>27</b>
<b>ACK NAK Options</b> .....	<b>28</b>
ACK Character .....	29
NAK Character .....	29
ACK NAK Timeout Value .....	30
ACK NAK Retry Count .....	31
ACK NAK Error Handling .....	32
<b>Indicate Transmission Failure</b> .....	<b>33</b>
<b>Disable Character</b> .....	<b>33</b>

Enable Character .....	34
<b>KEYBOARD INTERFACE 35</b>	
<b>Country Mode .....</b>	<b>36</b>
Setup on PC to use ALT Universal .....	36
Setting Country Mode .....	37
Setting Encoding Type .....	51
Setting ALT output type .....	58
<b>Caps Lock State .....</b>	<b>58</b>
<b>Numlock .....</b>	<b>59</b>
<b>Keyboard Numeric Keypad .....</b>	<b>59</b>
<b>Keyboard Send Control Characters .....</b>	<b>60</b>
<b>Intercharacter Delay .....</b>	<b>61</b>
<b>Intercode Delay .....</b>	<b>62</b>
<b>USB Keyboard Speed .....</b>	<b>63</b>
<b>USB-OEM INTERFACE 65</b>	
<b>Introduction .....</b>	<b>65</b>
<b>Standard Factory Settings .....</b>	<b>65</b>
<b>USB-OEM Device Usage .....</b>	<b>66</b>
<b>USB-OEM Interface Options .....</b>	<b>66</b>
<b>DATA FORMAT 67</b>	
<b>Global Prefix/Suffix .....</b>	<b>68</b>
<b>Global AIM ID .....</b>	<b>69</b>
<b>GS1-128 AIM ID .....</b>	<b>69</b>
<b>Label ID .....</b>	<b>70</b>
Label ID: Pre-loaded Sets .....	70
Label ID: Set Individually Per Symbology .....	71
Label ID Control .....	71
Individually Set Label ID .....	72
<b>Case Conversion .....</b>	<b>78</b>
<b>Character Conversion .....</b>	<b>78</b>
<b>READING PARAMETERS 79</b>	
<b>Double Read Timeout .....</b>	<b>80</b>
<b>LED and Speaker Indicators .....</b>	<b>82</b>
Power On Alert .....	82
<b>Audio Jingles .....</b>	<b>82</b>
Audio Jingle Enable .....	83
Select Audio Jingle for Power-up Event .....	84
Select Audio Jingle for Good Read Event .....	85
Select Audio Jingle for Enter Base Station .....	86
Select Audio Jingle for Exit Base Station .....	87
Select Audio Jingle for Transmit Error Sound .....	88
Good Read: When to Indicate .....	89
Good Read Beep Type .....	90
Good Read Beep Frequency .....	90
Good Read Speaker Volume .....	91
Good Read Beep Length .....	92
<b>RGB LED Settings .....</b>	<b>94</b>
Enable/Disable Good Read Indicator .....	95
Good Read LED Color .....	95
Enable/Disable Body Illumination .....	96
Scanner Idle LED Color .....	97
RGB Good Read Raising Time .....	98
RGB Good Read Falling Time .....	99
RGB Good Read Holding Time .....	100
RGB Auto Delay .....	101
Viber .....	102
<b>Scanning Features .....</b>	<b>103</b>
Scan Mode .....	103
Scanning Active Time .....	104
Pick Mode .....	104
<b>1D SYMBOLOGIES 105</b>	
<b>Introduction .....</b>	<b>105</b>

<b>Standard Factory Settings for Symbologies</b> .....	<b>105</b>
<b>Disable All Symbologies</b> .....	<b>106</b>
<b>Coupon Control</b> .....	<b>106</b>
<b>UPC-A</b> .....	<b>107</b>
UPC-A Enable/Disable .....	107
UPC-A Check Character Transmission .....	107
Expand UPC-A to EAN-13 .....	108
UPC-A Number System Character Transmission .....	108
<b>UPC-E</b> .....	<b>109</b>
UPC-E Enable/Disable .....	109
UPC-E Check Character Transmission .....	109
Expand UPC-E to EAN-13 .....	110
Expand UPC-E to UPC-A .....	110
UPC-E Number System Character Transmission .....	111
<b>EAN 13</b> .....	<b>112</b>
EAN 13 Enable/Disable .....	112
EAN 13 Check Character Transmission .....	112
EAN-13 Flag 1 Character .....	113
EAN-13 ISBN Conversion .....	113
ISSN Enable/Disable .....	114
<b>EAN 8</b> .....	<b>115</b>
EAN 8 Enable/Disable .....	115
EAN 8 Check Character Transmission .....	115
Expand EAN 8 to EAN 13 .....	116
.....	116
<b>UPC/EAN Global Settings</b> .....	<b>117</b>
UPC/EAN Price Weight Check .....	117
<b>Add-Ons</b> .....	<b>118</b>
Optional Add-ons .....	118
Optional Add-On Timer .....	119
<b>GS1 DataBar™ Omnidirectional</b> .....	<b>120</b>
GS1 DataBar Omnidirectional Enable/Disable .....	120
GS1 DataBar Omnidirectional GS1-128 Emulation .....	120
<b>GS1 DataBar™ Expanded</b> .....	<b>121</b>
GS1 DataBar Expanded Enable/Disable .....	121
GS1 DataBar Expanded GS1-128 Emulation .....	121
GS1 DataBar Expanded Length Control .....	122
GS1 DataBar Expanded Set Length 1 .....	122
GS1 DataBar Expanded Set Length 2 .....	123
<b>GS1 DataBar™ Limited</b> .....	<b>124</b>
GS1 DataBar Limited Enable/Disable .....	124
GS1 DataBar Limited GS1-128 Emulation .....	124
<b>Code 39</b> .....	<b>125</b>
Code 39 Enable/Disable .....	125
Code 39 Check Character Calculation .....	126
Code 39 Check Character Transmission .....	127
Code 39 Start/Stop Character Transmission .....	127
Code 39 Full ASCII .....	128
Code 39 Quiet Zones .....	129
Code 39 Length Control .....	130
Code 39 Set Length 1 .....	131
Code 39 Set Length 2 .....	132
<b>Code 32 (Italian Pharmaceutical)</b> .....	<b>133</b>
Code 32 Enable/Disable .....	133
Code 32 Feature Setting Exceptions .....	133
Code 32 Check Character Transmission .....	133
Code 32 Start/Stop Character Transmission .....	134
<b>Code 39 CIP (French Pharmaceutical)</b> .....	<b>134</b>
Code 39 CIP Enable/Disable .....	134
<b>Code 128</b> .....	<b>135</b>
Code 128 Enable/Disable .....	135
Expand Code 128 to Code 39 .....	135

Code 128 Check Character Transmission .....	136
Code 128 Function Character Transmission .....	136
Code 128 Quiet Zones .....	137
Code 128 Length Control .....	138
Code 128 Set Length 1 .....	139
Code 128 Set Length 2 .....	140
<b>GS1-128 .....</b>	<b>141</b>
GS1-128 Enable .....	141
<b>Interleaved 2 of 5 (I 2 of 5) .....</b>	<b>142</b>
I 2 of 5 Enable/Disable .....	142
I 2 of 5 Check Character Calculation .....	143
I 2 of 5 Check Character Transmission .....	144
I 2 of 5 Length Control .....	145
I 2 of 5 Set Length 1 .....	146
I 2 of 5 Set Length 2 .....	147
<b>Interleaved 2 of 5 CIP HR .....</b>	<b>148</b>
Interleaved 2 of 5 CIP HR Enable/Disable .....	148
<b>Datalogic 2 of 5 .....</b>	<b>149</b>
Datalogic 2 of 5 Enable/Disable .....	149
Datalogic 2 of 5 Check Character Calculation .....	149
Datalogic 2 of 5 Check Character Transmission .....	150
Datalogic 2 of 5 Length Control .....	150
Datalogic 2 of 5 Set Length 1 .....	151
Datalogic 2 of 5 Set Length 2 .....	152
<b>Codabar .....</b>	<b>153</b>
Codabar Enable/Disable .....	153
Codabar Check Character Calculation .....	153
Codabar Check Character Transmission .....	154
Codabar Start/Stop Character Transmission .....	154
Codabar Start/Stop Character Set .....	155
Codabar Start/Stop Character Match .....	155
Codabar Quiet Zones .....	156
Codabar Length Control .....	157
Codabar Set Length 1 .....	158
Codabar Set Length 2 .....	159
<b>ABC Codabar .....</b>	<b>160</b>
ABC Codabar Enable/Disable .....	160
ABC Codabar Concatenation Mode .....	160
ABC Codabar Dynamic Concatenation Timeout .....	161
ABC Codabar Force Concatenation .....	161
<b>Code 11 .....</b>	<b>162</b>
Code 11 Enable/Disable .....	162
Code 11 Check Character Calculation .....	163
Code 11 Check Character Transmission .....	163
Code 11 Length Control .....	164
Code 11 Set Length 1 .....	164
Code 11 Set Length 2 .....	165
<b>Standard 2 of 5 .....</b>	<b>166</b>
Standard 2 of 5 Enable/Disable .....	166
Standard 2 of 5 Check Character Calculation .....	166
Standard 2 of 5 Check Character Transmission .....	167
Standard 2 of 5 Length Control .....	167
Standard 2 of 5 Set Length 1 .....	168
Standard 2 of 5 Set Length 2 .....	169
<b>Industrial 2 of 5 .....</b>	<b>170</b>
Industrial 2 of 5 Enable/Disable .....	170
Industrial 2 of 5 Check Character Calculation .....	170
Industrial 2 of 5 Check Character Transmission .....	171
Industrial 2 of 5 Length Control .....	171
Industrial 2 of 5 Set Length 1 .....	172
Industrial 2 of 5 Set Length 2 .....	173
<b>IATA .....</b>	<b>174</b>

IATA Enable/Disable .....	174
IATA Check Character Transmission .....	174
<b>ISBT 128 .....</b>	<b>175</b>
ISBT 128 Concatenation .....	175
ISBT 128 Concatenation Mode .....	175
ISBT 128 Dynamic Concatenation Timeout .....	176
ISBT 128 Force Concatenation .....	177
ISBT 128 Advanced Concatenation Options .....	177
<b>MSI .....</b>	<b>178</b>
MSI Enable/Disable .....	178
MSI Check Character Calculation .....	178
MSI Check Character Transmission .....	179
MSI Length Control .....	179
MSI Set Length 1 .....	180
MSI Set Length 2 .....	181
<b>Code 93 .....</b>	<b>182</b>
Code 93 Enable/Disable .....	182
Code 93 Check Character Calculation .....	183
Code 93 Check Character Transmission .....	183
Code 93 Length Control .....	184
Code 93 Set Length 1 .....	185
Code 93 Set Length 2 .....	186
Code 93 Quiet Zones .....	187
<b>Follett 2 of 5 .....</b>	<b>188</b>
Follett 2 of 5 Enable/Disable .....	188
<b>BC412 .....</b>	<b>188</b>
BC412 Enable/Disable .....	188
BC412 Check Character Calculation .....	189
BC412 Length Control .....	189
BC412 Set Length 1 .....	190
BC412 Set Length 2 .....	191
<b>2D SYMBOLOGIES 193</b>	
<b>2D Global Features .....</b>	<b>193</b>
2D Maximum Decoding Time .....	194
2D Structured Append .....	195
2D Normal/Inverse Symbol Control .....	195
<b>SYMBOLOGY SELECTION 196</b>	
<b>Aztec Code .....</b>	<b>196</b>
Aztec Code Enable / Disable .....	196
Aztec Code Length Control .....	196
<b>China Sensible Code .....</b>	<b>199</b>
China Sensible Code Enable / Disable .....	199
China Sensible Code Length Control .....	199
<b>Data Matrix .....</b>	<b>202</b>
Data Matrix Enable / Disable .....	202
Data Matrix Square/Rectangular Style .....	202
Data Matrix Length Control .....	203
<b>Maxicode .....</b>	<b>205</b>
Maxicode Enable / Disable .....	205
Maxicode Primary Message Transmission .....	205
Maxicode Length Control .....	206
<b>PDF417 .....</b>	<b>208</b>
PDF417 Enable / Disable .....	208
PDF417 Length Control .....	208
<b>Micro PDF417 .....</b>	<b>211</b>
Micro PDF417 Enable / Disable .....	211
Micro PDF417 Code 128 GS1-128 Emulation .....	211
Micro PDF417 Length Control .....	212
<b>QR Code .....</b>	<b>214</b>
QR Code Enable / Disable .....	214
QR Code Length Control .....	214
<b>Micro QR Code .....</b>	<b>217</b>

Micro QR Code Enable/Disable .....	217
Micro QR Code Length Control .....	217
<b>UCC Composite .....</b>	<b>220</b>
UCC Composite Enable / Disable .....	220
UCC Optional Composite Timer .....	221
<b>Postal Code Selection .....</b>	<b>222</b>
Postnet BB Control .....	223
<b>REFERENCES.....</b>	<b>225</b>
<b>Serial Parameters .....</b>	<b>225</b>
USB COM Parameters .....	225
<b>Keyboard Interface .....</b>	<b>233</b>
Intercharacter Delay .....	233
Intercode Delay .....	234
<b>Data Format .....</b>	<b>235</b>
Data Editing .....	235
Global Prefix/Suffix .....	236
Global AIM ID .....	237
Label ID .....	238
Character Conversion .....	242
<b>Reading Parameters .....</b>	<b>243</b>
RGB LED Features .....	243
<b>Scanning Features .....</b>	<b>246</b>
Scan Mode .....	246
Scanning Active Time .....	246
<b>Symbologies .....</b>	<b>248</b>
Set Length .....	248
<b>WIRELESS FEATURES 251</b>	
<b>TECHNICAL SPECIFICATIONS.....</b>	<b>271</b>
<b>LED and Beeper Indications .....</b>	<b>275</b>
Programming Mode .....	276
<b>Base Station Indications .....</b>	<b>277</b>
<b>STANDARD DEFAULTS.....</b>	<b>279</b>
Default Exceptions .....	287
<b>SAMPLE BARCODES .....</b>	<b>291</b>
<b>KEYPAD.....</b>	<b>295</b>
<b>SCANCODE TABLES.....</b>	<b>297</b>
<b>Control Character Emulation .....</b>	<b>297</b>
Single Press and Release Keys .....	297
<b>Interface Type PC AT PS/2 or USB-Keyboard .....</b>	<b>298</b>
<b>Interface Type PC AT PS/2 Alt Mode or USB-Keyboard Alt Mode .....</b>	<b>300</b>
<b>Microsoft Windows Codepage 1252 .....</b>	<b>302</b>
<b>Index .....</b>	<b>301</b>





# Chapter 1

## Introduction

### About the Scanner

The RIDA DBT6400 by Datalogic is a Bluetooth Companion reader (2D Imager) that enables real-time barcode scanning into any Bluetooth ready device including Android, iOS and Windows.

Thanks to its extremely reduced size, the DBT6400 fits easily into a pocket and is the ideal choice for applications like field sales and service, inventory management, retail point-of-sale (POS), Healthcare and many more.

The attractive design and the light weight that characterize the DBT6400 allow the scanner to be easily worn around the user's neck with the lanyard supplied or clipped in a pocket.

Datalogic's exclusive patented 'Green Spot' for good read feedback helps to improve productivity in noisy environments or in situations where silence is required.

The RIDA DBT6400 has several customizable features:

- the reader's attractive illumination changes color to indicate its status and can be personalized by the user.
- the option to use personal jingles (a short userdefined tune uploaded via Datalogic Aladdin™ configuration software) instead of the normal beep tone.

The RIDA DBT6400 can be used with his Bluetooth base station BC6020. The base station can be used for placement of the DBT6400 allowing for charging and Host wired connection.

### Using the RIDA DBT6400

The RIDA DBT6400 normally functions by capturing and decoding codes. The aiming system is activated on trigger pull and indicates the center of the field of view which should be positioned over the barcode:

#### Aiming System

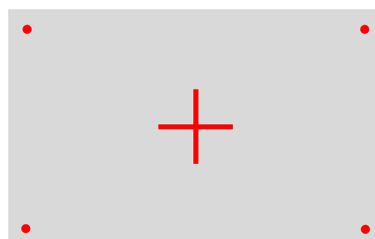

### Relative Size and Location of Aiming System Pattern

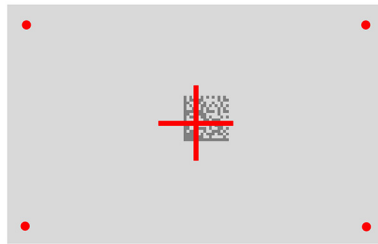

2D Matrix symbol

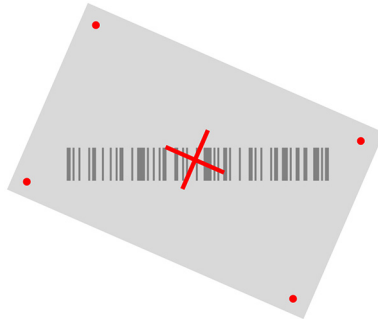

Linear barcode

A beam illuminates the label. The projected pattern of the aiming system will be smaller when the reader is closer to the barcode and larger when it is farther from the code. Symbologies with smaller bars or elements (mil size) should be read closer to the unit. Symbologies with larger bars or elements (mil size) should be read farther from the unit.

If the aiming system is centered you will get a good read. Successful reading is signaled by an audible tone plus a good read green spot LED indicator.

### Relative Size and Location of Green Spot

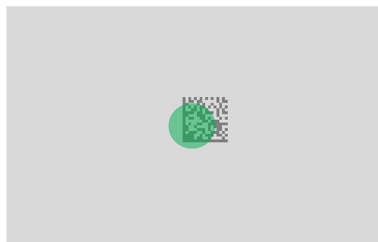

---

## About this Manual

This Product Reference Guide (PRG) is provided for users seeking advanced technical information, including connection, programming, maintenance and specifications. The Quick Reference Guide (QRG) and other publications associated with this product are downloadable free of charge from the website listed on the back cover of this manual.

Typically, units are factory-programmed for the most common terminal and communications settings. If you need to modify any programmable settings, custom configuration can be accomplished by scanning the programming barcodes within this guide.

Programming can alternatively be performed using the Datalogic Aladdin™ Configuration application, which is available from the Datalogic website listed on the back cover of this manual. This multi-platform utility program allows device configuration using a PC. It communicates to the device using a serial or USB cable and can also create configuration barcodes to print.

## Overview

[Chapter 1, Introduction](#) provides a product overview, unpacking instructions, and cable connection information.

[Chapter 2, Setup](#) presents information about unpacking and setting up the scanner, and interface configuration barcodes and details.

[Chapter 3, Configuration Using barcodes](#) provides instructions and barcode labels for customizing your scanner. There are different sections for interface types, general features, data formatting, and symbology-specific features.

[Chapter 4, References](#) provides details concerning programmable features.

[Appendix A, Technical Specifications](#) lists physical and performance characteristics, as well as environmental and regulatory specifications. It also provides standard cable pin-outs and descriptions of the functions and behaviors of the scanner's LED and Speaker indicators.

[Appendix B, Standard Defaults](#) references common factory default settings for scanner features and options.

[Appendix C, Sample barcodes](#) offers sample barcodes of several common symbolologies.

[Appendix D, Keypad](#) includes numeric barcodes to be scanned for certain parameter settings.

[Appendix E, Scancode Tables](#) lists control character emulation information for Wedge and USB Keyboard interfaces.

## Manual Conventions

The symbols listed below are used in this manual to notify the reader of key issues or procedures that must be observed when using the scanner:



**NOTE**

**Notes contain information necessary for properly diagnosing, repairing and operating the scanner.**



The CAUTION symbol advises you of actions that could damage equipment or property.

## Technical Support

### Datalogic Website Support

The Datalogic website ([www.datalogic.com](http://www.datalogic.com)) is the complete source for technical support and information for Datalogic products. The site offers product support, warranty information, product manuals, product tech notes, software updates, demos, and instructions for returning products for repair.

### Reseller Technical Support

An excellent source for technical assistance and information is an authorized Datalogic reseller. A reseller is acquainted with specific types of businesses, application software, and computer systems and can provide individualized assistance.

### Telephone Technical Support

If you do not have internet or email access, you may contact Datalogic technical support at (541) 349-8283 or check the back cover of your manual for more contact information.

**Current versions of the Product Reference Guide (PRG), Quick Reference Guide (QRG), the Datalogic Aladdin™ Configuration application, software/firmware and any additional manuals, instruction sheets and utilities for this product can be downloaded from the website listed on the back cover of this manual.**

**Alternatively, printed copies or product support CDs may be purchased through your Datalogic reseller.**



## Chapter 2 Setup

### Unpacking

Check carefully to ensure the scanner and any cables or accessories ordered are present and undamaged. If any damage occurred during shipment, contact Technical Support on page 4.

KEEP THE PACKAGING. Should the unit ever require service, it should be returned in its original shipping container.

### Setting Up the Reader

Follow the steps below to connect and get your reader up and communicating with its Host.

1. Configure the Base Station (if available)
2. Charge the Batteries (see "Charging the Batteries" on page 7).
3. Link to a Host (see "Linking to a Host" on page 9) or to the Base Station (if available – see "Linking to a Base Station" on page 11).
4. Select the Interface Type for Base Station.
5. Configure the Reader (optional, depends on settings needed).

### Configuring the BC6020 Base Station

Place the RIDA scanner on the Base Station as shown in the figure below.

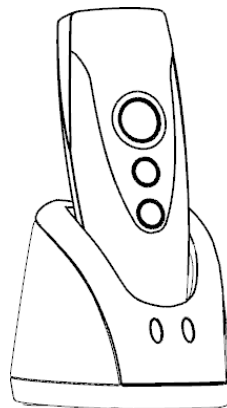

The Base Station can be powered up by an external power supply or by a Host via the micro USB Cable. Both the power cable and the micro USB cable can be connected at the same time on the Base; in this case, USB connection is used for data exchange with the Host, while power is supplied from external power supply.

The figure below shows how to connect the Base Station to a terminal PC or to another Host device.

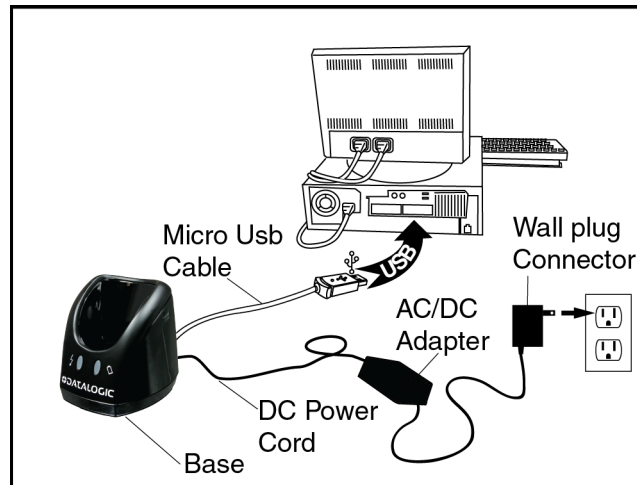

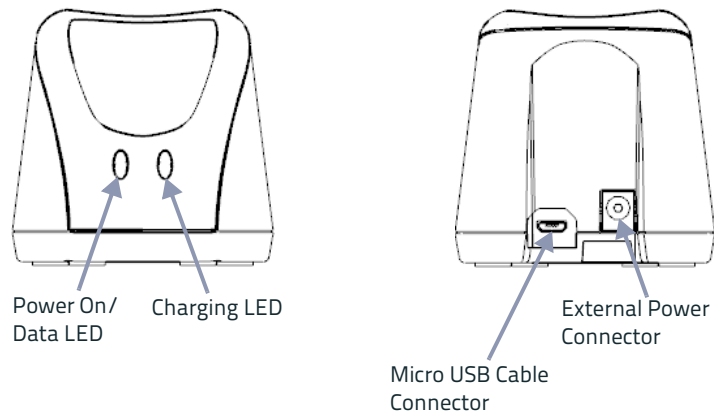

## Using the BC6020 Base Station

LEDs on BC6020 Base Station provide information about the Base as well as the battery charging status, as shown in the figure below.



The behaviour and meaning of the LEDs are summarized in Table 1:

**Table 1. Radio Base LEDs**

	LED	Status
	Power On/ Data	Yellow On = base is powered. Yellow Blinking = base receives data and commands from the Host or the reader.
	Charging+Charge completed	Green On = Power provided to the scanner for battery charging. Charging indications are shown by the scanner.

## Charging the Batteries

Before using the DBT6400 for the first time, it is necessary to charge the battery.

The battery can be charged by connecting the reader directly to a Host through the micro-USB connector. You can use the provided USB cable for this purpose.

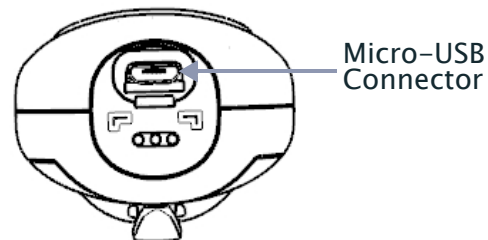

Alternatively, the battery can be charged using:

1. the Base Station BC6020.
2. the charging-only cradle CHR-DBT60, available as an optional.

To charge the battery with the Base Station, insert the reader into the base. When the scanner detects the base it will sound to indicate the correct placement.

When in charge, the side LEDs on the reader indicate the status of the battery. If the battery is very depleted, the reader could stay in a precharge phase with the top led blinking red. This phase automatically ends when the battery charge is enough to power up the reader, in case the battery charging is not completed.

Battery charging indications are shown on the side band LEDs. While charging, the side band LEDs blink green; when the battery is fully charged, the side band LEDs remain solid green.



**NOTE**

Before using the Battery, read "Battery Safety" in the Safety and Regulatory Addendum. Datalogic recommends annual replacement of rechargeable battery packs to ensure maximum performance.

## Replacing the Battery Pack



Before proceeding, read "Battery Safety" in the Safety and Regulatory Addendum. Datalogic recommends annual replacement of rechargeable battery packs to ensure maximum performance.

1. Use a T5 type screwdriver to unscrew the cover of the battery pack until it is disengaged.

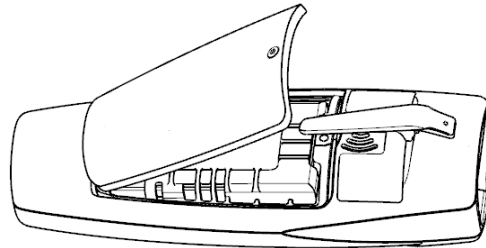

2. Pull up the battery pack and disconnect the cable from the battery connector. For this operation you can use a plastic nipper. If under the battery there is any label that covers the battery connector, remove it.

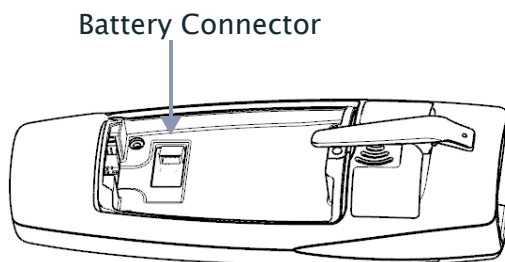

To mount the new battery pack reverse the process. Restore the label under the battery if it was present. Use the new one included in battery spare part.



## Linking to a Host

The RIDA DBT6400 is equipped with Bluetooth® Wireless Technology. To set up the scanner for communication with a Host the user shall select the Profile Mode.

The available Profile Mode for standard Bluetooth are:

- Bluetooth Serial Port Profile (SPP)
- Bluetooth HID Profile (default)

Scan one of the following barcodes to select the desired Profile Mode:



Link to Host in SPP mode



Link to Host in HID mode

After reading one of the above profile label, the scanner, if already connected to a Host, will unlink.



**NOTE**

If the profile label is read when the reader is already connected to a Host, the scanner will first unlink and then apply the new profile.

After reading the profile label the scanner will become discoverable by the Host.

## Bluetooth Pairing

To pair with a Bluetooth enabled Host:

1. Press the scan button to wake up the reader.
2. Press the Link button. The blue LED blinking indicate that the scanner is discoverable by the Host. Alternatively, you can read one of the profile labels (see "Linking to a Host" on page 9) and the reader will become automatically discoverable by the Host.
3. On the Host, use the dedicated Bluetooth application to search for new devices. Select the RIDA scanner from the list of available devices. If you receive an error message, it may be necessary to disable security on the device.
4. When the scanner ends the pairing with the Host the blue LED remains on. Depending on the Bluetooth profile, you can check the connection:
  - A. For SPP: use an RS-232 terminal program to see incoming data on the port designated by the Host Bluetooth application (Bluetooth outgoing COM port).
  - B. For HID: use a text editor to see incoming data on the Host.



The DBT6400 reader can be set up to require a PIN code when connecting. If you want to set up a PIN, or add new equipment to a system that uses a custom security PIN, please see "BT Security Features" on page 262.

## Bluetooth Unpairing

To unpair the reader and the Host, press and hold the Link button until the blue LED turns off.

Alternatively, read the following unlink label.

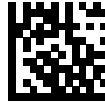

Unlink



Before pairing to another Host, the reader must be unpaired from the previous.

## Bluetooth Passkey Request

During the pairing process, based on Host and Reader security settings, you may need to enter a passkey.

If you let the Host generate the passkey, simply enter the required code by scanning the corresponding barcodes for alphanumeric entry. Complete by scanning the **End** label. To restart the entering of the passkey, read the **Restart** label. To abort entering of passkey read **Abort**.

If, alternatively, you choose to enter on the Host the passkey proposed by the Reader, enter 1234.

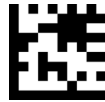

Passkey END



Passkey Restart



Passkey Abort

## HID Country Mode

When the Reader is connected with a Bluetooth Application in HID mode, you may want to set the country for which your Host is localized. Go to "HID Country Mode" on page 266" and read one of the configuration command labels.

## Linking to a Host in Initiator Mode

The reader can optionally be linked to a host as initiator (also called Client Mode or Master Mode). This kind of link can be done in all the available profiles. To do this, follow these steps:

1. Ensure the host is powered and has the Bluetooth feature enable.
2. Identify the Bluetooth address in the Host/adaptor device.
3. Create a Link label that contains the address of the Host/adaptor. The link label is a Code 128 function 3 label having the following format for SPP connection:  
**<FN3 char>LnkB<12 character Bluetooth address>**  
 And the following format for HID connection:  
**<FN3 char>LnkHid<12 character Bluetooth address>**
4. Scan the link label you created in step 3.
5. Complete the procedure to establish the connection. For the SPP mode you need to open the associated incoming COM port.

Example: if you want to connect to a tablet with BT Address 00:1A:7D:DA:71:13 the label content in order to connect in SPP profile is:

**<FN3 char>LnkB001A7DDA7113**

To connect in HID profile:

**<FN3 char>LnkHid001A7DDA7113.**



**NOTE**

To easily switch between different Host is suggested to keep default security level.



**NOTE**

Note: Some Host cannot accept connection using HID profile in initiator mode.

## Linking to a Base Station

The RIDA DBT6400 can be used paired with its Base Station. The data received over the RF link will be exchanged with the Host using the USB interface of the Base Station. In this case, before configuring the interface, it is necessary to link the scanner to the Base Station.

To link the handheld and the base, press the Scan button to wake up the reader and then insert the reader into the Base station. A beep will indicate the successful pairing.

If the reader was previously linked to another base or host, you must first scan the Unlink barcode before linking to the new base.



Unlink

## Base Station Interface Selection

Upon completing the physical connection between the base and its host, proceed directly to Interface Selection to select the kind of USB interface type the base is connected to; scan the appropriate barcode for your system's interface type.

The base will support the following USB host interfaces:

- USB COM to simulate RS-232 standard interface
- USB-OEM (can be used for OPOS/UPOS/JavaPOS)
- USB Keyboard
- USB Composite (KEYBOARD + COM)

For defaults and additional information associated with each interface, proceed to the corresponding chapter in the Product Reference Guide.





## Configuring the Interface

Scan the programming barcode which selects the appropriate interface type for the system the reader will be connected to.



**NOTE**

Unlike some other programming features and options, interface selections require that you scan only one programming barcode label. DO NOT scan an ENTER/EXIT barcode prior to scanning an interface selection barcode.

USB INTERFACES
<p>USB COM to simulate RS-232 standard interface</p>  <p>Select USB-COM-STD<sup>a</sup></p>
<p>USB-OEM (can be used for OPOS/UPOS/JavaPOS)</p>  <p>Select USB-OEM</p>
<p>USB Keyboard</p>  <p>Select USB Keyboard</p>
<p>USB Composite</p>  <p>Select USB Composite<sup>a</sup></p>

a. Download the correct USB COM driver from [www.datalogic.com](http://www.datalogic.com).

---

# Customizing Configuration Settings

## Using the Programming barcodes

This manual contains feature descriptions and barcodes which allow you to reconfigure your scanner. Some programming barcode labels, like "Resetting the Product Configuration to Defaults" on page 15, require only the scan of that single label to enact the change. Most of the programming labels in this manual, however, require the scanner to be placed in Programming Mode prior to scanning them. Scan an ENTER/EXIT barcode once to enter Programming Mode. Once the scanner is in Programming Mode, you can scan a number of parameter settings before scanning the ENTER/EXIT barcode a second time, which will then accept your changes, exit Programming Mode and return the scanner to normal operation.



**NOTE**

There are some exceptions to the typical programming sequence described above. Please read the description and setting instructions carefully when configuring each given programmable feature.

## Datalogic Aladdin™ Utility

Programming can alternatively be performed using the Datalogic Aladdin™ Configuration application which is available for free download from the Datalogic website listed on the back cover of this manual. This multi-platform utility program allows device configuration using a PC. It communicates to the device using a serial or USB cable and can also create configuration barcodes to print.

Datalogic Aladdin™ is a multi-platform utility program providing a quick and user-friendly configuration method via the RS-232/USB-COM interface. The Aladdin utility is available on the Datalogic website. Aladdin allows you to program the scanner by selecting configuration commands through a user-friendly graphical interface running on a PC. These commands are sent to the scanner over the selected communication interface, or they can be printed as barcodes to be scanned.

Aladdin also provides the ability to perform a software upgrade for the connected device (see the Datalogic Aladdin™ Help On-Line for more details).

## Interface Settings

The scanner and the base station (if available) are typically factory-configured with a set of default features standard to the interface type you ordered. See "Base Station Interface Selection" on page 12.

Global Interface Features, starting on page 23 provides settings configurable by all base station interface types. If your installation requires you to further customize your scanner, you can select other options through use of the instructions and programming barcodes available in the appropriate section for your interface.

- USB-COM Interfaces, starting on page 25
- Keyboard Interface, starting on page 35
- USB-OEM Interface, starting on page 65

## Configuring Other Features

If your installation requires different programming than the standard factory default settings, the following sections of this manual allow configuration of non-interface-specific settings you might require:

**Configuration Using barcodes:** General Features includes programming for scanning, speaker and LED indicators and other such universal settings.

**Reading Parameters:** Reading Parameters include programming for scanning, speaker and LED indicators and other universal settings.

**1D Symbologies:** Includes options concerning the barcode label types (symbologies). These settings allow you to enable/disable symbologies, set label lengths, require check digit, etc.

## Software Version Transmission

The software version of the device can be transmitted over the wireless BT Scanner Profile interfaces or the USB Base Station interfaces by scanning the following label.



Transmit Software Version

## Resetting the Product Configuration to Defaults

If you aren't sure what programming options are in your scanner, or you've changed some options and want to restore the Custom Default Configuration that may have been saved in the scanner, scan the [Restore Custom Default Configuration](#) barcode below. This will restore the custom configuration for the currently active interface.



### NOTE

Custom defaults are based on the interface type. Configure the scanner for the correct interface before scanning this label.



Restore Custom Default Configuration

If you aren't sure what programming options are in your scanner, or you've changed some options and want to restore the Factory Configuration, you have two options. You can scan the [Restore USA Factory Configuration](#) barcode or the [Restore EU Factory Configuration](#) barcode below. Both labels restore the scanner configuration to the factory settings including the interface type. The USA label restores Label IDs to those historically used in the USA. The EU label restores Label IDs to those historically used in Europe. The Label ID sets for USA and EU are shown in the Label ID section of this manual.



### CAUTION

Scanning either of the "Restore Factory Configuration" commands below will result in the loss of any custom configuration settings for your device.



Restore USA Factory Configuration



Restore EU Factory Configuration

The programming section on the following pages lists the factory default settings for each of the menu commands (indicated by shaded blocks and bold text).

## Compatibility

### Supported BT Specification

The Rida Bluetooth radio is fully compatible with the following Bluetooth specifications:

- Bluetooth v2.1 + EDR
- Bluetooth v3.0 + HS
- Bluetooth v4.0
- Bluetooth v4.1

For more details on connection with devices compliant with older BT specifications, please refer to the PRG.

### Device and operative system supported

In general, the Rida supports connection with devices and Bluetooth radio stacks compliant with the above specifications (see "Supported BT Specification" on page 16) that are able to support HID Host and/or SPP profile.

This is a non-exhaustive list of supported operating systems:

- iOS
- Android
- Windows (7, 8, 8.1, 10)
- Windows XP (Microsoft, Broadcom, and other commonly available Bluetooth stacks)
- Windows Phone 8.1 Update 2 (only for HID profile)
- Windows 10 Mobile
- Mac OS X 10.11

Note that:

- Windows XP Service Pack 2 and SP3 releases work natively with Bluetooth v1.1, v2.0 and v2.0+EDR. To connect with Rida, the Windows XP stack must be replaced by a third party stack that supports newer Bluetooth versions.
- Windows 7 works with Bluetooth v2.1+EDR. Bluetooth stack supports vendor-supplied additional profiles without requiring that the Microsoft stack be replaced. Due to the driver stack, used passkey could be required during pairing process.



## Tested Devices

This is a non-exhaustive list of tested devices:

Type	Device	Note
<b>Laptop</b>	HP EliteBook 8460p	Windows 7, built in BT radio (WID-COMM BT Stack)
	HP EliteBook 8460p	Windows 7, native BT Software Stack
	MacBook Air 2015	Mac OS X 10.11, built in BT radio
	Dell Latitude E7450	Windows 7, built in BT radio
<b>Tablet and Smartphone</b>	iPad Mini 4	iOS9
	iPhone 3Gs	iOS 6
	Motorola Nexus 6	Android 6.0
	Samsung Galaxy Tab S SMT805	Android 5.0
	Huawei Honor 4C	Android KitKat
	NOKIA LUMIA 640 XL	Windows Phone 8.1 Update 2
	Samsung Galaxy S5 (SM-G900F)	Android 6.0.1
<b>Dongle</b>	Sitecom Usb Adapter Bluetooth 4.0	CSR Harmony Wireless Software Stack on Windows 7
	Sitecom Usb Adapter Bluetooth 4.0	Windows 7 native BT Software Stack

For an updated list, please refer to the company website.

## Cleaning Procedure

Proper cleaning is needed on the external plastic surfaces, output window and electrical contacts to guarantee reliable scanning and charging of the battery.

A regular cleaning routine will remove the dust and dirt that may accumulate on the product over time. The maintenance activity may be repeated more frequently depending on the severity of the environment in which the scanner is used.

A periodic deeper cleaning is suggested once per month.

### Cleaning plastic surfaces

Exterior plastic surfaces and scan windows exposed to spills, smudges or debris require periodic cleaning to ensure best performance during scanning. Use a soft, dry cloth to clean the product.

If the product is very soiled, clean the plastic surfaces with a soft cloth moistened with a diluted non-aggressive cleaning solution or isopropyl alcohol (minimum 70%).

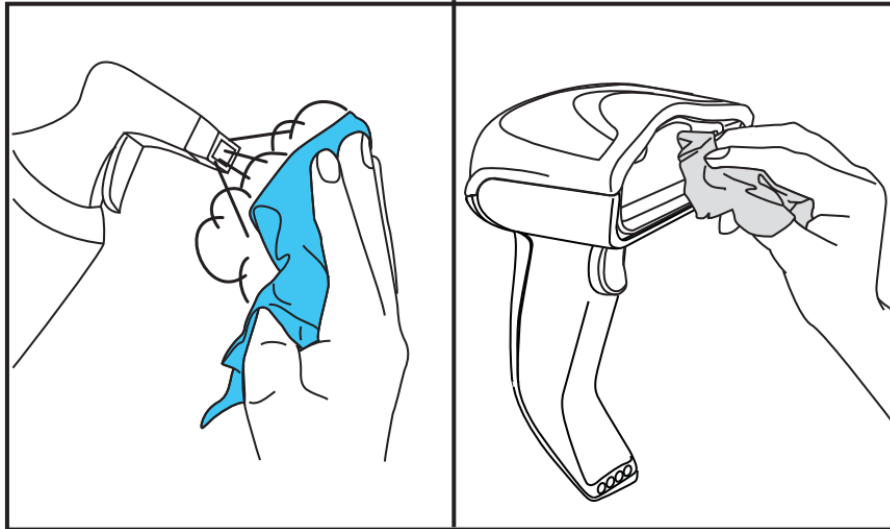

Recommended cleaners for standard plastics are:

Formula 409® glass and surface cleaner, dish soap and water, Windex® Original (Blue).

Recommended cleaners for Health care plastics:

CaviWipes™, diluted Clorox® bleach, Hepacide Quat® II, Sani-Cloth®, Virex® II 256.



#### CAUTION

Do not use abrasive or aggressive cleansing agents or abrasive pads to clean scan windows, contacts or plastics.

Do not spray or pour liquids directly onto the unit.

Be sure to turn off power and unplug the device from electrical outlet before cleaning.

Be sure to dry up the device before powering it up.

Cleaner and liquids may be harsh on metal contacts. They are recommended for use only on enclosures.

## Cleaning electrical contact surfaces

Regular cleaning of electrical contacts is needed to guarantee a correct recharging of the battery. Both scanner and cradle contacts should be cleaned. In case spills, smudges or debris accumulate on the cradle and/or the scanner, proper operation could be affected and a periodical cleaning is recommended as follows.

Avoid the use of brushes or any other hard tool to remove grime from electrical contacts, since these may damage or scratch the contact's plating.

### Scanner Contacts

- Use a soft dry cloth to clean the contact area and the plastic surface around the contacts.
- Be sure to remove dust, dirt and any cloth residue.
- If the level of grime is significant, it is suggested the use of a soft white or pink pencil eraser to gently rub the contacts. Motion can be along both the green and yellow directions.

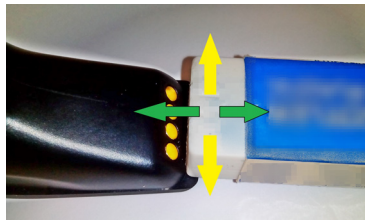

- Be sure to remove the rubber residuals by gently blowing them off with clean compressed air.



**CAUTION**

Be careful when using compressed air: protect yourself with goggles and point the nozzle far from eyes and not too close to the scanner surface. Read previously the warning label on the spray can.

### Cradle Contacts

- Use a soft dry cloth to clean the contact area and the plastic surface around the contacts.
- Particular attention must be paid to remove dust, dirt and any cloth residue. Do not allow this material to fall again onto the contacts.
- It is suggested the use of a soft white or pink pencil eraser to gently rub the contacts. Cradle contacts should be cleaned with a motion along the yellow direction.

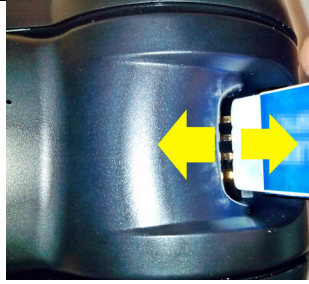

- Be sure to remove the rubber residuals by gently blowing them off with clean compressed air.

## Scanner and cradle deep cleaning

In case some hard grime, grease or liquid residual are present on electrical contacts, a deeper cleaning may be needed. If the above procedure is not enough to guarantee proper working of the system, the use of isopropyl alcohol is suggested (minimum 70%).

In this case it is suggested to use a cotton tipped applicator with isopropyl alcohol, gently wiping along the pins of the electrical connection. Be sure that cotton residue is not left on any pin of the electrical contacts.



**Remove power before initiating the deep cleaning routine.**

**After completion of the deep cleaning routine allow the system to dry completely before reconnecting to power. Depending on the environmental conditions wait at least 30 minutes or, if possible, leave the system unpowered overnight.**



## Chapter 3

# Configuration Using barcodes

This and following sections provide programming barcodes to configure your scanner by changing the default settings. For details about additional methods of programming, see "Customizing Configuration Settings" on page 13.



### NOTE

You must first enable your scanner to read barcodes in order to use this section. If you have not done this, go to Setup, starting on page 5 and complete the appropriate procedure.

## Configuration Parameters

Once the scanner is set up, you can change the default parameters to meet your application needs. Refer to "Resetting the Product Configuration to Defaults" on page 15 for initial configuration in order to set the default values and select the interface for your application.

The following configuration parameters are divided into logical groups, making it easy to find the desired function based on its reference group.

### Interface Configuration:

- "USB-COM Interfaces" on page 25
- "Keyboard Interface" on page 35
- "USB-OEM Interface" on page 65

### Parameters common to all interface applications:

- "Global Prefix/Suffix" on page 68
- "Data Format" on page 67 offers advanced configuration options for customization of scanned data output.
- "Reading Parameters" on page 79 control various operating modes and indicators status functioning.

### Symbology-specific parameters:

"1D Symbologies" on page 105 defines options for all symbologies and provides the programming barcodes necessary for configuring these features.



### NOTE

You must first enable your scanner to read barcodes in order to use this section. If you have not done this, go to Setup, starting on page 5 and complete the appropriate procedure.



**To program features:**

1. Scan the ENTER/EXIT PROGRAMMING barcode, available at the top of each programming page, when applicable.
2. Scan the barcode to set the desired programming feature. You may need to cover unused barcodes on the page, and possibly the facing page, to ensure that the scanner reads only the barcode you intend to scan.
3. If additional input parameters are needed, go to [Appendix D, Keypad](#), and scan the appropriate characters from the keypad.



**NOTE**

**Additional information about many features can be found in the "References" chapter.**

**If you make a mistake before the last character, scan the CANCEL barcode to abort and not save the entry string. You can then start again at the beginning.**

4. Complete the programming sequence by scanning the ENTER/EXIT PROGRAMMING barcode to exit Programming Mode.

For more detailed descriptions, programming information and examples for setting selected configuration items, see [References, starting on page 235](#).



## Global Interface Features

The following interface features are configurable by all interface types. To set features specific to your interface, turn to that section of this manual.

**HOST COMMANDS — OBEY/IGNORE on page 23**

**USB SUSPEND MODE on page 24**

### Host Commands — Obey/Ignore

This option specifies whether the scanner will obey or ignore host commands. When set to ignore, the scanner will ignore all host commands except for those necessary for:

- service mode
- flash programming mode
- keeping the interface active
- transmission of labels.

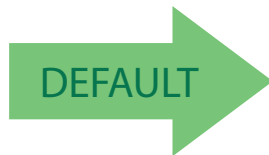

Host Commands = Obey



Host Commands = Ignore



Enter/Exit Programming Mode

---

## USB Suspend Mode

This setting enables/disables the ability of the USB interface to enter suspend mode.

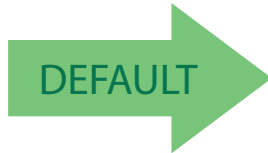

USB Suspend Mode = Disable



USB Suspend Mode = Enable





## USB-COM Interfaces

The programming barcodes in this chapter allow modifications to the standard RS-232 / USB-Com interfaces.

<b>STANDARD FACTORY SETTINGS</b> on page 25
<b>INTERCHARACTER DELAY</b> on page 26
<b>BEEP ON ASCII BEL</b> on page 27
<b>BEEP ON NOT ON FILE</b> on page 27
<b>ACK NAK OPTIONS</b> on page 28
<b>ACK CHARACTER</b> on page 29
<b>NAK CHARACTER</b> on page 29
<b>ACK NAK TIMEOUT VALUE</b> on page 30
<b>ACK NAK RETRY COUNT</b> on page 31
<b>ACK NAK ERROR HANDLING</b> on page 32
<b>INDICATE TRANSMISSION FAILURE</b> on page 33
<b>DISABLE CHARACTER</b> on page 33
<b>ENABLE CHARACTER</b> on page 34

### Standard Factory Settings

Reference [Appendix B](#), for a listing of standard factory settings.



## Intercharacter Delay

This parameter specifies the intercharacter delay between the end of one character and the beginning of the next. The delay can be set within a range of zero (0) to 990 milliseconds in 10ms increments. A setting of zero specifies no delay. See "Label ID: Pre-loaded Sets" on page 238 for more detailed programming instructions.



Intercharacter Delay = No Delay



Select Intercharacter Delay Setting

To configure this feature, scan the ENTER/EXIT barcode above, then the barcode at left followed by digits from the Alphanumeric characters in [Appendix D, Keypad](#) representing your desired character(s). End by scanning the ENTER/EXIT barcode again.

Make a mistake? Scan the CANCEL barcode to abort and not save the entry string. You can then start again at the beginning.

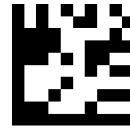

CANCEL

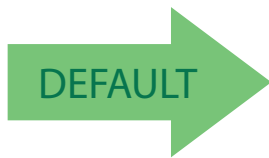

**00 = No Intercharacter Delay**

## Beep On ASCII BEL

When this parameter is enabled, the scanner issues a beep when a <BEL> character is detected on the RS-232 serial line. <BEL> is issued to gain a user's attention to an illegal entry or other important event.



## Beep On Not on File

This option enables/disables the action of the scanner to sound a three beep sequence upon receiving a Not-On-File (NOF) host command.

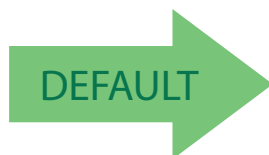



## ACK NAK Options

This enables/disables the ability of the scanner to support the RS-232 ACK/NAK protocol. When configured, the scanner and/or host sends an “ACK” when it receives data properly, and sends “NAK” when the data is in error.

Options are:

- Disable
- Enable for label transmission — The scanner expects an ACK/NAK response from the host when a label is sent.
- Enable for host-command acknowledge — The scanner will respond with ACK/NAK when the host sends a command.
- Enable for label transmission and host-command acknowledge

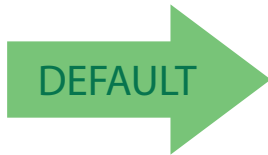

ACK/NAK Protocol = Disable ACK/NAK



ACK/NAK Protocol = Enable for label transmission



ACK/NAK Protocol = Enable for host-command acknowledge



ACK/NAK Protocol = Enable for label transmission and host-command acknowledge

## ACK Character

This setting specifies an ASCII character or hex value to be used as the ACK character. ASCII characters or any hex value from 0 to 0xFF can be selected. See "ACK Character" on page 227 for more detailed programming instructions.



**NOTE**

Setting to previously defined characters such as XON, XOFF, or host commands conflicts with normal operation of these characters.



Select ACK Character Setting

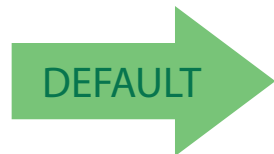

**0x06 'ACK' Character**

## NAK Character

This setting specifies an ASCII character or hex value to be used as the NAK character. ASCII characters or any hex value from 0 to 0xFF can be selected. See "NAK Character" on page 227 for more detailed programming instructions.



**NOTE**

Setting to previously defined characters such as XON, XOFF, or host commands conflicts with normal operation of these characters.



Select NAK Character Setting

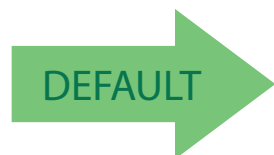

**0x15 'NAK' Character**



## ACK NAK Timeout Value

This option specifies the amount of time the scanner waits for an ACK character from the host following label transmission. The selectable timeout range is 200 milliseconds to 15,000ms (15 seconds) in 200ms increments. A selection of 0 disables the timeout. See "ACK NAK Timeout Value" on page 229 for more detailed programming instructions.



Select ACK NAK Timeout Value Setting

To configure this feature, scan the ENTER/EXIT barcode above, then the barcode at left followed by digits from the Alphanumeric characters in [Appendix D, Keypad](#) representing your desired character(s). End by scanning the ENTER/EXIT barcode again.

Make a mistake? Scan the CANCEL barcode to abort and not save the entry string. You can then start again at the beginning.

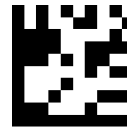

CANCEL

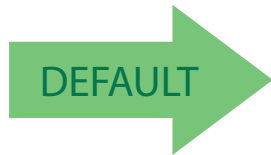

**01 ACK NAK Timeout value is 200ms**



## ACK NAK Retry Count

This feature specifies the number of times the scanner retries a label transmission due to a retry condition. The selectable range is from 1 to 254 retries. A selection of 0 disables the count, and a selection of 255 specifies unlimited retries. See "ACK NAK Retry Count" on page 230 for more detailed programming instructions.



Select ACK NAK Retry Count Setting

To configure this feature, scan the ENTER/EXIT barcode above, then the barcode at left followed by digits from the Alphanumeric characters in [Appendix D, Keypad](#) representing your desired character(s). End by scanning the ENTER/EXIT barcode again.

Make a mistake? Scan the CANCEL barcode to abort and not save the entry string. You can then start again at the beginning.

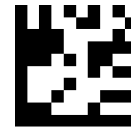

CANCEL

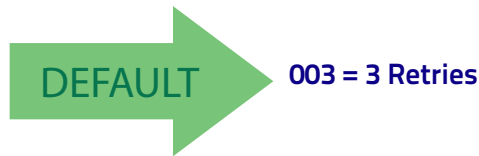



## ACK NAK Error Handling

This feature specifies the method the scanner uses to handle receive errors detected while waiting for an ACK character from the host.

Options are:

- Ignore errors detected
- Process error as valid ACK character
- Process error as valid NAK character

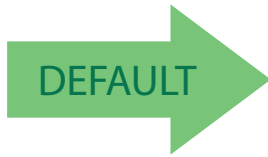

ACK NAK Error Handling = Ignore Errors Detected



ACK NAK Error Handling = Process Error as Valid ACK Character



ACK NAK Error Handling = Process Error as Valid NAK Character





## Indicate Transmission Failure

This option enables/disables the scanner's ability to sound an error beep to indicate a transmission failure while in ACK/NAK mode.



Indicate Transmission Failure = Disable Indication



Indicate Transmission Failure = Enable Indication



## Disable Character

Specifies the value of the RS-232 host command used to disable the scanner. ASCII characters or any hex value from 0 to 0xFF can be selected. See "Disable Character" on page 231 for more detailed programming instructions.



**NOTE**

Setting to previously defined characters such as XON, XOFF, or host commands conflicts with normal operation of these characters.



Select Disable Character Setting

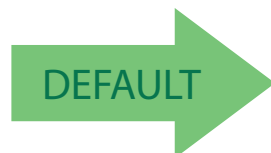

**0x44 = Disable Character is 'D'**



## Enable Character

Specifies the value of the RS-232 host command used to enable the scanner. ASCII characters or any hex value from 0 to 0xFF can be selected. See "Enable Character" on page 232 for more detailed programming instructions.



**NOTE**

Setting to previously defined characters such as XON, XOFF, or host commands conflicts with normal operation of these characters.



Select Enable Character Setting

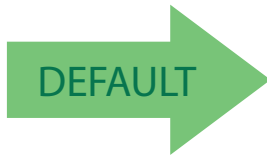

0x45 = Enable Character is 'E'

# Keyboard Interface

Use the programming barcodes in this chapter to select options for USB Keyboard. Reference [Appendix B](#), for a listing of standard factory settings. Information about control character emulation which applies to keyboard interfaces is listed in [Appendix E, Scancode Tables](#).

<b>COUNTRY MODE</b> on page 36
<b>CAPS LOCK STATE</b> on page 58
<b>NUMLOCK</b> on page 59
<b>KEYBOARD NUMERIC KEYPAD</b> on page 59
<b>KEYBOARD SEND CONTROL CHARACTERS</b> on page 60
<b>INTERCHARACTER DELAY</b> on page 61
<b>INTERCODE DELAY</b> on page 62
<b>USB KEYBOARD SPEED</b> on page 63



## Country Mode

This feature specifies the country/language supported by the keyboard. The Country Mode setting is ignored if the interface uses alternate key encoding.

### Setup on PC to use ALT Universal

1. Open Registry Edit

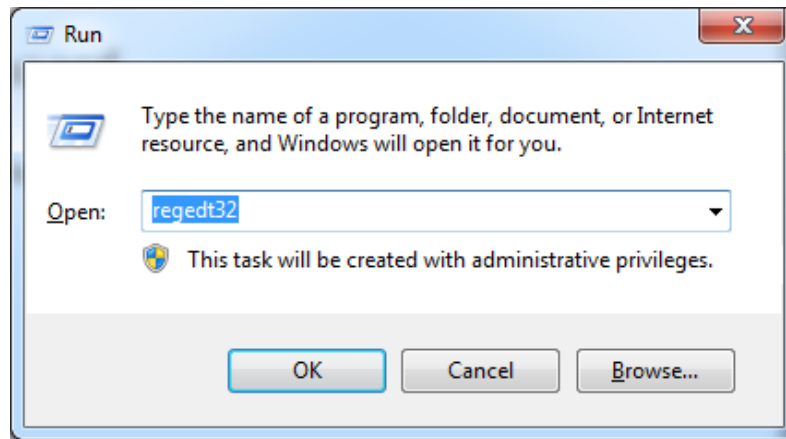

2. Set EnableHexNumpad to 1 as follows:

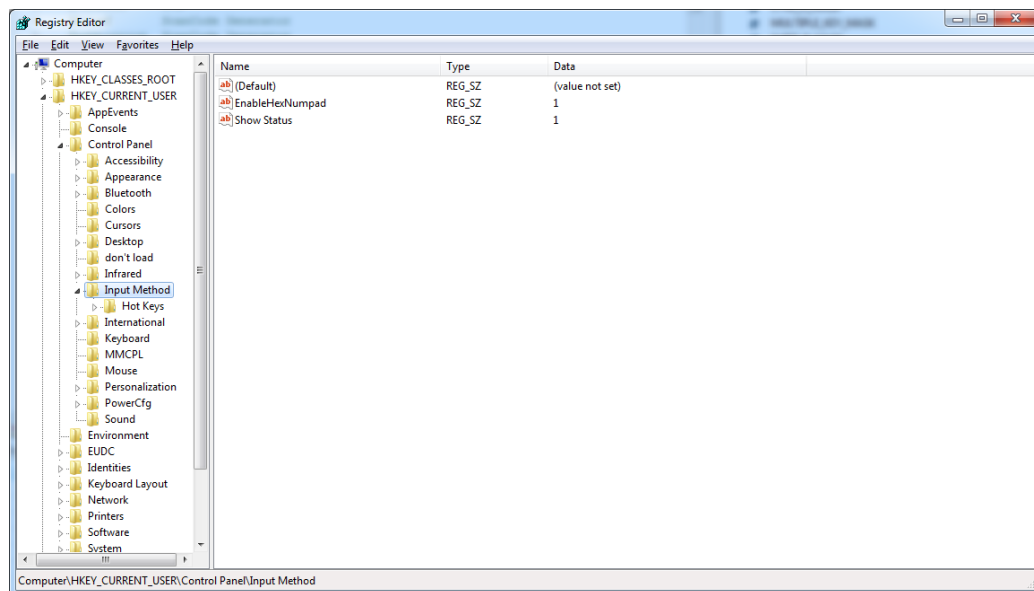

3. Reset the PC.

## Setting Country Mode

This feature specifies the country/language supported by the keyboard. Country Modes are only valid for the following interfaces:

- USB Keyboard (without alternate key encoding)
- BT HID

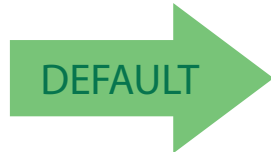

United States



French International (Belgian French)



United Kingdom



Danish



French (France)



German



Italian



---

## Setting Country Mode (continued)



Norwegian



Portuguese Portugal



Spanish



Swedish



Swiss French



Japanese ASCII



Hungarian



## Setting Country Mode (continued)



Slovak



Czech



Romanian



Croatian



Polish\_214



Canadian French Win7



Lithuanian



---

## Setting Country Mode (continued)



Vietnamese



Russian



Arabic 101



Chinese ASCII



Thai-Kedmanee



Albanian



Arabic 102





## Setting Country Mode (continued)



Arabic 102 AZERTY



Azeri Cyrillic



Azeri Latin



Belarusian



Bosnian Cyrillic



Bosnian Latin



Bulgarian Cyrillic



---

## Setting Country Mode (continued)



Bulgarian Latin



Canadian French (Legacy)



Canadian Multilingual



Chinese (Simplified)



Chinese (Traditional)



Czech Programmers



Czech QWERTY



## Setting Country Mode (continued)



Dutch Netherland



Estonian



Faeroese



Finnish



French (Canada) 2000/XP



French (Canada) 95/98



Galician



---

## Setting Country Mode (continued)



Greek



Greek Latin



Greek Polytonic



Greek220



Greek220 Latin



Greek319



Greek319 Latin



## Setting Country Mode (continued)



Hebrew Israel



Hungarian\_101KEY



Icelandic



Irish



Italian\_142



Japanese (Shift-JIS)



Kazakh



---

## Setting Country Mode (continued)



Korean (Hangul)



Korean ASCII



Kyrgyz Cyrillic



Latin America



Latvian



Latvian QWERTY



Lithuanian\_IBM



## Setting Country Mode (continued)



Macedonian -FYROM



Maltese\_47KEY



Mongolian-Cyrillic



Polish Programmer



Portuguese Brazil



Portuguese Brazilian ABNT



Portuguese Brazilian ABNT2



---

## Setting Country Mode (continued)



Romanian Legacy



Romanian Programmer



Romanian Standard



Russian Typewriter



Serbian Cyrillic



Serbian Latin



Slovak QWERTY





## Setting Country Mode (continued)



Spanish Variation



Slovenian



Swiss German



Tatar



Turkish F



Turkish Q



Ukrainian



---

## Setting Country Mode (continued)



US Dvorak



US Dvorak Left Hand



US Dvorak Right Hand



US English (Mac)



US English (North American)



US International



Uzbek Cyrillic



## Setting Encoding Type

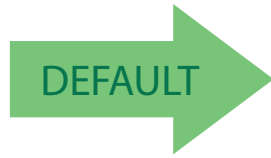

Don't use encoding



UTF\_8



Windows 874



Windows 932



Windows 936



Windows 949



Windows 950



---

## Setting Encoding Type (continued)



Windows 1250



Windows 1251



Windows 1252



Windows 1253



Windows 1254



Windows 1255



Windows 1256



### Setting Encoding Type (continued)



Windows 1257



Windows 1258



Windows 20866



ISO 8859-1



ISO 8859-2



ISO 8859-3



ISO 8859-4



---

## Setting Encoding Type (continued)



ISO 8859-5



ISO 8859-6



ISO 8859-7



ISO 8859-8



ISO 8859-9



ISO 8859-10



ISO 8859-11



## Setting Encoding Type (continued)



ISO 8859-13



ISO 8859-14



ISO 8859-15



ISO 8859-16



MS-DOS 437



MS-DOS 737



MS-DOS 775



---

## Setting Encoding Type (continued)



MS-DOS 850



MS-DOS 852



MS-DOS 855



MS-DOS 857



MS-DOS 860



MS-DOS 861



MS-DOS 862





## Setting Encoding Type (continued)



MS-DOS 863



MS-DOS 865



MS-DOS 866



MS-DOS 869



Mac CP10000



## Setting ALT output type



ALT Codepage: (use on non Unicode application: Notepad)



ALT Unicode: (use on Unicode application: Word)



DEFAULT



ALT Universal: (Use for all)

## Caps Lock State

This option specifies the format in which the scanner sends character data. This does not apply when an alternate key encoding keyboard is selected.

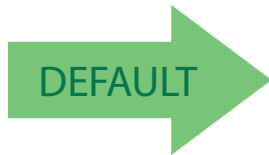

DEFAULT



Caps Lock State = Caps Lock OFF



Caps Lock State = Caps Lock ON



Caps Lock State = AUTO Caps Lock Enable

## Numlock

This option specifies the setting of the Numbers Lock (Numlock) key. This only applies to alternate key encoding interfaces.

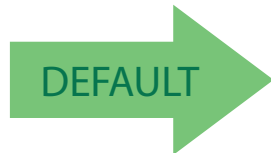

Numlock = Numlock key unchanged



Numlock = Numlock key toggled

## Keyboard Numeric Keypad

This feature specifies if numeric characters will be sent using the standard keys or the numeric keypad.

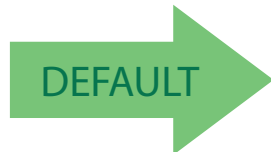

Keyboard Numeric Keypad = Standard Keys



Keyboard Numeric Keypad = Numeric Keypad



## Keyboard Send Control Characters

This feature specifies how the scanner transmits ASCII control characters to the host. Reference [Appendix E, Scancode Tables](#) for more information about control characters.

Options are as follows:

**Send Ctrl+Key :** ASCII characters from 00H to 0x1FH inclusive are transmitted in the format Ctrl+Key. Special keys are available in the range from 81H to A1.

**Send Ctrl+Shift+Key :** The behavior is the same as above, but control keys are sent in the format Ctrl+Shift+Keys.

**Send Special Function Key :** Send characters between 00H and 1FH according to the special function key mapping table (see "[Interface Type PC AT PS/2 Alt Mode or USB–Keyboard Alt Mode](#)" on page 300). This is used to send keys that are not in the normal ASCII set. A unique set is provided for each available scancode set.

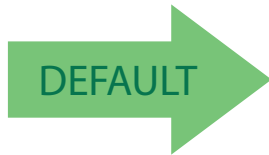

Keyboard Send Control Characters = Send Ctrl+Key



Keyboard Send Control Characters = Send Ctrl+Shift+Key



Keyboard Send Control Characters = Send Special Function Key :



## Intercharacter Delay

This parameter specifies the intercharacter delay between the end of one character and the beginning of the next. This parameter is only valid for USB Keyboard (without alternate key encoding) interface on the base station. The delay can be set within a range of zero (0) to 990 milliseconds in 10ms increments. A setting of zero specifies no delay. See "[Intercharacter Delay](#)" on page 233 for more detailed programming instructions.



Intercharacter Delay = No Delay



Select Intercharacter Delay Setting

To configure this feature, scan the ENTER/EXIT barcode above, then the barcode at left followed by digits from the Alphanumeric characters in [Appendix D, Keypad](#) representing your desired character(s). End by scanning the ENTER/EXIT barcode again.

Make a mistake? Scan the CANCEL barcode to abort and not save the entry string. You can then start again at the beginning.

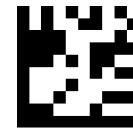

CANCEL

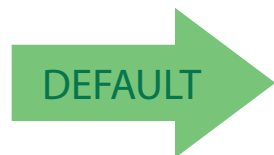

**00 = No Intercharacter Delay**



## Intercode Delay

Specifies the delay between labels transmitted to the host for this interface. The selectable range for this feature is from 0 to 99 seconds. See "Intercode Delay" on page 234 for more detailed programming instructions.



Set Intercode Delay

To configure this feature, scan the ENTER/EXIT barcode above, then the barcode at left followed by digits from the Alphanumeric characters in [Appendix D, Keypad](#) representing your desired character(s). End by scanning the ENTER/EXIT barcode again.

Make a mistake? Scan the CANCEL barcode to abort and not save the entry string. You can then start again at the beginning.



CANCEL

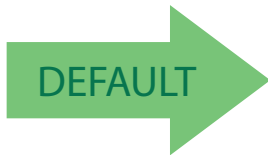

**00 = No Wedge Intercode Delay**



## USB Keyboard Speed

This option specifies the USB poll rate for a USB Keyboard.



**NOTE**

This feature applies **ONLY** to the Base station USB Keyboard interface.

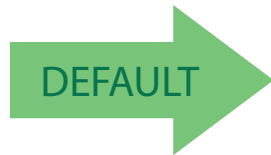

USB Keyboard Speed = 1ms



USB Keyboard Speed = 2ms



USB Keyboard Speed = 3ms



USB Keyboard Speed = 5ms



USB Keyboard Speed = 7ms



USB Keyboard Speed = 10ms



# NOTES



# USB-OEM Interface

<b>INTRODUCTION</b> on page 65
<b>STANDARD FACTORY SETTINGS</b> on page 65
<b>USB-OEM DEVICE USAGE</b> on page 66
<b>USB-OEM INTERFACE OPTIONS</b> on page 66

## Introduction

Feature settings for USB interfaces differ depending upon which host type the scanner will be connected with. Use the feature settings in this chapter to specifically configure for the USB-OEM interface. Other USB interfaces are included in the appropriate chapter for their host type.

## Standard Factory Settings

Reference [Appendix B](#), for a listing of standard factory settings.



## USB-OEM Device Usage

The USB-OEM protocol allows for the scanner to be identified as one of two different types of barcode scanners. Depending on what other scanners you may already have connected to a USB-OEM POS, you may need to change this setting to enable all devices to communicate.

Options are:

- Tabletop Scanner
- Handheld Scanner



**NOTE**

It may be necessary to switch device usage when connecting two scanners of the same type to a POS system.



USB-OEM Device Usage = Tabletop Scanner



USB-OEM Device Usage = Handheld Scanner



## USB-OEM Interface Options

This setting provides for an interface specific control mechanism.

Options are:

- Obey — Obey Scanner Configuration Host Commands
- Ignore — Ignore Scanner Configuration Host Commands



USB-OEM Interface Options = Obey



USB-OEM Interface Options = Ignore



# Data Format

<b>GLOBAL PREFIX/SUFFIX</b> on page 68
<b>GLOBAL AIM ID</b> on page 69
<b>GS1-128 AIM ID</b> on page 69
<b>LABEL ID</b> starting on page 70 <ul style="list-style-type: none"><li>•Label ID: Pre-loaded Sets on page 70</li><li>•Label ID: Set Individually Per Symbology on page 71</li><li>•Label ID Control on page 71</li><li>•Case Conversion on page 78</li></ul>
<b>CASE CONVERSION</b> on page 78
<b>CHARACTER CONVERSION</b> on page 78

The features in this chapter can be used to build specific user-defined data into a message string. See "References" starting on page 225 for more detailed instructions on setting these features.



## Global Prefix/Suffix

Up to 20 ASCII characters may be added as a prefix (in a position before the barcode data) and/or as a suffix (in a position following the barcode data). See "Global Prefix/Suffix" on page 236 for more detailed programming instructions.

To configure this feature, scan the ENTER/EXIT barcode above, then the barcode at left followed by digits from the Alphanumeric characters in [Appendix D, Keypad](#) representing your desired character(s). End by scanning the ENTER/EXIT barcode again.

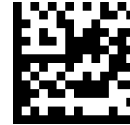

Set Global Prefix

To configure this feature, scan the ENTER/EXIT barcode above, then the barcode at left followed by digits from the Alphanumeric characters in [Appendix D, Keypad](#) representing your desired character(s). End by scanning the ENTER/EXIT barcode again.



Set Global Suffix

Make a mistake? Scan the CANCEL barcode to abort and not save the entry string. You can then start again at the beginning.

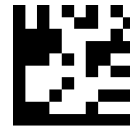

CANCEL

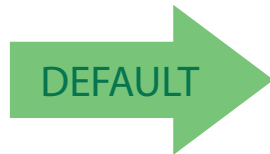

**No Global Prefix**  
**Global Suffix = 0x0D(CR)**

## Global AIM ID



This feature enables/disables addition of AIM IDs for all symbology types.

### NOTE

AIM label identifiers (as opposed to custom characters you select yourself as with label identifiers) can be included with scanned barcode data. See "Global AIM ID" on page 237 for more detailed programming instructions.

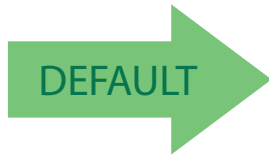

Global AIM ID = Disable



Global AIM ID = Enable

## GS1-128 AIM ID

If Global AIM ID is disabled, the AIM ID for GS1-128 can be enabled/disabled independently. The AIM ID for GS1-128 is a ]C1, ]C2 or ]C3. AIM IDs for other symbologies can be enabled/disabled independently as well. Contact Customer Support for assistance.



GS1-128 AIM ID = Disable



GS1-128 AIM ID = Enable





## Label ID

A Label ID is a customizable code of up to three ASCII characters (each can be one of hex 0x01–0xFF), used to identify a barcode (symbology) type. It can be appended previous to or following the transmitted barcode data depending upon how this option is enabled. This feature provides options for configuring custom Label IDs as a pre-loaded set (see "Label ID: Pre-loaded Sets" on page 70) or individually per symbology (see "Label ID: Set Individually Per Symbology" on page 71). If you wish to program the scanner to always include an industry standard label identifier for ALL symbology types, see the previous feature "Global AIM ID" on page 69.

### Label ID: Pre-loaded Sets

The scanner supports two pre-loaded sets of Label IDs, the USA set and the EU set. See "Label ID: Pre-loaded Sets" on page 238 for more information concerning the pre-loaded sets that are provided.



CAUTION

When changing from one Label ID set to another, all other scanner configuration settings, including the host interface type, will be erased and set to the factory defaults. Any custom configuration or custom defaults will be lost.



Label ID Pre-loaded Set = USA Set



Label ID Pre-loaded Set = EU Set

## Label ID: Set Individually Per Symbology

This feature configures a Label ID individually for a single symbology.



**NOTE**

This setting requires the scanning of barcodes from multiple sections. See "Label ID: Set Individually Per Symbology" on page 240 for more detailed programming instructions.

## Label ID Control

This option controls whether a Label ID is disabled, or sent as a prefix or suffix for a given symbology type.

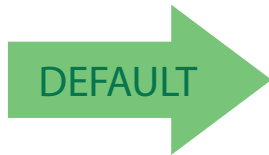

Label ID Transmission = Disable



Label ID Transmission = Enable as Prefix



Label ID Transmission = Enable as Suffix



CANCEL

Make a mistake? Scan the CANCEL barcode to abort and not save the entry string. You can then start again at the beginning.



## Individually Set Label ID

This feature configures a Label ID individually for a single symbology. To set, first define whether you want it as a prefix or suffix by scanning a label below. Then turn to [Label ID Symbology Selection – 1D Symbologies](#), starting on page 73 to select the symbology you want to set, followed by up to 3 characters from the ASCII Chart at the back of this manual. See "Label ID: Set Individually Per Symbology" on page 240 for detailed instructions on setting this feature.

### Label ID Control

This option controls whether a Label ID is disabled, or sent as a prefix or suffix for a given symbology type.

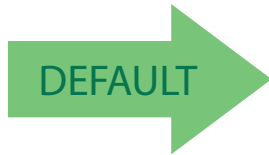

Label ID Transmission = Disable



Label ID Transmission = Enable as Prefix



Label ID Transmission = Enable as Suffix





### Label ID Symbology Selection – 1D Symbologies

This option selects the symbology for which a Label ID is to be configured. See "Label ID" on page 70 or page 240 in "References" for more detailed instructions.



If less than the expected string of 3 characters are selected, scan the ENTER/EXIT barcode twice to accept the selection and exit Programming Mode.



Set ABC Codabar Label ID Character(s)



Set Code 32 Pharmacode Label ID Character(s)



Set Anker Plessey Label ID Character(s)



Set Code 93 Label ID Character(s)



Set Australian Postal Code Label ID Character(s)



Set Concatenated ISBT 128 Label ID Character(s)



Set Codabar Label ID Character(s)



Set Danish PPT Label ID Character(s)



Set Code 11 Label ID Character(s)



Set EAN 13 Label ID Character(s)



Set Code 128 Label ID Character(s)



Set EAN 13 Composite Label ID Character(s)



Set Code 39 Label ID Character(s)



Set EAN 13 P2 Label ID Character(s)



**Case Conversion (continued)**



Set Code 39 CIP Label ID Character(s)



Set EAN 13 P5 Label ID Character(s)



Set EAN 8 Label ID Character(s)



Set GS1 DataBar Expanded Composite Label ID Character(s)



Set EAN 8 Composite Label ID Character(s)

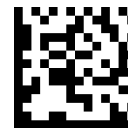

Set GS1-128 Label ID Character(s)



Set EAN 8 P2 Label ID Character(s)



Set GS1-128 Composite Label ID Character(s)



Set EAN 8 P5 Label ID Character(s)



Set GS1 DataBar Limited Label ID Character(s)



Set Follett 2 of 5 Label ID Character(s)



GS1 DataBar Limited Composite Label ID Character(s)



Set GS1 DataBar 14 Label ID Character(s)



Set GTIN 2 Label ID Character(s)



**Case Conversion (continued)**



Set GS1 DataBar 14 Composite Label ID Character(s)



Set GTIN 5 Label ID Character(s)



Set GS1 DataBar Expanded Label ID Character(s)



Set GTIN 8 Label ID Character(s)



Set IATA Industrial 2 of 5 Label ID Character(s)



Set LaPoste Code 39 Label ID Character(s)



Set IMB Postal Code Label ID Character(s)



Set MSI Label ID Character(s)



Set Industrial 2 of 5 Label ID Character(s)



Set Planet Postal Code Label ID Character(s)



Set Interleaved 2 of 5 Label ID Character(s)



Set Plessey Label ID Character(s)



Set ISBN Label ID Character(s)



Set Portugal Postal Code Label ID Character(s)



Set ISSN Label ID Character(s)



Set Postnet Label ID Character(s)



**Case Conversion (continued)**



Set Japan Postal Code Label ID Character(s)



Set Kix Postal Code Label ID Character(s)



Set PZN Code Label ID Character(s)



Set Postnet BB Label ID Character(s)



Set Royal Postal Code Label ID Character(s)



Set UPC-A Composite Label ID Character(s)



Set Standard 2 of 5 Label ID Character(s)

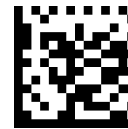

Set UPC-A P2 Label ID Character(s)



Set Swedish Postal Code Label ID Character(s)



Set UPC-A P5 Label ID Character(s)



Set Trioptic Code Label ID Character(s)



Set UPC-E Label ID Character(s)

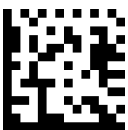

Set UPC-A Label ID Character(s)



Set UPC-E P5 Label ID Character(s)



## Label ID Symbology Selection – 2D Symbologies



Set Aztec Label ID Character(s)



Set Maxicode Label ID Character(s)



Set China Sensible Label ID Character(s)



Set PDF 417 Label ID Character(s)



Set Data Matrix Label ID Character(s)



Set Micro PDF 417 Label ID Character(s)



Set Micro QR Label ID Character(s)



Set QR Code Label ID Character(s)



# Case Conversion

This feature allows conversion of the case of all alphabetic characters to upper or lower case.



**NOTE**

Case conversion affects **ONLY** scanned barcode data, and does not affect Label ID, Prefix, Suffix, or other appended data.

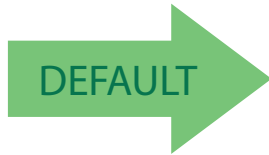

Case Conversion = Disable (no case conversion)



Case Conversion = Convert to upper case



Case Conversion = Convert to lower case

# Character Conversion

Character conversion is an eight byte configuration item. The eight bytes are 4 character pairs represented in hexadecimal ASCII values. The first character in the pair is the character that will be converted. The second character in the pair is the character to convert to. If the character to convert in a pair is FF, then no conversion is done. See "[Character Conversion](#)" on page 242 for more detailed programming instructions.



Configure Character Conversion

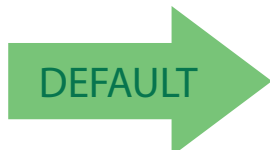

**0xFFFFFFFFFFFFFFF**  
(No character conversion)

## Reading Parameters

<b>DOUBLE READ TIMEOUT</b> on page 80	<b>GOOD READ SPEAKER VOLUME</b> on page 91
<b>LED AND SPEAKER INDICATORS</b> on page 82	<b>GOOD READ BEEP LENGTH</b> on page 92
<b>POWER ON ALERT</b> on page 82	<b>ENABLE/DISABLE GOOD READ INDICATOR</b> on page 95
<b>AUDIO JINGLE ENABLE</b> on page 83	<b>GOOD READ LED COLOR</b> on page 95
<b>SELECT AUDIO JINGLE FOR POWER-UP EVENT</b> on page 84	<b>SCANNER IDLE LED COLOR</b> on page 97
<b>SELECT AUDIO JINGLE FOR GOOD READ EVENT</b> on page 85	<b>RGB GOOD READ FALLING TIME</b> on page 99
<b>SELECT AUDIO JINGLE FOR ENTER BASE STATION</b> on page 86	<b>RGB GOOD READ HOLDING TIME</b> on page 100
<b>SELECT AUDIO JINGLE FOR EXIT BASE STATION</b> on page 87	<b>RGB AUTO DELAY</b> on page 101
<b>SELECT AUDIO JINGLE FOR TRANSMIT ERROR SOUND</b> on page 88	<b>SCAN MODE</b> on page 103
<b>GOOD READ: WHEN TO INDICATE</b> on page 89	<b>SCANNING ACTIVE TIME</b> on page 104
<b>GOOD READ BEEP TYPE</b> on page 90	<b>PICK MODE</b> on page 104
<b>GOOD READ BEEP FREQUENCY</b> on page 90	



## Double Read Timeout

To prevent a double read of the same label, the Double Read Timeout sets the minimum time allowed between reads of labels of the same symbology and data. If the unit reads a label and sees the same label again within the Double Read Timeout, the second read of the label will be ignored. Double Read Timeout does not apply to scan modes that require a trigger pull for each label that is read.



Double Read Timeout = 0.1 Second



Double Read Timeout = 0.2 Second



Double Read Timeout = 0.3 Second

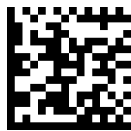

Double Read Timeout = 0.4 Second





## Double Read Timeout (continued)



Double Read Timeout = 0.5 Second



Double Read Timeout = 0.6 Second



Double Read Timeout = 0.7 Second



Double Read Timeout = 0.8 Second



Double Read Timeout = 0.9 Second



Double Read Timeout = 1 Second



## LED and Speaker Indicators

### Power On Alert

Disables or enables the indication (from the Speaker) that the scanner is receiving power.



Power On Alert = Disable (No Audible Indication)



Power On Alert = Power-up Beep



### Audio Jingles

The scanner can be set up to sound a predefined “jingle” or traditional beep sounds to indicate good read and power-up events.

To upload a jingle, contact the Customer Support.



## Audio Jingle Enable

This option determines whether the scanner will sound predefined “Jingles” (a short, user-defined tune uploaded via Datalogic Aladdin™ configuration software) or traditional beep sounds to indicate good read.

See below for parameters to define which preloaded Jingle to sound upon power-up or good read events. Additional items such as enter stand mode, exit stand mode, and error beep can also be programmed using Datalogic Aladdin.

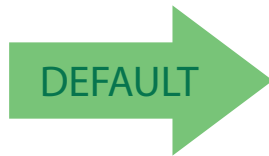

Audio Jingle = Disable (Use traditional beep sounds)



Audio Jingle = Enable Jingles



## Select Audio Jingle for Power-up Event

Selects which preloaded Jingle to use to indicate scanner power-up.



**NOTE**

Audio Jingles must be enabled (using the previous option) for this selection to take effect.

After uploading up to fifteen (15) Jingles to the scanner using the Datalogic Aladdin™ configuration utility, use this setting to specify which of the Jingles (1-15) or the built-in sound will be used to indicate scanner power-up. The built-in (default) sound for power-up is Dialtone.wav.



Select Audio Jingle on Power-up

To configure this feature, scan the ENTER/EXIT barcode above, then the barcode at left followed by two digits from the Alphanumeric characters in [Appendix D, Keypad](#) representing the desired Jingle #. End by scanning the ENTER/EXIT barcode again.

Make a mistake? Scan the CANCEL barcode to abort and not save the entry string. You can then start again at the beginning.

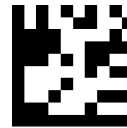

CANCEL

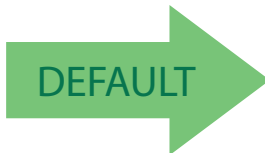

**00 = Use built-in power-up sound**



**NOTE**

The capability to download Audio jingle require Datalogic Aladdin™ configuration software, for this reason it is possible only if the reader is used with the base station.

## Select Audio Jingle for Good Read Event

This parameter selects which preloaded Jingle to use in indicating a good read event.



"Audio Jingle Enable" on page 83 must be selected for this configuration item to take effect.

**NOTE**

After uploading up to fifteen (15) Jingles to the scanner using the Datalogic Aladdin™ configuration utility, use this setting to designate which of the Jingles (1–15) will be sounded when the scanner performs a good read.



Select Audio Jingle on Good Read

To configure this feature, scan the ENTER/EXIT barcode above, then the barcode at left followed by two digits from the Alphanumeric characters in [Appendix D, Keypad](#) representing the desired Jingle #. End by scanning the ENTER/EXIT barcode again.

Make a mistake? Scan the CANCEL barcode to abort and not save the entry string. You can then start again at the beginning.



CANCEL

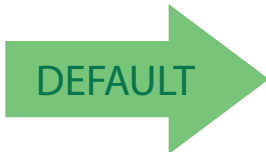

**00 = Use built-in Good Read Jingle (Shutter.wav)**



**NOTE**

The capability to download Audio jingle require Datalogic Aladdin™ configuration software, for this reason it is possible only if the reader is used with the base station.



## Select Audio Jingle for Enter Base Station

This parameter selects which preloaded Jingle to use in indicating an Enter Base Station event.



"Audio Jingle Enable" on page 83 must be selected for this configuration item to take effect.

**NOTE**

After uploading up to fifteen (15) Jingles to the scanner using the Datalogic Aladdin™ configuration utility, use this setting to designate which of the Jingles (1–15) will be sounded when the scanner enters Base Station.



Select Audio Jingle on Enter Stand Mode

To configure this feature, scan the ENTER/EXIT barcode above, then the barcode at left followed by two digits from the Alphanumeric characters in [Appendix D, Keypad](#) representing the desired Jingle #. End by scanning the ENTER/EXIT barcode again.

Make a mistake? Scan the CANCEL barcode to abort and not save the entry string. You can then start again at the beginning.



CANCEL

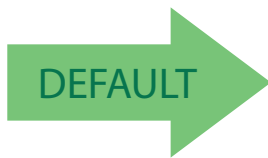

**00 = Use built-in Enter Base Station indication**



The capability to download Audio jingle require Datalogic Aladdin™ configuration software, for this reason it is possible only if the reader is used with the base station.

**NOTE**



## Select Audio Jingle for Exit Base Station

This parameter selects which preloaded Jingle to use in indicating an Exit Base Station event.



**NOTE**

"Audio Jingle Enable" on page 83 must be selected for this configuration item to take effect.

After uploading up to fifteen (15) Jingles to the scanner using the Datalogic Aladdin™ configuration utility, use this setting to designate which of the Jingles (1-15) will be sounded when the scanner exits Base Station.



Select Audio Jingle on Exit Stand Mode

To configure this feature, scan the ENTER/EXIT barcode above, then the barcode at left followed by two digits from the Alphanumeric characters in [Appendix D, Keypad](#) representing the desired Jingle #. End by scanning the ENTER/EXIT barcode again.

Make a mistake? Scan the CANCEL barcode to abort and not save the entry string. You can then start again at the beginning.



CANCEL

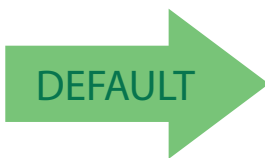

**00 = Use built-in Exit Base Station indication**



**NOTE**

The capability to download Audio jingle require Datalogic Aladdin™ configuration software, for this reason it is possible only if the reader is used with the base station.



## Select Audio Jingle for Transmit Error Sound

This parameter selects which preloaded Jingle to use to indicate a Transmit Error sound.



"Audio Jingle Enable" on page 83 must be selected for this configuration item to take effect.

**NOTE**

After uploading up to fifteen (15) Jingles to the scanner using the Datalogic Aladdin™ configuration utility, use this setting to designate which of the Jingles (1-15) will be sounded when the scanner performs a good read.



Select Audio Jingle on Tx Error event

To configure this feature, scan the ENTER/EXIT barcode above, then the barcode at left followed by two digits from the Alphanumeric characters in [Appendix D, Keypad](#) representing the desired Jingle #. End by scanning the ENTER/EXIT barcode again.

Make a mistake? Scan the CANCEL barcode to abort and not save the entry string. You can then start again at the beginning.



CANCEL

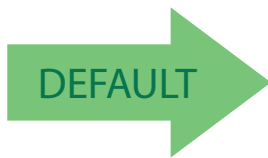

**00 = Use built-in Transmit Error Sound indication**



The capability to download Audio jingle require Datalogic Aladdin™ configuration software, for this reason it is possible only if the reader is used with the base station.

**NOTE**





## Good Read: When to Indicate

This feature specifies when the scanner will provide indication (beep or Jingle and/or LED) upon successfully reading a barcode. Choices are:

- Good Read = Indicate after decode
- Good Read = Indicate after transmit
- Good Read = Indicate after CTS goes inactive, then active



### NOTE

This option, which uses CTS, is only valid for RS-232 interfaces.



Indicate Good Read = After Decode



Indicate Good Read = After Transmit



Indicate Good Read = After CTS Goes Inactive, Then Active



## Good Read Beep Type

Specifies whether the good read beep has a mono or bitonal beep sound.

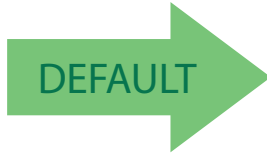

Good Read Beep Type = Mono



Good Read Beep Type = Bitonal

## Good Read Beep Frequency

Adjusts the good read beep to sound at a selectable low, medium or high frequency, selectable from the list below. (Controls the speaker's pitch/tone.)



Good Read Beep Frequency = Low



Good Read Beep Frequency = Medium

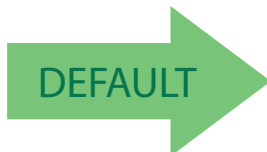

Good Read Beep Frequency = High



## Good Read Speaker Volume

Selects the speaker volume (loudness) upon a good read jingle or beep. There are three selectable volume levels.



Good Read Speaker Volume = Speaker Off



Good Read Speaker Volume = Low



Good Read Speaker Volume = Medium



Good Read Speaker Volume = High



**WARNING**

Depending on the setting of this configuration parameter, the operating time between the charges is reduced.



## Good Read Beep Length

Specifies the duration of a good read beep.



Good Read Beep Length = 60 msec



Good Read Beep Length = 80 msec



Good Read Beep Length = 100 msec



Good Read Beep Length = 120 msec



Good Read Beep Length = 140 msec



Good Read Beep Length = 160 msec



## Good Read Beep Length (continued)



Good Read Beep Length = 180 msec



Good Read Beep Length = 200 msec



**WARNING**

Depending on the setting of this configuration parameter, the operating time between the charges is reduced.



## RGB LED Settings

The following configuration items specify settings for the RGB (Red Green Blue) LEDs, which are used to indicate Good Read and Body Illumination when Scanner is in Idle mode.

To set the RGB LEDs to a desired color and brightness:

1. Install Datalogic Aladdin™ (v 1.12.0.0 or later) on your computer.
2. Connect the scanner you want to program to the computer.
3. Select **Device Autodetection** > **Search on Connection** and follow instructions to set up communication with the scanner.
4. After the Configuration screen opens, click on **RGB Led Settings** in the **Reading Parameters** folder (**Expert Mode**) to open RGB dialog.

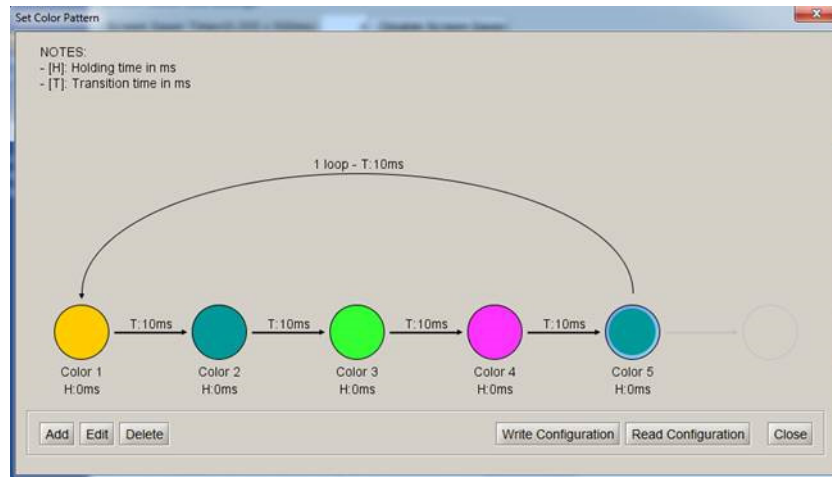
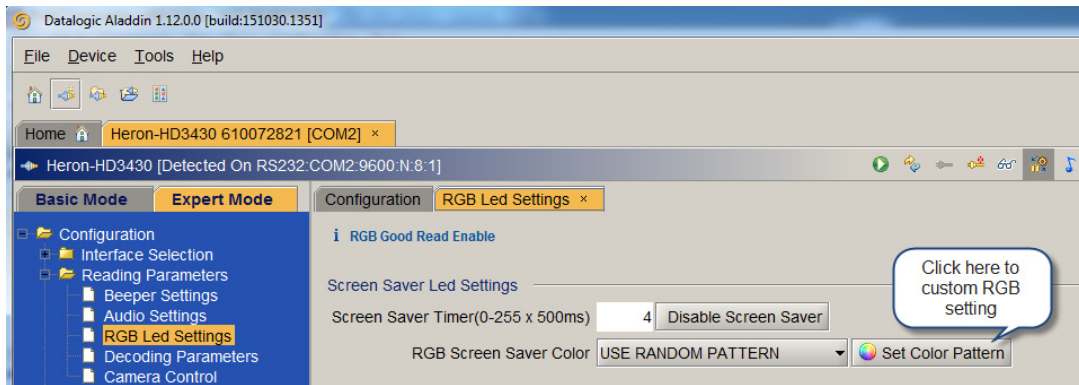

**WARNING**

Depending on the setting of RGB LED configuration parameters, the operating time between the charges is reduced.



## Enable/Disable Good Read Indicator

Enable/Disable the good read indicator.



## Good Read LED Color

Specifies the color of the RGB Good Read LED.





## Enable/Disable Body Illumination

Enable/Disable the Body Illumination when Scanner is in Idle mode.



Body Illumination = Disable



Good Read Indicator = Enable







## Scanner Idle LED Color

Specifies the color of the Idle LED.

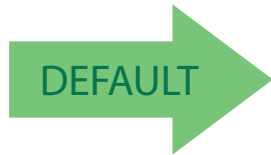

Color = Solid Blue



Color = Solid Yellow



Color = Solid Red



Color = Solid Purple



Color = Solid Green\*



Color = Random Colors

\* In this case a different Color should be chosen for the Good Read LED.



**NOTE**

To define complex patterns, please use Aladdin to set up.



## RGB Good Read Raising Time

Specifies the time it will take for the RGB good read to change the status from an Off state to Brightness state.

See "RGB Good Read Raising/Falling Time" on page 243 for more detailed programming instructions.



Set RGB Good Read Raising Time

To configure this feature, scan the ENTER/EXIT barcode above, then the barcode at left followed by two digits from the Alphanumeric characters in [Appendix D, Keypad](#) representing your desired character(s). End by scanning the ENTER/EXIT barcode again.

Make a mistake? Scan the CANCEL barcode to abort and not save the entry string. You can then start again at the beginning.

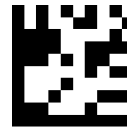

CANCEL

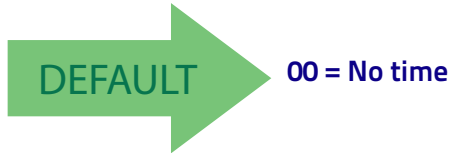



## RGB Good Read Falling Time

Specifies the time for the RGB good read to change the status from the Brightness state to the Off state.

See "RGB Good Read Raising/Falling Time" on page 243 for more detailed programming instructions.

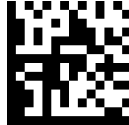

Set RGB Good Read Falling Time

To configure this feature, scan the ENTER/EXIT barcode above, then the barcode at left followed by digits from the Alphanumeric characters in [Appendix D, Keypad](#) representing your desired character(s). End by scanning the ENTER/EXIT barcode again.

Make a mistake? Scan the CANCEL barcode to abort and not save the entry string. You can then start again at the beginning.

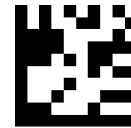

CANCEL

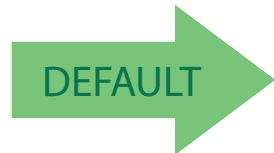

**14 = 2 seconds Falling Time**



## RGB Good Read Holding Time

Specifies how long the RGB good read will stay in Brightness state. See "RGB Good Read Holding Time" on page 244 for more information.



Set RGB Good Read Holding Time

To configure this feature, scan the ENTER/EXIT barcode above, then the barcode at left followed by digits from the Alphanumeric characters in [Appendix D, Keypad](#) representing your desired character(s). End by scanning the ENTER/EXIT barcode again.

Make a mistake? Scan the CANCEL barcode to abort and not save the entry string. You can then start again at the beginning.

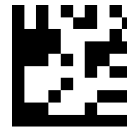

CANCEL

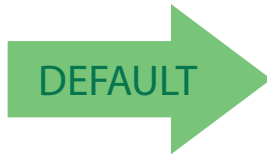

**14 = 2 seconds Holding Time**



## RGB Auto Delay

Specifies the delay time for running the RGB auto mode after the scanner has gone into an idle state (no label reading, label programming or communication with Host). The value 0x00 means Auto Mode is disabled. See "[RGB Auto Delay Time](#)" on page 245 for more information.



Set RGB Auto Delay

To configure this feature, scan the ENTER/EXIT barcode above, then the barcode at left followed by digits from the Alphanumeric characters in [Appendix D, Keypad](#) representing your desired character(s). End by scanning the ENTER/EXIT barcode again.

Make a mistake? Scan the CANCEL barcode to abort and not save the entry string. You can then start again at the beginning.

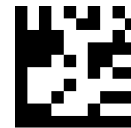

CANCEL

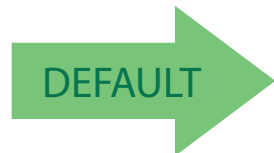

**04 = 2 seconds Auto Delay**



## Viber

The scanner includes a motor that, when configured to be enabled, can vibrate after a successful decode.



**WARNING**

Depending on the setting of this configuration parameter, the operating time between the charges is reduced.



## Scanning Features

### Scan Mode

See "Scan Mode" on page 246 for more detailed programming instructions.



Scan Mode = Trigger Single



DEFAULT



Scan Mode = Trigger Hold Multiple



Scan Mode = Trigger Pulse Multiple



### Scanning Active Time

This setting specifies the amount of time that the reader stays in scan ON state once the state is entered. The range for this setting is from 1 to 255 seconds in 1-second increments. See "Scanning Active Time" on page 246 for more detailed programming instructions.



Select Scanning Active Time Setting

To configure this feature, scan the ENTER/EXIT barcode above, then the barcode at left followed by digits from the Alphanumeric characters in [Appendix D, Keypad](#) representing your desired character(s). End by scanning the ENTER/EXIT barcode again.

Make a mistake? Scan the CANCEL barcode to abort and not save the entry string. You can then start again at the beginning.

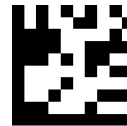

CANCEL

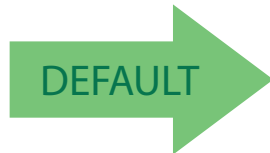

005 = Scanning is active for 5 Seconds

### Pick Mode

Specifies the ability of the reader to decode labels only when they are close to the center of the aiming pattern. This allows the reader to accurately target labels when they are placed close together, such as on a pick sheet.



NOTE

This feature is not compatible with Multiple Labels Reading in a Volume.

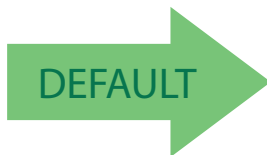

Pick Mode = Disable



Pick Mode = Enable



# 1D Symbologies

## Introduction

The scanner supports the following 1D symbologies (barcode types). Symbology-dependent options for each symbology are included in this chapter. See "2D Symbologies" starting on page 193 for configuration of 2D barcodes.

UPC-A on page 107	Interleaved 2 of 5 (I 2 of 5) on page 142
UPC-E on page 109	Interleaved 2 of 5 CIP HR on page 148
EAN 13 on page 112	Datalogic 2 of 5 on page 149
EAN 13 on page 112 (JAN 13)	Codabar on page 153
EAN 8 on page 115 (JAN 8)	ABC Codabar on page 160
Add-Ons on page 118	Code 11 on page 162
GS1 DataBar™ Omnidirectional on page 120	Standard 2 of 5 on page 166
GS1 DataBar™ Expanded on page 121	Industrial 2 of 5 on page 170
GS1 DataBar™ Limited on page 124	IATA on page 174
Code 39 on page 125	ISBT 128 on page 175
Code 32 (Italian Pharmaceutical) on page 133	MSI on page 178
Code 39 CIP (French Pharmaceutical) on page 134	Code 93 on page 182
Code 128 on page 135	Follett 2 of 5 on page 188
GS1-128 on page 141	BC412 on page 188

## Standard Factory Settings for Symbologies

Default settings are indicated at each feature/option with a green arrow. Also reference [Appendix B](#), for a listing of the most widely used set of standard factory settings. That section also provides space to record any custom settings needed or implemented for your system.



## Disable All Symbologies

Scan this label to disable all symbologies.



Disable all symbologies

## Coupon Control

This feature is used to control the method of processing coupon labels.

Options are:

- Allow all — allow all coupon barcodes to be decoded
- Enable only UPC/EAN — enables only UPC/EAN coupon decoding
- Enable only GS1 DataBar — enables only GS1 DataBar coupon decoding

To set this feature:

1. Scan the Enter/Exit barcode.
2. Scan either the enable or disable barcode below. You'll need to cover any unused barcodes on this and the facing page to ensure that the scanner sees only the barcode you intend to scan.
3. Complete the programming sequence by scanning the Enter/Exit barcode.



Coupon Control = Allow all



Coupon Control = Enable only UPC/EAN



Coupon Control = Enable only GS1 DataBar

## UPC-A

The following options apply to the UPC-A symbology.

### UPC-A Enable/Disable

When disabled, the scanner will not read UPC-A barcodes.



### UPC-A Check Character Transmission

Enable this option to transmit the check character along with UPC-A barcode data.





## Expand UPC-A to EAN-13

Expands UPC-A data to the EAN-13 data format. Selecting this feature also changes the symbology ID to match those required for EAN-13.

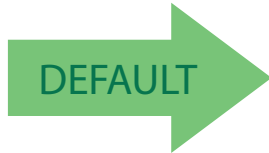

UPC-A to EAN-13 = Don't Expand



UPC-A to EAN-13 = Expand

## UPC-A Number System Character Transmission

This feature enables/disables transmission of the UPC-A number system character.



UPC-A Number System Character = Do not transmit



UPC-A Number System Character = Transmit



## UPC-E

The following options apply to the UPC-E symbology.

### UPC-E Enable/Disable

When disabled, the scanner will not read UPC-E barcodes.



### UPC-E Check Character Transmission

Enable this option to transmit the check character along with UPC-E barcode data.





## Expand UPC-E to EAN-13

Expands UPC-E data to the EAN-13 data format. Selecting this feature also changes the symbology ID to match those required for EAN-13.

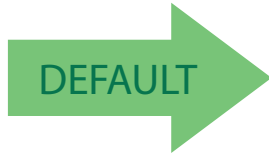

UPC-E to EAN-13 = Don't Expand

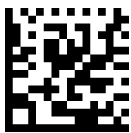

UPC-E to EAN-13 = Expand

## Expand UPC-E to UPC-A

Expands UPC-E data to the UPC-A data format.

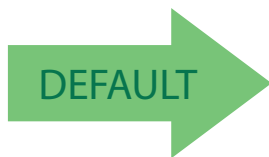

UPC-E to UPC-A = Don't Expand



UPC-E to UPC-A = Expand



## UPC-E Number System Character Transmission

This feature enables/disables transmission of the UPC-E system number character.



UPC-E Number System Character = Do not transmit



UPC-E Number System Character = Transmit



## EAN 13

The following options apply to the EAN 13 (Jan 13) symbology.

### EAN 13 Enable/Disable

When disabled, the scanner will not read EAN 13/JAN 13 barcodes.



### EAN 13 Check Character Transmission

Enable this option to transmit the check character along with EAN 13 barcode data.

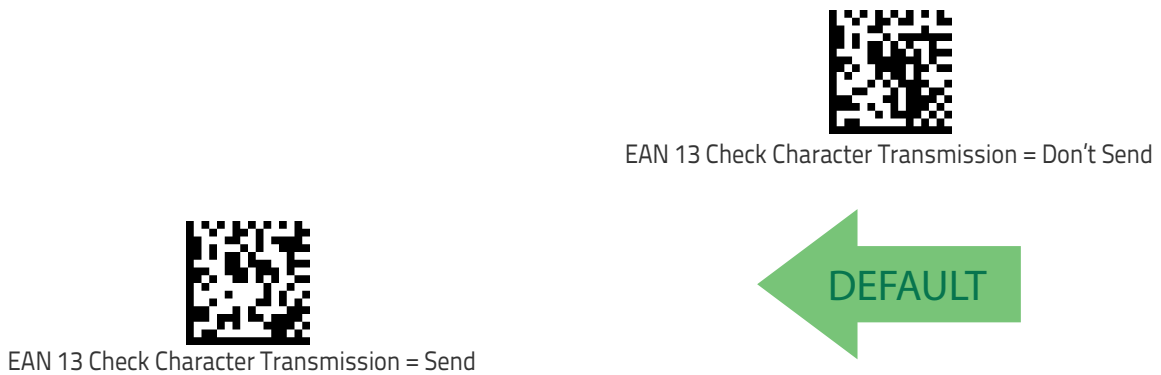



## EAN-13 Flag 1 Character

Enables/disables transmission of an EAN/JAN13 Flag1 character. The Flag 1 character is the first character of the label.

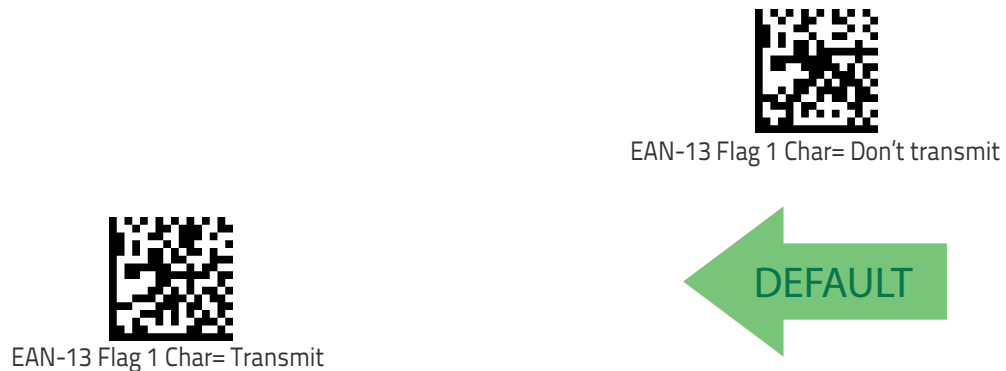

## EAN-13 ISBN Conversion

This option enables/disables conversion of EAN 13/JAN 13 Bookland labels starting with 978 to ISBN labels.





## ISSN Enable/Disable

Enables/disables conversion of EAN/JAN13 Bookland labels starting with 977 to ISSN labels.

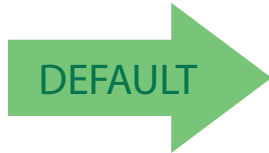

ISSN = Disable



ISSN = Enable

## EAN 8

The following options apply to the EAN 8 (Jan 8) symbology.

### EAN 8 Enable/Disable

When disabled, the scanner will not read EAN 8/JAN 8 barcodes.



### EAN 8 Check Character Transmission

Enable this option to transmit the check character along with EAN 8 barcode data.





## Expand EAN 8 to EAN 13

Enable this option to expand EAN 8/JAN 8 labels to EAN 13/JAN 13.

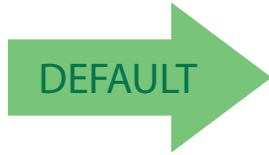

Expand EAN 8 to EAN 13 = Disable



Expand EAN 8 to EAN 13 = Enable

## UPC/EAN Global Settings

This section provides configuration settings for UPC-A, UPC-E, EAN 13 and EAN 8 symbologies, and affects all of these unless otherwise marked for each feature description.

### UPC/EAN Price Weight Check

This feature enables/disables calculation and verification of price/weight check digits.

Options are

- Disabled
- Enable 4-digit price-weight check-digit calculation
- Enable 5-digit price-weight check-digit calculation
- Enable European 4-digit price-weight check-digit calculation
- Enable European 5-digit price-weight check-digit calculation

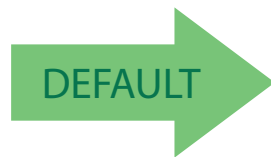

Price Weight Check = Disabled



Price Weight Check = 4-digit price-weight check



Price Weight Check = 5-digit price-weight check



Price Weight Check = European 4-digit price-weight check



Price Weight Check = European 5-digit price-weight check



# Add-Ons

The following features apply to optional add-ons.



**NOTE**

Contact Customer Support for advanced programming of optional and conditional add-ons.

## Optional Add-ons

The scanner can be enabled to optionally read the following add-ons (supplementals):

- P2
- P5



**NOTE**

If a UPC/EAN base label and a an add-on are both decoded, the scanner will transmit the base label and add-on. If a UPC/EAN base label is decoded without an add-on, the base label will be transmitted without an add-on.

Conditional add-on settings (if enabled) are considered by the scanner before optional add-on settings.

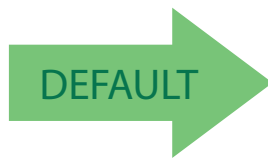

Optional Add-Ons = Disable P2



Optional Add-Ons = Enable P2

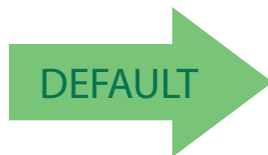

Optional Add-Ons = Disable P5



Optional Add-Ons = Enable P5

## Optional Add-On Timer

This option sets the time the scanner will look for an add-on when an add-on fragment has been seen and optional add-ons are enabled.



Optional Add-on Timer = 10ms



Optional Add-on Timer = 20ms



Optional Add-on Timer = 30ms



Optional Add-on Timer = 50ms



Optional Add-on Timer = 70ms



Optional Add-on Timer = 100ms



Optional Add-on Timer = 160ms



## GS1 DataBar™ Omnidirectional

The following options apply to the GS1 DataBar Omnidirectional (formerly RSS-14) symbology.

### GS1 DataBar Omnidirectional Enable/Disable

When disabled, the scanner will not read GS1 DataBar Omnidirectional barcodes.

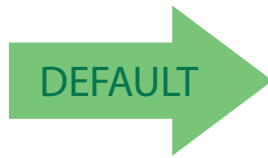

GS1 DataBar Omnidirectional = Disable



GS1 DataBar Omnidirectional = Enable

### GS1 DataBar Omnidirectional GS1-128 Emulation

When enabled, GS1 DataBar Omnidirectional barcodes will be translated to the GS1-128 label data format.

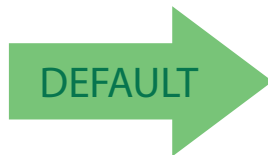

GS1 DataBar Omnidirectional GS1-128 Emulation = Disable



GS1 DataBar Omnidirectional GS1-128 Emulation = Enable



## GS1 DataBar™ Expanded

The following options apply to the GS1 DataBar Expanded (formerly RSS Expanded) symbology.

### GS1 DataBar Expanded Enable/Disable

When disabled, the scanner will not read GS1 DataBar Expanded barcodes.

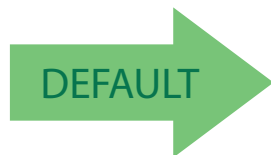

GS1 DataBar Expanded = Disable



GS1 DataBar Expanded = Enable

### GS1 DataBar Expanded GS1-128 Emulation

When enabled, GS1 DataBar Expanded barcodes will be translated to the GS1-128 label data format.

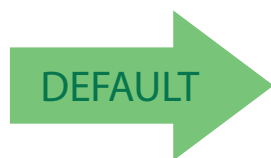

GS1 DataBar Expanded GS1-128 Emulation = Disable



GS1 DataBar Expanded GS1-128 Emulation = Enable



### GS1 DataBar Expanded Length Control

This feature specifies either variable length decoding or fixed length decoding for the GS1 DataBar Expanded symbology.

**Variable Length:** For variable-length decoding, a minimum length may be set.

**Fixed Length:** For fixed-length decoding, two different lengths may be set.

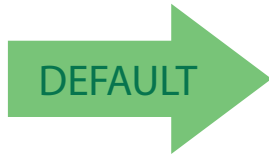

GS1 DataBar Expanded Length Control = Variable Length



GS1 DataBar Expanded Length Control = Fixed Length

### GS1 DataBar Expanded Set Length 1

This feature specifies one of the barcode lengths for GS1 DataBar Expanded Length Control on page 122. Length 1 is the minimum label length if in Variable Length on page 122 Mode, or the first fixed length if in Fixed Length on page 122 Mode. Length includes the barcode's data characters only.

The length can be set from 1 to 74 characters. See "Set Length 1" on page 248 for more detailed programming instructions.



Select GS1 DataBar Expanded Set Length 1 Setting

To configure this feature, scan the ENTER/EXIT barcode above, then the barcode at left followed by digits from the Alphanumeric characters in [Appendix D, Keypad](#) representing your desired character(s). End by scanning the ENTER/EXIT barcode again.

Make a mistake? Scan the CANCEL barcode to abort and not save the entry string. You can then start again at the beginning.

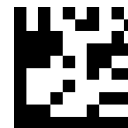

CANCEL

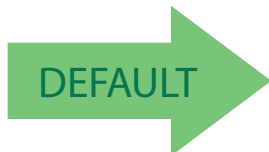

01 = Length 1 is 1 Character

## GS1 DataBar Expanded Set Length 2

This feature specifies one of the barcode lengths for [GS1 DataBar Expanded Length Control on page 122](#). Length 2 is the maximum label length if in [Variable Length on page 122 Mode](#), or the second fixed length if in [Fixed Length on page 122 Mode](#). Length includes the barcode's data characters only.

The length can be set from 1 to 74 characters. A setting of 00 specifies to ignore this length (only one fixed length). See ["Set Length 2" on page 249](#) for more detailed programming instructions.

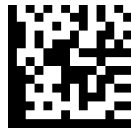

Select GS1 DataBar Expanded Set Length 2 Setting

To configure this feature, scan the ENTER/EXIT barcode above, then the barcode at left followed by digits from the Alphanumeric characters in [Appendix D, Keypad](#) representing your desired character(s). End by scanning the ENTER/EXIT barcode again.

Make a mistake? Scan the CANCEL barcode to abort and not save the entry string. You can then start again at the beginning.

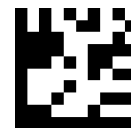

CANCEL

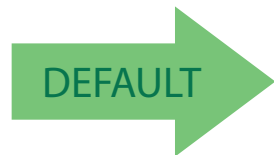

**74 = Length 2 is 74 Characters**



## GS1 DataBar™ Limited

The following options apply to the GS1 DataBar Limited (formerly RSS Limited) symbology.

### GS1 DataBar Limited Enable/Disable

When disabled, the scanner will not read GS1 DataBar Limited barcodes.

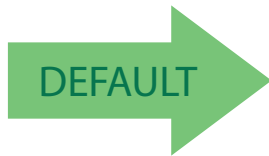

GS1 DataBar Limited = Disable



GS1 DataBar Limited = Enable

### GS1 DataBar Limited GS1-128 Emulation

When enabled, GS1 DataBar Limited barcodes will be translated to the GS1-128 label data format.

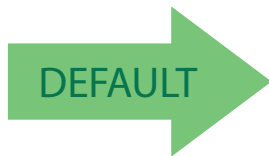

GS1 DataBar Limited GS1-128 Emulation = Disable



GS1 DataBar Limited GS1-128 Emulation = Enable



## Code 39

The following options apply to the Code 39 symbology.

### Code 39 Enable/Disable

When disabled, the scanner will not read Code 39 barcodes.





## Code 39 Check Character Calculation

Enable this option to enable/disable calculation and verification of an optional Code 39 check character. When disabled, any check character in the label is treated as a data character.

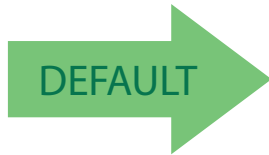

Code 39 Check Character Calculation = Don't Calculate



Code 39 Check Character Calculation = Calculate Std Check



Code 39 Check Character Calculation = Calculate Mod 7 Check



Code 39 Check Character Calculation = Enable Italian Post Check



Code 39 Check Character Calculation = Enable Daimler Chrysler Check

## Code 39 Check Character Transmission

Enable this option to transmit the check character along with Code 39 barcode data.

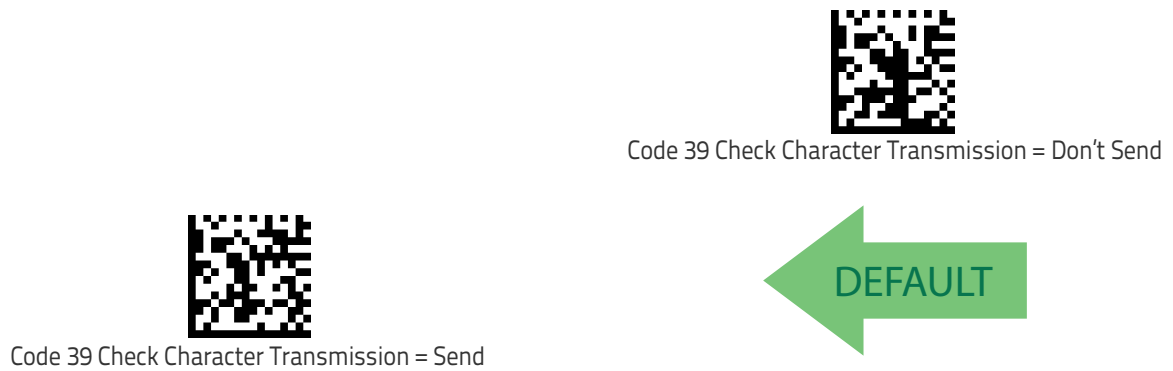

## Code 39 Start/Stop Character Transmission

Enable this option to enable/disable transmission of Code 39 start and stop characters.

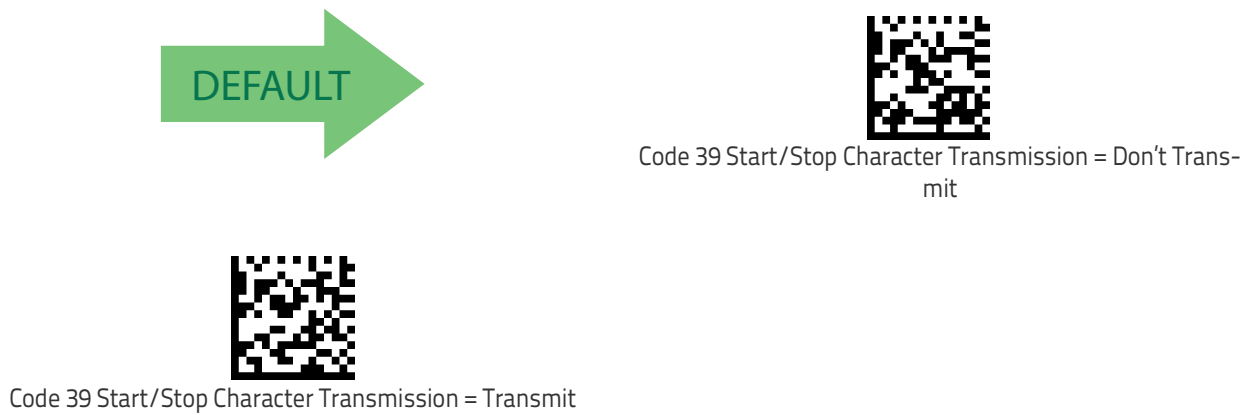



## Code 39 Full ASCII

In Code 39 decoding, this enables/disables the translation of Code 39 characters to Code 39 full-ASCII characters.

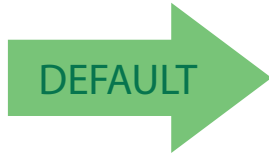

Code 39 Full ASCII = Disable



Code 39 Full ASCII = Enable



## Code 39 Quiet Zones

This feature specifies the number of quiet zones for Code 39 labels. Quiet zones are blank areas at the ends of a barcode and are typically 10 times the width of the narrowest bar or space in the label.



Code 39 Quiet Zones = Quiet Zone on one side



Code 39 Quiet Zones = Quiet Zones on two sides



Code 39 Quiet Zones = Auto



Code 39 Quiet Zones = Virtual Quiet Zones on two sides



Code 39 Quiet Zones = Small Quiet Zones on two sides



## Code 39 Length Control

This feature specifies either variable length decoding or fixed length decoding for the Code 39 symbology.

**Variable Length:** For variable length decoding, a minimum and maximum length may be set.

**Fixed Length:** For fixed length decoding, two different lengths may be set.

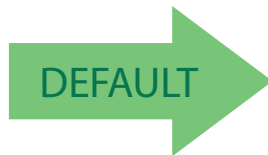

Code 39 Length Control = Variable Length



Code 39 Length Control = Fixed Length



## Code 39 Set Length 1

This feature specifies one of the barcode lengths for [Code 39 Length Control on page 130](#). Length 1 is the minimum label length if in [Variable Length on page 130 Mode](#), or the first fixed length if in [Fixed Length on page 130 Mode](#). Length includes the barcode's check, data, and full-ASCII shift characters. The length does not include start/stop characters.

The length can be set from 0 to 50 characters. See "[Set Length 1](#)" on page 248 for more detailed programming instructions.

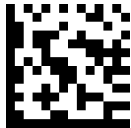

Select Code 39 Set Length 1 Setting

To configure this feature, scan the ENTER/EXIT barcode above, then the barcode at left followed by digits from the Alphanumeric characters in [Appendix D, Keypad](#) representing your desired character(s). End by scanning the ENTER/EXIT barcode again.

Make a mistake? Scan the CANCEL barcode to abort and not save the entry string. You can then start again at the beginning.

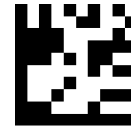

CANCEL

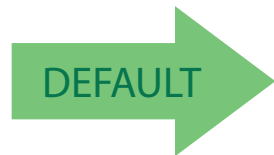

**02 = Length 1 is 2 Characters**



## Code 39 Set Length 2

This feature specifies one of the barcode lengths for [Code 39 Length Control on page 130](#). Length 2 is the maximum label length if in [Variable Length on page 130 Mode](#), or the second fixed length if in [Fixed Length on page 130 Mode](#). Length includes the barcode's check, data, and full-ASCII shift characters. The length does not include start/stop characters.

The length can be set from 1 to 50 characters. A setting of 00 specifies to ignore this length (only one fixed length). See ["Set Length 2" on page 249](#) for more detailed programming instructions.



Select Code 39 Length 2 Setting

To configure this feature, scan the ENTER/EXIT barcode above, then the barcode at left followed by digits from the Alphanumeric characters in [Appendix D, Keypad](#) representing your desired character(s). End by scanning the ENTER/EXIT barcode again.

Make a mistake? Scan the CANCEL barcode to abort and not save the entry string. You can then start again at the beginning.



CANCEL

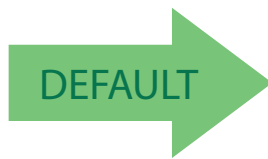

**50 = Length 2 is 50 Characters**

## Code 32 (Italian Pharmaceutical)

The following options apply to the Code 32 symbology.

### Code 32 Enable/Disable

When disabled, the scanner will not read Code 32 barcodes.

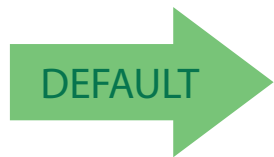

Code 32 = Disable



Code 32 = Enable

### Code 32 Feature Setting Exceptions



NOTE

The following features are set for Code 32 by using these Code 39 settings:

"Code 39 Quiet Zones" on page 129

"Code 39 Length Control" on page 130

### Code 32 Check Character Transmission

Enable this option to transmit the check character along with Code 32 barcode data.

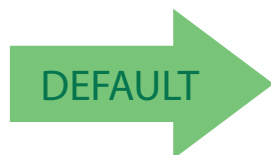

Code 32 Check Character Transmission = Don't Send



Code 32 Check Character Transmission = Send



## Code 32 Start/Stop Character Transmission

This option enables/disables transmission of Code 32 start and stop characters.

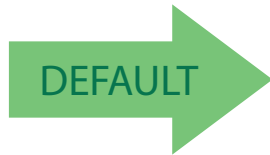

Code 32 Start/Stop Character Transmission = Don't Transmit



Code 32 Start/Stop Character Transmission = Transmit

## Code 39 CIP (French Pharmaceutical)

The following options apply to the Code 39 CIP symbology.

### Code 39 CIP Enable/Disable

Enables/Disables ability of the scanner to decode Code 39 CIP labels.

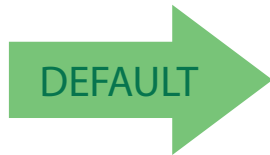

Code 39 CIP = Disable

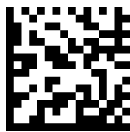

Code 39 CIP = Enable

## Code 128

The following options apply to the Code 128 symbology.

### Code 128 Enable/Disable

When disabled, the scanner will not read Code 128 barcodes.



### Expand Code 128 to Code 39

This feature enables/disables expansion of Code 128 labels to Code 39 labels. When enabled, the label identifier for a Code 128 label shall be set to Code 39 and all Code 39 formatting control shall be applied to the label.

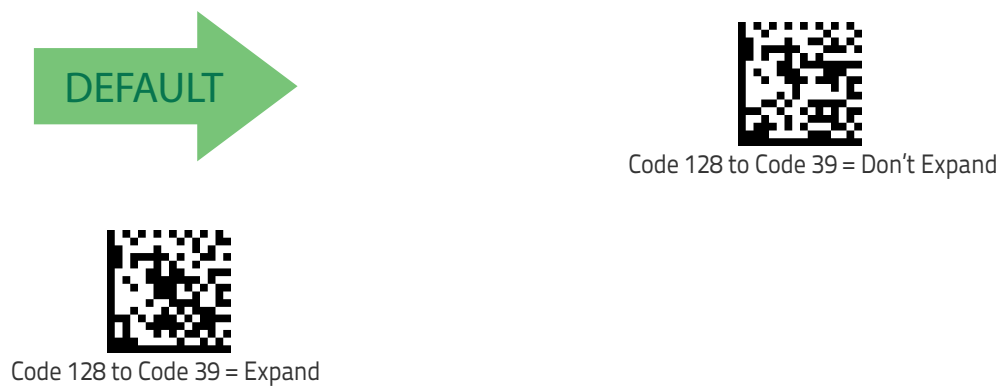



## Code 128 Check Character Transmission

Enable this option to transmit the check character along with Code 128 barcode data.

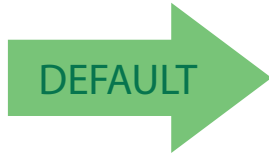

Code 128 Check Character Transmission = Don't Send



Code 128 Check Character Transmission = Send

## Code 128 Function Character Transmission

Enables/disables transmission of Code128 function characters 1, 2, 3, and 4.

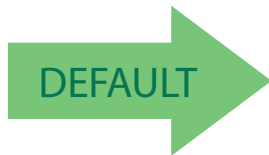

Code 128 Function Character Transmission = Don't Send



Code 128 Function Character Transmission = Send





## Code 128 Quiet Zones

This feature specifies the number of quiet zones for Code 128 labels. Quiet zones are blank areas at the ends of a barcode and are typically 10 times the width of the narrowest bar or space in the label.



Code 128 Quiet Zones = No Quiet Zones



Code 128 Quiet Zones = Quiet Zone on one side



Code 128 Quiet Zones = Quiet Zones on two sides



Code 128 Quiet Zones = Auto



Code 128 Quiet Zones = Virtual Quiet Zones on two sides



## Code 128 Length Control

This feature specifies either variable length decoding or fixed length decoding for the Code 128 symbology.

**Variable Length:** For variable length decoding, a minimum and maximum length may be set.

**Fixed Length:** For fixed length decoding, two different lengths may be set.

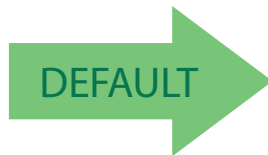

Code 128 Length Control = Variable Length



Code 128 Length Control = Fixed Length

## Code 128 Set Length 1

This feature specifies one of the barcode lengths for [Code 128 Length Control on page 138](#). Length 1 is the minimum label length if in [Variable Length on page 138 Mode](#), or the first fixed length if in [Fixed Length on page 138 Mode](#). Length includes the barcode's data characters only.

The length can be set from 1 to 80 characters. See ["Set Length 1" on page 248](#) for more detailed programming instructions.



Select Code 128 Set Length 1 Setting

To configure this feature, scan the ENTER/EXIT barcode above, then the barcode at left followed by digits from the Alphanumeric characters in [Appendix D, Keypad](#) representing your desired character(s). End by scanning the ENTER/EXIT barcode again.

Make a mistake? Scan the CANCEL barcode to abort and not save the entry string. You can then start again at the beginning.

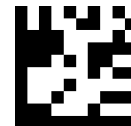

CANCEL

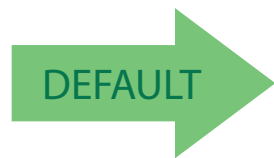

**01 = Length 1 is 1 Character**



## Code 128 Set Length 2

This feature specifies one of the barcode lengths for [Code 128 Length Control on page 138](#). Length 2 is the maximum label length if in [Variable Length on page 138 Mode](#), or the second fixed length if in [Fixed Length on page 138 Mode](#). Length includes the barcode's data characters only.

The length can be set from 1 to 80 characters. A setting of 00 specifies to ignore this length (only one fixed length). See "[Set Length 2](#)" on page 249 for more detailed programming instructions.



Select Code 128 Length 2 Setting

To configure this feature, scan the ENTER/EXIT barcode above, then the barcode at left followed by digits from the Alphanumeric characters in [Appendix D, Keypad](#) representing your desired character(s). End by scanning the ENTER/EXIT barcode again.

Make a mistake? Scan the CANCEL barcode to abort and not save the entry string. You can then start again at the beginning.



CANCEL

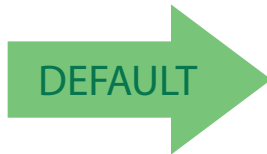

**80 = Length 2 is 80 Characters**

## GS1-128

The following options apply to the GS1-128 symbology. (Also known as USS-128, GTIN-128, UCC-128.)

### GS1-128 Enable

This option enables/disables the ability of the scanner to translate GS1-128 labels to the GS1-128 data format. Options are:

- Transmit GS1-128 labels in Code 128 data format.
- Transmit GS1-128 labels in GS1-128 data format.
- Do not transmit GS1-128 labels.



GS1-128 = Transmit in Code 128 data format



GS1-128 = Transmit in GS1-128 data format



GS1-128 = Do not transmit GS1-128 labels



## Interleaved 2 of 5 (I 2 of 5)

The following options apply to the I 2 of 5 symbology.



When reading this symbology, the settings for I 2 of 5 Length Control AND I 2 of 5 Check Character Calculation **MUST** be enabled to increase decoding safety.

### I 2 of 5 Enable/Disable

When disabled, the scanner will not read I 2 of 5 barcodes.

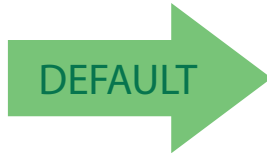

I 2 of 5 = Disable



I 2 of 5 = Enable



## I 2 of 5 Check Character Calculation

This option enables/disables calculation and verification of an optional I 2 of 5 check character.

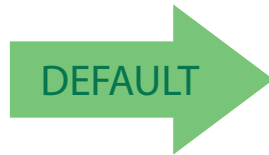

I 2 of 5 Check Char Calc = Disable



I 2 of 5 Check Char Calc = Check Standard  
(Modulo 10)



I 2 of 5 Check Char Calc = Check German Parcel



I 2 of 5 Check Char Calc = Check DHL



I 2 of 5 Check Char Calc = Check Daimler Chrysler



I 2 of 5 Check Char Calc = Check Bosch



I 2 of 5 Check Character Calculation = Check Italian Post

When disabled, any check character in label is treated as a data character.



## I 2 of 5 Check Character Transmission

Enable this option to transmit the check character along with I 2 of 5 barcode data.



**NOTE**

**This feature is valid only when I 2 of 5 Check Character Calculation is enabled.**



I 2 of 5 Check Character Transmission = Don't Send



I 2 of 5 Check Character Transmission = Send





## I 2 of 5 Length Control

This feature specifies either variable length decoding or fixed length decoding for the I 2 of 5 symbology.

**Variable Length:** For variable length decoding, a minimum and maximum length may be set.

**Fixed Length:** For fixed length decoding, two different lengths may be set.

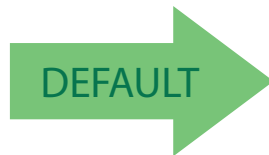

I 2 of 5 Length Control = Variable Length



I 2 of 5 Length Control = Fixed Length



## I 2 of 5 Set Length 1

This feature specifies one of the barcode lengths for I 2 of 5 Length Control on page 145. Length 1 is the minimum label length if in Variable Length on page 150 Mode, or the first fixed length if in Fixed Length on page 150 Mode. The length includes the barcode's check and data characters.

The length can be set from 2 to 50 characters in increments of two. See "Set Length 1" on page 248 for more detailed programming instructions.



Select I 2 of 5 Length 1 Setting

To configure this feature, scan the ENTER/EXIT barcode above, then the barcode at left followed by digits from the Alphanumeric characters in [Appendix D, Keypad](#) representing your desired character(s). End by scanning the ENTER/EXIT barcode again.

Make a mistake? Scan the CANCEL barcode to abort and not save the entry string. You can then start again at the beginning.



CANCEL

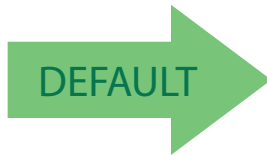

**06 = Length 1 is 6 Characters**

## I 2 of 5 Set Length 2

This feature specifies one of the barcode lengths for I 2 of 5 Length Control on page 145. Length 2 is the maximum label length if in Variable Length on page 145 Mode, or the second fixed length if in Fixed Length on page 145 Mode. The length includes the barcode's check and data characters.

The length can be set from 2 to 50 characters. A setting of 0 specifies to ignore this length (only one fixed length). See "Set Length 2" on page 249 for more detailed programming instructions.



Select I 2 of 5 Length 2 Setting

To configure this feature, scan the ENTER/EXIT barcode above, then the barcode at left followed by digits from the Alphanumeric characters in [Appendix D, Keypad](#) representing your desired character(s). End by scanning the ENTER/EXIT barcode again.

Make a mistake? Scan the CANCEL barcode to abort and not save the entry string. You can then start again at the beginning.

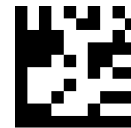

CANCEL

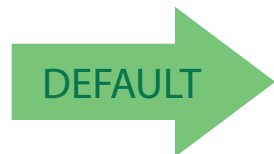

**50 = Length 2 is 50 Characters**



## Interleaved 2 of 5 CIP HR

The following options apply to the Interleaved 2 of 5 CIP HR symbology.

### Interleaved 2 of 5 CIP HR Enable/Disable

Enables/Disables ability of scanner to decode Interleaved 2 of 5 CIP HR labels.

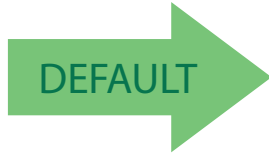

Interleaved 2 of 5 CIP HR = Disable



Interleaved 2 of 5 CIP HR = Enable

## Datalogic 2 of 5

The following options apply to the Datalogic 2 of 5 symbology.

### Datalogic 2 of 5 Enable/Disable

When disabled, the scanner will not read Datalogic 2 of 5 barcodes.

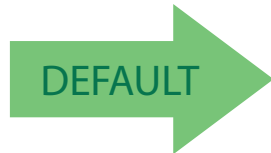

Datalogic 2 of 5 = Disable

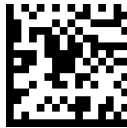

Datalogic 2 of 5 = Enable

### Datalogic 2 of 5 Check Character Calculation

This option enables/disables calculation and verification of an optional Datalogic 2 of 5 check character.

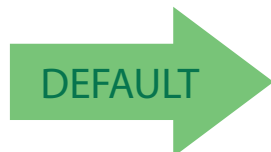

Datalogic 2 of 5 Check Character Calculation = Disable



Datalogic 2 of 5 Check Character Calculation = Enable



### Datalogic 2 of 5 Check Character Transmission

This option enables/disables transmission of an optional Datalogic 2 of 5 character.



Datalogic 2 of 5 Check Character Transmission = Don't Send



Datalogic 2 of 5 Check Character Transmission = Send

### Datalogic 2 of 5 Length Control

This feature specifies either variable length decoding or fixed length decoding for the Datalogic 2 of 5 symbology.

**Variable Length:** For variable length decoding, a minimum and maximum length may be set.

**Fixed Length:** For fixed length decoding, two different lengths may be set.



Datalogic 2 of 5 Length Control = Variable Length



Datalogic 2 of 5 Length Control = Fixed Length

## Datalogic 2 of 5 Set Length 1

This feature specifies one of the barcode lengths for [Datalogic 2 of 5 Length Control on page 150](#). Length 1 is the minimum label length if in [Variable Length on page 150](#) Mode, or the first fixed length if in [Fixed Length on page 150](#) Mode. The length includes the barcode's data characters only.

The length can be set from 2 to 50 characters in increments of one. See "[Set Length 1](#)" on page 248 for more detailed programming instructions.



Select Datalogic 2 of 5 Length 1 Setting

To configure this feature, scan the ENTER/EXIT barcode above, then the barcode at left followed by digits from the Alphanumeric characters in [Appendix D, Keypad](#) representing your desired character(s). End by scanning the ENTER/EXIT barcode again.

Make a mistake? Scan the CANCEL barcode to abort and not save the entry string. You can then start again at the beginning.

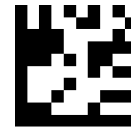

CANCEL



**06 = Length 1 is 6 Characters**



## Datalogic 2 of 5 Set Length 2

This feature specifies one of the barcode lengths for **Datalogic 2 of 5 Length Control** on page 150. Length 2 is the maximum label length if in **Variable Length** on page 150 Mode, or the second fixed length if in **Fixed Length** on page 150 Mode. The length includes the barcode's data characters only. The length can be set from 2 to 50 characters. A setting of 00 specifies to ignore this length (only one fixed length). See "**Set Length 2**" on page 249 for more detailed programming instructions.



Select Datalogic 2 of 5 Length 2 Setting

To configure this feature, scan the ENTER/EXIT barcode above, then the barcode at left followed by digits from the Alphanumeric characters in **Appendix D, Keypad** representing your desired character(s). End by scanning the ENTER/EXIT barcode again.

Make a mistake? Scan the CANCEL barcode to abort and not save the entry string. You can then start again at the beginning.

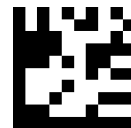

CANCEL

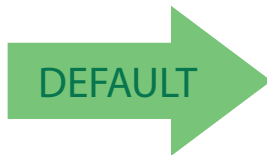

**50 = Length 2 is 50 Characters**



## Codabar

The following options apply to the Codabar symbology.

### Codabar Enable/Disable

When disabled, the scanner will not read Codabar barcodes.

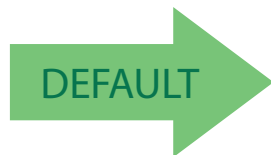

Codabar = Disable



Codabar = Enable

### Codabar Check Character Calculation

Enable this option to enables/disables calculation and verification of an optional Codabar check character. When disabled, any check characters in the label are treated as data characters.

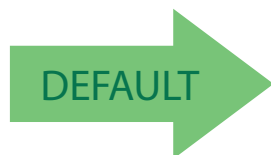

Codabar Check Character Calculation = Don't Calculate



Codabar Check Character Calculation = Enable AIM standard check char.



Codabar Check Character Calculation = Enable Modulo 10 check char.



## Codabar Check Character Transmission

Enable this option to transmit the check character along with Codabar barcode data.



This feature is valid only when Codabar Check Character Calculation is enabled.

**NOTE**



Codabar Check Character Transmission = Don't Send



Codabar Check Character Transmission = Send



## Codabar Start/Stop Character Transmission

Enable this option to enable/disable transmission of Codabar start and stop characters.



Codabar Start/Stop Character Transmission = Don't Transmit



Codabar Start/Stop Character Transmission = Transmit





## Codabar Start/Stop Character Set

This option specifies the format of transmitted Codabar start/stop characters.



Codabar Start/Stop Character Set = ABCD/TN\*E



Codabar Start/Stop Character Set = ABCD/ABCD



Codabar Start/Stop Character Set = abcd/tn\*e



Codabar Start/Stop Character Set = abcd/abcd



## Codabar Start/Stop Character Match

When enabled, this option requires that start and stop characters match.

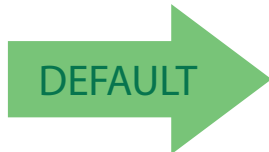

Codabar Start/Stop Character Match = Don't Require Match



Codabar Start/Stop Character Match = Require Match



## Codabar Quiet Zones

This feature specifies the number of quiet zones for Codabar labels. Quiet zones are blank areas at the ends of a barcode and are typically 10 times the width of the narrowest bar or space in the label.



Codabar Quiet Zones = Quiet Zone on one side



Codabar Quiet Zones = Quiet Zones on two sides



Codabar Quiet Zones = Auto

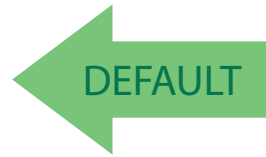

Codabar Quiet Zones = Virtual Quiet Zones on two sides



Codabar Quiet Zones = Small Quiet Zones on two sides

## Codabar Length Control

This feature specifies either variable length decoding or fixed length decoding for the Codabar symbology.

**Variable Length:** For variable length decoding, a minimum and maximum length may be set.

**Fixed Length:** For fixed length decoding, two different lengths may be set.

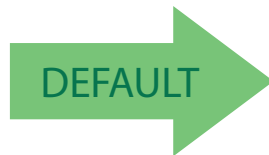

Codabar Length Control = Variable Length



Codabar Length Control = Fixed Length



## Codabar Set Length 1

This feature specifies one of the barcode lengths for [Codabar Length Control on page 157](#). Length 1 is the minimum label length if in [Variable Length on page 157 Mode](#), or the first fixed length if in [Fixed Length on page 157 Mode](#). Length includes the barcode's start, stop, check and data characters. The length must include at least one data character.

The length can be set from 3 to 50 characters. See "[Set Length 1](#)" on page 248 for more detailed programming instructions.



Select Codabar Length 1 Setting

To configure this feature, scan the ENTER/EXIT barcode above, then the barcode at left followed by digits from the Alphanumeric characters in [Appendix D, Keypad](#) representing your desired character(s). End by scanning the ENTER/EXIT barcode again.

Make a mistake? Scan the CANCEL barcode to abort and not save the entry string. You can then start again at the beginning.



CANCEL

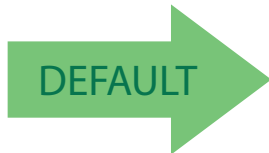

**03 = Length 1 is 3 Characters**

## Codabar Set Length 2

This feature specifies one of the barcode lengths for [Codabar Length Control on page 157](#). Length 2 is the maximum label length if in [Variable Length on page 157 Mode](#), or the second fixed length if in [Fixed Length on page 157 Mode](#). The length includes the barcode's start, stop, check and data characters. The length must include at least one data character.

The length can be set from 3 to 50 characters. A setting of 00 specifies to ignore this length (only one fixed length). See ["Set Length 2" on page 249](#) for more detailed programming instructions.



Select Codabar Length 2 Setting

To configure this feature, scan the ENTER/EXIT barcode above, then the barcode at left followed by digits from the Alphanumeric characters in [Appendix D, Keypad](#) representing your desired character(s). End by scanning the ENTER/EXIT barcode again.

Make a mistake? Scan the CANCEL barcode to abort and not save the entry string. You can then start again at the beginning.

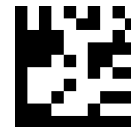

CANCEL

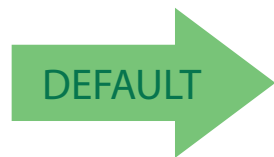

**50 = Length 2 is 50 Characters**



## ABC Codabar

The following options apply to the ABC Codabar symbology.

### ABC Codabar Enable/Disable

Enables/Disables ability of scanner to decode ABC Codabar labels.

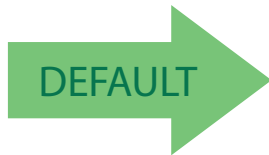

ABC Codabar = Disable



ABC Codabar = Enable

### ABC Codabar Concatenation Mode

Specifies the concatenation mode between Static and Dynamic.

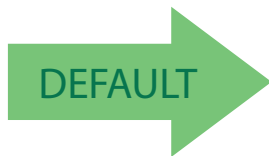

ABC Codabar Concatenation Mode = Static



ABC Codabar Concatenation Mode = Dynamic



## ABC Codabar Dynamic Concatenation Timeout

This parameter specifies the timeout in 10–millisecond ticks used by the ABC Codabar Dynamic Concatenation Mode. The timeout can be set within a range of 05 to 255 in 10ms increments. A setting of zero specifies no delay.



Select ABC Codabar Dynamic Concatenation Timeout Setting

To configure this feature, scan the ENTER/EXIT barcode above, then the barcode at left followed by digits from the Alphanumeric characters in [Appendix D, Keypad](#) representing your desired character(s). End by scanning the ENTER/EXIT barcode again.

Make a mistake? Scan the CANCEL barcode to abort and not save the entry string. You can then start again at the beginning.



CANCEL

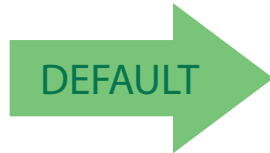

**14 (0x14) = Quiet Interval of 200 ms**

## ABC Codabar Force Concatenation

Forces labels starting or ending with D to be concatenated.

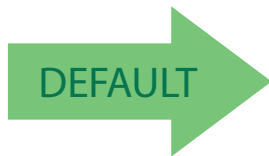

ABC Codabar Force Concatenation = Disable



ABC Codabar Force Concatenation = Enable



## Code 11

The following options apply to the Code 11 symbology.

### Code 11 Enable/Disable

When disabled, the scanner will not read Code 11 barcodes.

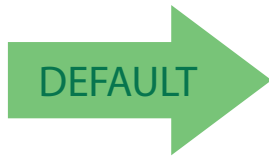

Code 11 = Disable



Code 11 = Enable

## Code 11 Check Character Calculation

This option enables/disables calculation and verification of optional Code 11 check character.



Code 11 Check Character Calculation = Disable



Code 11 Check Character Calculation = Check C



Code 11 Check Character Calculation = Check K



Code 11 Check Character Calculation = Check C and K



## Code 11 Check Character Transmission

This feature enables/disables transmission of an optional Code 11 check character.



Code 11 Check Character Transmission = Don't Send



Code 11 Check Character Transmission = Send





## Code 11 Length Control

This feature specifies either variable length decoding or fixed length decoding for the Code 11 symbology.

**Variable Length:** For variable length decoding, a minimum and maximum length may be set.

**Fixed Length:** For fixed length decoding, two different lengths may be set.

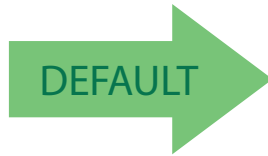

Code 11 Length Control = Variable Length



Code 11 Length Control = Fixed Length

## Code 11 Set Length 1

This feature specifies one of the barcode lengths for [Code 11 Length Control on page 164](#). Length 1 is the minimum label length if in [Variable Length on page 164 Mode](#), or the first fixed length if in [Fixed Length on page 164 Mode](#). Length includes the barcode's check and data characters.

The length can be set from 2 to 50 characters. See "[Set Length 1](#)" on page 248 for more detailed programming instructions.



Select Code 11 Set Length 1 Setting

To configure this feature, scan the ENTER/EXIT barcode above, then the barcode at left followed by digits from the Alphanumeric characters in [Appendix D, Keypad](#) representing your desired character(s). End by scanning the ENTER/EXIT barcode again.

Make a mistake? Scan the CANCEL barcode to abort and not save the entry string. You can then start again at the beginning.



CANCEL



## Code 11 Set Length 2

This feature specifies one of the barcode lengths for [Code 11 Length Control on page 164](#). Length 2 is the maximum label length if in [Variable Length on page 164 Mode](#), or the second fixed length if in [Fixed Length on page 164 Mode](#). Length includes the barcode's check and data characters.

The length can be set from 2 to 50 characters. A setting of 00 specifies to ignore this length (only one fixed length). See "[Set Length 2](#)" on page 249 for more detailed programming instructions.



Select Code 11 Length 2 Setting

To configure this feature, scan the ENTER/EXIT barcode above, then the barcode at left followed by digits from the Alphanumeric characters in [Appendix D, Keypad](#) representing your desired character(s). End by scanning the ENTER/EXIT barcode again.

Make a mistake? Scan the CANCEL barcode to abort and not save the entry string. You can then start again at the beginning.

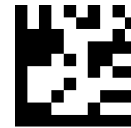

CANCEL





## Standard 2 of 5

The following options apply to the Standard 2 of 5 symbology.

### Standard 2 of 5 Enable/Disable

When disabled, the scanner will not read Standard 2 of 5 barcodes.

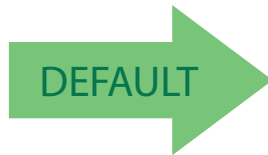

Standard 2 of 5 = Disable



Standard 2 of 5 = Enable

### Standard 2 of 5 Check Character Calculation

This option enables/disables calculation and verification of an optional Standard 2 of 5 check character.

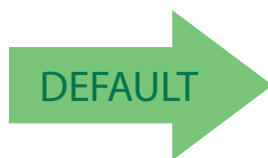

Standard 2 of 5 Check Character Calculation = Disable



Standard 2 of 5 Check Character Calculation = Enable

## Standard 2 of 5 Check Character Transmission

This feature enables/disables transmission of an optional Standard 2 of 5 check character.

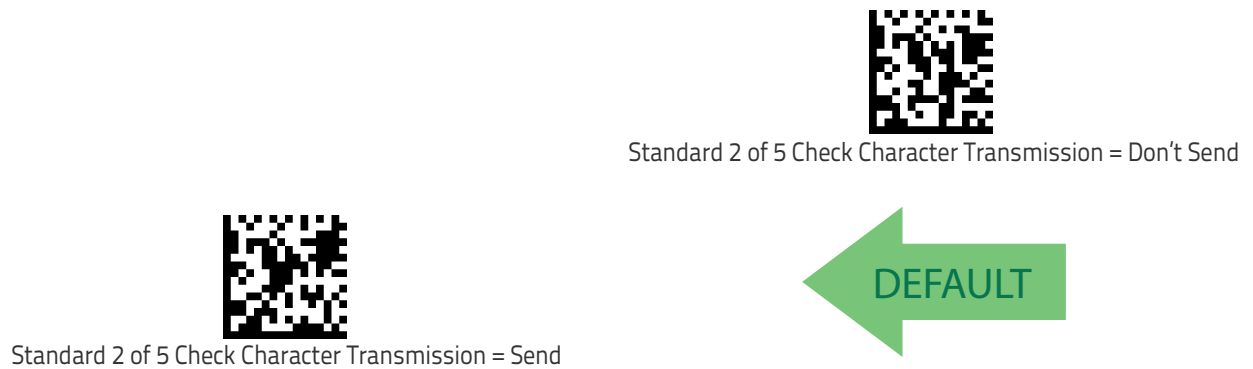

## Standard 2 of 5 Length Control

This feature specifies either variable length decoding or fixed length decoding for the Standard 2 of 5 symbology.

**Variable Length:** For variable length decoding, a minimum and maximum length may be set.

**Fixed Length:** For fixed length decoding, two different lengths may be set.

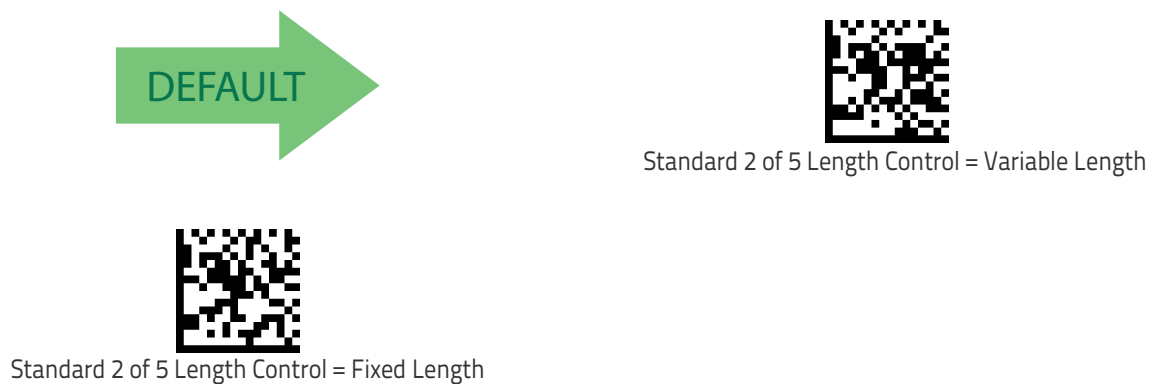



## Standard 2 of 5 Set Length 1

This feature specifies one of the barcode lengths for [Standard 2 of 5 Length Control on page 167](#). Length 1 is the minimum label length if in [Variable Length on page 167 Mode](#), or the first fixed length if in [Fixed Length on page 167 Mode](#). Length includes the barcode's check and data characters.

The length can be set from 1 to 50 characters. See "[Set Length 1](#)" on page 248 for more detailed programming instructions.



Select Standard 2 of 5 Length 1 Setting

To configure this feature, scan the ENTER/EXIT barcode above, then the barcode at left followed by digits from the Alphanumeric characters in [Appendix D, Keypad](#) representing your desired character(s). End by scanning the ENTER/EXIT barcode again.

Make a mistake? Scan the CANCEL barcode to abort and not save the entry string. You can then start again at the beginning.

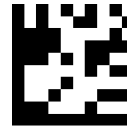

CANCEL

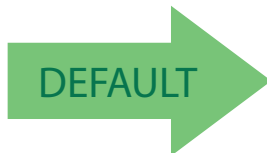

**08 = Length 1 is 8 Characters**



## Standard 2 of 5 Set Length 2

This feature specifies one of the barcode lengths for **Standard 2 of 5 Length Control** on page 167. Length 2 is the maximum label length if in **Variable Length** on page 167 Mode, or the second fixed length if in **Fixed Length** on page 167 Mode. Length includes the barcode's check and data characters. The length can be set from 1 to 50 characters. A setting of 00 specifies to ignore this length (only one fixed length). See "**Set Length 2**" on page 249 for more detailed programming instructions.



Select Standard 2 of 5 Length 2 Setting

To configure this feature, scan the ENTER/EXIT barcode above, then the barcode at left followed by digits from the Alphanumeric characters in **Appendix D, Keypad** representing your desired character(s). End by scanning the ENTER/EXIT barcode again.

Make a mistake? Scan the CANCEL barcode to abort and not save the entry string. You can then start again at the beginning.

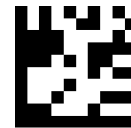

CANCEL

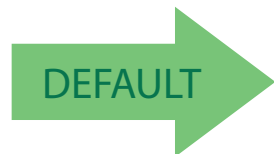

**50 = Length 2 is 50 Characters**



## Industrial 2 of 5

The following options apply to the Industrial 2 of 5 symbology.

### Industrial 2 of 5 Enable/Disable

Enables/Disables ability of scanner to decode Industrial 2 of 5 labels.

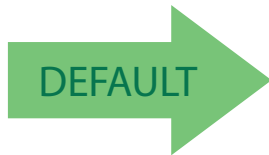

Industrial 2 of 5 = Disable



Industrial 2 of 5 = Enable

### Industrial 2 of 5 Check Character Calculation

Enables/Disables calculation and verification of an optional Industrial 2 of 5 check character.

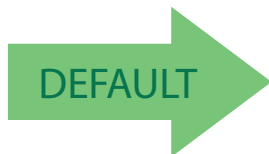

Industrial 2 of 5 Check Character Calculation = Disable



Industrial 2 of 5 Check Character Calculation = Enable

## Industrial 2 of 5 Check Character Transmission

Enables/disables transmission of an Industrial 2 of 5 check character.

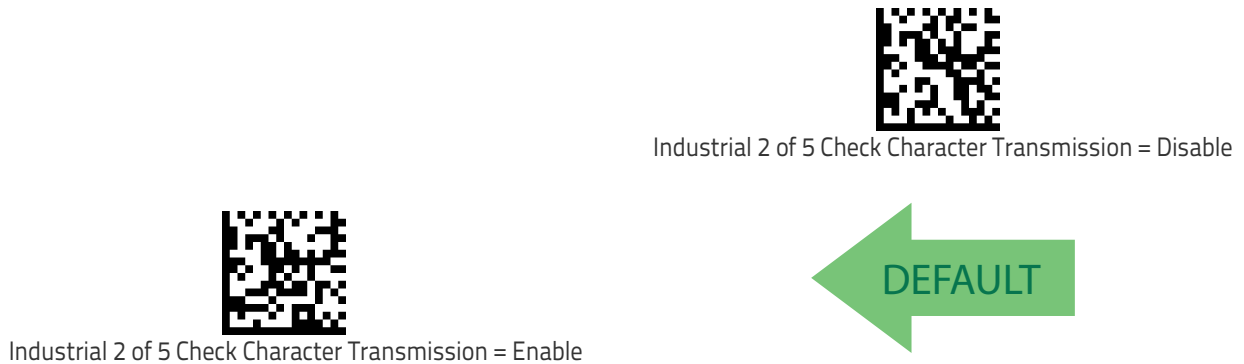

## Industrial 2 of 5 Length Control

This feature specifies either variable length decoding or fixed length decoding for the Industrial 2 of 5 symbology.

**Variable Length:** For variable length decoding, a minimum and maximum length may be set.

**Fixed Length:** For fixed length decoding, two different lengths may be set.

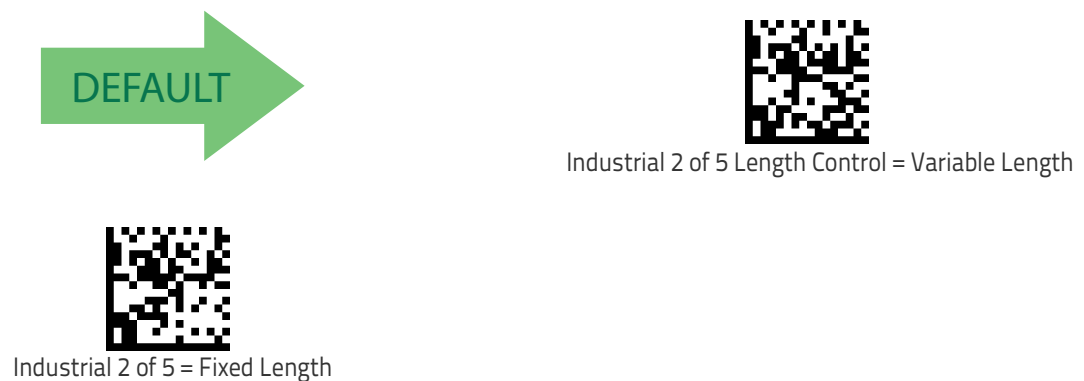



## Industrial 2 of 5 Set Length 1

This feature specifies one of the barcode lengths for [Industrial 2 of 5 Length Control on page 171](#). Length 1 is the minimum label length if in [Variable Length on page 171 Mode](#), or the first fixed length if in [Fixed Length on page 171 Mode](#). Length includes the barcode's check and data characters.

The length can be set from 1 to 50 characters. See "[Set Length 1](#)" on page 248 for more detailed programming instructions.



Select Industrial 2 of 5 Set Length 1 Setting

To configure this feature, scan the ENTER/EXIT barcode above, then the barcode at left followed by digits from the Alphanumeric characters in [Appendix D, Keypad](#) representing your desired character(s). End by scanning the ENTER/EXIT barcode again.

Make a mistake? Scan the CANCEL barcode to abort and not save the entry string. You can then start again at the beginning.



CANCEL

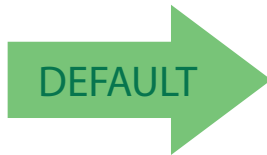

**01 = Length 1 is 1 Character**

## Industrial 2 of 5 Set Length 2

This feature specifies one of the barcode lengths for **Industrial 2 of 5 Length Control** on page 171. Length 2 is the maximum label length if in **Variable Length** on page 130 Mode, or the second fixed length if in **Fixed Length** on page 130 Mode. Length includes the barcode's check, data, and full-ASCII shift characters. The length does not include start/stop characters.

The length can be set from 1 to 50 characters. A setting of 00 specifies to ignore this length (only one fixed length). See "**Set Length 2**" on page 249 for more detailed programming instructions.



Select Industrial 2 of 5 Length 2 Setting

To configure this feature, scan the ENTER/EXIT barcode above, then the barcode at left followed by digits from the Alphanumeric characters in **Appendix D, Keypad** representing your desired character(s). End by scanning the ENTER/EXIT barcode again.

Make a mistake? Scan the CANCEL barcode to abort and not save the entry string. You can then start again at the beginning.



CANCEL

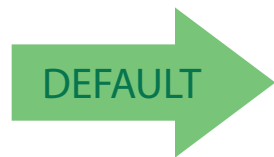

**50 = Length 2 is 50 Characters**



## IATA

The following options apply to the IATA symbology.

### IATA Enable/Disable

Enables/Disables the ability of the scanner to decode IATA labels.

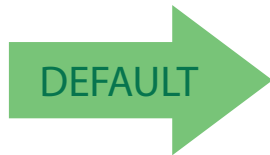

IATA = Disable



IATA = Enable

### IATA Check Character Transmission

Enables/Disables calculation and verification of an optional Industrial 2 of 5 check character.



IATA Check Character Transmission = Disable



IATA Check Character Transmission = Enable



## ISBT 128

The following options apply to the ISBT 128 symbology.

### ISBT 128 Concatenation

Enables/disables ISBT128 concatenation of 2 labels.

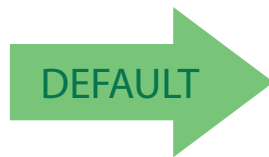

ISBT 128 Concatenation = Disable



ISBT 128 Concatenation = Enable

### ISBT 128 Concatenation Mode

Specifies the concatenation mode between Static and Dynamic.



**NOTE**

This option is only valid when ISBT 128 Concatenation on page 175 is enabled (see page 9-175).

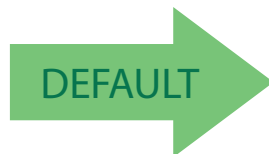

ISBT 128 Concatenation Mode = Static



ISBT 128 Concatenation Mode = Dynamic



## ISBT 128 Dynamic Concatenation Timeout

Specifies the timeout used by the ISBT 128 Dynamic Concatenation Mode.



ISBT 128 Dynamic Concatenation Timeout = 50 msec



ISBT 128 Dynamic Concatenation Timeout = 100 msec

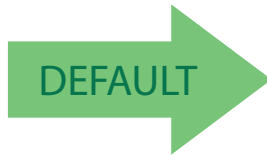

ISBT 128 Dynamic Concatenation Timeout = 200 msec



ISBT 128 Dynamic Concatenation Timeout = 500 msec



ISBT 128 Dynamic Concatenation Timeout = 750 msec



ISBT 128 Dynamic Concatenation Timeout = 1 second



## ISBT 128 Force Concatenation

When enabled, this feature forces all ISBT 128 labels to be concatenated.



**NOTE**

This option is only valid when ISBT 128 Concatenation on page 175 is enabled. (see page 9-175).

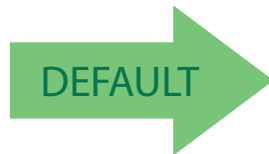

ISBT 128 Force Concatenation = Disable



ISBT 128 Force Concatenation = Enable

## ISBT 128 Advanced Concatenation Options



**NOTE**

Use the Datalogic Aladdin configuration application or Contact Customer Support to set up pairs of label types for concatenation.



# MSI

The following options apply to the MSI symbology.

## MSI Enable/Disable

Enables/Disables ability of scanner to decode MSI labels.

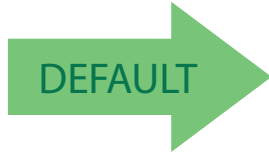

MSI = Disable



MSI = Enable

## MSI Check Character Calculation

Enables/Disables calculation and verification of an optional MSI check character.



MSI Check Character Calculation = Disable



MSI Check Character Calculation = Enable Mod10



MSI Check Character Calculation = Enable Mod11/10



MSI Check Character Calculation = Enable Mod10/10

## MSI Check Character Transmission

Enables/disables transmission of an MSI check character.

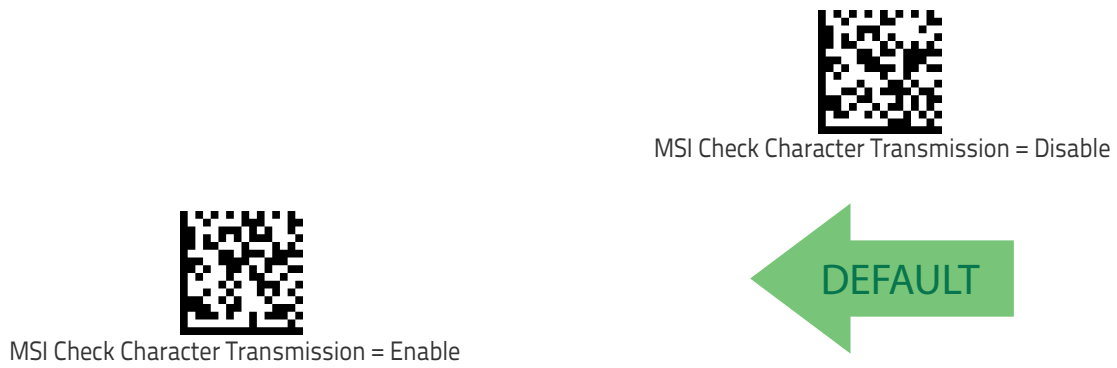

## MSI Length Control

This feature specifies either variable length decoding or fixed length decoding for the MSI symbology.

**Variable Length:** For variable length decoding, a minimum and maximum length may be set.

**Fixed Length:** For fixed length decoding, two different lengths may be set.

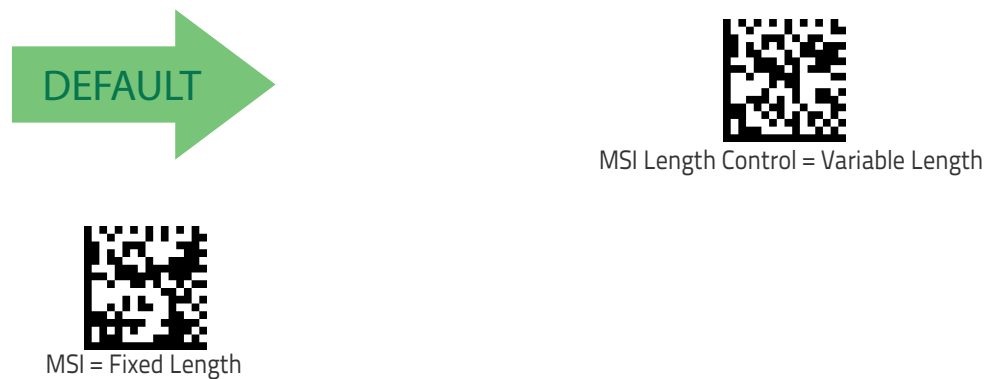



## MSI Set Length 1

This feature specifies one of the barcode lengths for [MSI Length Control on page 179](#). Length 1 is the minimum label length if in [Variable Length on page 179 Mode](#), or the first fixed length if in [Fixed Length on page 179 Mode](#). Length includes the barcode's data characters only.

The length can be set from 01 to 50 characters. See "[Set Length 1](#)" on page 248 for more detailed programming instructions.



Select MSI Set Length 1 Setting

To configure this feature, scan the ENTER/EXIT barcode above, then the barcode at left followed by digits from the Alphanumeric characters in [Appendix D, Keypad](#) representing your desired character(s). End by scanning the ENTER/EXIT barcode again.

Make a mistake? Scan the CANCEL barcode to abort and not save the entry string. You can then start again at the beginning.



CANCEL



**01 = Length 1 is 1 Character**

## MSI Set Length 2

This feature specifies one of the barcode lengths for [MSI Length Control on page 179](#). Length 2 is the maximum label length if in [Variable Length on page 179 Mode](#), or the second fixed length if in [Fixed Length on page 179 Mode](#). Length includes the barcode's check, data, and full-ASCII shift characters. The length does not include start/stop characters.

The length can be set from 1 to 50 characters. A setting of 0 specifies to ignore this length (only one fixed length). See "[Set Length 2](#)" on page 249 for more detailed programming instructions.



Select MSI Length 2 Setting

To configure this feature, scan the ENTER/EXIT barcode above, then the barcode at left followed by digits from the Alphanumeric characters in [Appendix D, Keypad](#) representing your desired character(s). End by scanning the ENTER/EXIT barcode again.

Make a mistake? Scan the CANCEL barcode to abort and not save the entry string. You can then start again at the beginning.



CANCEL

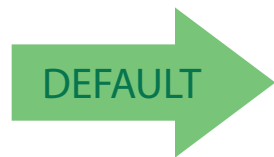

**50 = Length 2 is 50 Characters**



## Code 93

The following options apply to the Code 93 symbology.

### Code 93 Enable/Disable

Enables/Disables ability of scanner to decode Code 93 labels.

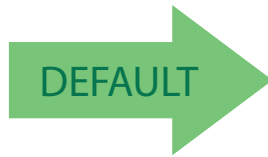

Code 93 = Disable



Code 93 = Enable

## Code 93 Check Character Calculation

Enables/disables calculation and verification of an optional Code 93 check character.



Code 93 Check Character Calculation = Disable



Code 93 Check Character Calculation = Enable Check C



Code 93 Check Character Calculation = Enable Check K



Code 93 Check Character Calculation =  
Enable Check C and K



## Code 93 Check Character Transmission

Enables/disables transmission of an optional Code 93 check character.



Code 93 Check Character Transmission = Disable



Code 93 Check Character Transmission = Enable





## Code 93 Length Control

This feature specifies either variable length decoding or fixed length decoding for the Code 93 symbology.

**Variable Length:** For variable length decoding, a minimum and maximum length may be set.

**Fixed Length:** For fixed length decoding, two different lengths may be set.

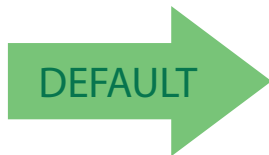

Code 93 Length Control = Variable Length



Code 93 = Fixed Length



## Code 93 Set Length 1

This feature specifies one of the barcode lengths for **Code 93 Length Control** on page 184. Length 1 is the minimum label length if in **Variable Length** on page 184 Mode, or the first fixed length if in **Fixed Length** on page 184 Mode. Length includes the barcode's data characters only.

The length can be set from 01 to 50 characters. See "Set Length 1" on page 248 for more detailed programming instructions.



Select Code 93 Set Length 1 Setting

To configure this feature, scan the ENTER/EXIT barcode above, then the barcode at left followed by digits from the Alphanumeric characters in **Appendix D, Keypad** representing your desired character(s). End by scanning the ENTER/EXIT barcode again.

Make a mistake? Scan the CANCEL barcode to abort and not save the entry string. You can then start again at the beginning.

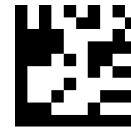

CANCEL

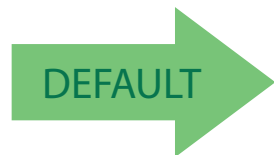

**01 = Length 1 is 1 Character**



## Code 93 Set Length 2

This feature specifies one of the barcode lengths for [Code 93 Length Control on page 184](#). Length 2 is the maximum label length if in [Variable Length on page 184 Mode](#), or the second fixed length if in [Fixed Length on page 184 Mode](#). Length includes the barcode's check, data, and full-ASCII shift characters. The length does not include start/stop characters.

The length can be set from 1 to 50 characters. A setting of 00 specifies to ignore this length (only one fixed length). See ["Set Length 2" on page 249](#) for more detailed programming instructions.



Select Code 93 Length 2 Setting

To configure this feature, scan the ENTER/EXIT barcode above, then the barcode at left followed by digits from the Alphanumeric characters in [Appendix D, Keypad](#) representing your desired character(s). End by scanning the ENTER/EXIT barcode again.

Make a mistake? Scan the CANCEL barcode to abort and not save the entry string. You can then start again at the beginning.



CANCEL

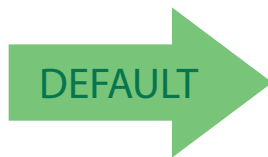

**50 = Length 2 is 50 Characters**

## Code 93 Quiet Zones

Enables/disables fixed length stitching for Code 93.



**NOTE**

This feature is available only on the TD1130 model.



Code 93 Quiet Zones = No Quiet Zones



Code 93 Quiet Zones = Quiet Zone on one side



Code 93 Quiet Zones = Quiet Zones on two sides



Code 93 Quiet Zones = Auto



DEFAULT



Code 93 Quiet Zones = Virtual Quiet Zones on two sides



## Follett 2 of 5

The following options apply to the Follett 2 of 5 symbology.

### Follett 2 of 5 Enable/Disable

Enables/Disables ability of scanner to decode Follett 2 of 5 labels.

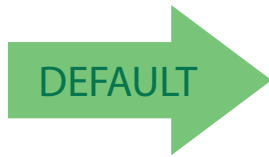

Follett 2 of 5 = Disable



Follett 2 of 5 = Enable

## BC412

The following options apply to the BC412 symbology.

### BC412 Enable/Disable

Enables/Disables ability of scanner to decode BC412 labels.

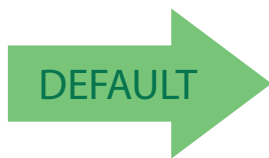

BC412 = Disable



BC412 = Enable



## BC412 Check Character Calculation

Enable this option to enable/disable calculation and verification of an optional BC412 check character. When disabled, any check character in the label is treated as a data character.

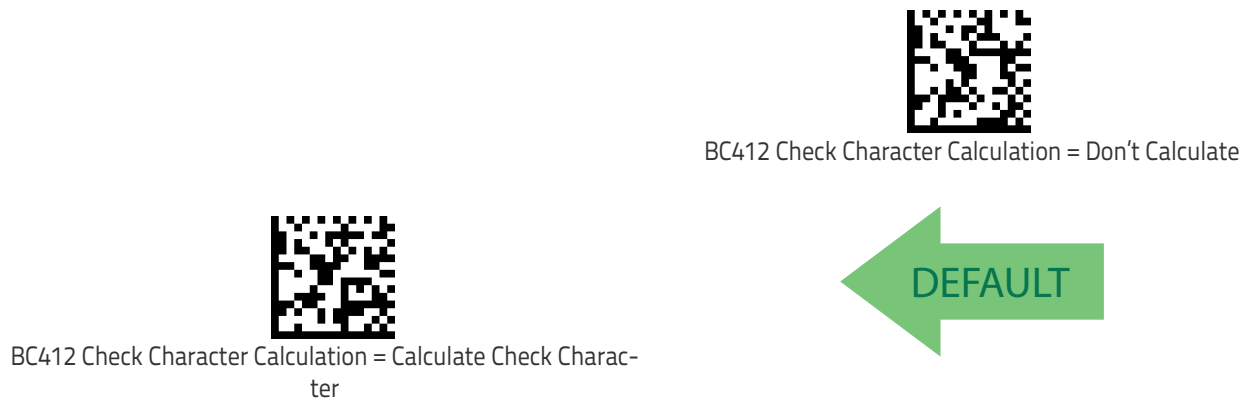

## BC412 Length Control

This feature specifies either variable length decoding or fixed length decoding for the BC412 symbology.

**Variable Length:** For variable length decoding, a minimum and maximum length may be set.

**Fixed Length:** For fixed length decoding, two different lengths may be set.

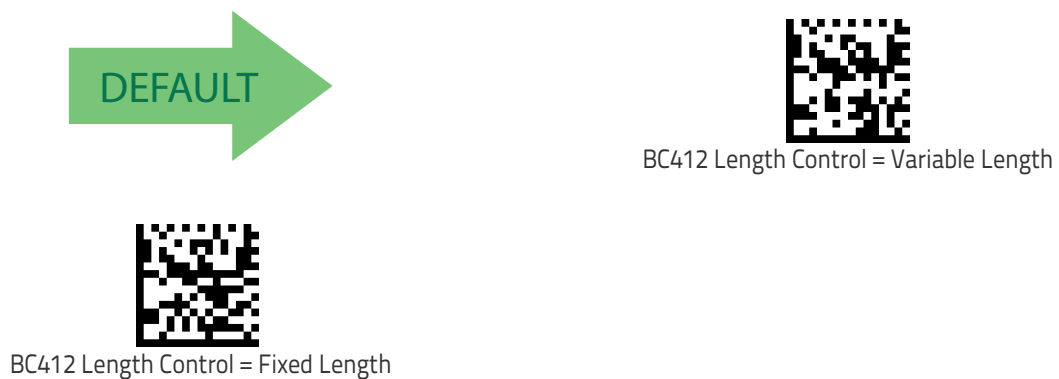



## BC412 Set Length 1

This feature specifies one of the barcode lengths for [BC412 Length Control on page 189](#). Length 1 is the minimum label length if in [Variable Length on page 189 Mode](#), or the first fixed length if in [Fixed Length on page 189 Mode](#). Length includes the barcode's data characters only.

The length can be set from 01 to 50 characters. See "[Set Length 1](#)" on page 248 for more detailed programming instructions.

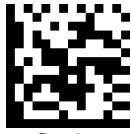

Select BC412 Set Length 1 Setting

To configure this feature, scan the ENTER/EXIT barcode above, then the barcode at left followed by digits from the Alphanumeric characters in [Appendix D, Keypad](#) representing your desired character(s). End by scanning the ENTER/EXIT barcode again.

Make a mistake? Scan the CANCEL barcode to abort and not save the entry string. You can then start again at the beginning.



CANCEL

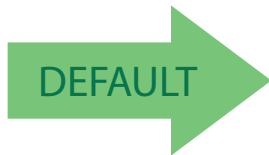

**01 = Length 1 is 1 Character**



## BC412 Set Length 2

This feature specifies one of the barcode lengths for [BC412 Length Control on page 189](#). Length 2 is the maximum label length if in [Variable Length on page 189 Mode](#), or the second fixed length if in [Fixed Length on page 189 Mode](#). Length includes the barcode's check, data, and full-ASCII shift characters. The length does not include start/stop characters.

The length can be set from 1 to 50 characters. A setting of 00 specifies to ignore this length (only one fixed length). See ["Set Length 2" on page 249](#) for more detailed programming instructions.



Select BC412 Length 2 Setting

To configure this feature, scan the ENTER/EXIT barcode above, then the barcode at left followed by digits from the Alphanumeric characters in [Appendix D, Keypad](#) representing your desired character(s). End by scanning the ENTER/EXIT barcode again.

Make a mistake? Scan the CANCEL barcode to abort and not save the entry string. You can then start again at the beginning.

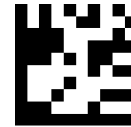

CANCEL

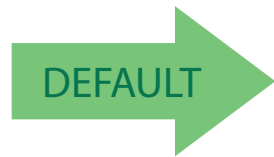

**50 = Length 2 is 50 Characters**



---

# NOTES



# 2D Symbologies

2D Global Features	
• 2D Maximum Decoding Time on page 194	• 2D Normal/Inverse Symbol Control on page 195
• 2D Structured Append on page 195	

The reader supports the following 2D symbologies (barcode types). Symbology-dependent options for each symbology are included in this chapter. See "1D Symbologies" starting on page 105 for configuration of 1D barcodes.

2D Symbologies	
• Aztec Code on page 196	• Micro PDF417 on page 211
• China Sensible Code on page 199	• QR Code on page 214
• Data Matrix on page 202	• Micro QR Code on page 217
• Maxicode on page 205	• UCC Composite on page 220
• PDF417 on page 208	• Postal Code Selection on page 222

## 2D Global Features

The following features are common to all, or in some cases, most of the available 2D symbologies. Default settings are indicated at each feature/option with a green arrow. Also reference [Appendix B, Standard Defaults](#) for a listing of the most widely used set of standard factory settings. That section also provides space to record any custom settings needed or implemented for your system.

To set most features:

1. Scan the ENTER/EXIT PROGRAMMING barcode at the top of applicable programming pages.
2. Scan the correct barcode to set the desired programming feature or parameter. You may need to cover unused barcodes on the page, and possibly the facing page, to ensure that the reader reads only the barcode you intend to scan.
3. If additional input parameters are needed, go to [Appendix D, Keypad](#), and scan the appropriate characters from the keypad.



**NOTE**

Additional information about many features can be found in the "References" chapter.

If you make a mistake before the last character, scan the CANCEL barcode to abort and not save the entry string. You can then start again at the beginning.

Complete the programming sequence by scanning the ENTER/EXIT PROGRAMMING barcode to exit Programming Mode.



## 2D Maximum Decoding Time

This feature specifies the maximum amount of time the software will spend attempting to decode a 2D label. The selectable range is 10 milliseconds to 255 milliseconds.



2D Maximum Decoding Time = 100 msec



2D Maximum Decoding Time = 200 msec



2D Maximum Decoding Time = 350 msec



2D Maximum Decoding Time = 500 msec



2D Maximum Decoding Time = 1 Second



2D Maximum Decoding Time = 2 Seconds



2D Maximum Decoding Time = 2.55 Seconds



## 2D Structured Append

Enables/disables ability of reader to append multiple 2D Codes labels in a structured format. The structured append property is globally applied to the following symbologies, if these are enabled:

- Data Matrix
- QR Code
- Aztec
- PDF 417

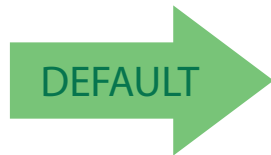

Structured Append = Disable



Structured Append = Enable

## 2D Normal/Inverse Symbol Control

Specifies the options available for decoding normal/negative printed 2D symbols. This configuration item applies globally to all the 2D symbologies that support that feature according to Standard AIM Specification: Data Matrix, QR, MicroQR, Aztec and Chinese Sensible Code.

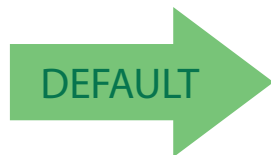

Normal/Inverse Symbol Control = Normal



Normal/Inverse Symbol Control = Inverse



Normal/Inverse Symbol Control =  
Both Normal and Inverse



# Symbology Selection

## Aztec Code

### Aztec Code Enable / Disable

Enables/disables the ability of the reader to decode Aztec Code labels.

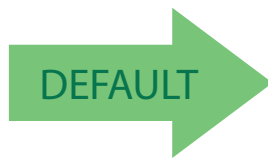

Aztec Code = Disable



Aztec Code = Enable

### Aztec Code Length Control

This feature specifies either variable length decoding or fixed length decoding for this symbology.

**Variable Length:** For variable length decoding, a minimum and maximum length may be set.

**Fixed Length:** For fixed length decoding, two different lengths may be set.

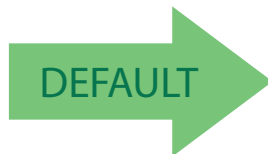

Aztec Code Length Control = Variable Length



Aztec Code Length Control = Fixed Length



## Aztec Code Set Length 1

Specifies one of the barcode lengths for [Aztec Code Length Control on page 196](#). Length 1 is the minimum label length if in [Variable Length Mode](#), or the first fixed length if in [Fixed Length Mode](#). Characters can be set from 0001 to 3,832 characters in increments of 0001 (pad with zeroes).

See [page 248](#) for detailed instructions on setting this feature.



Select Aztec Code Length 1 Setting

To configure this feature, scan the ENTER/EXIT PROGRAMMING MODE barcode above, then the barcode at left followed by the digits from the Alphanumeric characters in [Appendix D, Keypad](#) representing your desired character(s). End by scanning the ENTER/EXIT barcode again.

Make a mistake? Scan the CANCEL barcode to abort and not save the entry string. You can then start again at the beginning.

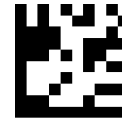

CANCEL

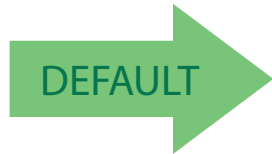

**0001 = Length 1 is 1 Character**



## Aztec Code Set Length 2

This feature specifies one of the barcode lengths for [Aztec Code Length Control on page 196](#). Length 2 is the maximum label length if in Variable Length Mode, or the second fixed length if in Fixed Length Mode. Characters can be set from 0001 to 3,832 characters in increments of 0001 (pad with zeroes).

See [page 249](#) for detailed instructions on setting this feature.



Select Aztec Code Length 2 Setting

To configure this feature, scan the ENTER/EXIT PROGRAMMING MODE barcode above, then the barcode at left followed by the digits from the Alphanumeric characters in [Appendix D, Keypad](#) representing your desired character(s). End by scanning the ENTER/EXIT barcode again.

Make a mistake? Scan the CANCEL barcode to abort and not save the entry string. You can then start again at the beginning.

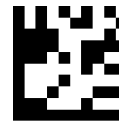

CANCEL

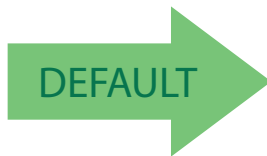

**Length 2 is 3,832 Characters**

## China Sensible Code

### China Sensible Code Enable / Disable

Enables/disables the ability of the reader to decode China Sensible Code labels.

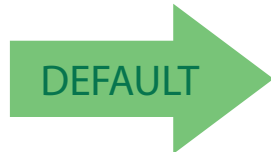

China Sensible Code = Disable



China Sensible Code = Enable

### China Sensible Code Length Control

This feature specifies either variable length decoding or fixed length decoding for this symbology.

**Variable Length:** For variable length decoding, a minimum and maximum length may be set.

**Fixed Length:** For fixed length decoding, two different lengths may be set.



China Sensible Code Length Control = Variable Length



China Sensible Code Length Control = Fixed Length



### China Sensible Code Set Length 1

Specifies one of the barcode lengths for [China Sensible Code Length Control on page 199](#). Length 1 is the minimum label length if in [Variable Length Mode](#), or the first fixed length if in [Fixed Length Mode](#). Characters can be set from 0001 to 7,827 characters in increments of 0001 (pad with zeroes).

See [page 248](#) for detailed instructions on setting this feature.



Select China Sensible Code Length 1 Setting

To configure this feature, scan the ENTER/EXIT PROGRAMMING MODE barcode above, then the barcode at left followed by the digits from the [Alphanumeric characters in Appendix D, Keypad](#) representing your desired character(s). End by scanning the ENTER/EXIT barcode again.

Make a mistake? Scan the CANCEL barcode to abort and not save the entry string. You can then start again at the beginning.



CANCEL

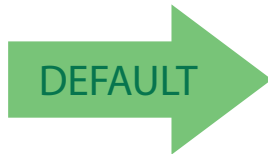

0001 = Length 1 is 1 Character





## China Sensible Code Set Length 2

This feature specifies one of the barcode lengths for [China Sensible Code Length Control on page 199](#). Length 2 is the maximum label length if in Variable Length Mode, or the second fixed length if in Fixed Length Mode. Characters can be set from 0001 to 7,827 characters in increments of 0001 (pad with zeroes).

See [page 249](#) for detailed instructions on setting this feature.



Select China Sensible Code Length 2 Setting

To configure this feature, scan the ENTER/EXIT PROGRAMMING MODE barcode above, then the barcode at left followed by the digits from the Alphanumeric characters in [Appendix D, Keypad](#) representing your desired character(s). End by scanning the ENTER/EXIT barcode again.

Make a mistake? Scan the CANCEL barcode to abort and not save the entry string. You can then start again at the beginning.



CANCEL

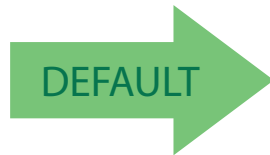

**Length 2 is 7,827 Characters**



## Data Matrix

### Data Matrix Enable / Disable

Enables/disables ability of reader to decode Data Matrix labels.



Data Matrix = Enable



Data Matrix = Disable



### Data Matrix Square/Rectangular Style

Specifies the options available when reading Data Matrix with different form factors. Choices are:

- Square Style
- Rectangular Style
- Both Square and Rectangular Style

The configuration item can also be configured as a bit mask to filter one or more Data Matrix labels with different symbol size AND shape styles.



Data Matrix Dimensions Mask = Square Style



Data Matrix Dimensions Mask = Rectangular Style

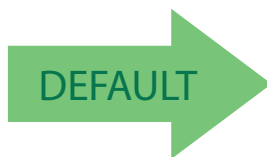

Data Matrix Dimensions Mask = Both Square and Rectangular Style



## Data Matrix Length Control

This feature specifies either variable length decoding or fixed length decoding for this symbology.

**Variable Length:** For variable length decoding, a minimum and maximum length may be set.

**Fixed Length:** For fixed length decoding, two different lengths may be set.

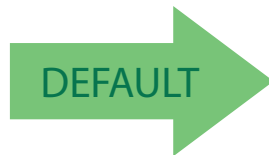

Data Matrix Length Control = Variable Length



Data Matrix Length Control = Fixed Length

## Data Matrix Set Length 1

Specifies one of the barcode lengths for [Data Matrix Length Control on page 203](#). Length 1 is the minimum label length if in [Variable Length Mode](#), or the first fixed length if in [Fixed Length Mode](#). Characters can be set from 0001 to 3,116 characters in increments of 0001 (pad with zeroes).

See [page 248](#) for detailed instructions on setting this feature.



Select Data Matrix Length 1 Setting

To configure this feature, scan the ENTER/EXIT PROGRAMMING MODE barcode above, then the barcode at left followed by the digits from the Alphanumeric characters in [Appendix D, Keypad](#) representing your desired character(s). End by scanning the ENTER/EXIT barcode again.

Make a mistake? Scan the CANCEL barcode to abort and not save the entry string. You can then start again at the beginning.



CANCEL

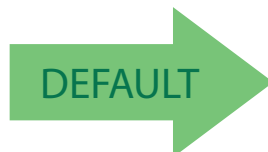

0001 = Length 1 is 1 Character



### Data Matrix Set Length 2

This feature specifies one of the barcode lengths for [Data Matrix Length Control on page 203](#). Length 2 is the maximum label length if in Variable Length Mode, or the second fixed length if in Fixed Length Mode. Characters can be set from 0001 to 3,116 characters in increments of 0001 (pad with zeroes).

See [page 249](#) for detailed instructions on setting this feature.



Select Data Matrix Length 2 Setting

To configure this feature, scan the ENTER/EXIT PROGRAMMING MODE barcode above, then the barcode at left followed by the digits from the Alphanumeric characters in [Appendix D, Keypad](#) representing your desired character(s). End by scanning the ENTER/EXIT barcode again.

Make a mistake? Scan the CANCEL barcode to abort and not save the entry string. You can then start again at the beginning.

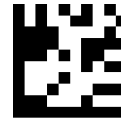

CANCEL

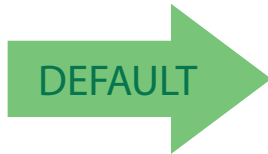

**Length 2 is 3,116 Characters**

## Maxicode

### Maxicode Enable / Disable

Enables/disables ability of reader to decode Maxicode labels.

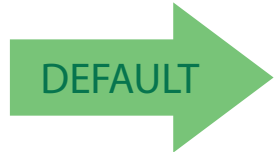

Maxicode = Disable



Maxicode = Enable

### Maxicode Primary Message Transmission

Enables/disables the transmission of only the Primary Message when the Secondary Message is not readable.

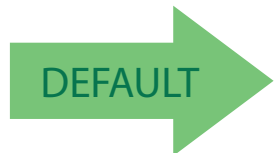

Maxicode Primary Message Transmission = Disable



Maxicode Primary Message Transmission = Enable



## Maxicode Length Control

This feature specifies either variable length decoding or fixed length decoding for this symbology.

**Variable Length:** For variable length decoding, a minimum and maximum length may be set.

**Fixed Length:** For fixed length decoding, two different lengths may be set.

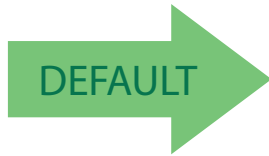

Maxicode Length Control = Variable Length



Maxicode Length Control = Fixed Length

## Maxicode Set Length 1

Specifies one of the barcode lengths for [Maxicode Length Control on page 206](#). Length 1 is the minimum label length if in **Variable Length Mode**, or the first fixed length if in **Fixed Length Mode**. Characters can be set from 0001 to 0145 characters in increments of 0001 (pad with zeroes).

See [page 248](#) for detailed instructions on setting this feature.



Select Maxicode Length 1 Setting

To configure this feature, scan the ENTER/EXIT PROGRAMMING MODE barcode above, then the barcode at left followed by the digits from the Alphanumeric characters in [Appendix D, Keypad](#) representing your desired character(s). End by scanning the ENTER/EXIT barcode again.

Make a mistake? Scan the CANCEL barcode to abort and not save the entry string. You can then start again at the beginning.

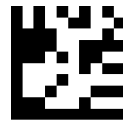

CANCEL



**0001 = Length 1 is 1 Character**



## Maxicode Set Length 2

This feature specifies one of the barcode lengths for [Maxicode Length Control on page 206](#). Length 2 is the maximum label length if in Variable Length Mode, or the second fixed length if in Fixed Length Mode. Characters can be set from 0001 to 0145 characters in increments of 0001 (pad with zeroes).

See [page 249](#) for detailed instructions on setting this feature.



Select Maxicode Length 2 Setting

To configure this feature, scan the ENTER/EXIT PROGRAMMING MODE barcode above, then the barcode at left followed by the digits from the Alphanumeric characters in [Appendix D, Keypad](#) representing your desired character(s). End by scanning the ENTER/EXIT barcode again.

Make a mistake? Scan the CANCEL barcode to abort and not save the entry string. You can then start again at the beginning.



CANCEL

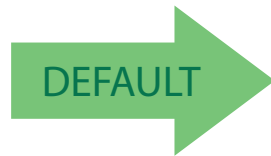

**Length 2 is 0145 Characters**



# PDF417

## PDF417 Enable / Disable

Enables/disables the ability of the reader to decode PDF417 labels.



## PDF417 Length Control

This feature specifies either variable length decoding or fixed length decoding for this symbology.

**Variable Length:** For variable length decoding, a minimum and maximum length may be set.

**Fixed Length:** For fixed length decoding, two different lengths may be set.

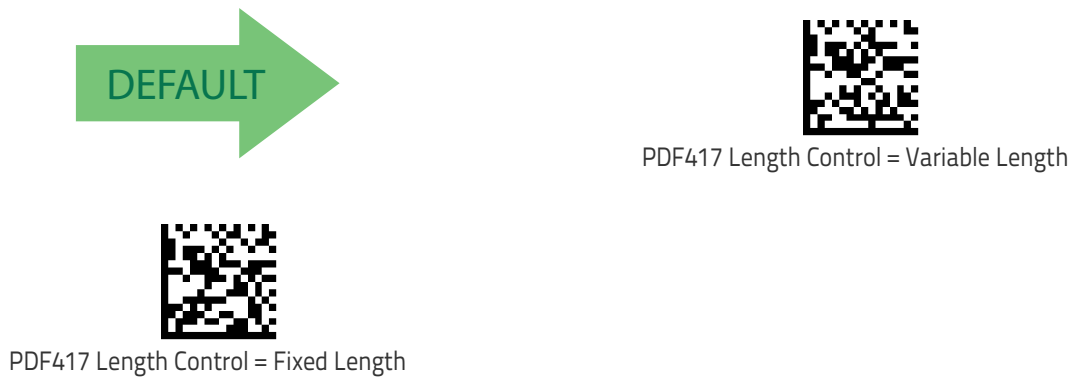





## PDF417 Set Length 1

Specifies one of the barcode lengths for [PDF417 Length Control on page 208](#). Length 1 is the minimum label length if in [Variable Length Mode](#), or the first fixed length if in [Fixed Length Mode](#). Length includes the barcode's data characters only. Characters can be set from 0001 to 2,710 characters (pad with zeroes) in increments of 01. Any value greater than 2,710 will be considered to be 2,710.

See [page 248](#) for detailed instructions on setting this feature.



Select PDF417 Length 1 Setting

To configure this feature, scan the ENTER/EXIT PROGRAMMING MODE barcode above, then the barcode at left followed by the digits from the Alphanumeric characters in [Appendix D, Keypad](#) representing your desired character(s). End by scanning the ENTER/EXIT barcode again.

Make a mistake? Scan the CANCEL barcode to abort and not save the entry string. You can then start again at the beginning.



CANCEL

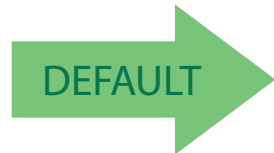

**0001 = Length 1 is 1 Character**



### PDF417 Set Length 2

This feature specifies one of the barcode lengths for [PDF417 Length Control on page 208](#). Length 2 is the maximum label length if in Variable Length Mode, or the second fixed length if in Fixed Length Mode. Length includes the barcode’s check, data, and full-ASCII shift characters. The length does not include start/stop characters. Characters can be set from 01 to 2,710 characters (pad with zeroes) in increments of 01. Any value greater than 2,710 will be considered to be 2,710.

See [page 249](#) for detailed instructions on setting this feature.



Select PDF417 Length 2 Setting

To configure this feature, scan the ENTER/EXIT PROGRAMMING MODE barcode above, then the barcode at left followed by the digits from the Alphanumeric characters in [Appendix D, Keypad](#) representing your desired character(s). End by scanning the ENTER/EXIT barcode again.

Make a mistake? Scan the CANCEL barcode to abort and not save the entry string. You can then start again at the beginning.



CANCEL

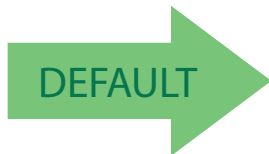

**Length 2 is 2,710 Characters**

## Micro PDF417

### Micro PDF417 Enable / Disable

Enables/disables the ability of the reader to decode Micro PDF417 labels.

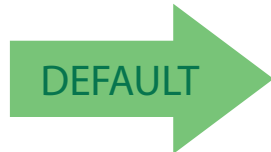

Micro PDF417 = Disable



Micro PDF417 = Enable

### Micro PDF417 Code 128 GS1-128 Emulation

Specifies which AIM ID to use for MicroPDF labels when doing Code 128 or GS1-128 emulation.

Emulation choices are:

- Micro PDF AIM ID and label type
- Code 128 / EAN128 AIM Id and label type

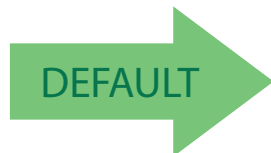

Micro PDF417 Code 128 GS1-128 Emulation =  
Micro PDF AIM ID and label type



Micro PDF417 Code 128 GS1-128 Emulation =  
Code 128 / EAN128 AIM ID and label type



## Micro PDF417 Length Control

This feature specifies either variable length decoding or fixed length decoding for this symbology.

**Variable Length:** For variable length decoding, a minimum and maximum length may be set.

**Fixed Length:** For fixed length decoding, two different lengths may be set.

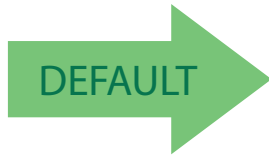

Micro PDF417 Length Control = Variable Length



Micro PDF417 Length Control = Fixed Length

## Micro PDF417 Set Length 1

Specifies one of the barcode lengths for [Micro PDF417 Length Control on page 212](#). Length 1 is the minimum label length if in [Variable Length Mode](#), or the first fixed length if in [Fixed Length Mode](#). Length includes the barcode's data characters only. Characters can be set from 0001 to 0366 characters (pad with zeroes) in increments of 01. Any value greater than 0366 will be considered to be 0366.

See [page 248](#) for detailed instructions on setting this feature.



Select Micro PDF417 Length 1 Setting

To configure this feature, scan the ENTER/EXIT PROGRAMMING MODE barcode above, then the barcode at left followed by the digits from the [Alphanumeric characters in Appendix D, Keypad](#) representing your desired character(s). End by scanning the ENTER/EXIT barcode again.

Make a mistake? Scan the CANCEL barcode to abort and not save the entry string. You can then start again at the beginning.

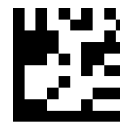

CANCEL

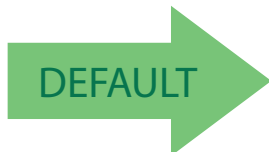

**0001 = Length 1 is 1 Character**



## Micro PDF417 Set Length 2

This feature specifies one of the barcode lengths for [Micro PDF417 Length Control on page 212](#). Length 2 is the maximum label length if in Variable Length Mode, or the second fixed length if in Fixed Length includes the barcode's data characters only. Characters can be set from 0001 to 0366 characters (pad with zeroes) in increments of 01. Any value greater than 0366 will be considered to be 0366.

See [page 249](#) for detailed instructions on setting this feature.



Select Micro PDF417 Length 2 Setting

To configure this feature, scan the ENTER/EXIT PROGRAMMING MODE barcode above, then the barcode at left followed by the digits from the Alphanumeric characters in [Appendix D, Keypad](#) representing your desired character(s). End by scanning the ENTER/EXIT barcode again.

Make a mistake? Scan the CANCEL barcode to abort and not save the entry string. You can then start again at the beginning.



CANCEL

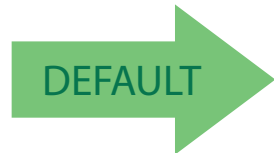

**Length 2 is 0366 Characters**



## QR Code

### QR Code Enable / Disable

Enables/disables the ability of the reader to decode QR Code labels.



### QR Code Length Control

This feature specifies either variable length decoding or fixed length decoding for this symbology.

**Variable Length:** For variable length decoding, a minimum and maximum length may be set.

**Fixed Length:** For fixed length decoding, two different lengths may be set.

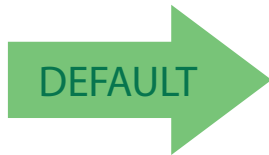



## QR Code Set Length 1

Specifies one of the barcode lengths for [QR Code Length Control on page 214](#). Length 1 is the minimum label length if in [Variable Length Mode](#), or the first fixed length if in [Fixed Length Mode](#). Characters can be set from 0001 to 7,089 characters in increments of 0001 (pad with zeroes).

See [page 248](#) for detailed instructions on setting this feature.



Select QR Code Length 1 Setting

To configure this feature, scan the ENTER/EXIT PROGRAMMING MODE barcode above, then the barcode at left followed by the digits from the Alphanumeric characters in [Appendix D, Keypad](#) representing your desired character(s). End by scanning the ENTER/EXIT barcode again.

Make a mistake? Scan the CANCEL barcode to abort and not save the entry string. You can then start again at the beginning.



CANCEL

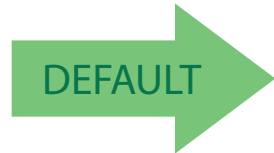

**0001 = Length 1 is 1 Character**



## QR Code Set Length 2

This feature specifies one of the barcode lengths for [QR Code Length Control on page 214](#). Length 2 is the maximum label length if in Variable Length Mode, or the second fixed length if in Fixed Length Mode. Characters can be set from 0001 to 7,089 characters in increments of 0001 (pad with zeroes).

See [page 249](#) for detailed instructions on setting this feature.



Select QR Code Length 2 Setting

To configure this feature, scan the ENTER/EXIT PROGRAMMING MODE barcode above, then the barcode at left followed by the digits from the Alphanumeric characters in [Appendix D, Keypad](#) representing your desired character(s). End by scanning the ENTER/EXIT barcode again.

Make a mistake? Scan the CANCEL barcode to abort and not save the entry string. You can then start again at the beginning.

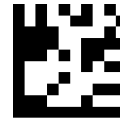

CANCEL

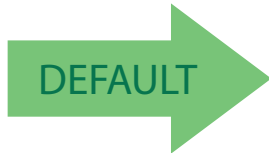

**Length 2 is 7,089 Characters**



## Micro QR Code

### Micro QR Code Enable/Disable

Enables/disables the ability of the reader to decode Micro QR Code labels.

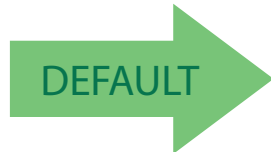

Micro QR Code = Disable



Micro QR Code = Enable

### Micro QR Code Length Control

This feature specifies either variable length decoding or fixed length decoding for this symbology.

**Variable Length:** For variable length decoding, a minimum and maximum length may be set.

**Fixed Length:** For fixed length decoding, two different lengths may be set.



Micro QR Code Length Control = Variable Length



Micro QR Code Length Control = Fixed Length



### Micro QR Code Set Length 1

Specifies one of the barcode lengths for [Micro QR Code Length Control on page 217](#). Length 1 is the minimum label length if in [Variable Length Mode](#), or the first fixed length if in [Fixed Length Mode](#). Characters can be set from 0001 to 0035 characters in increments of 0001 (pad with zeroes).

See [page 248](#) for detailed instructions on setting this feature.



Select Micro QR Code Length 1 Setting

To configure this feature, scan the ENTER/EXIT PROGRAMMING MODE barcode above, then the barcode at left followed by the digits from the [Alphanumeric characters in Appendix D, Keypad](#) representing your desired character(s). End by scanning the ENTER/EXIT barcode again.

Make a mistake? Scan the CANCEL barcode to abort and not save the entry string. You can then start again at the beginning.

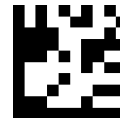

CANCEL

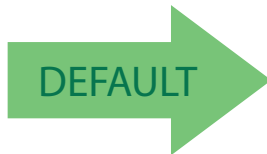

**0001 = Length 1 is 1 Character**



## Micro QR Code Set Length 2

This feature specifies one of the barcode lengths for [Micro QR Code Length Control on page 217](#). Length 2 is the maximum label length if in Variable Length Mode, or the second fixed length if in Fixed Length Mode. Characters can be set from 0001 to 0035 characters in increments of 0001 (pad with zeroes).

See [page 249](#) for detailed instructions on setting this feature.



Select QR Code Length 2 Setting

To configure this feature, scan the ENTER/EXIT PROGRAMMING MODE barcode above, then the barcode at left followed by the digits from the Alphanumeric characters in [Appendix D, Keypad](#) representing your desired character(s). End by scanning the ENTER/EXIT barcode again.

Make a mistake? Scan the CANCEL barcode to abort and not save the entry string. You can then start again at the beginning.



CANCEL

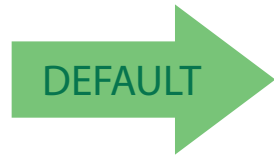

**Length 2 is 0035 Characters**



## UCC Composite

### UCC Composite Enable / Disable

Enables/disables the ability of the reader to decode the stacked part of a UCC Composite label.



NOTE

This feature is not effective when Global AIM IDs are enabled (see "Global AIM ID" on page 55).

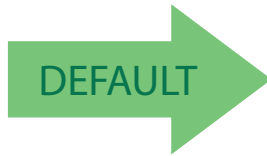

UCC Composite = Disable



UCC Composite = Enable



## UCC Optional Composite Timer

Specifies the amount of time the system will wait for the stacked part of a UCC Composite label before transmitting the linear label without an add-on.

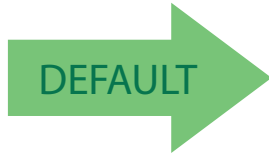

UCC Optional Composite Timer = Timer Disabled



UCC Optional Composite Timer = 100msec



UCC Optional Composite Timer = 200msec



UCC Optional Composite Timer = 300msec



UCC Optional Composite Timer = 400msec



UCC Optional Composite Timer = 500msec



## Postal Code Selection

Enables/disables the ability of the scanner to decode labels of a specific postal symbology.

- Disable All Postal Codes
- Postnet
- Planet
- Royal Mail
- Kix
- Australia Post
- Japan Post
- IMB
- Sweden Post
- Portugal Post

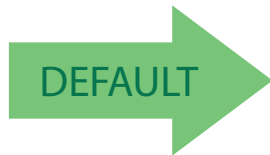

Postal Code Selection = Disable All Postal Codes



Postal Code Selection = Enable Postnet



Postal Code Selection = Enable Planet



Postal Code Selection = Enable Royal Mail



Postal Code Selection = Enable Kix



Postal Code Selection = Enable Australia Post

## Postal Code Selection (continued)



Postal Code Selection = Enable Japan Post



Postal Code Selection = Enable IMB



Postal Code Selection = Enable Sweden Post



Postal Code Selection = Enable Portugal Post

## Postnet BB Control

Controls the ability of the scanner to decode B and B' fields of Postnet labels.

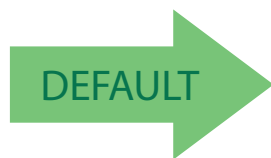

Postnet BB Control = Disable



Postnet BB Control = Enable

# NOTES





## Chapter 4 References

This section contains explanations and examples of selected barcode features. See "Configuration Using barcodes" starting on page 21 for the actual barcode labels used to configure the scanner.

<b>SERIAL PARAMETERS</b> on page 225 <ul style="list-style-type: none"><li>▪ USB COM Parameters on page 225</li></ul>
<b>KEYBOARD INTERFACE</b> on page 233 <ul style="list-style-type: none"><li>▪ Intercharacter Delay on page 233</li><li>▪ Intercode Delay on page 234</li></ul>
<b>DATA FORMAT</b> on page 235 <ul style="list-style-type: none"><li>▪ Data Editing on page 235</li><li>▪ Global Prefix/Suffix on page 236</li><li>▪ Global AIM ID on page 237</li><li>▪ Label ID on page 238</li><li>▪ Character Conversion on page 242</li></ul>
<b>READING PARAMETERS</b> on page 243 <ul style="list-style-type: none"><li>▪ RGB LED Features on page 243</li></ul>
<b>SCANNING FEATURES</b> on page 246 <ul style="list-style-type: none"><li>▪ Scan Mode on page 246</li><li>▪ Scanning Active Time on page 246</li><li>▪ Symbologies on page 248</li></ul>
<b>SYMBOLOGIES</b> on page 248 <ul style="list-style-type: none"><li>▪ Set Length on page 248</li><li>▪ Set Length on page 248</li></ul>

### Serial Parameters

#### USB COM Parameters

##### Intercharacter Delay

This parameter specifies the intercharacter delay between the end of one character and the beginning of the next. The delay can be set within a range of zero

(0) to 990 milliseconds in 10ms increments. A setting of zero specifies no delay.

To set the delay:

1. Determine the desired setting in milliseconds.
2. Divide the desired setting by 10 (setting is in 10ms increments). Pad the result with leading zeroes to yield two digits. For example: 0 = 00, 5 = 05, 20 = 20, etc.
3. Scan the ENTER/EXIT PROGRAMMING MODE barcode to enter Programming Mode.
4. Go to [page 26](#) and scan the barcode: SELECT INTERCHARACTER DELAY SETTING.
5. Scan the appropriate two digits from the keypad in [Appendix D, Keypad](#), that represent the duration which was determined in the steps above. You will hear a two-beep indication after the last character.



#### NOTE

If you make a mistake before the last character, scan the CANCEL barcode to abort and not save the entry string. You can then start again at the beginning.

6. Scan the ENTER/EXIT PROGRAMMING MODE barcode to exit.

This completes the procedure. See the following table for examples of how to set this feature.

**Table 2. Intercharacter Delay Setting Examples**

STEP	ACTION	EXAMPLES			
1	Desired Setting	50ms	150ms	600ms	850ms
2	Divide by 10 (pad with leading zeroes to yield two-digits)	05	15	60	85
3	Scan ENTER/EXIT PROGRAMMING MODE				
4	Scan SELECT INTERCHARACTER DELAY SETTING				
5	Scan Two Characters From Appendix D, Keypad	'0' and '5'	'1' and '5'	'6' and '0'	'8' and '5'
6	Scan ENTER/EXIT PROGRAMMING MODE				

### ACK NAK Options

This enables/disables the ability of the scanner to support the RS-232 ACK/NAK protocol. When configured, the scanner and/or host sends an "ACK" when it receives data properly, and sends "NAK" when the data is in error.

Options are:

- Disable

- Enable for label transmission — The scanner expects an ACK/NAK response from the host when a label is sent
- Enable for host–command acknowledge — The scanner will respond with ACK/NAK when the host sends a command
- Enable for label transmission and host–command acknowledge

## ACK Character

This setting specifies an ASCII character or hex value to be used as the ACK character. ASCII characters or any hex value from 0 to 0xFF can be selected.



Setting to previously defined characters such as XON, XOFF, or host commands conflicts with normal operation of these characters.

### NOTE

1. Determine the desired character or value.
  2. Use the [ASCII Chart on page 303](#) on the inside back cover of this manual to find the hex equivalent for the desired character/value.
  3. Go to [page 29](#) and scan ENTER/EXIT PROGRAMMING MODE to enter Programming Mode.
  4. Scan the barcode: SELECT ACK CHARACTER SETTING.
  5. Scan the appropriate two alphanumeric characters from the keypad in [Appendix D, Keypad](#), that represent the desired character/value determined above. The second character will cause a two-beep indication.
  6. Scan the ENTER/EXIT PROGRAMMING MODE barcode to exit.
- See the table below for examples of how to set this feature.

**Table 3. ACK Character Setting Examples**

STEP	ACTION	EXAMPLES			
1	Desired Character/Value	ACK	\$	@	>
2	Hex equivalent from ASCII Chart on page 303	0x06	0x24	0x40	0x3E
3	Scan ENTER/EXIT PROGRAMMING MODE				
4	Scan SELECT ACK CHARACTER SETTING				
5	Scan Two Characters from Appendix D, Keypad	'0' and '6'	'2' and '4'	'4' and '0'	'3' AND 'E'
6	Scan ENTER/EXIT PROGRAMMING MODE				

## NAK Character

This setting specifies an ASCII character or hex value to be used as the NAK character. ASCII characters or any hex value from 0 to 0xFF can be selected.

**NOTE**

Setting to previously defined characters such as XON, XOFF, or host commands conflicts with normal operation of these characters.

To set this feature:

1. Determine the desired character or value.
2. Use the [ASCII Chart on page 303](#) on the inside back cover of this manual to find the hex equivalent for the desired character/value.
3. Scan the ENTER/EXIT PROGRAMMING MODE barcode to enter Programming Mode.
4. Scan the barcode: SELECT NAK CHARACTER SETTING.
5. Scan the appropriate two alpha-numeric characters from the keypad in [Appendix D, Keypad](#), that represent the desired character/value determined above. The second character will cause a two-beep indication.
6. Scan the ENTER/EXIT PROGRAMMING MODE barcode to exit Programming Mode.

This completes the procedure. See the table below for examples of how to set this feature.

**Table 4. NAK Character Setting Examples**

STEP	ACTION	EXAMPLES			
1	Desired Character/Value	NAK	\$	@	>
2	Hex equivalent	0x15	0x24	0x40	0x3E
3	Scan ENTER/EXIT PROGRAMMING MODE				
4	Scan SELECT NAK CHARACTER SETTING				
5	Scan Two Characters From Appendix D, Keypad	'1' and '5'	'2' and '4'	'4' and '0'	'3' AND 'E'
6	Scan ENTER/EXIT PROGRAMMING MODE				

## ACK NAK Timeout Value

This option specifies the amount of time the scanner waits for an ACK character from the host following label transmission. The selectable timeout range is 200 milliseconds to 15,000ms (15 seconds) in 200ms increments. A selection of 0 disables the timeout.

To set this value:

1. Determine the desired setting in milliseconds.
2. Divide the desired setting by 200 (setting is in 200ms increments). Pad the result with leading zeroes to yield two digits. For example: 0 = 00, 5 = 05, 20 = 20, etc.
3. Go to [page 30](#) and scan the ENTER/EXIT PROGRAMMING MODE barcode to enter Programming Mode.
4. Scan the barcode: SELECT ACK NAK TIMEOUT VALUE SETTING.
5. Scan the appropriate two digits from the keypad in [Appendix D, Keypad](#), that represent the duration which was determined in the steps above. You will hear a two-beep indication after the last character.



### NOTE

If you make a mistake before the last character, scan the CANCEL barcode to abort and not save the entry string. You can then start again at the beginning.

6. Scan the ENTER/EXIT PROGRAMMING MODE barcode to exit Programming Mode.

This completes the procedure. See the table below for examples of how to set this feature.

**Table 5. ACK NAK Timeout Value Setting Examples**

STEP	ACTION	EXAMPLES			
1	Desired Setting	200ms	1,000ms (1 sec.)	5200ms (5.2 sec.)	15,000ms (15 sec.)
2	Divide by 200	01	05	26	75
3	Scan ENTER/EXIT PROGRAMMING MODE				
4	Scan SELECT ACK NAK TIMEOUT VALUE SETTING				
5	Scan Two Characters From Appendix D, Keypad	'0' and '1'	'0' and '5'	'2' and '6'	'7' and '5'
6	Scan ENTER/EXIT PROGRAMMING MODE				

## ACK NAK Retry Count

This feature specifies the number of times the scanner retries a label transmission due to a retry condition. The selectable range is from 1 to 254 retries. A selection of 0 disables the count, and a selection of 255 specifies unlimited retries.

To set this feature:

1. Determine the desired setting.
2. Pad the number with leading zeroes to yield three digits. For example: 0 = 000, 5 = 005, 20 = 020, etc.
3. Go to [page 31](#) and scan the ENTER/EXIT PROGRAMMING MODE barcode to enter Programming Mode.
4. Scan the barcode: SELECT ACK NAK RETRY COUNT SETTING.
5. Scan the appropriate three digits from the keypad in [Appendix D, Keypad](#), that represent the number which was determined in the steps above. You will hear a two-beep indication after the last character.



### NOTE

If you make a mistake before the last character, scan the CANCEL barcode to abort and not save the entry string. You can then start again at the beginning.

6. Scan the ENTER/EXIT PROGRAMMING MODE barcode to exit Programming Mode.

This completes the procedure. See the table below for examples of how to set this feature.

**Table 6. ACK NAK Retry Count Setting Examples**

STEP	ACTION	EXAMPLES			
1	Desired Setting	Disable Retry Count	3 Retries	54 Retries	Unlimited Retries
2	Pad with leading zero(es)	000	003	054	255
3	Scan ENTER/EXIT PROGRAMMING MODE				
4	Scan SELECT ACK NAK RETRY COUNT SETTING				
5	Scan Three Characters From Appendix D, Keypad	'0', '0' and '0'	'0', '0' and '3'	'0', '5' and '4'	'2', '5' and '5'
6	Scan ENTER/EXIT PROGRAMMING MODE				

## Disable Character

Specifies the value of the RS-232 host command used to disable the scanner. ASCII characters or any hex value from 0 to 0xFF can be selected.



Setting to previously defined characters such as XON, XOFF, or host commands conflicts with normal operation of these characters.

### NOTE

To set the value:

1. Determine the desired character or value. A setting of 0xFF indicates the Disable Character is not used (not available).
2. Use the [ASCII Chart on page 303](#) on the inside back cover of this manual to find the hex equivalent for the desired character/value.
3. Go to [page 33](#) and scan the ENTER/EXIT PROGRAMMING MODE barcode to enter Programming Mode.
4. Scan the barcode: SELECT DISABLE CHARACTER SETTING on [page 33](#).
5. Scan the appropriate two alphanumeric characters from the keypad in [Appendix D, Keypad](#), that represent the desired character/value determined above. The second character will cause a two-beep indication.
6. Scan the ENTER/EXIT PROGRAMMING MODE barcode to exit Programming Mode.

This completes the procedure. See the table below for examples of how to set this feature.

**Table 7. Disable Character Setting Examples**

STEP	ACTION	EXAMPLES			
1	Desired character/value	'd'	'}'	'D'	Disable Command Not Used
2	Hex equivalent from ASCII Chart on page 303	0x64	0x7D	0x44	0xFF
3	Scan ENTER/EXIT PROGRAMMING MODE				
4	Scan SELECT DISABLE CHARACTER VALUE SETTING				
5	Scan Two Characters From Appendix D, Keypad	'6' and '4'	'7' and 'D'	'4' and '4'	'F' and 'F'
6	Scan ENTER/EXIT PROGRAMMING MODE				

## Enable Character

Specifies the value of the RS-232 host command used to enable the scanner. ASCII characters or any hex value from 0 to 0xFF can be selected.



Setting to previously defined characters such as XON, XOFF, or host commands conflicts with normal operation of these characters.

### NOTE

To set this feature:

Determine the desired character or value. A setting of 0xFF indicates the Enable Character is not used (not available).

1. Determine the desired character or value.
2. Use the [ASCII Chart on page 303](#) on the inside back cover of this manual to find the hex equivalent for the desired character/value.
3. Go to [page 34](#) and scan the ENTER/EXIT PROGRAMMING MODE barcode to enter Programming Mode.
4. Scan the barcode: SELECT ENABLE CHARACTER SETTING on [page 34](#).
5. Scan the appropriate two alphanumeric characters from the keypad in [Appendix D, Keypad](#), that represent the desired character/value determined above. The second character will cause a two-beep indication.
6. Scan the ENTER/EXIT PROGRAMMING MODE barcode to exit Programming Mode.

This completes the procedure. See the table below for examples of how to set this feature.

**Table 8. Enable Character Setting Examples**

STEP	ACTION	EXAMPLES			
1	Desired character/value	'e'	'j'	'E'	Enable Command Not Used
2	Hex equivalent from ASCII Chart on page 303	0x65	0x7D	0x45	0xFF
3	Scan ENTER/EXIT PROGRAMMING MODE				
4	Scan SELECT ENABLE CHARACTER SETTING				
5	Scan Two Characters From Appendix D, Keypad	'6' and '5'	'7' and 'D'	'4' and '5'	'F' and 'F'
6	Scan ENTER/EXIT PROGRAMMING MODE				



# Keyboard Interface

## Intercharacter Delay

This parameter specifies the intercharacter delay between the end of one character and the beginning of the next. The delay can be set within a range of zero (0) to 990 milliseconds in 10ms increments. A setting of zero specifies no delay.



This feature applies **ONLY** to the Keyboard Wedge interface.

### NOTE

To set the delay:

1. Determine the desired setting in milliseconds.
2. Divide the desired setting by 10 (setting is in 10ms increments). Pad the result with leading zeroes to yield two digits. For example: 0 = 00, 5 = 05, 20 = 20, etc.
3. Go to [page 61](#) and scan the ENTER/EXIT PROGRAMMING MODE barcode to enter Programming Mode.
4. Scan the barcode: SELECT INTERCHARACTER DELAY SETTING on [page 61](#).
5. Scan the appropriate two digits from the keypad in [Appendix D, Keypad](#), that represent the duration which was determined in the steps above. You will hear a two-beep indication after the last character.



If you make a mistake before the last character, scan the CANCEL barcode to abort and not save the entry string. You can then start again at the beginning.

### NOTE

6. Scan the ENTER/EXIT PROGRAMMING MODE barcode to exit Programming Mode.

This completes the procedure. See the table below for examples of how to set this feature.

**Table 9. Intercharacter Delay Setting Examples**

STEP	ACTION	EXAMPLES			
1	Desired Setting	50ms	150ms	600ms	850ms
2	Divide by 10 (and pad with leading zeroes to yield two-digits)	05	15	60	85
3	Scan ENTER/EXIT PROGRAMMING MODE				
4	Scan SELECT INTERCHARACTER DELAY SETTING				

STEP	ACTION	EXAMPLES			
1	Desired Setting	50ms	150ms	600ms	850ms
5	Scan Two Characters From Appendix D, Keypad	'0' and '5'	'1' and '5'	'6' and '0'	'8' and '5'
6	Scan ENTER/EXIT PROGRAMMING MODE				

## Intercode Delay

Specifies the delay between labels transmitted to the host for this interface. The selectable range for this feature is from 0 to 99 seconds.

Follow these instructions to set this feature:

1. Determine the desired setting.
2. Pad the number with leading zeroes to yield two digits. For example: 0 = 00, 5 = 05, 20 = 20, etc
3. Go to [page 62](#) and scan the ENTER/EXIT PROGRAMMING MODE barcode to enter Programming Mode.
4. Scan the barcode: SELECT INTERCODE DELAY SETTING on [page 62](#).
5. Scan the appropriate two digits from the keypad in [Appendix D, Keypad](#), that represent the duration which was determined in the steps above. You will hear a two-beep indication after the last character.



### NOTE

If you make a mistake before the last character, scan the CANCEL barcode to abort and not save the entry string. You can then start again at the beginning.

6. Scan the ENTER/EXIT PROGRAMMING MODE barcode to exit Programming Mode.

This completes the procedure. See the table below for examples of how to set this feature.

**Table 10. Wedge Intercode Delay Examples**

STEP	ACTION	EXAMPLES			
1	Desired Setting	No Delay	5 Seconds	60 Seconds	99 Seconds
2	Pad with leading zero(es)	00	05	60	99
3	Scan ENTER/EXIT PROGRAMMING MODE				
4	Scan SELECT INTERCODE DELAY SETTING				
5	Scan Two Characters From Appendix D, Keypad	'0' and '0'	'0' and '5'	'6' and '0'	'9' and '9'
6	Scan ENTER/EXIT PROGRAMMING MODE				

# Data Format

## Data Editing

When a barcode is scanned, additional information can be sent to the host computer along with the barcode data. This combination of barcode data and supplementary user-defined data is called a “message string.” The Data Editing features can be used to build specific user-defined data into a message string. There are several types of selectable data characters that can be sent before and after scanned data. You can specify if they should be sent with all symbologies, or only with specific symbologies. The following shows the available elements you can add to a message string:

**Figure 1. Breakdown of a Message String**

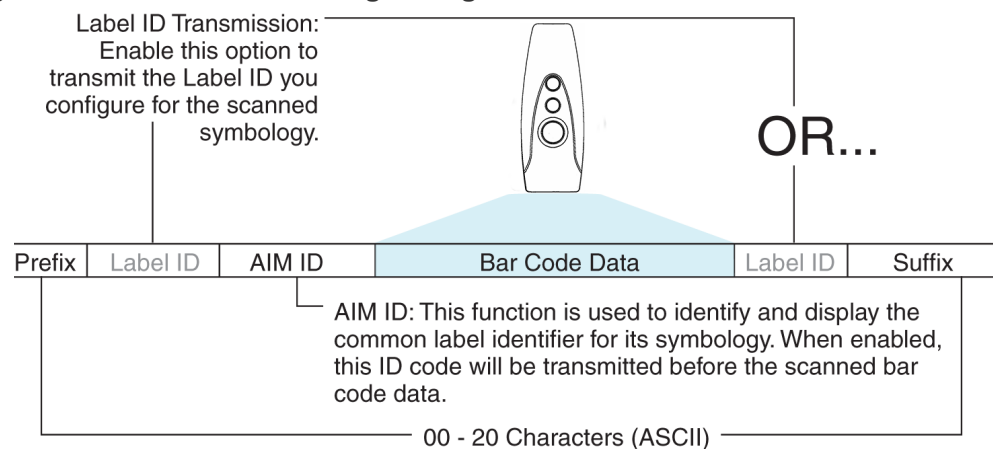

Additional advanced editing is available. See the [Advanced formatting features in the Datalogic Aladdin configuration software](#), or contact [Technical Support \(see page 4\)](#) for more information.

### Please Keep In Mind...

- Modifying a message string is not a mandatory requirement. Data editing is a sophisticated feature allowing highly customizable output for advanced users. Factory default settings for data editing is typically set to NONE.
- A prefix or suffix may be applied only to a specified symbology (reference [1D Symbologies, starting on page 105](#)) or across all symbologies (set via the Global features in [Configuration Using barcodes, starting on page 21](#)).
- You can add any character from the [ASCII Chart on page 303](#) (from 00–FF) on the inside back cover of this manual as a prefix, suffix or Label ID.
- Enter prefixes and suffixes in the order in which you want them to appear on the output.

## Global Prefix/Suffix

Up to 20 ASCII characters may be added as a prefix (in a position before the barcode data) and/or as a suffix (in a position following the barcode data) as indicated.

Figure 2. Prefix and Suffix Positions

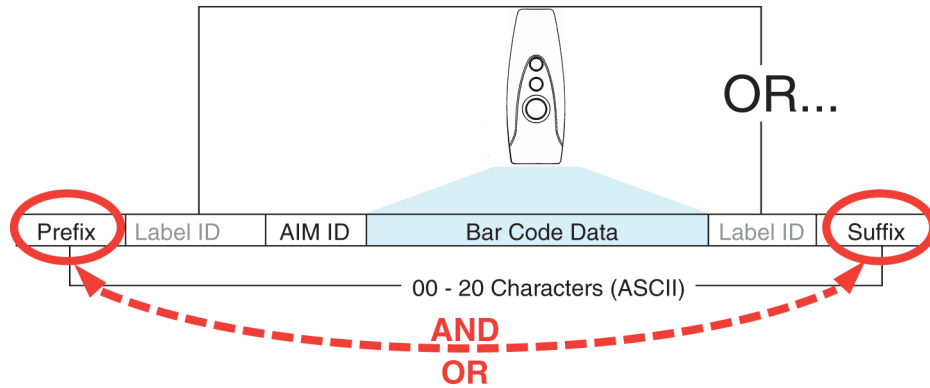

### Example: Setting a Prefix

In this example, we'll set a prefix for all symbologies.

1. Determine which ASCII character(s) are to be added to scanned barcode data. In this example, we'll add a dollar sign ('\$') as a prefix.
2. Go to [page 68](#) and scan the ENTER/EXIT PROGRAMMING MODE barcode, then scan the SET GLOBAL PREFIX barcode.
3. Reference the [ASCII Chart on page 303](#) on the inside back cover of this manual to find the hex value assigned to the desired character. The corresponding hex number for the '\$' character is 24. To enter this selection code, scan the '2' and '4' barcodes from [Appendix D, Keypad](#).



#### NOTE

If you make a mistake before the last character, scan the CANCEL barcode to abort and not save the entry string. You can then start again at the beginning.

4. If less than the expected string of 20 characters are selected, scan the ENTER/EXIT barcode to terminate the string.
5. Scan the ENTER/EXIT barcode once again to exit Programming Mode.
6. The resulting message string would appear as follows:  
Scanned barcode data: 12345  
Resulting message string output: \$12345

## Global AIM ID



This feature enables/disables addition of AIM IDs for all symbology types.

### NOTE

AIM label identifiers (as opposed to custom characters you select yourself as with label identifiers) can be included with scanned barcode data. AIM label identifiers consist of three characters as follows:

- A close brace character (ASCII ‘}’), followed by...
- A code character (see the table below), followed by...
- A modifier character (the modifier character is symbol dependent).

SYMBOLGY	CHAR	SYMBOLGY	CHAR
UPC/EAN	E <sup>a</sup>	Code 128/GS1-128	C
Code 39 and Code 32	A	DataBar Omnidirectional, DataBar Expanded	e
Codabar	F	Standard 2 of 5	S
Interleaved 2 of 5	I	ISBN	X <sup>b</sup>
Code 93	G	Code 11	H

- UPC-A and UPC-E labels are converted to EAN 13 when adding AIM IDs.
- ISBN (X with a 0 modifier character)

Figure 3. AIM ID

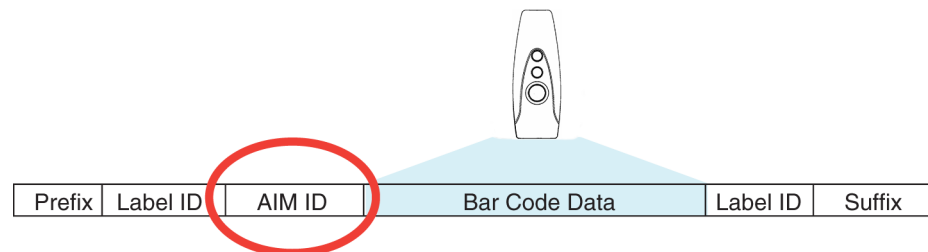

## Label ID

A Label ID is a customizable code of up to three ASCII characters (each can be one of hex 0x01–0xFF), used to identify a barcode (symbology) type. It can be appended previous to or following the transmitted barcode data depending upon how this option is enabled. This feature provides options for configuring custom Label IDs as a pre-loaded set or individually per symbology (see "Label ID: Set Individually Per Symbology" on page 71). If you wish to program the scanner to always include an industry standard label identifier for ALL symbology types, see "Global AIM ID" on page 69.

### Label ID: Pre-loaded Sets

The following table lists the pre-loaded label ID sets for the USA and Europe.

**Table 11. Label ID Pre-loaded Sets**

Symbology	USA Label ID set		EU Label ID set	
	ASCII character	Hex value	ASCII character	Hexadecimal value
ABC Codabar	S	530000	S	530000
CODABAR	%	250000	R	520000
Code 39 CIP	Y	590000	Y	590000
Code 93	&	260000	U	550000
CODE11	CE	434500	b	620000
CODE128	#	230000	T	540000
CODE32	A	410000	X	580000
CODE39	*	2A0000	V	560000
CODE4	4	340000	4	340000
CODE5	j	6A0000	j	6A0000
CODE93	&	260000	U	550000
DATALOGIC 20F5	s	730000	s	730000
EAN13	F	460000	B	420000
EAN13 P2	F	460000	L	4C0000
EAN13 P5	F	460000	M	4D0000
EAN8	FF	464600	A	410000
EAN8 P2	FF	464600	J	4A0000
EAN8 P5	FF	464600	K	4B0000
FOLLETT 20F5	O	4F0000	O	4F0000
GS1 DATABAR EXPANDED	RX	525800	t	740000
GS1 DATABAR LIMITED	RL	524C00	v	760000

Symbology	USA Label ID set		EU Label ID set	
GS1 DATABAR OMNIDIRECTIONAL	R4	523400	u	750000
GS1-128		000000	k	6B0000
I2OF5	i	690000	N	4E0000
IATA	IA	494100	&	260000
Industrial 2 of 5	W	570000	W	570000
Interleaved 2 of 5 CIP HR	e	650000	e	650000
ISBN	l	490000	@	400000
ISBT128	f	660000	f	660000
ISSN	n	6E0000	n	6E0000
MSI	@	400000	Z	5A0000
S25	s	730000	P	500000
UPCA	A	410000	C	430000
UPCA P2	A	410000	F	460000
UPCA P5	A	410000	G	470000
UPCE	E	450000	D	440000
UPCE P2	E	450000	H	480000
UPCE P5	E	450000	I	490000

## Label ID: Set Individually Per Symbology

To configure a Label ID individually for a single symbology:

1. Scan the ENTER/EXIT barcode.
2. Select Label ID position as either BEFORE (Enable as Prefix) or AFTER (Enable as suffix) by scanning the appropriate barcode in the section "Label ID Control" on page 71. Reference Figure 4 for Label ID positioning options if multiple identification features are enabled.
3. Scan a barcode to select the symbology for which you wish to configure a custom Label ID from the section [Case Conversion, starting on page 78](#).
4. Determine the desired character(s) (you may choose up to three) which will represent the Label ID for the selected symbology.
5. Turn to the [ASCII Chart on page 303](#) on the inside back cover of this manual and find the equivalent hex digits associated with your choice of Label ID. For example, if you wish to select an equal sign (=) as a Label ID, the chart indicates its associated hex characters as 3D. Turn to [Keypad, starting on page 295](#) and scan the barcodes representing the hex characters determined. For the example given, the characters '3' and 'D' would be scanned. More examples of Label ID settings are provided in [Table 12](#).



### NOTE

If you make a mistake before the last character, scan the CANCEL barcode to abort and not save the entry string. You can then start again at the beginning.

6. Scan the ENTER/EXIT barcode to exit Label ID entry.
7. Scan the ENTER/EXIT barcode once again to exit Programming Mode.

This completes the steps to configure a Label ID for a given symbology.

**Figure 4. Label ID Position Options**

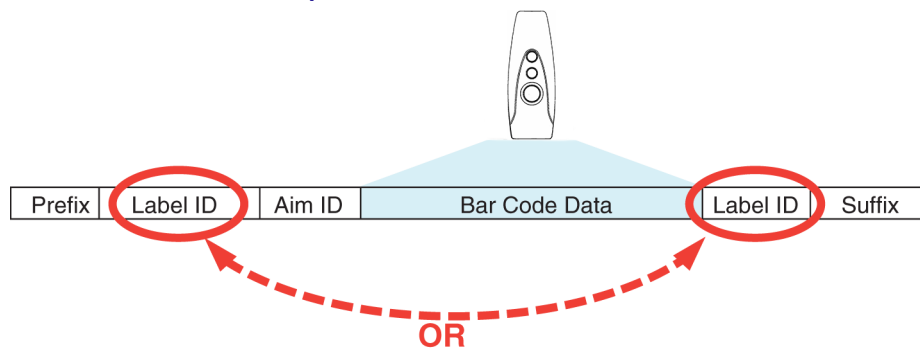



## Label ID: Set Individually Per Symbology — continued

Table 12. Label ID Examples

STEP	ACTION	EXAMPLES			
1.	Scan the ENTER/EXIT barcode	(Scanner enters Programming Mode)			
2.	Determine placement of the Label ID characters BEFORE or AFTER with regard to scanned data using "Label ID Control" on page 71	Enable as Prefix	Enable as Suffix	Enable as Prefix	Enable as Suffix
3.	Scan the barcode selecting the symbology type you wish to designate label ID characters for using Case Conversion, starting on page 78.	GS1 DataBar Omnidirectional	Code 39	Interleaved 2 of 5	Code 32
4.	Custom Label ID example (desired characters):	D B *	= C 3	+	P H
5.	Find hex equivalents from the ASCII table (inside back cover), then scan in these digits/characters using the barcodes in the section: Keypad, starting on page 295. If you make a mistake before the last character, scan the CANCEL barcode to abort and not save the entry string. You can then start again at the beginning.	44 42 2A	3D 43 33	2B	50 48
6.	Scan the ENTER/EXIT barcode	(Scanner exits Label ID entry)			
7.	Scan the ENTER/EXIT barcode once again	(Scanner exits Programming Mode)			
<b>Result:</b>		DB*[barcode data]	[barcode data]=C3	+ [barcode data]	[barcode data]PH

---

## Character Conversion

Character conversion is an eight byte configuration item. The eight bytes are 4 character pairs represented in hexadecimal ASCII values. The first character in the pair is the character that will be converted. The second character in the pair is the character to convert to. If the character to convert in a pair is FF, then no conversion is done.

For example, if you have the character conversion configuration item set to the following: 41423132FFFFFFF

The first pair is 4142 or AB (41 hex is an ASCII capital A, 42 hex is an ASCII capital B) and the second pair is 3132 or 12 (31 hex is an ASCII 1, 32 is an ASCII 2). The other two pairs are FFFF and FFFF.

With the label, AB12BA21, it would look as follows after the character conversion: BB22BB22.

The A characters were converted to B characters and the 1 characters were converted to 2 characters. Nothing is done with the last two character pairs, since they are all FF.

To set Character Conversion:

1. Scan the ENTER/EXIT barcode.
2. Scan the barcode for "Character Conversion" on page 78
3. Determine the desired string. Sixteen positions must be determined as in the above example. Next, turn to the [ASCII Chart on page 303](#) on the inside back cover of this manual and find the equivalent hex digits needed to fulfill the string.
4. Turn to [Appendix D, Keypad](#) and scan the barcodes representing the hex characters determined in the previous step.
5. Scan the ENTER/EXIT barcode to exit Programming Mode.



### NOTE

If less than the expected string of 16 characters are selected, scan the ENTER/EXIT barcode twice to accept the selections and exit Programming Mode.

# Reading Parameters

## RGB LED Features

### RGB Good Read Raising/Falling Time

This parameter specifies the time it will take for the RGB good read to change the status from an Off state to Brightness state, or back.

The delay can be set within a range of zero (0) to 160000 milliseconds (16 seconds) in 100ms increments. A setting of zero specifies no delay.

To set the time:

1. Determine the desired setting in milliseconds.
2. Divide the desired setting by 100 (setting is in 100ms increments). Pad the result with leading zeroes to yield two digits. For example: 0 = 00, 5 = 05, 20 = 20, etc.
3. Scan the ENTER/EXIT PROGRAMMING MODE barcode to enter Programming Mode.
4. Scan the barcode: SELECT RGB GOOD READ RAISING TIME on [page 97](#) or RBG GOOD READ FALLING TIME on [page 99](#).
5. Scan the appropriate two digits from the keypad in [Appendix D, Keypad](#), that represent the duration which was determined in the steps above.



**NOTE**

If you make a mistake before the last character, scan the CANCEL barcode to abort and not save the entry string. You can then start again at the beginning.

6. Scan the ENTER/EXIT PROGRAMMING MODE barcode to exit.

This completes the procedure. See the following table for examples of how to set this feature.

**Table 13. RGB Good Read Raising/Falling Time Examples**

STEP	ACTION	EXAMPLES			
1	<b>Desired Setting</b>	100ms	200ms	1000ms (1 sec.)	5000ms (5 secs.)
2	<b>Divide by 100</b>	01	02	10	50
3	<b>Scan ENTER/EXIT PROGRAMMING MODE</b>				
4	<b>Scan SELECT RGB GOOD READ RAISING/FALLING TIME</b>				
5	<b>Scan Two Characters From Appendix D, Keypad</b>	'0' and '1'	'0' and '2'	'1' and '0'	'5' and '0'
6	<b>Scan ENTER/EXIT PROGRAMMING MODE</b>				

## RGB Good Read Holding Time

This parameter specifies the time it will take for the RGB good read to change the status from an Off state to Brightness state.

The delay can be set within a range of zero (0) to 255 milliseconds (25.5 seconds) in 100ms increments. A setting of zero specifies no delay.

To set the time:

1. Determine the desired setting in milliseconds.
2. Divide the desired setting by 100 (setting is in 100ms increments). Pad the result with leading zeroes to yield two digits. For example: 0 = 00, 5 = 05, 20 = 20, etc.
3. Scan the ENTER/EXIT PROGRAMMING MODE barcode to enter Programming Mode.
4. Go to [page 100](#) and scan the barcode: SELECT RGB GOOD READ HOLDING TIME.
5. Scan the appropriate two digits from the keypad in [Appendix D, Keypad](#), that represent the duration which was determined in the steps above.



**NOTE**

If you make a mistake before the last character, scan the CANCEL barcode to abort and not save the entry string. You can then start again at the beginning.

6. Scan the ENTER/EXIT PROGRAMMING MODE barcode to exit.

This completes the procedure. See the following table for examples of how to set this feature.

**Table 14. RGB Good Read Holding Time Examples**

STEP	ACTION	EXAMPLES			
1	Desired Setting	100ms	200ms	1,000ms (1 sec.)	5,000ms (5 secs.)
2	Divide by 100	01	02	10	50
3	Scan ENTER/EXIT PROGRAMMING MODE				
4	Scan SELECT RGB GOOD READ HOLDING TIME				
5	Scan Two Characters From Appendix D, Keypad	'0' and '1'	'0' and '2'	'1' and '0'	'5' and '0'
6	Scan ENTER/EXIT PROGRAMMING MODE				

## RGB Auto Delay Time

Specifies the delay time for running the RGB auto mode after the scanner has gone into an idle state (no label reading, label programming or communication with Host).

The delay can be set within a range of zero (0) to 255 milliseconds (5 seconds) in 500ms increments. The value 0x00 means Auto Mode is disabled.

To set the time:

1. Determine the desired setting in milliseconds.
2. Divide the desired setting by 500 (setting is in 500ms increments). Pad the result with leading zeroes to yield two digits. For example: 0 = 00, 5 = 05, 20 = 20, etc.
3. Scan the ENTER/EXIT PROGRAMMING MODE barcode to enter Programming Mode.
4. Go to [page 101](#) and scan the barcode: SELECT RGB AUTO DELAY TIME.
5. Scan the appropriate two digits from the keypad in [Appendix D, Keypad](#), that represent the duration which was determined in the steps above.



**NOTE**

If you make a mistake before the last character, scan the CANCEL barcode to abort and not save the entry string. You can then start again at the beginning.

6. Scan the ENTER/EXIT PROGRAMMING MODE barcode to exit.

This completes the procedure. See the following table for examples of how to set this feature.

**Table 15. RGB Auto Delay Examples**

STEP	ACTION	EXAMPLES			
1	<b>Desired Setting</b>	500ms	1,000ms (1 sec.)	10,000ms (10 sec.)	60,000ms (60 secs.)
2	<b>Divide by 500</b>	01	02	20	120
3	<b>Scan ENTER/EXIT PROGRAMMING MODE</b>				
4	<b>Scan SELECT RGB AUTO DELAY TIME</b>				
5	<b>Scan Two Characters From Appendix D, Keypad</b>	'0' and '1'	'0' and '2'	'2' and '0'	'1', '2' and '0'
6	<b>Scan ENTER/EXIT PROGRAMMING MODE</b>				

---

## Scanning Features

### Scan Mode

Selects the scan operating mode for the reader. Selections are:

**Trigger Single:** When the trigger is pulled, scanning is activated until one of the following occurs:

- Scanning Active Time has elapsed
- a label has been read
- the trigger is released

This mode is associated with typical handheld reader operation: when the trigger is pulled, scanning starts and the product scans until the trigger is released, or a label is read, or the maximum [Scanning Active Time](#) has elapsed.

**Trigger Hold Multiple :** When the trigger is pulled, scanning starts and the product scans until the trigger is released or [Scanning Active Time](#) has elapsed. Reading a label does not disable scanning. [Double Read Timeout](#) prevents undesired multiple reads of the same label while in this mode.

**Trigger Pulse Multiple:** When the trigger is pulled, continuous scanning is activated until [Scanning Active Time](#) has elapsed or the trigger has been released and pulled again. [Double Read Timeout](#) prevents undesired multiple reads of the same label while in this mode.

### Scanning Active Time

This setting specifies the amount of time that the reader stays in scan ON state once the state is entered. The range for this setting is from 1 to 255 seconds in 1-second increments.

Follow these instructions to set this feature:

1. Determine the desired setting.
2. Pad the result with leading zeroes to yield three digits. For example: 0 = 000, 5 = 005, 20 = 020, etc.
3. Scan the ENTER/EXIT PROGRAMMING MODE barcode to enter Programming Mode.
4. Scan the barcode: SELECT SCANNING ACTIVE TIME SETTING on [page 104](#).
5. Scan the appropriate three digits from the keypad in [Appendix D, Keypad](#) that represent the duration which was determined in the steps above. You will hear a two-beep indication after the last character.



#### NOTE

If you make a mistake before the last character, scan the CANCEL barcode to abort and not save the entry string. You can then start again at the beginning.

6. Scan the ENTER/EXIT PROGRAMMING MODE barcode to exit Programming Mode.

This completes the procedure. See the table below for examples of how to set this feature.

**Table 16. Scanning Active Time Setting Examples**

<b>STEP</b>	<b>ACTION</b>	<b>EXAMPLES</b>			
<b>1</b>	<b>Desired Setting</b>	1 Second	90 Sec. (1.5 min.)	180 Sec. (3 min.)	255 Seconds (4.25 min.)
<b>2</b>	<b>Pad leading zero(es)</b>	001	090	180	255
<b>3</b>	<b>Scan ENTER/EXIT PROGRAMMING MODE</b>				
<b>4</b>	<b>Scan SELECT SCANNING ACTIVE TIME SETTING</b>				
<b>5</b>	<b>Scan Three Characters From Appendix D, Keypad</b>	'0', '0' and '1'	'0', '9' and '0'	'1', '8' and '0'	'2', '5' and '5'
<b>6</b>	<b>Scan ENTER/EXIT PROGRAMMING MODE</b>				

# Symbologies

## Set Length

Length Control allows you to select either variable length decoding or fixed length decoding for the specified symbology.

**Variable Length:** For variable length decoding, a minimum and maximum length may be set.

**Fixed Length:** For fixed length decoding, two different lengths may be set.

### Set Length 1

This feature specifies one of the barcode lengths for a given symbology. Length 1 is the minimum label length if in Variable Length Mode, or the first fixed length if in Fixed Length Mode.

Reference the [1D Symbologies on page 105](#) section to view the selectable range (number of characters) for the symbology being set.

Follow these instructions to set this feature:

1. Determine the desired character length. Pad the number with leading zeroes to yield two digits. For example: 0 = 00, 5 = 05, 20 = 20, etc.
2. Scan the ENTER/EXIT PROGRAMMING MODE barcode to enter Programming Mode.
3. Scan the “Select Length 1 Setting” for the symbology being set.
4. Scan the appropriate two digits from the keypad in [Appendix D, Keypad](#), that represent the length setting which was determined in the steps above. You will hear a two-beep indication after the last character.



#### NOTE

If you make a mistake before the last character, scan the CANCEL barcode to abort and not save the entry string. You can then start again at the beginning.

5. Scan the ENTER/EXIT PROGRAMMING MODE barcode to exit Programming Mode.

This completes the procedure. See the table below for examples of how to set this feature.

**Table 17. Length 1 Setting Examples**

STEP	ACTION	EXAMPLES			
1	<b>Desired Setting</b>	01 Character	07 Characters	52 Characters	74 Characters
2	<b>Scan ENTER/EXIT PROGRAMMING MODE</b>				
3	<b>Scan SELECT LENGTH 1SETTING for the desired symbology</b>				
4	<b>Scan Two Characters From Appendix D, Keypad</b>	'0' and '1'	'0' and '7'	'5' and '2'	'7' AND '4'
5	<b>Scan ENTER/EXIT PROGRAMMING MODE</b>				



## Set Length 2

This feature specifies one of the barcode lengths for a given symbology. Length 2 is the maximum label length if in Variable Length Mode, or the second fixed length if in Fixed Length Mode.

Reference the [1D Symbologies on page 105](#) section to view the selectable range (number of characters) for the symbology being set. A setting of 00 specifies to ignore this length (only one fixed length).

Follow these instructions to set this feature:

1. Determine the desired character length. Pad the number with leading zeroes to yield two digits. For example: 0 = 00, 5 = 05, 20 = 20, etc.
2. Scan the ENTER/EXIT PROGRAMMING MODE barcode to enter Programming Mode.
3. Scan the “Select Length 2 Setting” for the symbology being set.
4. Scan the appropriate two digits from the keypad in [Appendix D, Keypad](#), that represent the length setting which was determined in the steps above. You will hear a two-beep indication after the last character.



### NOTE

If you make a mistake before the last character, scan the CANCEL barcode to abort and not save the entry string. You can then start again at the beginning.

5. Scan the ENTER/EXIT PROGRAMMING MODE barcode to exit Programming Mode.

This completes the procedure. See the table below for examples of how to set this feature.

**Table 18. Length 2 Setting Examples**

STEP	ACTION	EXAMPLES			
1	Desired Setting	00 (ignore second length)	07 Characters	52 Characters	74 Characters
2	Scan ENTER/EXIT PROGRAMMING MODE				
3	Scan SELECT LENGTH 2 SETTING				
4	Scan Two Characters From Appendix D, Keypad	'0' and '0'	'0' and '7'	'5' and '2'	'7' and '4'
5	Scan ENTER/EXIT PROGRAMMING MODE				

# NOTES

# Wireless Features

This section provides options and programming related to the reader's wireless communication features. Reference [Appendix B](#), for a listing of standard factory settings.

## **WIRELESS BEEPER FEATURES** starting on page 252

- Good Transmission Beep on page 252
- Beep Frequency on page 252
- Beep Duration on page 253
- Beep Volume on page 254
- Disconnect Beep on page 254
- Docking Beep on page 255
- Leash Alarm on page 255

## **CONFIGURATION UPDATES** starting on page 257

- Automatic Configuration Update on page 257
- Copy Configuration to Scanner on page 257
- Copy Configuration to Base Station on page 257

## **BATCH FEATURES** starting on page 258

- Batch Mode on page 258
- Send Batch on page 258
- Erase Batch Memory on page 259
- RF Batch Mode Transmit Delay on page 259

## **DIRECT RADIO AUTOLINK** starting on page 260

## **RF ADDRESS STAMPING** starting on page 261

- Source Radio Address Transmission on page 261
- Source Radio Address Delimiter Character on page 261

## **BT SECURITY FEATURES** starting on page 262

- BT Security Level on page 262
- BT PIN Code on page 264
- Select PIN Code Length on page 264
- Set PIN Code on page 264

## **OTHER BT FEATURES** starting on page 265

- Bluetooth HID Alt Mode on page 265
- Bluetooth HID Alt Mode on page 265
- HID Country Mode on page 266
- HID Country Mode on page 266
- Powerdown Timeout on page 269



## WIRELESS BEEPER FEATURES

Several options are available to configure beeper behavior for RF operation.

### Good Transmission Beep

Enables/disables the Good Transmission Beep indication. When enabled, a beep occurs when a Label is correctly transmitted to the base.



### Beep Frequency

Adjusts radio-specific beep indications to sound at a low, medium or high frequency, selectable from the list below (controls the beeper's pitch/tone).

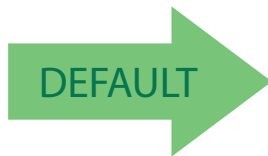

## Beep Duration

This feature controls the duration of radio-specific beep indications.





## Beep Volume

Selects the beeper volume (loudness) of radio-specific beep indications. There are three selectable volume levels.



Beep Volume = Low



Beep Volume = Medium



Beep Volume = High



## Disconnect Beep

Enables/disables the beep indication that a handheld has become connected or disconnected from a Base Station or a Host.



Disconnect Beep = Disable



Disconnect Beep = Enable



### Docking Beep

Enables/disables a beep indication when the handheld is placed in the Base Station.



### Leash Alarm

This setting specifies the number of seconds to sound the Leash Mode beeps (three per second) when the handheld goes out of range. This is especially useful in instances where the reader might inadvertently have been placed in a bag or cart.

For this mode to be effective, the reader must be linked to the Base Station or to the Host. If the reader is asleep or disconnected from the Base Station, there is no way for it to know where it is relative to the Base Station because communication is not active between the devices.

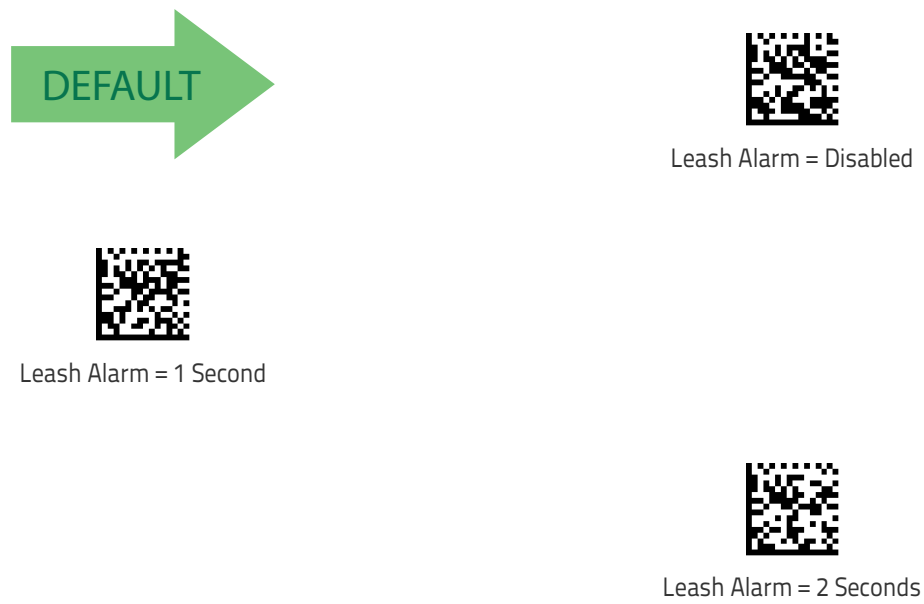



Enter/Exit Programming Mode

---

## Leash Alarm (continued)



Leash Alarm = 3 Seconds



Leash Alarm = 4 Seconds



Leash Alarm = 5 Seconds



Leash Alarm = 10 Seconds



Leash Alarm = 25 Seconds



Leash Alarm = 30 Seconds



## CONFIGURATION UPDATES

### Automatic Configuration Update

When this feature is enabled, a reader and its linked Base Station can automatically ensure they stay in sync with regard to application hardware and/or configuration.



Automatic Configuration Update = Disable



Automatic Configuration Update = Enable



### Copy Configuration to Scanner

Scan the following label to copy the current Base Station configuration to the scanner. Use this method when the Auto Configuration Update feature is disabled and you want a one-time configuration update to be performed on the scanner.



**Do not scan an ENTER/EXIT PROGRAMMING MODE label in conjunction with this barcode.**

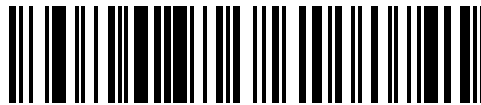

Copy Configuration to Scanner

### Copy Configuration to Base Station

Scan the following label to copy the current scanner configuration to the Base Station. Use this method when the Auto Configuration Update feature is disabled and you want a one-time configuration update to be performed on the Base Station.

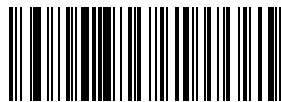

Copy Configuration to Base Station



**Do not scan an ENTER/EXIT PROGRAMMING MODE label with this barcode.**



## BATCH FEATURES

### Batch Mode

This option specifies whether to store labels in the handheld while disconnected from the base. Options are as follows:

- Disabled — The handheld will not store/batch labels.
- Automatic — The handheld will store labels in its internal memory when the handheld goes out of range and is disconnected from the remote device. When the connection is restored, the labels are immediately transmitted to the remote device.
- Manual — The handheld will always store labels to Flash memory. The user must manually send the stored labels to the remote device using a special "batch send" label.

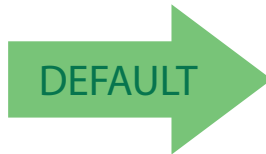

Batch Mode = Disabled



Batch Mode = Automatic



Batch Mode = Manual

### Send Batch

When the scanner is configured in Manual Batch Mode, use the following barcode to initiate sending of labels stored in batch memory.



**Do not scan an ENTER/EXIT PROGRAMMING MODE label in conjunction with this barcode.**



Send Batch

## Erase Batch Memory

When the scanner is configured in Manual Batch Mode, use the following barcode to erase any labels stored in batch memory.



Do not scan an ENTER/EXIT PROGRAMMING MODE label in conjunction with this barcode.



Erase Batch Memory



It is strongly recommended to connect the reader with a micro USB cable to the Host before scanning the "Download Batch Queue" label or, if the base station is available, to place the reader over the base just after the scan.



Batch settings override Leash Mode beep settings.

## RF Batch Mode Transmit Delay

Specifies the delay in 10 msec increments between transmitting labels stored in batch memory.

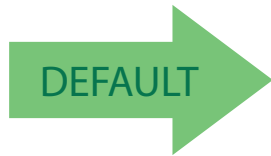

RF Batch Mode Transmit Delay = No Delay



RF Batch Mode Transmit Delay = 50 mS



RF Batch Mode Transmit Delay = 100 mS



Enter/Exit Programming Mode

---

## RF Batch Mode Transmit Delay (continued)



RF Batch Mode Transmit Delay = 0.5 seconds



RF Batch Mode Transmit Delay = 1 second



RF Batch Mode Transmit Delay = 2.5 seconds

## DIRECT RADIO AUTOLINK

This feature enables/disables the ability to link a wireless handheld to a base station without scanning the Unlink label first.



Direct Radio Link = Unlink Label Required



Direct Radio Link = Automatic Unlinking



## RF ADDRESS STAMPING

These features allow configuration of source radio data inclusion.

### Source Radio Address Transmission

Enables/disables the ability of source radio address information to be transmitted to the host and, if so, at what position with respect to the label data.



When included as a prefix, the source-radio ID is displayed after all label formatting has been applied. The 6 byte hex address is sent as 12 ascii characters, i.e., an address of 00 06 66 00 1A ED will be sent as (shown in hex): 30 30 30 36 36 36 30 30 31 41 45 44

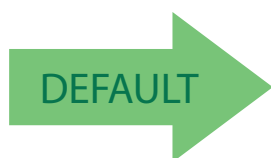

Source Radio Address Transmission = Do Not Include



Source Radio Address Transmission = Prefix

### Source Radio Address Delimiter Character

This option specifies the delimiter character to be placed between the label data and radio address when address stamping is enabled.



This feature only applies if "Source Radio Address Transmission" on page 261 is enabled.



Set Source Radio Address Delimiter Character

To configure this feature, scan the ENTER/EXIT PROGRAMMING MODE bar code above, then the bar code at left followed by the digits from the Alphanumeric characters in [Appendix D, Keypad](#) representing your desired character(s). End by scanning the ENTER/EXIT bar code again.

Make a mistake? Scan the CANCEL bar code to abort and not save the entry string. You can then start again at the beginning.



CANCEL

**00 = No Delimiter Character**



## BT SECURITY FEATURES



The features and the parameters described in this section have no effect when pairing the Reader to a Base station.

### BT Security Level

Set this parameter according to the version of the Bluetooth Core Specifications supported by the Host device and to the security requirements of the application scenario. If the Host system is compliant to Bluetooth Core Specifications v2.0 + EDR or earlier, set this parameter to **Support pre-v2.1 remote devices**. In this case you may need to set the BT PIN code of the reader following the instructions in the sections "**BT PIN Code**" on page 264 and "**Set PIN Code**" on page 264.

If the Host system is compliant to the Bluetooth Core Specifications v2.1 + EDR or later, set this parameter according to the security requirements of the application scenario.

- Select **Encryption required, authentication not required** when minimal user interaction is desired.
- Select **Encryption and authentication required** when a secure connection to the Host is desired, with protection from Man-In-The-Middle (MITM) attacks. In this case the Host will ask the user to enter a 6-digit Bluetooth Passkey during the pairing process. Please, refer to "**Bluetooth Passkey Request**" on page 10 to perform this task.



The actual behaviors of the Reader and of the Host system during the pairing process depend on the security settings of both devices involved, and on the input and output means available on each device to interface with the user. This means that:

- the user may be required to enter a BT Passkey during the pairing process even if the reader's BT Security Level is set to "Encryption required, authentication not required". This depends on the configuration of the Host system.
- when the reader's BT Security Level is set to "Encryption and authentication required", it may not be possible to connect to a Host system if the latter cannot support the Passkey Entry authentication procedure. In this case, try to set the reader's BT Security Level to "Encryption required, authentication not required" to establish the connection.



Changing the BT Security Level setting will unlink the Reader from the remote device.



BT Security level = Support pre-v2.1 remote devices



BT Security level = Encryption required, authentication not required



BT Security level = Encryption and authentication required

## Legacy pairing with remote devices compliant to Bluetooth v. 2.0+EDR or earlier

On the BT Reader, it is possible to set a (configurable) PIN code to authenticate/connect BT devices, compliant to Bluetooth Core Specification v2.0 + EDR or earlier, and encrypt the data.

The BT PIN code can be configured by reading the barcodes in the following sections.



If you are using a BT scanner directly connected to a host through a BT dongle compliant to Bluetooth Core Specification v2.0 + EDR or earlier, verify that the scanner and the BT driver used by the dongle share the same PIN code and the same security level. Otherwise the connection cannot be established.

Follow these steps to enable the legacy pairing and set the PIN code for a scanner:

1. Set the BT Security Level by scanning the **Support pre-v2.1 remote devices** barcode in the previous section.
2. Select a PIN code length of either 4 or 16 characters by scanning the appropriate barcode in "Select PIN Code Length" on page 264.
3. Scan the relevant barcode from "Set PIN Code" on page 264, then scan the desired alphanumeric characters from the keypad in [Appendix D, Keypad](#) to set the PIN code.



## Enter/Exit Programming Mode

### BT PIN Code

After enabling Security Mode (see "BT Security Level" on page 262), specify whether you want to set a 4-digit or a 16-digit PIN Code.

### Select PIN Code Length



Select 4-character BT PIN Code



DEFAULT



Select 16-character BT PIN Code

### Set PIN Code

Determine the desired characters for the PIN code, then convert to hexadecimal using the ASCII Chart on the inside back cover of this manual.



Set 4-character BT PIN Code

To configure this feature, scan the ENTER/EXIT PROGRAMMING MODE barcode above, then the barcode at left followed by the digits from the Alphanumeric characters in **Appendix D, Keypad** representing your desired character(s). End by scanning the ENTER/EXIT barcode again.



Set 16-character BT PIN Code



CANCEL

Make a mistake? Scan the CANCEL barcode to abort and not save the entry string. You can then start again at the beginning.



DEFAULT

**31323334 = Default PIN Code is 1234**





## OTHER BT FEATURES

### Bluetooth HID Alt Mode

Enable/Disable the ability to correctly transmit a label to the host regardless of the Bluetooth HID Country Mode selected, when Bluetooth HID Profile is configured.

Read the configuration command label below for the HID Alt Mode feature.



HID Alt Mode = OFF



HID Alt Mode = ON



## HID Country Mode

When the Reader is connected with a Bluetooth Adapter in HID mode, you may want to set the country for which your PC is localized. In order to do that, read one of the configuration command labels below.



Country Mode = U.S.



Country Mode = Belgium



Country Mode = Britain



Country Mode = Croatia



Country Mode = Czech Republic



Country Mode = Denmark



Country Mode = France



## HID Country Mode (Continued)



Country Mode = French Canadian



Country Mode = Germany



Country Mode = Hungary



Country Mode = Italy



Country Mode = Japanese 106-key



Country Mode = Lithuanian



Country Mode = Norway



Country Mode = Poland



## HID Country Mode (Continued)



Country Mode = Portugal



Country Mode = Romania



Country Mode = Spain



Country Mode = Sweden



Country Mode = Slovakia



Country Mode = Switzerland

### Powerdown Timeout

The Powerdown Timeout feature sets the time for automatically switching the unit off when the imager has been idle.



Powerdown Timeout = 10 minutes



Powerdown Timeout = 20 minutes



Powerdown Timeout = 30 minutes



Powerdown Timeout = 60 Minutes (1 Hour)



Powerdown Timeout = 120 Minutes (2 Hours)



## Automatic Reconnection

When the handheld goes out of range it's disconnected from the remote device. When Automatic Reconnection feature is enable the handheld try, with a timeout, reconnection with the remote device.



Automatic Reconnection = Enable



Automatic Reconnection = Disable



**The Automatic Reconnection is not performed in case the remote device performs a voluntary disconnection.**



## Appendix A

# Technical Specifications

The table below contains Physical and Performance Characteristics, User Environment and Regulatory information.

**Table 19. Technical Specifications**

Item	Description
<b>Electrical Features</b>	
Battery Type	Li-Ion battery pack.
Typical charge time for full charge from auto power off	2,5 hours when placed on Based Station or when Host powered through the micro USB cable connection <sup>a</sup> .
Operating autonomy (continuous reading)	4000 readings or 5 hour connected to a Host. (with aggressive power saving profile).
Max. Scan Rate	60 frames/sec.
Reading Indicators	Side and Top Illumination, Good Read Spot, Beep, Jingle or Viber.
Cradle Consumption and DC input supply range	5V +/- 10%; Power < 8W (b); Max 500mA when in host/bus powered mode <sup>b</sup> .

<sup>a</sup>. Charge times are much lower when battery is within daily typical operating condition.

<sup>b</sup>. Typical input current measured under factory default configuration.

Item	Description
<b>Optical Features</b>	
Optical Format	1/3-inch
Active Imager Size	4.51 mm (H) x 2.88 mm (V)
Active Pixels	752 H x 480 V
Illumination System	LED source White emission (wavelength = 400-750 nm) IEC 62471 - EXEMPT RISK GROUP
Aiming System	Laser source Red emission (wavelength = 630-680 nm) Pulsed source: maximum lamp duration 15ms, repetition rate 16.6 ms Maximum emitted power: 1 mW IEC 60825 - CLASS 2 LASER PRODUCT
Tilt Tolerance	Up to $\pm 360^\circ$
Pitch Tolerance	$\pm 65^\circ$
Skew Tolerance	$\pm 60^\circ$
Field of View	40° H x 26° V
DOF Depth of Field (Typical)	Code 39: 5 mil, 55 mm - 200 mm (2.2" - 7.9") Code 39: 20 mil, FOV ltd - 400 mm (FOV ltd - 15.7") EAN13: 13 mil, 50 mm - 365 mm (2" - 14") DataMatrix: 15 mil, 40 mm - 250 mm (1.6" - 9.8")
Max. Resolution	Code 39, 3 mil, at 105 mm (4.1")
PCS (Datalogic Test Chart)	Minimum 15%



Item	Description
<b>Environmental Features</b>	
Working Temperature	0° C to +50° C (+32° to +122° F)
Storage Temperature	-20° C to +70° C (-4° to +158° F)
Charging Temperature	0° C to +40° C (32° to +104° F)
Humidity	90% non condensing
Drop Resistance	IEC 68-2-32 Test ED Scanner: 1.5 m (4.9 ft) Base Station: 0.9 m (3 ft)
ESD Protection	16 KV for the reader
Protection Class	Scanner: IP50 Base Station: IP40
Weight (without cable)	Scanner: approx. 150g (5.3 oz) Base Station: approx. 103g (3.6 oz)
Size	Scanner: approx 110 x 43 x 35 mm Base Station: approx. 71 x 70 x 69 mm
<b>Radio Features</b>	
Frequency Range	2400 to 2483.5 MHz
Range (in open air)	25 m

Item	Description
	<b>Decode Capability</b>
	<p><b>1D barcodes</b></p> <p>UPC/EAN/JAN (A, E, 13,8); UPC/EAN/JAN (including P2 / P5); UPC/EAN/JAN (including; ISBN / Bookland &amp; ISSN); UPC/EAN Coupons; Code 39 (including full ASCII); Code 39 Trioptic; Code39 CIP (French Pharmaceutical); LOGMARS (Code 39 w/ standard check digit enabled); Danish PPT; Code 32 (Italian Pharmacode</p> <p>39); Code 128; Code 128 ISBT; Interleaved 2 of 5; Standard 2 of 5; Interleaved 2 of 5 CIP (HR); Industrial 2 of 5; Discrete 2 of 5; Matrix 2 of 5; IATA 2of5 Air cargo code; Code 11; Codabar; Codabar (NW7); ABC Codabar; EAN 128; Code 93; MSI; PZN; Plessey; Anker Plessey; GS1 DataBar Omnidirectional; GS1 DataBar Limited; GS1 DataBar Expanded; GS1 DataBar Truncated; DATABAR Expanded Coupon.</p>
	<p><b>2D / Stacked Codes</b></p> <p>The Rida DBT6400 scanner is capable of decoding the following symbologies using multiple frames (i.e. Multi-Frame Decoding):</p> <p>Datamatrix; Inverse Datamatrix; Datamatrix is configurable for the following parameters; Normal or Inverted; Square or Rectangular Style; Data length (1 - 3600 characters); Maxicode; QR Codes (QR, Micro QR and Multiple QR Codes); Aztec; Postal Codes - (Australian Post; Japanese Post; KIX Post; Planet Code; Postnet; Royal Mail Code (RM45CC); Intelligent Mail Barcode (IMB); Sweden Post; Portugal Post); LaPoste A/R 39; PDF-417; MacroPDF; Micro PDF417; GS1 Composites (1 - 12); French CIP13<sup>a</sup>; GS1 DataBar Stacked; GS1 DataBar Stacked Omnidirectional; GS1 DataBar Expanded Stacked; GS1 Databar Composites; Chinese Sensible Code; Inverted 2D codes<sup>b</sup>.</p>

<sup>a</sup>. It is acceptable to handle this with ULE.

<sup>b</sup>. The SW can apply the Normal/Reverse Decoding Control to the following symbologies: Datamatrix, QR, Micro QR, Aztec and Chinese Sensible Code.

## LED and Beeper Indications

The reader's beeper sounds and its LED illuminates to indicate various functions or errors on the reader. An optional "Green Spot" also performs useful functions. The following tables list these indications. One exception to the behaviors listed in the tables is that the reader's functions are programmable, and so may or may not be turned on. For example, certain indications such as the power-up beep can be disabled using programming barcode labels.

**Table 20. LED and Speaker Indications**

Indication	Description	LED	Beeper
Power-up Beep	The reader is in the process of powering-up.	Fast RGB loop for Top Led.	Reader beeps four times at highest frequency and volume upon power-up.
Good Read Beep	A label has been successfully scanned by the reader.	LED behavior for this indication is configurable via the feature 'Good Read: When to Indicate'.	The reader will beep once at current frequency, volume, mono/bi-tonal setting and duration upon a successful label scan.
ROM Failure	There is an error in the reader's software/programming.	Top Led Flashes.	Reader sounds one error beep at highest volume.
Limited Scanning Label Read	Indicates that a Host connection is not established when the USB interface is enabled.	N/A	Reader 'chirps' six times at the highest frequency and current volume.
Reader Active Mode	The reader is active and ready to scan.	Side LED is lit steadily <sup>a</sup> .	N/A
Reader Disabled	The reader has been disabled by the Host.	Top LED blinks continuously.	N/A
Green Spot <sup>a</sup> flashes momentarily	Upon successful read of a label, the software shall turn the green spot on for the time specified by the configured value.	Upon successful read of a label, the software shall turn the green spot on for the time specified by the configured value.	N/A
Battery charging in progress	Charging battery	Side LEDs blink green	N/A
Battery charging completed	End of battery charging process	Side LEDs are solid green	Reader beeps two times at highest frequency.

<sup>a</sup>. Except when in sleep mode or when a Good Read LED Duration other than 00 is selected.

## Programming Mode

The following indications ONLY occur when the reader is in Programming Mode.

INDICATION	DESCRIPTION	LED	BEEPER
Label Programming Mode Entry	A valid programming label has been scanned.	LED blinks continuously.	Reader sounds four low frequency beeps.
Label Programming Mode Rejection of Label	A label has been rejected.	N/A	Reader sounds three times at lowest frequency and current volume.
Label Programming Mode Acceptance of Partial Label	In cases where multiple labels must be scanned to program one feature, this indication acknowledges each portion as it is successfully scanned.	N/A	Reader sounds one short beep at highest frequency and current volume.
Label Programming Mode Acceptance of Programming	Configuration option(s) have been successfully programmed via labels and the reader has exited Programming Mode.	N/A	Reader sounds one high frequency beep and 4 low frequency beeps followed by reset beeps.
Label Programming Mode Cancel Item Entry	Cancel label has been scanned.	N/A	Reader sounds two times at low frequency and current volume.

**Base Station Indications**

Indication	LEDs
Power-up Complete.	Yellow LED on.
Reader Disabled by the HOST or the communication with HOST is not established.	Yellow LED blinking ~1Hz.
Data/labels are transmitted to the HOST.	Yellow LEDs turned off for 100mSec.
Programming Mode.	Yellow LED blinks quickly.
Configuration alignment with the HH is in progress.	Red LED blinks quickly.
Battery charge in progress.	Green LED on.
Battery charge complete.	Green LED on.
No HH is placed on the cradle.	Red and Green LEDs off.

# NOTES



# Appendix B

## Standard Defaults

The most common configuration settings are listed in the “Default” column of the table below. Page references are also provided for feature descriptions and programming barcodes for each parameter. A column has also been provided for recording of your preferred default settings for these same configurable features.

**Table 21. Standard Defaults**

Parameter	Default	Your Setting	Page Number
<b>GLOBAL INTERFACE FEATURES</b>			
Host Commands — Obey/Ignore	Obey		23
USB Suspend Mode	Disable		24
<b>USB-COM</b>			
Intercharacter Delay	No Delay		26
Beep On ASCII BEL	Disable		27
Beep On Not on File	Enable		27
ACK NAK Options	Disable		28
ACK Character	'ACK'		29
NAK Character	'NAK'		29
ACK NAK Timeout Value	200 ms		30
ACK NAK Retry Count	3 Retries		31
ACK NAK Error Handling	Ignore Errors Detected		32
Indicate Transmission Failure	Enable		33
Disable Character	'D'		33
Enable Character	'E'		34
<b>KEYBOARD</b>			
Country Mode	U.S. Keyboard		36
Keyboard Send Control Characters	00		60
Intercharacter Delay	100 ms		61
Intercode Delay	No Delay		62

## Standard Defaults

Parameter	Default	Your Setting	Page Number
Caps Lock State	Caps Lock OFF		58
Numlock	NumLock Key Unchanged		59
USB Keyboard Speed	1 ms		63
Keyboard Numeric Keypad	Standard Keys		59
<b>USB-OEM</b>			
USB-OEM Device Usage	Handheld		66
USB-OEM Interface Options	Ignore Scanner Configuration Host Commands		66
<b>DATA FORMAT</b>			
Global Prefix/Suffix	No Global Prefix Global Suffix = 0x0D (CR)		68
Global AIM ID	Disable		69
GS1-128 AIM ID	Enable		69
Label ID: Pre-loaded Sets	EU Set		70
Label ID: Pre-loaded Sets	Disable		70
Case Conversion	Disable		78
Character Conversion	No Char Conversion		78
<b>READING PARAMETERS</b>			
Double Read Timeout	0.6 Second		80
Power On Alert	Power-up Beep		82
Good Read: When to Indicate	After Decode		89
Good Read Beep Type	Mono		90
Good Read Beep Frequency	High		90
Good Read Beep Length	80 ms		92
Good Read Speaker Volume	High		91
RGB LED Settings	300 ms		94
Viber	Disable		102
<b>SCANNING FEATURES</b>			
Scan Mode	Trigger Single		103
Scanning Active Time	5 Seconds		104



<b>Parameter</b>	<b>Default</b>	<b>Your Setting</b>	<b>Page Number</b>
Pick Mode	Disable		104
<b>CODE SELECTION - 1D SYMBOLOGIES</b>			
<b>Code EAN/UPC</b>			
Coupon Control	Enable only UPCA coupon decoding		106
<b>UPC-A</b>			
UPC-A Enable/Disable	Enable		107
UPC-A Check Character Transmission	Send		107
Expand UPC-A to EAN-13	Don't Expand		108
UPC-A Number System Character Transmission	Transmit		108
<b>UPC-E</b>			
UPC-E Enable/Disable	Enable		109
UPC-E Check Character Transmission	Send		109
Expand UPC-E to EAN-13	Don't Expand		110
Expand UPC-E to UPC-A	Don't Expand		110
UPC-E Number System Character Transmission	Transmit		111
<b>GTIN</b>			
EAN 13	Disable		112

Parameter	Default	Your Setting	Page Number
<b>EAN 13 (Jan 13)</b>			
EAN 13 Enable/Disable	Enable		112
EAN 13 Check Character Transmission	Send		112
EAN-13 Flag 1 Character	Transmit		113
EAN-13 ISBN Conversion	Disable		113
<b>ISSN</b>			
ISSN Enable/Disable	Disable		114
<b>EAN 8</b>			
EAN 8 Enable/Disable	Enable		115
EAN 8 Check Character Transmission	Send		115
Expand EAN 8 to EAN 13	Disable		116
<b>UPC/EAN Global Settings</b>			
UPC/EAN Price Weight Check	Disable		117
<b>Add-Ons</b>			
Optional Add-ons	Disable P2, P5 and P8		118
Optional Add-On Timer	70 ms		119
<b>Code 39</b>			
Code 39 Enable/Disable	Enable		125
Code 39 Check Character Calculation	Disable		126
Code 39 Check Character Transmission	Send		127
Code 39 Start/Stop Character Transmission	Don't Transmit		127
Code 39 Full ASCII	Disable		128
Code 39 Quiet Zones	Small Quiet Zones on two sides		129
Code 39 Length Control	Variable		130
Code 39 Set Length 1	2		131
Code 39 Set Length 2	50		132
<b>Code 32 (Italian Pharmaceutical Code)</b>			
Code 32 Enable/Disable	Disable		133

Parameter	Default	Your Setting	Page Number
Code 32 Check Character Transmission	Don't Send		133
Code 32 Start/Stop Character Transmission	Don't Transmit		134
<b>Code 39 CIP (French Pharmaceutical Code)</b>			
Code 39 CIP Enable/Disable	Disable		134
<b>Special Codes</b>			
<b>Code 128</b>			
Code 128 Enable/Disable	Enable		135
Expand Code 128 to Code 39	Don't Expand		135
Code 128 Check Character Transmission	Don't Send		136
Code 128 Function Character Transmission	Don't Send		136
Code 128 Quiet Zones	Small Quiet Zones on two sides		137
Code 128 Length Control	Variable		138
Code 128 Set Length 1	1		139
Code 128 Set Length 2	80		140
<b>GS1-128</b>			
GS1-128 Enable	Transmit in Code 128 Data Format		141
<b>ISBT 128</b>			
ISBT 128 Concatenation	Disable		175
ISBT 128 Force Concatenation	Disable		177
ISBT 128 Concatenation Mode	Static		175
ISBT 128 Dynamic Concatenation Timeout	200 msec		176
<b>Interleaved 2 of 5</b>			
I 2 of 5 Enable/Disable	Disable		142
I 2 of 5 Check Character Calculation	Disable		143
I 2 of 5 Check Character Transmission	Send		144
I 2 of 5 Length Control	Variable		145

Standard Defaults

Parameter	Default	Your Setting	Page Number
I 2 of 5 Set Length 1	6		146
I 2 of 5 Set Length 2	50		147
<b>Interleaved 2 of 5 CIP HR</b>			
Interleaved 2 of 5 CIP HR Enable/Disable	Disable		148
<b>Follett 2 of 5</b>			
Follett 2 of 5 Enable/Disable	Disable		188
<b>Standard 2 of 5</b>			
Standard 2 of 5 Enable/Disable	Disable		166
Standard 2 of 5 Check Character Calculation	Disable		166
Standard 2 of 5 Check Character Transmission	Send		167
Standard 2 of 5 Length Control	Variable		167
Standard 2 of 5 Length Control	8		167
Standard 2 of 5 Set Length 2	50		169
<b>Industrial 2 of 5</b>			
Industrial 2 of 5 Enable/Disable	Disable		170
Industrial 2 of 5 Check Character Calculation	Disable		170
Industrial 2 of 5 Check Character Transmission	Enable		171
Industrial 2 of 5 Length Control	Variable		171
Industrial 2 of 5 Set Length 1	1		172
Industrial 2 of 5 Set Length 2	50		173
<b>Code IATA</b>			
IATA Enable/Disable	Disable		174
IATA Check Character Transmission	Enable		174

Parameter	Default	Your Setting	Page Number
<b>Codabar</b>			
Codabar Enable/Disable	Disable		153
Codabar Check Character Calculation	Don't Calculate		153
Codabar Check Character Transmission	Send		154
Codabar Start/Stop Character Transmission	Transmit		154
Codabar Start/Stop Character Set	abcd/abcd		155
Codabar Start/Stop Character Match	Don't Require Match		155
Codabar Quiet Zones	Small Quiet Zones on two sides		156
Codabar Length Control	Variable		157
Codabar Set Length 1	3		158
Codabar Set Length 2	50		159
<b>ABC Codabar</b>			
ABC Codabar Enable/Disable	Disable		160
ABC Codabar Concatenation Mode	Static		160
ABC Codabar Dynamic Concatenation Timeout	200 msec		161
ABC Codabar Force Concatenation	Disable		161
<b>Code 11</b>			
Code 11 Enable/Disable	Disable		162
Code 11 Check Character Calculation	Check C and K		163
Code 11 Check Character Transmission	Send		163
Code 11 Length Control	Variable		164
Code 11 Set Length 1	4		164
Code 11 Set Length 2	50		165
<b>GS1 DataBar Omnidirectional</b>			
GS1 DataBar Omnidirectional Enable/Disable	Disable		120
GS1 DataBar Omnidirectional GS1-128 Emulation	Disable		120

Parameter	Default	Your Setting	Page Number
<b>GS1 DataBar™ Expanded</b>			
GS1 DataBar Expanded Enable/Disable	Disable		121
GS1 DataBar Expanded GS1-128 Emulation	Disable		121
	2D component not required		121
GS1 DataBar Expanded Length Control	Variable		122
GS1 DataBar Expanded Set Length 1	1		122
GS1 DataBar Expanded Set Length 2	74		123
<b>GS1 DataBar™ Limited</b>			
GS1 DataBar Limited Enable/Disable	Disable		124
GS1 DataBar Limited GS1-128 Emulation	Disable		124
<b>Code 93</b>			
Code 93 Enable/Disable	Disable		182
Code 93 Check Character Calculation	Enable Check C and K		183
Code 93 Check Character Transmission	Disable		183
Code 93 Length Control	Variable		184
Code 93 Set Length 1	1		185
Code 93 Set Length 2	50		186
Code 93 Quiet Zones	Small Quiet Zones on two sides		187
<b>MSI</b>			
MSI Enable/Disable	Disable		178
MSI Check Character Calculation	Enable Mod10		178
MSI Check Character Transmission	Enable		179
MSI Length Control	Variable		179
MSI Set Length 1	1		180
MSI Set Length 2	50		181

## Default Exceptions

Table 22. Default Exceptions by Interface Type

Parameter	Default Exception
<b>Interfaces: USB-OEM</b>	
Global Suffix	No Global Suffix
Double Read Timeout	500 msec
<b>Interfaces: USB Keyboard</b>	
No unique settings	
<b>Interface: RS232-WN</b>	
Expand UPC-A to EAN-13	Enable
UPC-E Check Character Transmission	Disable
Parity	Odd Parity
Handshaking Control	RTS/CTS
Transmission Label ID Code	Prefix
GS1-128 AIM ID	Disable
UPCE Label ID Character(s)	C
EAN 8 Label ID Character(s)	B
EAN 13 Label ID Character(s)	A
Code ISBN Label ID Character(s)	A
Code 39 Label ID Character(s)	M
Interleaved 2of5 Label ID Character(s)	I
Code Standard 2/5 Label ID Character(s)	H
Codabar Label ID Character(s)	N
Code 128 Label ID Character(s)	K
GS1-128 Label ID Character(s)	P
Datalogic 2 of 5 Label ID Character(s)	H
ISBT 128 Label ID Character(s)	K
UPCE P2 Label ID Character(s)	C
UPCE/P5 Label ID Character(s)	C
UPCE/GS1-128 Label ID Character(s)	C

## Standard Defaults

Parameter	Default Exception
EAN8/P2 Label ID Character(s)	B
EAN8/P5 Label ID Character(s)	B
EAN8/GS1-128 Label ID Character(s)	B
EAN13/P2 Label ID Character(s)	A
EAN13/P5 Label ID Character(s)	A
EAN13/GS1-128 Label ID Character(s)	A
GS1 DataBar 14 (Omnidirectional) Label ID Character(s)	E
GS1 DataBar Expanded Label ID Character(s)	E
GS1 DataBar Limited Label ID Character(s)	E
Character Conversion	CR to `
<b>Interface: RS232-OPOS</b>	
Baud Rate	115200 Baud
Transmission Label ID Code	Prefix
GS1-128 AIM ID	Disable
UPCA Label ID Character(s)	C
UPCE Label ID Character(s)	D
EAN 8 Label ID Character(s)	A
EAN 13 Label ID Character(s)	B
Code ISBN Label ID Character(s)	@
Code 39 Label ID Character(s)	V
Code 32 Label ID Character(s)	X
Interleaved 2of5 Label ID Character(s)	N
Code Standard 2/5 Label ID Character(s)	P
Codabar Label ID Character(s)	R
Code 11 Label ID Character(s)	b
Code 128 Label ID Character(s)	T
GS1-128 Label ID Character(s)	k
UPCA/P2 Label ID Character(s)	F
UPCA/P5 Label ID Character(s)	G



Parameter	Default Exception
UPCA/GS1-128 Label ID Character(s)	Q
UPCE P2 Label ID Character(s)	H
UPCE/P5 Label ID Character(s)	I
EAN8/P2 Label ID Character(s)	J
EAN8/P5 Label ID Character(s)	K
EAN8/GS1-128 Label ID Character(s)	*
EAN13/P2 Label ID Character(s)	L
EAN13/P5 Label ID Character(s)	M
EAN13/GS1-128 Label ID Character(s)	#
GS1 DataBar 14 (Omnidirectional) Label ID Character(s)	u
GS1 DataBar Expanded Label ID Character(s)	t
GS1 DataBar Limited Label ID Character(s)	v

# NOTES



# Appendix C

## Sample barcodes

The sample barcodes in this appendix are typical representations for their symbology types.

### 1D barcodes

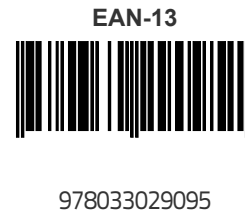

## Sample barcodes (continued)

Code 32

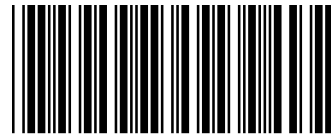

B9P91Q

Codabar

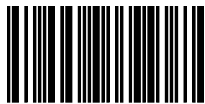

13579

Code 93



ABCDEF

Code 11



123456789

---

## GS1 DataBar™ (RSS)



GS1 DataBar™ variants must be enabled to read the barcodes below (see "GS1 DataBar™ Omnidirectional" on page 120).

GS1 DataBar™ Expanded Stacked



10293847560192837465019283746029478450366523

GS1 DataBar™ Expanded



1234890hgio9900mnb

GS1 DataBar™ Limited



08672345650916

## GS1 DataBar™-14

GS1 DataBar™ Omnidirectional Truncated



55432198673467

GS1 DataBar™ Omnidirectional Stacked



90876523412674

GS1 DataBar™ Omnidirectional Stacked



78123465709811

## 2D barcodes

Aztec



Datamatrix



China Sensible Code



MaxiCode

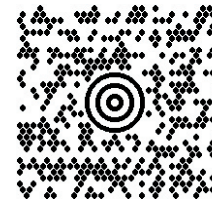

*Test Message*

PDF 417



ABCabc

Micro PDF 417



BV17453

QR Code

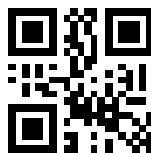

35900G9

Micro QR Code



123456

UCC Composite

(17) 050923 (10) ABC123



(01) 0 4012345 67890 1 1



## Appendix D Keypad

Use the barcodes in this appendix to enter numbers as you would select digits/characters from a keypad.



0



1

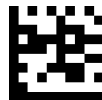

2



3



4



5

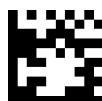

6



7



8



9



A



B



C



D



E



F





# Appendix E

## Scancode Tables

### Control Character Emulation

Control character emulation selects from different scancode tables as listed in this appendix. Each of the control character sets below are detailed by interface type in the tables. These apply to Wedge and USB Keyboard platforms.

**Control Character 00**: Characters from 00 to 0x1F are sent as control character Ctrl+Keys, special keys are located from 0x80 to 0xA1.

**Control Character 01**: Characters from 00 to 0x1F are sent as control character Ctrl+Capital Key, special keys are located from 0x80 to 0xA1.

**Control Character 02**: Special keys are located from 00 to 0x1F and characters from 0x80 to 0xFE are intended as an extended ASCII table (Microsoft Windows Codepage 1252 — see [page 302](#)).

### Single Press and Release Keys

In the following tables, Ar↓ means Alt right pressed and Ar↑ means Alt right released and so on. Definitions for other keys are Al (Alt left ), Cr (Control Right ) Cl (Control Left ) Sh (shift). This method can be used for combining Alt, Control or Shift with other keys.

Example: Consider a Control character set to 00. If AltRight+A is required before sending a label to the host, it could be done by setting three Prefix keys in this way: 0x99 0x41 0x9A.

# Interface Type PC AT PS/2 or USB-Keybaord

Table 23. Scancode Set When Control Character is 00 or 01

	x0	x1	x2	x3	x4	x5	X6	x7	x8	x9	xA	xB	xC	xD	xE	xF
0x	NULL C+@	SOH C(S)+A	STX C(S)+B	ETX C(S)+C	EOT C(S)+D	ENQ C(S)+E	ACK C(S)+F	BEL C(S)+G	BS	HT TAB	LF C(S)+J	VT C(S)+K	FF C(S)+L	CR Enter	SO C(S)+N	SI C(S)+O
1x	DLE C(S)+P	DC1 C(S)+Q	DC2 C(S)+R	DC3 C(S)+S	DC4 C(S)+T	NAK C(S)+U	SYN C(S)+V	ETB C(S)+W	CAN C(S)+X	EM C(S)+Y	SUB C(S)+Z	ESC Esc	FS C+I	GS C+J	RS C+^	US C(S)+_
2x	SP	!	"	#	\$	%	&	'	(	)	*	+	,	-	.	/
3x	0	1	2	3	4	5	6	7	8	9	:	;	<	=	>	?
4x	@	A	B	C	D	E	F	G	H	I	J	K	L	M	N	O
5x	P	Q	R	S	T	U	V	W	X	Y	Z	[	\	]	^	_
6x	`	a	b	c	d	e	f	g	h	i	j	k	l	m	n	o
7x	p	q	r	s	t	u	v	w	x	y	z	{		}	~	Del
8x	€	Sh↓	Sh↑	Ins	Ent (keyp)	F1	F2	F3	F4	F5	F6	F7	F8	F9	F10	F11
9x	F12	Home	End	Pg Up	Pg Dwn	↑	↓	←	→	Ar↓	Ar↑	Al↓	Al↑	Cl↓	Cl↑	Cr↓
Ax	Cr↑		‘	f	„	…	†	‡	^	‰	Š	◀	Š	◀	Œ	
Bx	°	±	²	³	´	µ	¶	·	,	‘	°	»	¼	½	¾	¿
Cx	À	Á	Â	Ã	Ä	Å	Æ	Ç	È	É	Ê	Ë	Ì	Í	Î	Ï
Dx	Ð		Ò	Ó	Ô	Õ	Ö	×	Ø	Ù	Ú	Û	Ü	Ý	Þ	ß
Ex	à	á	â	ã	ä	å	æ	ç	è	é	ê	ë	ì	í	î	ï
Fx	ð	ñ	ò	ó	ô	õ	ö	÷	ø	ù	ú	û	ü	ý	þ	ÿ

Extended characters (sky blue) are sent through dedicated keys (when available in the selected country mode) or by using an Alt Mode sequence.

## Interface Type PC AT PS/2 or USB-Keyboard (continued)

Table 24. Scancode Set When Control Character is 02

	x0	x1	x2	x3	x4	x5	X6	x7	x8	x9	xA	xB	xC	xD	xE	xF
0x	Ar↓	Ar↑	Al↓	Al↑	Cl↓	Cl↑	Cr↓	Cr↑	BS	Tab	→	S+ Tab	Enter Keyprd	Enter	Ins	Pg Up
1x	Pg Dwn	Home	←	↓	↑	F6	F1	F2	F3	F4	F5	ESC	F7	F8	F9	F10
2x	Space	!	“	#	\$	%	&	‘	(	)	*	+	,	-	.	/
3x	0	1	2	3	4	5	6	7	8	9	:	;	<	=	>	?
4x	@	A	B	C	D	E	F	G	H	I	J	K	L	M	N	O
5x	P	Q	R	S	T	U	V	W	X	Y	Z	[	\	]	^	_
6x	`	a	b	c	d	e	f	g	h	i	j	k	l	m	n	o
7x	p	q	r	s	t	u	v	w	x	y	z	{		}	~	Del
8x	€		‘	f	„	…	†	‡	^	%	Š	<	Š	<	Œ	
9x		‘	’	“	”	•	–	—	~	™	š	>	œ		ž	ÿ
Ax	NBSP	ı	¢	£	¤	¥	¦	§	¨	©	ª	«	¬	-	®	¯
Bx	°	±	²	³	´	µ	¶	·	,	ı	°	»	¼	½	¾	¿
Cx	À	Á	Â	Ã	Ä	Å	Æ	Ç	È	É	Ê	Ë	Ì	Í	Î	Ï
Dx	Ð		Ò	Ó	Ô	Õ	Ö	×	Ø	Ù	Ú	Û	Ü	Ý	Þ	ß
Ex	à	á	â	ã	ä	å	æ	ç	è	é	ê	ë	ì	í	î	ï
Fx	ð	ñ	ò	ó	ô	õ	ö	÷	ø	ù	ú	û	ü	ý	þ	ÿ

# Interface Type PC AT PS/2 Alt Mode or USB-Keyboard Alt Mode

Table 25. Scancode Set When Control Character is 00 or 01

	x0	x1	x2	x3	x4	x5	X6	x7	x8	x9	xA	xB	xC	xD	xE	Xf
0x	Alt+000	Alt+001	Alt+002	Alt+003	Alt+004	Alt+005	Alt+006	Alt+007	BS	HT TAB	Alt+010	Alt+011	Alt+012	CR Enter	Alt+014	Alt+015
1x	Alt+016	Alt+017	Alt+018	Alt+019	Alt+020	Alt+021	Alt+022	Alt+023	Alt+024	Alt+025	Alt+026	ESC Esc	Alt+028	Alt+029	Alt+030	Alt+031
2x	A+032	A+033	A+034	A+035	A+036	A+037	A+038	A+039	A+040	A+041	A+042	A+043	A+044	A+045	A+046	A+047
3x	A+048	A+049	A+050	A+051	A+052	A+053	A+054	A+055	A+056	A+057	A+058	A+059	A+060	A+061	A+062	A+063
4x	A+064	A+065	A+066	A+067	A+068	A+069	A+070	A+071	A+072	A+073	A+074	A+075	A+076	A+077	A+078	A+079
5x	A+080	A+081	A+082	A+083	A+084	A+085	A+086	A+087	A+088	A+089	A+090	A+091	A+092	A+093	A+094	A+095
6x	A+096	A+097	A+098	A+099	A+100	A+101	A+102	A+103	A+104	A+105	A+106	A+107	A+108	A+109	A+110	A+111
7x	A+112	A+113	A+114	A+115	A+116	A+117	A+118	A+119	A+120	A+121	A+122	A+123	A+124	A+125	A+126	A+127
8x	€	Sh↓	Sh↑	Ins	Ent (keyp)	F1	F2	F3	F4	F5	F6	F7	F8	F9	F10	F11
9x	F12	Home	End	Pg Up	Pg Dwn	↑	↓	←	→	Ar↓	Ar↑	Al↓	Al↑	Cl↓	Cl↑	Cr↓
Ax	Cr↑	A+0161	A+0162	A+0163	A+0164	A+0165	A+0166	A+0167	A+0168	A+0169	A+0170	A+0171	A+0172	A+0173	A+0174	A+0175
Bx	A+0176	A+0177	A+0178	A+0179	A+0180	A+0181	A+0182	A+0183	A+0184	A+0185	A+0186	A+0187	A+0188	A+0189	A+0190	A+0191
Cx	A+0192	A+0193	A+0194	A+0195	A+0196	A+0197	A+0198	A+0199	A+0200	A+0201	A+0202	A+0203	A+0204	A+0205	A+0206	A+0207
Dx	A+0208	A+0209	A+0210	A+0211	A+0212	A+0213	A+0214	A+0215	A+0216	A+0217	A+0218	A+0219	A+0220	A+0221	A+0222	A+0223
Ex	A+0224	A+0225	A+0226	A+0227	A+0228	A+0229	A+0230	A+0231	A+0232	A+0233	A+0234	A+0235	A+0236	A+0237	A+0238	A+0239
Fx	A+0240	A+0241	A+0242	A+0243	A+0244	A+0245	A+0246	A+0247	A+0248	A+0249	A+0250	A+0251	A+0252	A+0253	A+0254	A+0255

## Interface Type PC AT PS/2 Alt Mode or USB-Keyboard Alt Mode (continued)

Table 26. Scancode Set When Control Character is 02

	x0	x1	x2	x3	x4	x5	x6	x7	x8	x9	xA	xB	xC	xD	xE	xF
0x	Ar↓	Ar↑	Al↓	Al↑	Cl↓	Cl↑	Cr↓	Cr↑	BS	Tab	→	S+ Tab	Enter Keyprd	Enter	Ins	Pg Up
1x	Pg Dwn	Home	←	↓	↑	F6	F1	F2	F3	F4	F5	ESC	F7	F8	F9	F10
2x	A+032	A+033	A+034	A+035	A+036	A+037	A+038	A+039	A+040	A+041	A+042	A+043	A+044	A+045	A+046	A+047
3x	A+048	A+049	A+050	A+051	A+052	A+053	A+054	A+055	A+056	A+057	A+058	A+059	A+060	A+061	A+062	A+063
4x	A+064	A+065	A+066	A+067	A+068	A+069	A+070	A+071	A+072	A+073	A+074	A+075	A+076	A+077	A+078	A+079
5x	A+080	A+081	A+082	A+083	A+084	A+085	A+086	A+087	A+088	A+089	A+090	A+091	A+092	A+093	A+094	A+095
6x	A+096	A+097	A+098	A+099	A+100	A+101	A+102	A+103	A+104	A+105	A+106	A+107	A+108	A+109	A+110	A+111
7x	A+112	A+113	A+114	A+115	A+116	A+117	A+118	A+119	A+120	A+121	A+122	A+123	A+124	A+125	A+126	A+127
8x	A+0128	A+0129	A+0130	A+0131	A+0132	A+0133	A+0134	A+0135	A+0136	A+0137	A+0138	A+0139	A+0140	A+0141	A+0142	A+0143
9x	A+0144	A+0145	A+0146	A+0147	A+0148	A+0149	A+0150	A+0151	A+0152	A+0153	A+0154	A+0155	A+0156	A+0157	A+0158	A+0159
Ax	A+0160	A+0161	A+0162	A+0163	A+0164	A+0165	A+0166	A+0167	A+0168	A+0169	A+0170	A+0171	A+0172	A+0173	A+0174	A+0175
Bx	A+0176	A+0177	A+0178	A+0179	A+0180	A+0181	A+0182	A+0183	A+0184	A+0185	A+0186	A+0187	A+0188	A+0189	A+0190	A+0191
Cx	A+0192	A+0193	A+0194	A+0195	A+0196	A+0197	A+0198	A+0199	A+0200	A+0201	A+0202	A+0203	A+0204	A+0205	A+0206	A+0207
Dx	A+0208	A+0209	A+0210	A+0211	A+0212	A+0213	A+0214	A+0215	A+0216	A+0217	A+0218	A+0219	A+0220	A+0221	A+0222	A+0223
Ex	A+0224	A+0225	A+0226	A+0227	A+0228	A+0229	A+0230	A+0231	A+0232	A+0233	A+0234	A+0235	A+0236	A+0237	A+0238	A+0239
Fx	A+0240	A+0241	A+0242	A+0243	A+0244	A+0245	A+0246	A+0247	A+0248	A+0249	A+0250	A+0251	A+0252	A+0253	A+0254	A+0255

# Microsoft Windows Codepage 1252

Windows-1252 is a character encoding of the Latin alphabet, used by default in the legacy components of Microsoft Windows in English and some other Western languages.

	00	01	02	03	04	05	06	07	08	09	0A	0B	0C	0D	0E	0F
00	NUL 0000	STX 0001	SOT 0002	ETX 0003	EOT 0004	ENO 0005	ACK 0006	BEL 0007	BS 0008	HT 0009	LF 000A	VT 000B	FF 000C	CR 000D	SD 000E	SI 000F
10	DLE 0010	DC1 0011	DC2 0012	DC3 0013	DC4 0014	NAK 0015	SYN 0016	ETB 0017	CAN 0018	EM 0019	SUB 001A	ESC 001B	FS 001C	GS 001D	RS 001E	US 001F
20	SP 0020	!	"	#	\$	%	&	'	(	)	*	+	,	-	.	/
30	0	1	2	3	4	5	6	7	8	9	:	;	<	=	>	?
40	@	A	B	C	D	E	F	G	H	I	J	K	L	M	N	O
50	P	Q	R	S	T	U	V	W	X	Y	Z	[	\	]	^	_
60	`	a	b	c	d	e	f	g	h	i	j	k	l	m	n	o
70	p	q	r	s	t	u	v	w	x	y	z	{		}	~	DEL 007F
80	€ 20AC	•	ƒ 201A	„ 201E	… 2026	† 2020	‡ 2021	ˆ 02C5	‰ 2030	Š 0160	< 0162	Œ 0162	•	ž 017D	•	•
90	•	ı 2018	/	™ 201C	” 201D	• 2022	– 2013	— 2014	˜ 02DC	™ 2122	Š 0161	› 203A	œ 0163	•	ž 017E	Ÿ 0178
A0	NEST 00A0	ı 00A1	ϕ 00A2	£ 00A3	α 00A4	¥ 00A5	ı 00A6	§ 00A7	• 00A8	© 00A9	• 00AA	« 00AB	¬ 00AC	– 00AD	© 00AE	— 00AF
B0	° 00B0	± 00B1	² 00B2	³ 00B3	´ 00B4	µ 00B5	¶ 00B6	· 00B7	¸ 00B8	¹ 00B9	º 00BA	» 00BB	¼ 00BC	½ 00BD	¾ 00BE	¿ 00BF
C0	À 00C0	Á 00C1	Â 00C2	Ã 00C3	Ä 00C4	Å 00C5	Æ 00C6	Ç 00C7	È 00C8	É 00C9	Ê 00CA	Ë 00CB	Ì 00CC	Í 00CD	Î 00CE	Ï 00CF
D0	Ð 00D0	Ñ 00D1	Ò 00D2	Ó 00D3	Ô 00D4	Õ 00D5	Ö 00D6	× 00D7	Ø 00D8	Ù 00D9	Ú 00DA	Û 00DB	Ü 00DC	Ý 00DD	Þ 00DE	ß 00DF
E0	à 00E0	á 00E1	â 00E2	ã 00E3	ä 00E4	å 00E5	æ 00E6	ç 00E7	è 00E8	é 00E9	ê 00EA	ë 00EB	ì 00EC	í 00ED	î 00EE	ï 00EF
F0	ø 00F0	ñ 00F1	ò 00F2	ó 00F3	ô 00F4	õ 00F5	ö 00F6	÷ 00F7	ø 00F8	ù 00F9	ú 00FA	û 00FB	ü 00FC	ý 00FD	þ 00FE	ÿ 00FF



# Index

## Symbols

. 211, 214, 221

## B

bar codes

RS-232

    baud rate 63

RS-232 parameters

    parity 188

barcodes

cancel 295

numeric barcodes 295

RS-232 parameters

    parity 11, 222

Beeper

    Pitch, Good Read 90

    Volume, Good Read 91

Beeper, Good Read 82

## C

Conversion, case 78

Conversion, character 78, 242

Coupon Control 196, 199, 202, 205, 208, 211,  
214, 220, 221

## D

Defaults 279

## E

Expand 135

## G

Good Read, Beeper 82

    Pitch 90

    Volume 91

Good Read, Beeper – 82

Good Read, Beeper Pitch – 90

Good Read, Beeper Volume – 91

## H

Handheld Scanner 66

## I

Indications 275

## K

keyboard support 10, 36

## N

numbers lock key 59

## P

Pitch – Good Read, Beeper 90

Prefix/Suffix 68, 236

Product Specifications 271

Programming Barcodes 13

---

## R

Read, Beeper – Good 82

Read, Beeper Pitch – Good 90

Read, Beeper Volume – Good 91

## S

sample barcodes

code 128 291

code 39 291

interleaved 2 of 5 292

Scancode Tables 297

select digits/characters 295

Suffix 68, 236

Symbologies 225

symbology types 291

## T

Table Top Scanner 66

## U

UPC 107

## V

Volume – Good Read, Beeper 91



# ASCII Chart

ASCII Char.	Hex No.	ASCII Char.	Hex No.	ASCII Char.	Hex No.	ASCII Char.	Hex No.
NUL	00	SP	20	@	40	'	60
SOH	01	!	21	A	41	a	61
STX	02	"	22	B	42	b	62
ETX	03	#	23	C	43	c	63
EOT	04	\$	24	D	44	d	64
ENQ	05	%	25	E	45	e	65
ACK	06	&	26	F	46	f	66
BEL	07	'	27	G	47	g	67
BS	08	(	28	H	48	h	68
HT	09	)	29	I	49	i	69
LF	0A	*	2A	J	4A	j	6A
VT	0B	+	2B	K	4B	k	6B
FF	0C	,	2C	L	4C	l	6C
CR	0D	-	2D	M	4D	m	6D
SO	0E	.	2E	N	4E	n	6E
SI	0F	/	2F	O	4F	o	6F
DLE	10	0	30	P	50	p	70
DC1	11	1	31	Q	51	q	71
DC2	12	2	32	R	52	r	72
DC3	13	3	33	S	53	s	73
DC4	14	4	34	T	54	t	74
NAK	15	5	35	U	55	u	75
SYN	16	6	36	V	56	v	76
ETB	17	7	37	W	57	w	77
CAN	18	8	38	X	58	x	78
EM	19	9	39	Y	59	y	79
SUB	1A	:	3A	Z	5A	z	7A
ESC	1B	;	3B	[	5B	{	7B
FS	1C	<	3C	\	5C		7C
GS	1D	=	3D	]	5D	}	7D
RS	1E	>	3E	^	5E	~	7E
US	1F	?	3F	_	5F	DEL	7F



[www.datalogic.com](http://www.datalogic.com)

©2016-2018 Datalogic S.p.A. and/or its affiliates. All rights reserved.  
Datalogic and the Datalogic logo are registered trademarks of Datalogic S.p.A. in many countries, including the U.S.A. and the E.U.

**Datalogic USA Inc.**

959 Terry Street | Eugene, OR 97402 | U.S.A. |  
Telephone: (541) 683-5700 |  
Fax: (541) 345-7140



820083714

(Rev B)

April 2018