

Mounting Brackets (Order Separately)

Power rating	Mounting direction	Model
15 W	DIN Rail	S82Y-FSC015DIN
25 W		S82Y-FSC025DIN
35 W		S82Y-FSC050DIN
50 W		
75 W		S82Y-FSC150DIN
100 W		
150 W		
200 W		
350 W		
15 W		Bottom-mounting to DIN Rail
25 W	S82Y-FSC025DIN-S	
35 W	S82Y-FSC035DIN-S	
50 W	S82Y-FSC050DIN-S	
75 W	S82Y-FSC100DIN-S	
100 W		
150 W	S82Y-FSC150DIN-S	
200 W	Bottom-mounting with L-brackets	S82Y-FSC350B (4 brackets)
350 W		

S82Y-FSC015DIN

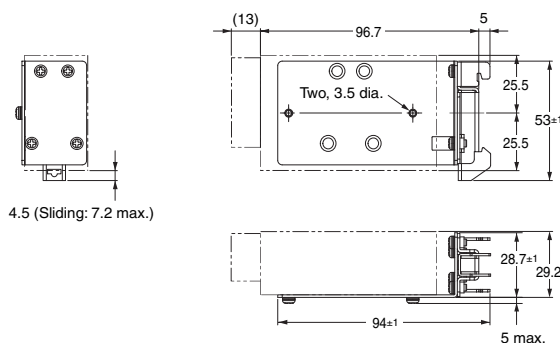
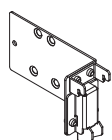

Mounting Method

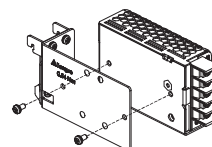

Accessories (2 locations)
 Be sure to use the accessory screws.
 Mounting screw tightening torque: 0.48 to 0.59 N·m for M3 screws

S82Y-FSC025DIN

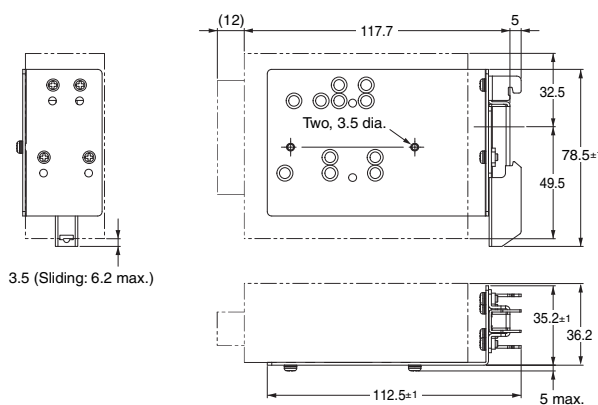
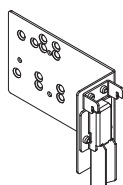

Mounting Method

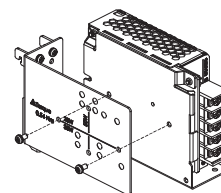

Accessories (2 locations)
 Be sure to use the accessory screws.
 Mounting screw tightening torque: 0.48 to 0.59 N·m for M3 screws

S8FS-C

S82Y-FSC050DIN

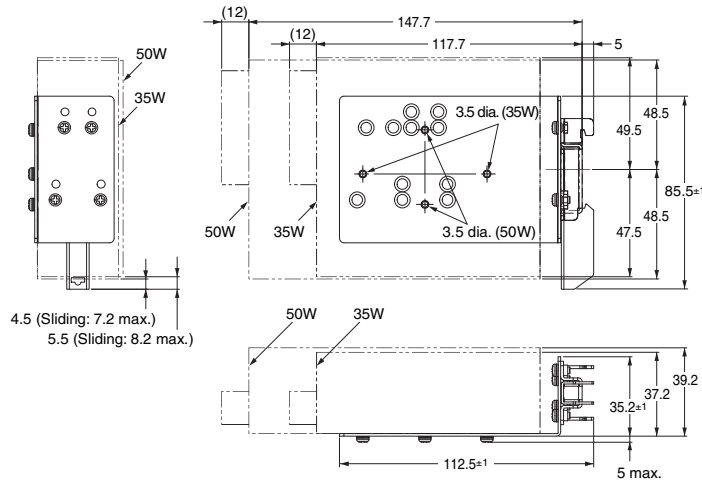
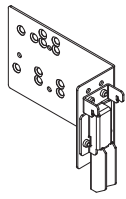

Mounting Method

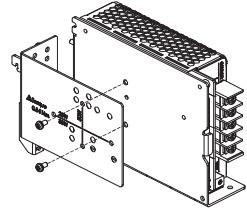

Accessories (2 locations)
 Be sure to use the accessory screws.
 Mounting screw tightening torque:
 0.48 to 0.59 N·m for M3 screws

S82Y-FSC150DIN

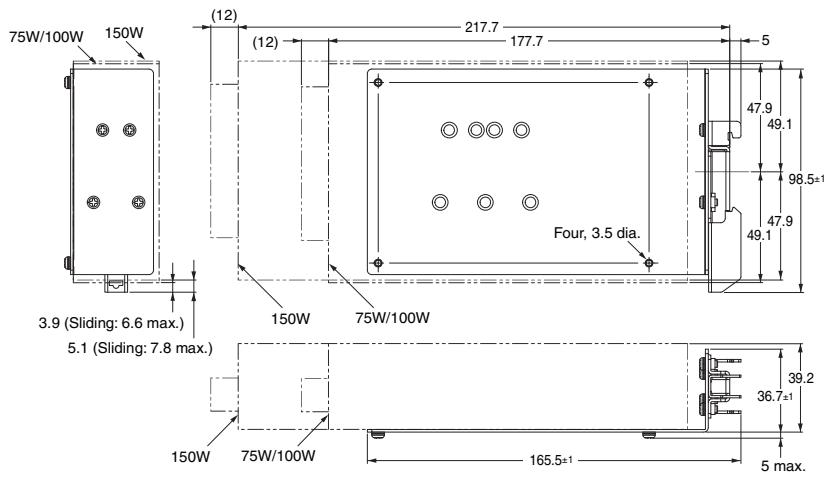
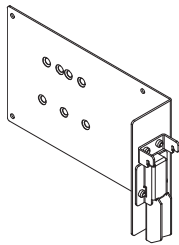

Mounting Method

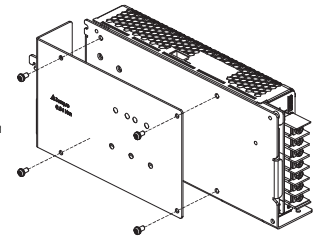

Accessories (4 locations)
 Be sure to use the accessory screws.
 Mounting screw tightening torque:
 0.48 to 0.59 N·m for M3 screws

S82Y-FSC350DIN

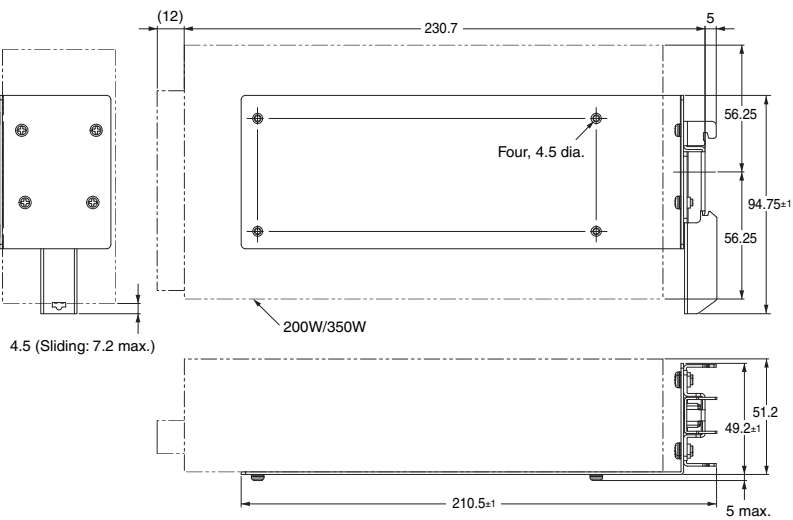
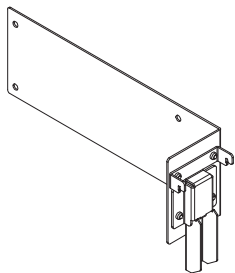

Mounting Method

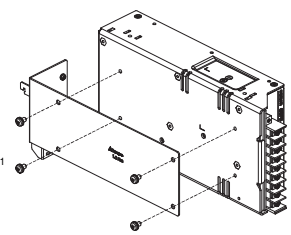

Accessories (4 locations)
 Be sure to use the accessory screws.
 Mounting screw tightening torque:
 1.08 to 1.32 N·m for M4 screws

S82Y-FSC015DIN-S

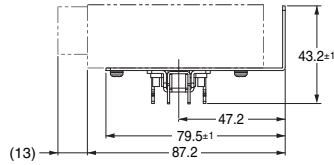
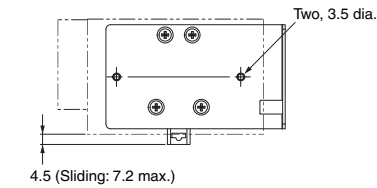
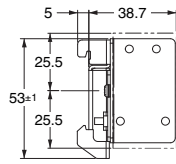
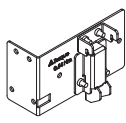

Mounting Method

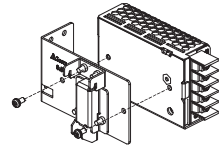

Accessories (2 locations)
 Be sure to use the accessory screws.
 Mounting screw tightening torque: 0.48 to 0.59 N-m for M3 screws

S82Y-FSC025DIN-S

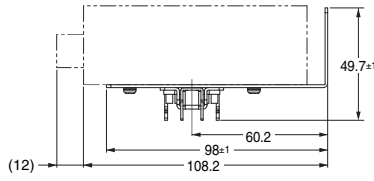
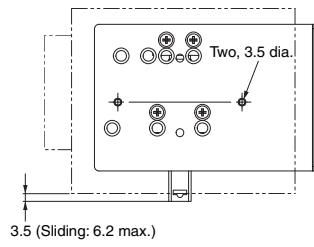
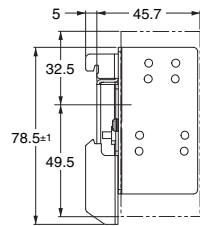
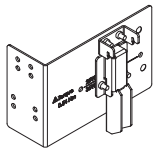

Mounting Method

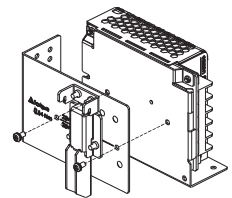

Accessories (2 locations)
 Be sure to use the accessory screws.
 Mounting screw tightening torque: 0.48 to 0.59 N-m for M3 screws

S82Y-FSC035DIN-S

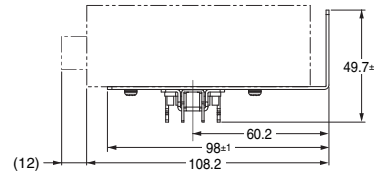
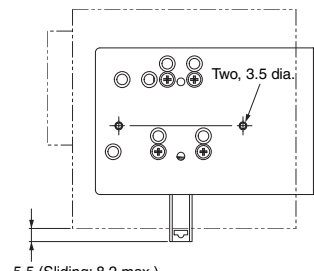
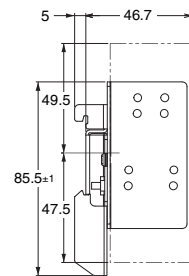
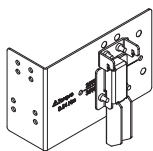

Mounting Method

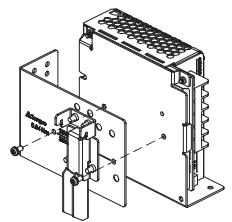

Accessories (2 locations)
 Be sure to use the accessory screws.
 Mounting screw tightening torque: 0.48 to 0.59 N-m for M3 screws

S8FS-C

S82Y-FSC050DIN-S

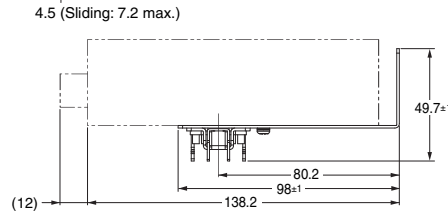
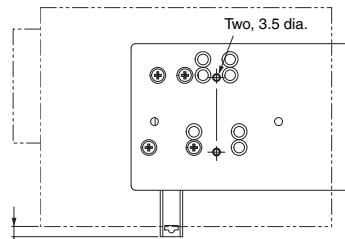
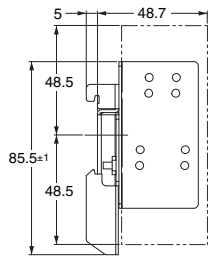
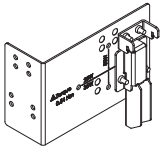

Mounting Method

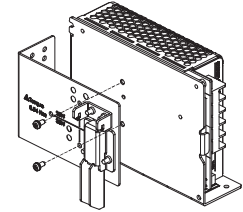

Accessories (2 locations)
 Be sure to use the accessory screws.
 Mounting screw tightening torque:
 0.48 to 0.59 N-m for M3 screws

S82Y-FSC100DIN-S

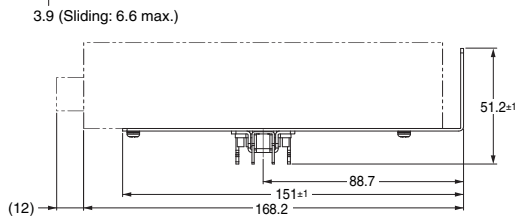
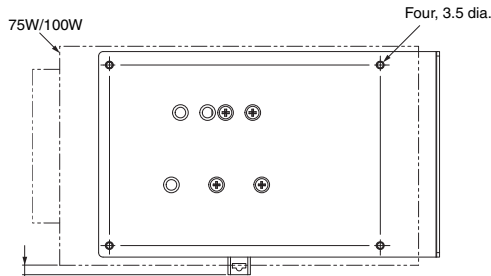
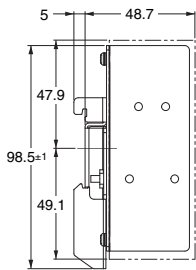
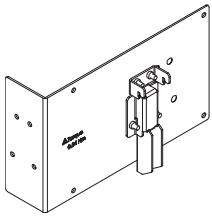

Mounting Method

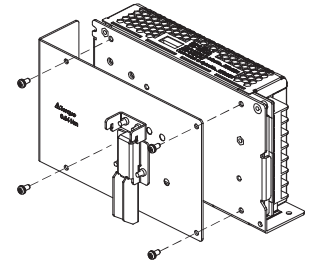

Accessories (4 locations)
 Be sure to use the accessory screws.
 Mounting screw tightening torque: 0.48
 to 0.59 N-m for M3 screws

S82Y-FSC150DIN-S

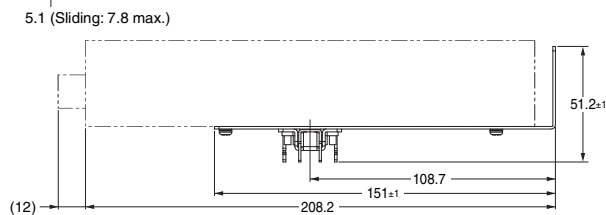
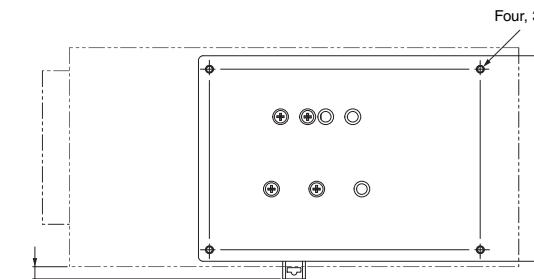
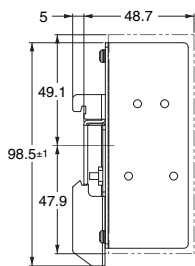
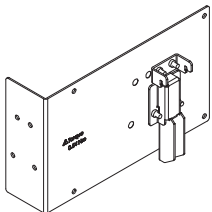

Mounting Method

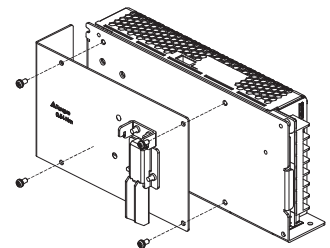

Accessories (4 locations)
 Be sure to use the accessory
 screws.
 Mounting screw tightening torque:
 0.48 to 0.59 N-m for M3 screws

S82Y-FSC350B (Four Brackets)

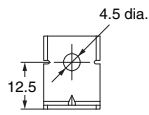
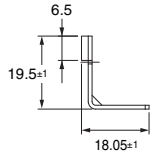
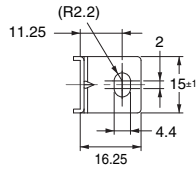
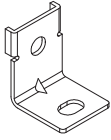

Mounting Method

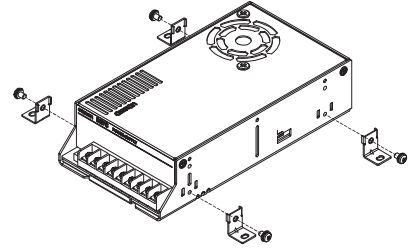

Accessories (4 locations)

Be sure to use the accessory screws.
Mounting screw tightening torque: 1.08 to 1.32 N·m for M4 screws

Note: The mounting bracket is available in 200-W and 350-W models.
The figure shows a 350-W Power Supply.

Panel mounting hole dimensions

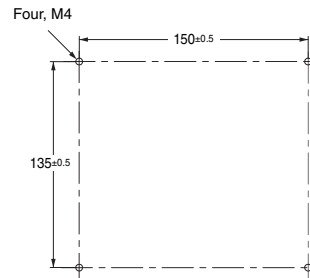
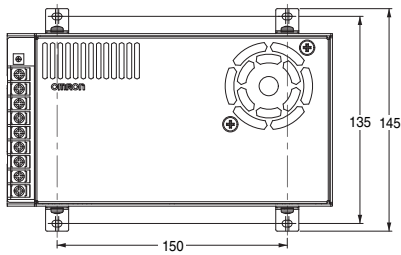

For Users of S8JC DIN Rail-mounting Power Supplies

If you are using a DIN Rail-mounting S8JC-series Power Supply, you can use a DIN Rail-mounting S8FS-C-series Power Supply or replace it with an S8FS-C-series Power Supply with a Forward-facing Terminal Block and a DIN Rail Mounting Bracket.

Table of Corresponding S8JC Power Supplies and S8FS-C□J Power Supplies with DIN Rail Mounting Brackets

Power rating	S8JC-Z *2	S8JC-ZS		S8FS-C Power Supply		DIN Rail-mounting Bracket *1
15 W	S8JC-Z01505CD	S8JC-ZS01505CD-AC2	⇒	S8FS-C01505J	+	S82Y-FSC015DIN
	S8JC-Z01512CD	S8JC-ZS01512CD-AC2	⇒	S8FS-C01512J		
	S8JC-Z01524CD	S8JC-ZS01524CD-AC2	⇒	S8FS-C01524J		
35 W	S8JC-Z03505CD	S8JC-ZS03505CD-AC2	⇒	S8FS-C03505J	+	S82Y-FSC050DIN
	S8JC-Z03512CD	S8JC-ZS03512CD-AC2	⇒	S8FS-C03512J		
	S8JC-Z03524CD	S8JC-ZS03524CD-AC2	⇒	S8FS-C03524J		
50 W	S8JC-Z05005CD	S8JC-ZS05005CD-AC2	⇒	S8FS-C05005J	+	S82Y-FSC050DIN
	S8JC-Z05012CD	S8JC-ZS05012CD-AC2	⇒	S8FS-C05012J		
	S8JC-Z05024CD	S8JC-ZS05024CD-AC2	⇒	S8FS-C05024J		
	S8JC-Z05048CD	---	⇒	S8FS-C05048J		
100 W	S8JC-Z10005CD	S8JC-ZS10005CD-AC2	⇒	S8FS-C10005J	+	S82Y-FSC150DIN
	S8JC-Z10012CD	S8JC-ZS10012CD-AC2	⇒	S8FS-C10012J		
	S8JC-Z10024CD	S8JC-ZS10024CD-AC2	⇒	S8FS-C10024J		
	S8JC-Z10048CD	---	⇒	S8FS-C10048J		
150 W	S8JC-Z15005CD	S8JC-ZS15005CD-AC2	⇒	S8FS-C15005J	+	S82Y-FSC150DIN
	S8JC-Z15012CD	S8JC-ZS15012CD-AC2	⇒	S8FS-C15012J		
	S8JC-Z15024CD	S8JC-ZS15024CD-AC2	⇒	S8FS-C15024J		
	S8JC-Z15048CD	---	⇒	S8FS-C15048J		
350 W	S8JC-Z35005CD	S8JC-ZS35005CD-AC2	⇒	S8FS-C35005J	+	S82Y-FSC350DIN
	S8JC-Z35012CD	S8JC-ZS35012CD-AC2	⇒	S8FS-C35012J		
	S8JC-Z35024CD	S8JC-ZS35024CD-AC2	⇒	S8FS-C35024J		

*1. To mount an S8FS-series Power Supply that is not a DIN Rail-mounting model to a DIN Rail, purchase a DIN Rail-mounting Bracket separately from the Power Supply.

*2. Consult with your OMRON representative if you use a 15-W or 35-W S8JC-Z Power Supply with a 48-V output voltage.

DIN Rail (Order Separately)

Note: All units are in millimeters unless otherwise indicated.

Mounting Rail (Material: Aluminum)

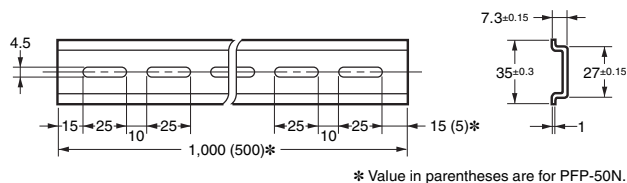
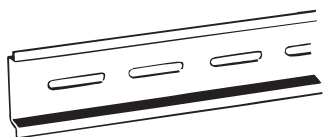

Model
PFP-100N
PFP-50N

Mounting Rail (Material: Aluminum)

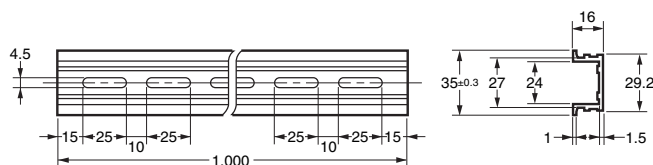
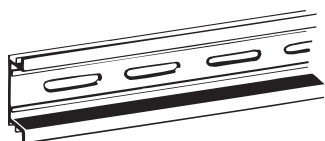

Model
PFP-100N2

End Plate

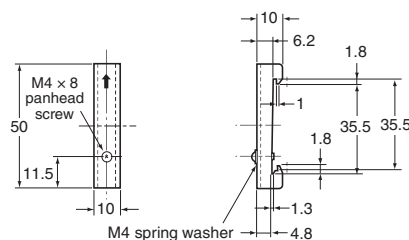

Model
PFP-M

- Note: 1. If there is a possibility that the Power Supply will be subject to vibration or shock, use a steel DIN Rail. Otherwise, metallic filings may result from aluminum abrasion.
2. If there is a possibility of the Power Supply sliding sideways, place an End Plate (PFP-M) on each end of the Power Supply.

Terminal Cover (Order Separately)

Terminal block direction	Power rating	Applicable models	Terminal Cover model number	
Models with terminal block facing upward	25-W	S8FS-C025□□	S82Y-FSC-C5	
	35-W	S8FS-C035□□		
	50-W	S8FS-C050□□		
	75-W	S8FS-C075□□		
	Models with terminal block facing forward	100-W	S8FS-C100□□	S82Y-FSC-C7
		150-W	S8FS-C150□□	S82Y-FSC-C9
		200-W	S8FS-C200□□	
		350-W	S8FS-C350□□	S82Y-FSC-C5MF
15-W		S8FS-C015□□J/D		
25-W		S8FS-C025□□J/D		
35-W		S8FS-C035□□J/D	S82Y-FSC-C5F	
50-W		S8FS-C050□□J/D		
75-W	S8FS-C075□□J/D	S82Y-FSC-C7F		
100-W	S8FS-C100□□J/D			
150-W	S8FS-C150□□J/D	S82Y-FSC-C9F		
200-W	S8FS-C200□□J/D			
350-W	S8FS-C350□□J/D			





Safety Precautions

Refer to Safety Precautions for All Power Supplies.

Warning Indications

 CAUTION	Indicates a potentially hazardous situation which, if not avoided, may result in minor or moderate injury or in property damage.
Precautions for Safe Use	Supplementary comments on what to do or avoid doing, to use the product safely.
Precautions for Correct Use	Supplementary comments on what to do or avoid doing, to prevent failure to operate, malfunction or undesirable effect on product performance.

Meaning of Product Safety Symbols

	Indicates the possibility of electric shock under specific conditions.
	Indicates the possibility of injuries by high temperature under specific conditions.
	Indicates the possibility of injuries, such as electric shock by disassembling the device, prohibiting disassembly.
	Indicates the instructions of unspecified general action.

CAUTION

Minor electric shock, fire, or Product failure may occasionally occur. Do not disassemble, modify, or repair the Product or touch the interior of the Product. 

Minor burns may occasionally occur. Do not touch the Product while power is being supplied or immediately after power is turned OFF. 

Fire may occasionally occur. Tighten terminal screws to the specified torque. 
 S8FS-C015□□J: 4.25 to 5.13 lb-in (0.48 to 0.58 N·m)
 Other than S8FS-C015□□J: 6.55 to 7.78 lb-in (0.74 to 0.88 N·m)

Minor injury due to electric shock may occasionally occur. Do not touch the terminals while power is being supplied. 

Minor electric shock, fire, or Product failure may occasionally occur. Do not allow any pieces of metal or conductors or any clippings or cuttings resulting from installation work to enter the Product. 

Precautions for Safe Use

Ambient Operating and Storage Environments

- Store the Power Supply at a temperature of -40 to 85°C and a humidity of 10% to 95%.
- The internal parts may occasionally deteriorate or be damaged. Use the standard mounting method only. Do not use the Power Supply outside the derating range.
- Use the Power Supply at a humidity of 20% to 90%.
- Do not use the Power Supply in locations subject to direct sunlight.
- Do not use the Power Supply in locations where liquids, foreign matter, or corrosive gases may enter the interior of the Power Supplies.

Installation Environment

- Do not use the Power Supply in locations subject to shocks or vibrations. Install the Power Supply away from contactors and other parts and devices that are sources of vibration.
- Install the Power Supply well away from any sources of strong, high-frequency noise and surge.

Input Voltage Selector Switch

- For 100-W or higher models, the input voltage is factory-set to 200 to 240 V.
 To use an input voltage of 100 to 120 VAC, change the input voltage selector switch to the 100 to 120 VAC setting.
 To use a DC input, set the input voltage selector switch to the 200 to 240 VAC setting.
- Minor electric shock may occasionally occur. Do not operate the input voltage selector switch while power is being supplied.

Mounting

- Take adequate measures to ensure proper heat dissipation to increase the long-term reliability of the Power Supply.
- For models other than the S8FS-C350□□□, be sure to allow convection in the atmosphere around devices when mounting. Do not use the Power Supply in locations where the ambient temperature exceeds the range of the derating curve.
- For the S8FS-C350□□□: Forced air cooling with a fan is used. Do not allow the ventilation holes to be blocked. The effectiveness of cooling would be reduced.
- The internal parts may occasionally deteriorate or be damaged. Use the standard mounting method only. Do not use the Power Supply outside the derating range.
- If you mount the Power Supply by using the screw holes provided on the chassis, the screws should preferably not penetrate beyond the exterior by more than 3 mm inside the Power Supply. If you use screws that are longer than this, make sure that they do not penetrate beyond the depth given in the dimensional diagram. Use the following tightening torque.
 - 0.48 to 0.59 N·m for M3 screws
 - 1.08 to 1.32 N·m for M4 screws
- When cutting out holes for mounting, make sure that cuttings do not enter the interior of the Power Supplies.
- The internal parts may occasionally deteriorate or be damaged due to adverse heat radiation. Do not loosen the screws on the Power Supplies.

Mounting

The standard mounting pattern is shown below.

Mounting Pattern A

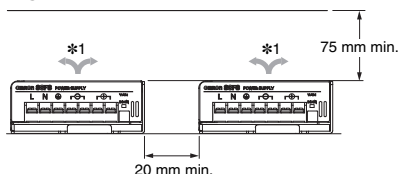

The above figure shows a model with the terminal block facing upward.

Mounting Pattern B

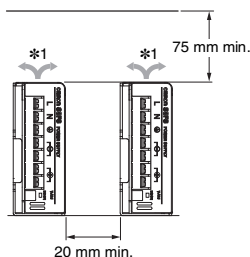

The above figure shows a model with the terminal block facing upward.

Mounting Pattern C *2

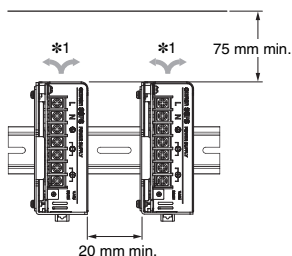

The above figure shows a model with the terminal block facing forward.

Mounting Pattern D *2

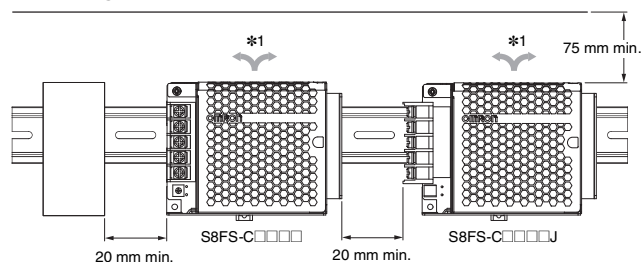

To mount the Power Supply to a DIN Rail, hook portion (A) of the Power Supply onto the DIN Rail and press the Power Supply in direction (B) until you hear it lock into place. Make sure that the catch on the Mounting Bracket is engaged with the DIN Rail.

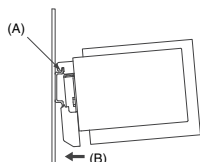

To dismount the Power Supply, pull down portion (C) with a flat-blade screwdriver and pull out the Power Supply.

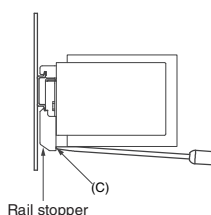

*1. Air flow

*2. For mounting patterns C and D, a separately sold Mounting Bracket is used to mount the Power Supplies to DIN Rail. Refer to *Mounting Brackets (Order Separately)* on page 29 for the separately sold Mounting Brackets.

Wiring

- Connect the ground completely. A protective earthing terminal stipulated in safety standards is used. Electric shock or malfunction may occur if the ground is not connected completely.
- Minor fire may possibly occur. Ensure that input and output terminals are wired correctly.
- Do not apply more than 75 N force to the terminal block when tightening it.
- Be sure to remove the sheet covering the Power Supply for machining before power-ON so that it does not interfere with heat dissipation.
- Use the following material for the wires to be connected to the S8FS-C to prevent smoking or ignition caused by abnormal loads.

Recommended Wire Gauges

Terminals	Model	Recommended Wire Gauges
Input	S8FS-C015□□□	AWG14 to 22
	S8FS-C025□□□ to S8FS-C100□□□	AWG12 to 20
	S8FS-C150□□□ or S8FS-C200□□□	AWG12 to 16
	S8FS-C350□□□	AWG12
Output	S8FS-C015□□□	AWG14 to 18
	S8FS-C02512 to S8FS-C02524□	AWG12 to 20
	S8FS-C03515 to S8FS-C03524□	
	S8FS-C05024 to S8FS-C05048□	
	S8FS-C02505 or S8FS-C03512□	AWG12 to 16
	S8FS-C05012 to S8FS-C05015□	
	S8FS-C07515 to S8FS-C07548□	
	S8FS-C10024 to S8FS-C10048□	
	S8FS-C15036 to S8FS-C15048□	AWG12
	S8FS-C03505 or S8FS-C05005□	
	S8FS-C07505 to S8FS-C07512□	
	S8FS-C10005 to S8FS-C10015□	
S8FS-C15005 to S8FS-C15024□		
S8FS-C200□□□ or S8FS-C350□□□		
Protective earth terminal	S8FS-C015□□□	AWG14
	S8FS-C025□□□ to S8FS-C350□□□	AWG12 to 14

Note: The current capacity for the output terminals on the S8FS-C025□□□ to S8FS-C350□□□ is 25 A for each terminal. Make sure to use multiple terminals together if the current flow is higher than the current capacity for each terminal.

Overload Protection

- If the Power Supply has been short-circuited or supplied with an overcurrent longer than 10 seconds, the internal parts of the Power Supply may occasionally deteriorate or be damaged.
- Internal parts may possibly deteriorate or be damaged if the Power Supply is used for applications with frequent inrush current or overloading at the load end. Do not use the Power Supply for such applications.

Output Voltage Adjuster (V. ADJ)

- The output voltage adjuster (V. ADJ) may possibly be damaged if it is turned with unnecessary force. Do not turn the adjuster with excessive force.
- After completing output voltage adjustment, be sure that the output capacity or output current does not exceed the rated output capacity or rated output current.

Series Operation

Two Power Supplies can be connected in series.

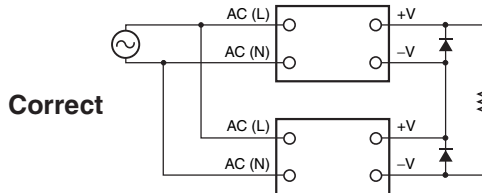

Correct

Note: 1. If the load is short-circuited, a reverse voltage will be generated inside the Power Supply. If this occurs the Power Supply may possibly deteriorate or be damaged. Always connect a diode as shown in the figure. Select a diode having the following ratings.

Type	Schottky Barrier diode
Dielectric strength (V_{RRM})	Twice the rated output voltage or above
Forward current (I_F)	Twice the rated output current or above

2. Although Power Supplies having different specifications can be connected in series, the current flowing through the load must not exceed the smaller rated output current.

Making Positive/Negative Outputs

- The outputs are floating outputs (i.e., the primary circuits and secondary circuits are separated). You can therefore make positive and negative outputs by using two Power Supplies. You can make positive and negative outputs with any of the models. If positive and negative outputs are used, connect Power Supplies of the same model as shown in the following figure. (Combinations with different output capacities or output voltages can be made. However, use the lower of the two maximum rated output currents as the current to the loads.)

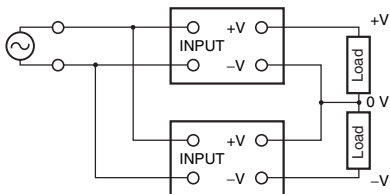

- Depending on the model, internal circuits may be damaged due to startup failure when the power is turned ON if loads such as a servomotor or operational amplifier operate in series. Therefore, connect bypass diodes (D_1 , D_2) as shown in the following figure.

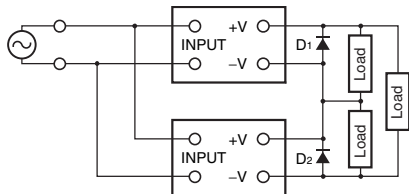

- Select a diode having the following ratings.

Type	Schottky Barrier diode
Dielectric strength (V_{RRM})	Twice the rated output voltage or above
Forward current (I_F)	Twice the rated output current or above

Parallel Operation

Parallel operation is not possible.

Parallel Operation

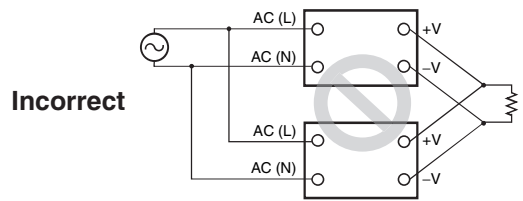

Incorrect

Backup Operation

Backup operation is possible if you use two Power Supplies of the same model.

Connect diodes as shown in the following figure for backup operation.

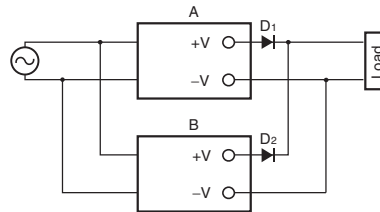

Select a diode having the following ratings.

Type	Schottky Barrier diode
Dielectric strength (V_{RRM})	Twice the rated output voltage or above
Forward current (I_F)	Twice the rated output current or above

- The output voltages of Power Supplies A and B output must be set higher only by a value equivalent to the drop in forward voltages (V_F) of diodes D_1 and D_2 .
- Power loss occurs equivalent to the Power Supply output current (I_{OUT}) times the diode forward voltage (V_F), and heat is generated. The diode must be cooled to ensure that its temperature is kept at or below the value indicated in the diode catalog.
- There will be a power loss caused by load power and diodes. Be sure that this total power loss does not exceed the rated output power (rated output voltage times rated output current) of each Power Supply.

In Case There Is No Output Voltage

There is a possibility that functions such as overcurrent protection, over-voltage protection or overheating protection are functioning. The internal protection circuit may operate if a large amount of surge voltage such as a lightning surge occurs while turning ON the Power Supply.

In case there is no output voltage, please check the following points before contacting us:

- Checking overload protection status:
 - Check whether the load is in overload status or is short-circuited. Remove wires to load when checking.
- Checking overvoltage or internal protection:
 - Turn the power supply OFF once, and leave it OFF for at least 3 minutes. Then turn it ON again to see if this clears the condition.
- Check overheating protection (350-W model):
 - Switch off the input power supply and switch back on after allowing sufficient time for cooling.

Charging Batteries

If you connect a battery at the load, install overcurrent control and overvoltage protection circuits.

Period and Terms of Warranty

Warranty Period

The Power Supply warranty is valid for a period of three years from the date of shipment from the factory.

Terms of Warranty

The warranty is valid only for the following operating conditions.

1. Average ambient operating temperature of the Power Supply: 40°C max.
2. Average load rate: 80% max.
3. Mounting method: Standard mounting

* The maximum ratings must be within the derating curve.

If the Power Supply fails for reasons attributable to OMRON within the above warranty period, OMRON will repair or replace the faulty part of the Power Supply at the place of purchase or the place where the Power Supply delivered without charge.

This warranty does not cover the following types of failures.

- (1) Failures that result from handling or operation of the Power Supply under conditions or in environments that are not given in this document and not given in any other specifications exchanged between OMRON and the customer
 - (2) Failures that originate in causes other than the delivered product itself
 - (3) Failures caused by disassembly, modification, or repair of the Power Supply by anyone other than OMRON
 - (4) Failures caused by applications or uses for which the Power Supply was not originally intended
 - (5) Failures caused by factors that could not be anticipated with the scientific or technical knowledge available when the Power Supply was shipped
 - (6) Failures caused by other causes for which OMRON is not responsible, such as natural disasters and other acts of God
- This warranty is limited to the individual product that was delivered and does not cover any secondary, subsequent, or related damages.

Recommended Replacement Periods and Periodic Replacement for Preventive Maintenance

The recommended replacement period for preventive maintenance is greatly influenced by the application environment of the Power Supply. As a guideline, the recommended replacement period is 7 to 10 years.* To prevent failures and accidents that can be caused by using a Power Supply beyond its service life, we recommend that you replace the Power Supply as early as possible within the recommended replacement period. However, bear in mind that the recommended replacement period is for reference only and does not guarantee the life of the Power Supply.

Many electronic components are used in the Power Supply and the Power Supply depends on the correct operation of these components to achieve the original Power Supply functions and performance. However, the influence of the ambient temperature on aluminum electrolytic capacitors is large, and the service life is reduced by half for each 10°C rise in temperature (Arrhenius law). When the capacity reduction life of the electrolytic capacitor is reached, Power Supply failures or accidents may occur. We therefore recommend that you replace the Power Supply periodically to minimize Power Supply failures and accidents in advance.

* The recommended replacement period applies under the following conditions: rated input voltage, load rate of 50% max., ambient temperature of 40°C max., and the standard mounting method. (The fan is excluded for models with fans.)

This product model is designed with a service life of 10 years minimum under the above conditions.