

Ø22/25 mm Round Mount Emergency Stop Switches



SF2ER Series PRODUCT MANUAL

For your safety, read and follow the considerations written in the instruction manual, other manuals and Autonics website.

The specifications, dimensions, etc. are subject to change without notice for product improvement. Some models may be discontinued without notice.

Main Features

- Easy mounting and removing of Contact Units using a lever
- Adoptable maximum three contact units in series to improve wiring efficiency
- Available to install using either round or forked crimp terminals
- Oil resistant to IP65 protection structure
- Circuit interruption function with a direct opening mechanism for the occurrence of error such as contact weld
- Supplying a various kind of accessories for improving usability
 - Ø22/25mm guard ring for emergency stop switches
 - Ø22/25mm name plate for emergency stop switches
 - Ø22/25mm contact block for emergency stop switches

Safety Considerations

- Observe all 'Safety Considerations' for safe and proper operation to avoid hazards.
- ⚠ symbol indicates caution due to special circumstances in which hazards may occur.

⚠ Warning Failure to follow instructions may result in serious injury or death.

- 01. Fail-safe device must be installed when using the unit with machinery that may cause serious injury or substantial economic loss. (e.g. nuclear power control, medical equipment, ships, vehicles, railways, aircraft, combustion apparatus, safety equipment, crime/disaster prevention devices, etc.)**
Failure to follow this instruction may result in personal injury, economic loss or fire.
 - 02. System manager means followings;**
 - a personnel who is fully aware of installation, setting, operation, and maintenance of the product
 - a personnel who well observes standard/regulation/statute on the product by type of machine the product installed in and nation/region the product used in

Machine user means a personnel who is appropriately trained about using machine by the system manager, so that machine user can operate the machine correctly. System manager has duty to train the machine user about operation of the product. Machine user has to report directly to the system manager when unusual status has been found while system is operating.

Failure to follow this instruction may result in personal injury, economic loss or fire.
- 03. The product has to be installed, set, and combined with machine control system by the qualified system manager.**
Failure to follow this instruction may result in personal injury due to unintended operation and unstable detection.
 - 04. Before using the product, check that function of the product operates as intended while machine is turned off after installation.**
Failure to follow this instruction may result in personal injury due to unintended operation and unstable detection.
 - 05. Do not use the unit in the place where flammable/explosive/corrosive gas, high humidity, direct sunlight, radiant heat, vibration, impact, salinity, moisture, steam or dust may be present.**
Failure to follow this instruction may result in explosion or fire.
 - 06. Do not disassemble or modify the unit.**
Failure to follow this instruction may result in personal injury or fire due to loss of safety function.
 - 07. Do not defeat, tamper, modify, the switch.**
Failure to follow this instruction may result in personal injury.
 - 08. Check the installed status of the switch, operating status of the switch, and signs of damage, modification, tampering of the switch at the following situation and on a weekly basis.**
 - when operating the safety system at first
 - when replacing component of the system
 - when the system has not been operated for a long time

Failure to follow this instruction may result in personal injury due to malfunction of the product and safety function.
 - 09. Do not connect, repair, inspect, or replace the unit while connected to a power source.**
Failure to follow this instruction may result in fire.
 - 10. Check 'Connections' before wiring.**
Failure to follow this instruction may result in fire.
 - 11. Normally Open (NO) Contacts cannot be used for emergency stop control circuits.**
 - 12. Keep away from high voltage lines or power lines to prevent surge and inductive noise, and make cable as short as possible.**
In case installing power line and input signal line closely, use line filter or varistor at power line and shielded wire at input signal line.
Do not use near the equipment which generates strong magnetic force or high frequency noise.
Failure to follow this instruction may result in personal injury due to malfunction of the product and safety function.

⚠ Caution Failure to follow instructions may result in injury or product damage.

- 01. Use the unit within the rated specifications.**
Failure to follow this instruction may result in fire or product damage.
- 02. Use a dry cloth to clean the unit, and do not use water or organic solvent.**
Failure to follow this instruction may result in fire.
- 03. Keep the product away from metal chip, dust, and wire residue which flow into the unit.**
Failure to follow this instruction may result in fire, product damage or malfunction.

Cautions during Use

- Follow instructions in 'Cautions during Use'. Otherwise, it may cause unexpected accidents.
- Emergency stop pushbuttons are UL NISD Listed when mounted in a sealed, non-ventilated enclosure only.
- When installing the product, keep the minimum installation space between units.
- The switch must be properly assembled.
- While wiring or after wiring the contact block, do not pull the cable.
- Do not hit or flip the button, and use hand not any tool to push the button
- To unlock the switch, turn the button approximately 45° clockwise, and do not turn the button with excessive force.
- This unit may be used in the following environments.
 - Indoors (UL Type 1 Enclosur)
 - Altitude max. 2,000m
 - Pollution degree 3
 - Installation category III

Ordering Information

This is only for reference, the actual product does not support all combinations. For selecting the specified model, follow the Autonics website.

SF2ER - E ① R ② - ③

① Button

- 1: D30 (short head, non-illuminated)
- 2: D40 (short head, non-illuminated)

③ Mark

- No-mark: No-mark
- A: EMO
- S: EMS

② Contact block

- B: B contact: 1
- AB: A contact: 1, B contact: 1
- 2B: B contact: 2
- A2B: A contact: 1, B contact: 2
- 3B: B contact: 3

Sold Separately

- Protection guard ring
- Name plate
- Protection guard ring + Name plate set
- Radial support rubber packing / Radial support
- Contact block

Specifications

Model	SF2ER-□□□□-□
Rated voltage/current	IEC: AC-15 (220 VAC~, 3 A), DC-13 (220 VDC≐, 0.2 A) UL: A300, Q300
Contact operating power	3.0 to 8.0 N/ 1 contact
Operation distance	5.0 mm (0/-0.5)
Rotation angle	CW (clock wise) 52 °
Allowable operation frequency ⁰¹⁾	Mechanical: 20 times/minute, electrical: 20 times/minute
Life cycle	Mechanical: ≥ 250,000 times, electrical: ≥ 100,000 times
Applicable wire	AWG 18 (0.823 mm ²)
Insulation resistance	≥ 100 MΩ (500 VDC≐ megger)
Dielectric strength	2,500 VAC~ 50/60 Hz for 1 minute
Vibration	1.5 mm double amplitude at frequency of 10 to 55 Hz (for 1 min) in each X, Y, Z direction for 2 hours
Vibration (malfunction)	1.5 mm double amplitude at frequency of 10 to 55 Hz (for 1 min) in each X, Y, Z direction for 10 minutes
Shock	1,000 m/s ² (≈ 100 g) in each X, Y, Z direction for 3 times
Shock (malfunction)	250 m/s ² (≈ 25 g) in each X, Y, Z direction for 3 times
Ambient temperature	-20 to 65°C ⁰²⁾ , storage: -40 to 70 °C (at no freezing or condensation)
Ambient humidity	35 to 85 %RH, storage: 35 to 85 %RH (at no freezing or condensation)
Protection structure	IP65 ⁰³⁾ (oil resistant, IEC standards)
Material	Button: PC, body: PA6, lever in fixing unit: PA6
Approval	CE, UL, IEC, VDE, S, etc.
Weight ⁰⁴⁾	≈ 66g

01) Setting and resetting once is counted as one operation.

02) UL approved ambient temperature: 55 °C

03) It is only for part from front of the panel. Protection structure is guaranteed only when the switch is installed on flat and smooth surface with mounting holes Ø22mm.

04) It is switch with three contact blocks.

Contact capacity

IEC (EN60947-5-1)

Rated current		10 A			
Rated voltage		24 V	110 V	220 V	380 V
AC	Resistive load (AC-12)	10 A	10 A	6 A	3 A
	Inductive load (AC-15)	10 A	5 A	3 A	2 A
DC	Resistive load (DC-12)	10 A	2 A	0.6 A	0.2 A
	Inductive load (DC-13)	1.5 A	0.5 A	0.2 A	0.1 A

UL / CSA (UL508, CSA C22.2 No. 14)

A300

Rated voltage	Through current	Current (A)		Volt ampere (VA)	
		Making	Breaking	Making	Breaking
AC120 V	10 A	60	6	7,200	720
AC240 V		30	3		

Q300

Rated voltage	Through current	Current (A)		Volt ampere (VA)	
		Making	Breaking	Making	Breaking
DC125 V	2.5 A	0.55	0.55	69	69
DC250 V		0.27	0.27		

Dimensions

- Unit: mm, For the detailed drawings, follow the Autonics website.
- Drawings show the no-mark model.

D30 (short head, non-illuminated)

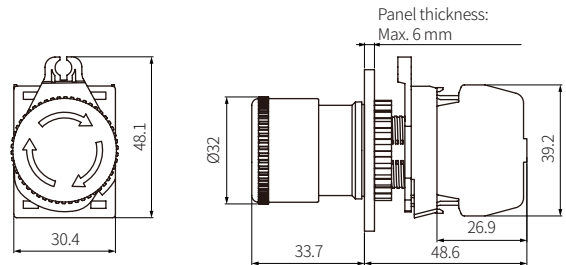

D40 (short head, non-illuminated)

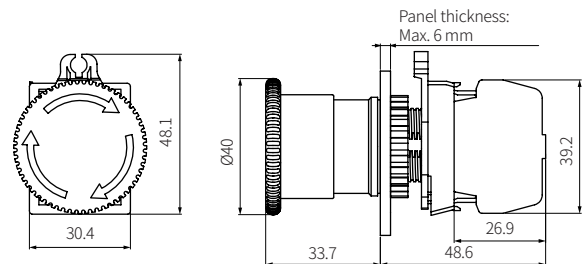

Panel cut-out

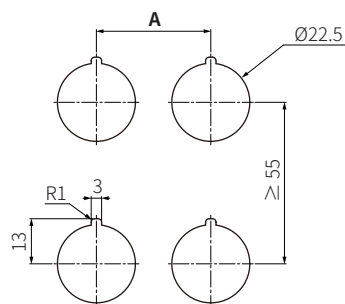

	A
D30	≥ 33 mm
D40	≥ 55 mm

Parts Descriptions

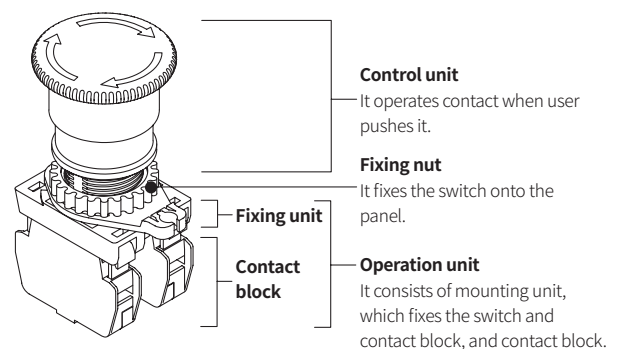

Installation and Remove

■ Installing

1. Insert the control unit from the front side of panel in the ① direction.
2. Insert the fixing nut from the rare side of panel in the ② direction.
3. Turn the fixing nut in the ③ direction to tighten.
Before tightening the fixing nut, be sure that there is rubber washer between the switch and panel.
4. Put the operation unit to the control unit in the ④ direction.

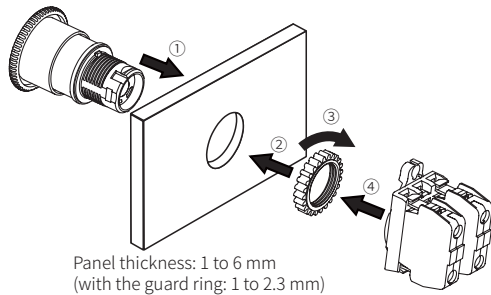

■ Removing

1. Turn the lever in the ① direction using the screwdriver.
2. Pull the operation unit in the ② direction to disassemble it.
3. Release the fixing nut in the ① direction to disassemble it.

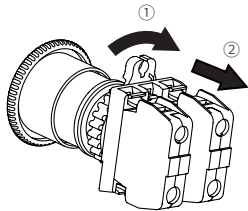

Contact block

■ Assembling contact block

Insert the contact block in the arrow direction.

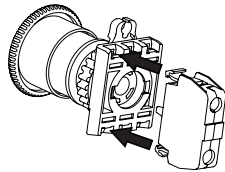

■ Disassembling contact block

Lift up the lever in the arrow direction with the screwdriver and to disassemble the contact block.

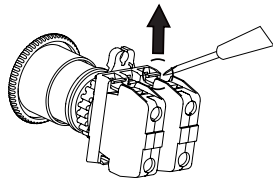

■ Wiring

- When wiring contact block, use phillips or slotted M3.5 screws with square washer.
- Applicable wire: AWG 18 (0.823 mm²)
- Tightening torque: 0.6 to 0.8 N·m
- Unit: mm, Please use UL certified terminals.

Non-insulated terminal		Insulated terminal	
Spade terminal	Ring terminal	Spade terminal	Ring terminal

Sold Separately

Guard ring

• Unit: mm, For the detailed drawings, follow the Autonics website.

Item	Appearance	Model
Standard type	<p>Color: </p> <p>● GUARD-SF2ER ○ GUARD-SF2ER-W</p>	
Circle type	<p>Color: </p> <p>● GUARD2-SF2ER ○ GUARD2-SF2ER-W</p>	
Lock type	<p>Color: </p> <p>This guard ring is sold only as protection guard ring + name plate set. (single metal latch sold separately: GUARD3-SF2ER-L)</p>	
Metal type	<p>Color: </p> <p>GUARD2-SF2ER-M</p>	
Embedded type (no spacer)	<p>Color: </p> <p>Panel thickness: 1.3 to 22.5</p> <p>GUARD4-SF2ER</p>	
Embedded type (spacer × 1)	<p>Color: </p> <p>Panel thickness: 1.3 to 12.5</p> <p>GUARD41-SF2ER</p>	
Embedded type (spacer × 2)	<p>Color: </p> <p>Panel thickness: 1.3 to 2.5</p> <p>GUARD42-SF2ER</p>	

Embedded type guard ring panel cut-out

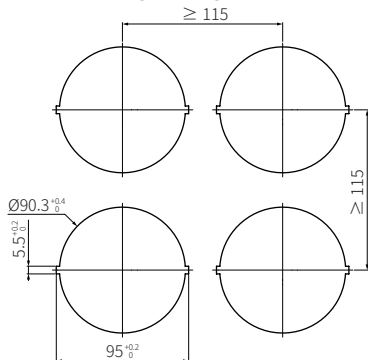

Name plate

• Unit: mm, For the detailed drawings, follow the Autonics website.

Item	Appearance	Model
Ø 90, STOP	<p>Size: D90 × d25 Thickness: 1</p>	SF2ER-B
Ø 90, OFF	<p>Size: D90 × d25 Thickness: 1</p>	SF2ER-B2
Ø 60, STOP	<p>Size: D60 × d25 Thickness: 1</p>	SF2ER-B3
Ø 60, OFF	<p>Size: D60 × d25 Thickness: 1</p>	SF2ER-B4

Guard ring + name plate set

• The thickness of the name plate included in the guard ring + name plate set is 0.5 mm.

Guard ring	Name plate	Model
Standard type	Ø 60, STOP	GUARD-SF2ER-S
	Ø 60, OFF	GUARD-SF2ER-A
Standard type white	Ø 60, STOP	GUARD-SF2ER-S-W
	Ø 60, STOP	GUARD2-SF2ER-S
Circle type	Ø 60, OFF	GUARD2-SF2ER-A
	Ø 60, STOP	GUARD2-SF2ER-S-W
Circle type white	Ø 60, STOP	GUARD2-SF2ER-S-W
	Ø 60, STOP	GUARD3-SF2ER-S
Lock type	Ø 60, OFF	GUARD3-SF2ER-A
	Ø 60, STOP	GUARD2-SF2ER-S-M
Metal type	Ø 60, OFF	GUARD2-SF2ER-A-M

Radial support

• Unit: mm, For the detailed drawings, follow the Autonics website.

Item	Appearance	Model
Rubber packing	<p>Size: Ø25</p>	BK-SF2ER-RP
Radial support	<p>Size: Ø22</p>	BK-SF2ER-P

Contact block

Item	Appearance	Model
A contact (Normally Open)		SFEA-CA
B contact (Normally Closed)		SFEA-CB