

OHTAKE

Japan Quality since 1968

Automatic Screw Feeder

自動ネジ供給機

SS Series

Operation Manual (Maintenance)

- Read these instructions for the proper use of this machine.
- After having read these instructions, keep them in a convenient place so you or the operator can refer to them whenever necessary.

ATTENTION : www.ohtake-root.co.jp is the only web site associated with our company.

We do not have any branches in China.

各位顾客请注意! : 「www.ohtake-root.co.jp 是敝司唯一的官方网站,
目前, 敝司在中国没有办事处与所谓的中国官网。」

注意! : www.ohtake-root.co.jp が当社唯一の HP アドレスです。

弊社の名を騙る偽サイトにご注意下さい。現在、当社は中国国内に支店はございません。

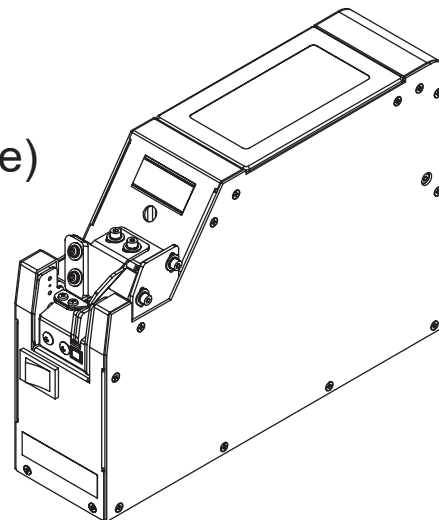

NSN1MAE01cM

Contents

1. OVERVIEW OF THIS MACHINE -----	1	7. MISCELLANEOUS-----	19
2. BEFORE USE -----	1	8. PARTS ADJUSTMENTS AND REPLACEMENTS---	20
3. OPERATING PRECAUTIONS -----	2	9. TROUBLESHOOTING-----	23
4. NAMES OF MACHINE PARTS -----	5	10. SPECIFICATIONS -----	28
5. ADJUSTMENTS AND CHECKS BEFORE USE-----	7	11. EXTERNAL DIMENTIONS-----	29
6. OPERATING INSTRUCTIONS-----	17	12. WARRANTY -----	30

1. OVERVIEW OF THIS MACHINE

Thank you very much for selecting our Automatic Screw Feeder "SS series".

This machine can line up screws (Type M1 - M3) and supplies them one by one to help the efficiency of screw fastening work.

Different sizes of screws can be used by changing the rail and passage plate.

It can be used wherever there is a power source for an AC adapter.

2. BEFORE USE

Please check for the following accessories before operating the machine.

- * Instruction Manual 1 copy
- * Hexagonal Wrench 1 piece
- * Ground wire 1 piece
- * AC Adapter 1 unit
- * Screwdriver 1 piece

* The design, performance and specifications are subject to change without prior notice for the sake of improvement.

3. OPERATING PRECAUTIONS

This manual contains safety alert symbols and signal words to help prevent injuries to the user or damage to property.

◎ Indications



WARNING

This indicates there is a chance of death, serious injury or fire if the instructions are not followed.



CAUTION

This indicates there is a chance of personal injury or damage to property if the instructions are not followed.

◎ Symbols indicating type of danger and preventative measures



Prohibited operation. Never do this!



Do not disassemble, modify or repair.



Do not touch with wet hands.



This indicates to stop operations.



Unplug power supply from wall outlet.



General caution.



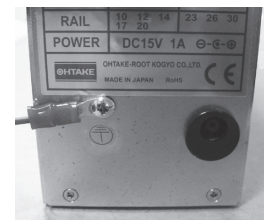







Attach the ground wire by loosening the screw near the mark  of the equipment.



the bottom of the main body













 **WARNING**

-  Do not disassemble the AC adapter as there is a risk of electric shock, fire or malfunction.
-  Do not damage, alter or change the power cord. Do not place heavy objects on the cord.
 Do not pull hard on the cord or twist the cord as it could be damaged, thereby causing a risk of fire or electric shock.
-  Do not handle the AC adapter with wet hands as it could cause an electric shock.
-  When using an outlet with AC100 ~ 240V, don't overload the electrical circuit.
 Do not modify or remodel this machine as this may cause a fire or electric shock.
-  Do not operate this machine near flammable liquids, gasses or materials as there could be a risk of fire or explosion.
-  Stop operating the machine and unplug the AC adapter from the wall outlet when you detect overheating, smoke, a pungent odor or any other unusual condition, as there may be a risk of fire or electric shock. Contact the dealer, from which you purchased the machine, and have it examined and repaired.
-  In the case of a thunderstorm, stop operating the machine, turn off the power and unplug the AC adapter from the wall outlet. If there is lightning and thunder nearby, move away from the machine and do not touch it or the AC adapter.
After the thunder stops, and when it is safe to do so, check the machine. If there is any abnormality, contact your dealer.
-  When performing maintenance, changing parts or when you sense an abnormality in the machine, turn the power off and pull the AC adapter from the wall outlet.
In addition, there are parts that become hot in the circuit board. When performing maintenance around the circuit board, turn off the power for at least 5 minutes before performing work. There is a risk of burns.



 CAUTION

-  Use only the AC adapter supplied with this machine otherwise it may result in a fire or electric shock.
-  Do not install this machine in an unstable location otherwise it may fall causing damage or injury.
-  Always operate the machine with the upper cover in place, otherwise it may result in injury.
-  Do not allow any foreign material to enter the machine while in operation.
Do not put your fingers into the machine while in operation, otherwise an injury will result.
-  Do not operate this machine in overly humid or dusty conditions.
Keep the socket plug clean at all times otherwise it may cause a fire or electric shock.
-  When moving the machine, always disconnect the AC adapter from the wall outlet or it may result in damage to the cord, or cause a fire or electric shock.
-  Turn off the machine and unplug the AC adapter from the wall outlet during closing hours or if the machine will be unused for any extended period of time.
-  When moving the machine, be sure to hold it with both hands and be careful not to drop it.
Dropping the machine at your feet may cause injury.
-  Do not operate the machine with tension on the AC adapter cord.
Keep the cord loose and untangled.
-  Do not bend, alter or damage the rail. Do not apply any oil. It is recommended that the user clean the rail periodically.
-  Do not use any screw that is out of the specified range nor any screw that is oily or dirty.

3. Part Names and Descriptions

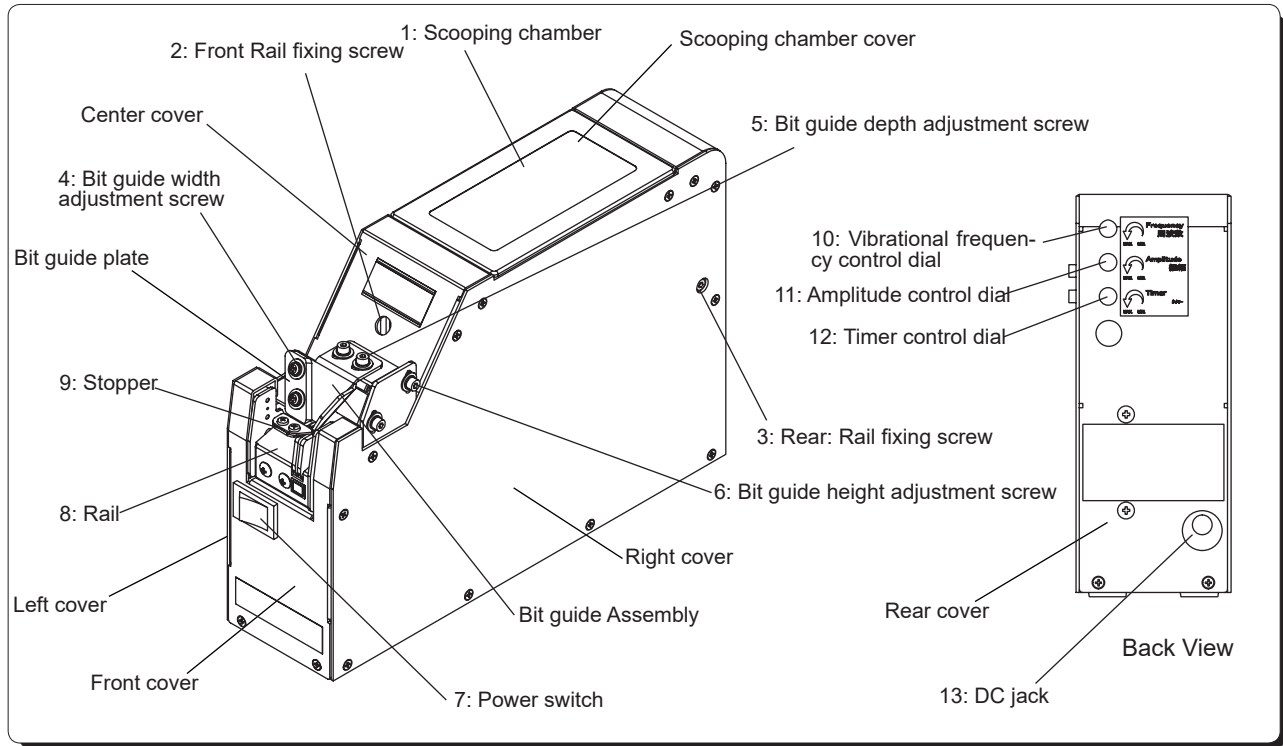

Part Names	Descriptions
1. Scooping chamber	Place screws in this chamber.
2. Front Rail fixing screw	Loosen this to change the rail.
3. Rear Rail fixing screw	Loosen this to change the rail.
4. Bit guide width adjustment screw	Loosen this to adjust the bit guide width according to the bit diameter.
5. Bit guide depth adjustment screw	Loosen this to adjust the bit guide depth according to the screw diameter.
6. Bit guide height adjustment screw	Loosen this to adjust the bit guide height according to the screw position.
7. Power switch	* Lift the bit guide before removing or attaching the rail.
8. Rail	Turns the power to the machine on and off.
9. Stopper	Set the rail according to the diameter of the screws you are using.
10. Vibrational frequency control dial	Stops screws at the tip of the rail.
11. Amplitude control dial	Controls the vibrational frequency using a precision screw driver.
12. Timer control dial	Controls the amplitude using a precision screw driver.
13. DC jack	Controls the screw feeding (stop) time using a precision screw driver.
	*The machine will stop feeding screws when they fill up the rail.
	Connect the AC adapter included in the package.

5. Set Up and Adjustment

5 - 1. Model Type

- Select the screwdriver bit according to the nominal diameter of screws you are using. Refer to the label number on the rail. (See Picture 1)

- The machine is adjusted in accordance with model No. (screw size: $\phi 1.0 - 1.7$ [cylinder head screw] / $\phi 2.0 - 3.0$ [pan head screw]) before shipment.

- Screws can generally be used without further adjustment after the initial adjustment. However, if you are using screws outside the specifications in this manual, the machine may not work properly. **In this case check and readjust the following:**

- Screw amount
- Passing plate and slide plate
- Bit guide
- Sensor voltage level
- Brush
- Vibrational frequency
- Timer

- The machine can handle several screw diameters simply by changing rails. After changing the rail, fine-tune each part. Adjustment procedures are explained on the following pages. Please read these thoroughly before adjustment.

⚠ Caution Be sure to turn off the machine before adjustment.

Model No.	Label No.	Nominal Screw Diameter	Screwdriver Bit Size	
			Bit Tip Diameter	Cross Slot No.
SS-12	10	$\phi 1.0$	$\phi 1.5$	№ 0
	12	$\phi 1.2$		
	14	$\phi 1.4$		
	17	$\phi 1.7$	$\phi 2.0$	№ 0 or 1
	20	$\phi 2.0$		
SS-23	23	$\phi 2.3$	$\phi 3.0$	№ 1
	26	$\phi 2.6$		
	30	$\phi 3.0$	$\phi 3.2$	№ 1 or 2

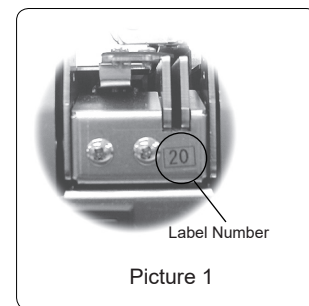

5 - 2. Brush Height Adjustment

No adjustment is necessary if the tip of the brush touches the screw head in the rail groove and rotates when the machine is turned on.

- Turn the machine off before adjusting the brush height.
- Loosen the brush height adjustment screws to adjust the brush height. (See Picture 4-1)
- Move the brush manually to check that the brush touches heads of the screws in the rail groove. (See Picture 4-2) If the brush position is too high, screws in incorrect positions cannot be caught. If the brush position is too low, it may sweep even correctly positioned screws from the rail or it may stop rotating.

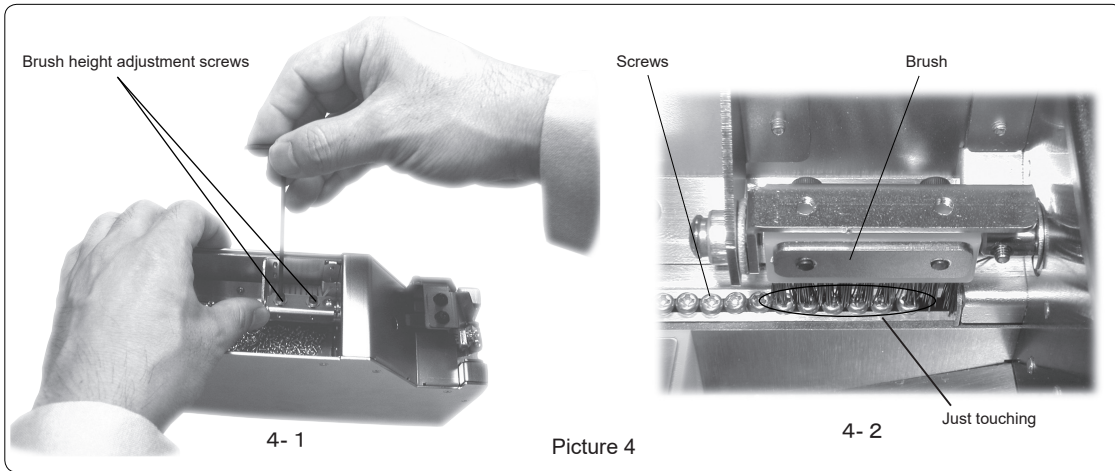

5 - 3. Height Adjustment of Passing and Holding Plates (How to Remove the Rail)

- If screws stop before reaching the stopper, adjust both the passing and holding plates.

Note:

Be sure to eject all screws from the before replacing the rail.

- Loosen the bit guide height adjustment screws with the attached wrench. (See Picture 5)

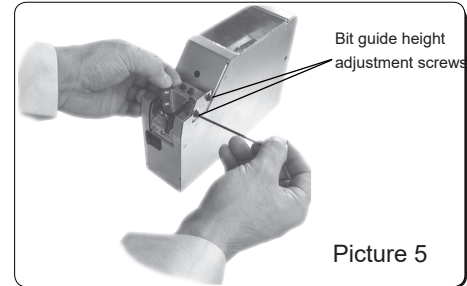

- Slightly loosen the front and rear rail fixing screws with the attached wrench. (See Picture 6)
- Lift the bit guide "Assembly" and pull the rail out in a horizontal direction. (See Picture 7)

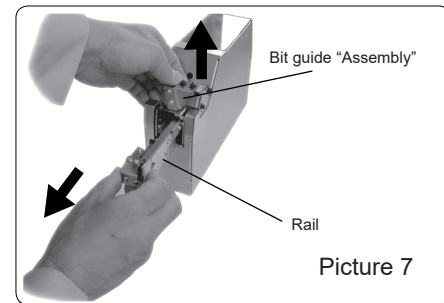
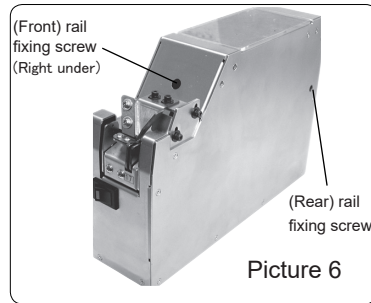

5 - 4. Height Adjustment of Passing and Holding Plates

- Both the passing and holding plates are fixed to the rail. (See Picture 8)
- Place a screw between the passing plate and the rail groove and adjust the height of the passing plate by loosening the passing plate fixing screw. (See Picture 9) If the gap between the passing plate and the rail groove is too wide, the screw flow may stop. If the gap is too small, the screw flow may also stop. (Screws cannot pass through the gap.) Adjust the height to the exact height of the screw head.
- Optional passing plates for various screw types, including thin head screws, are available. Contact the dealer from which you purchased the machine with details of the screw size you are planning to use.

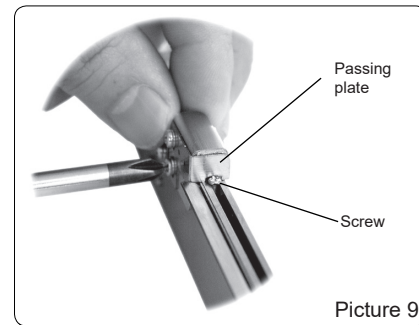
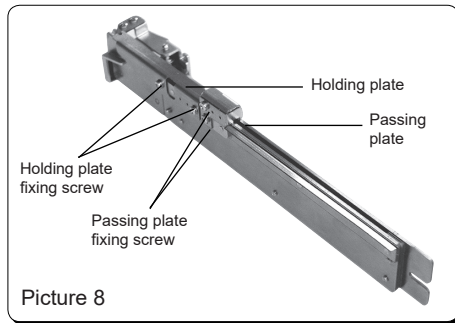

- Put a screw into the rail groove, just beneath the holding plate, and adjust the holding plate height so that there is an adequate gap between the holding plate and the rail groove for the screw head. Loosen the holding plate fixing screw and adjust the gap between the holding plate and rail groove. (See Picture 10) Removing the holding plate before adjustment will allow you to easily place screws into the rail groove easily. (See Picture 11) If the gap between the holding plate and the rail groove is too wide, screws may fall out. If the gap is too small, the screws may not be able to pass through. Set the gap to between 0.2 to 0.5mm above screw heads. If you are using long screws, adjust the gap so that it is a little higher.

Note: When using washer head screws, make the gap wider. If the gap between the holding plate and the rail groove is not wide enough, washers may become stuck between the holding plate and the rail causing the screw flow to stop.

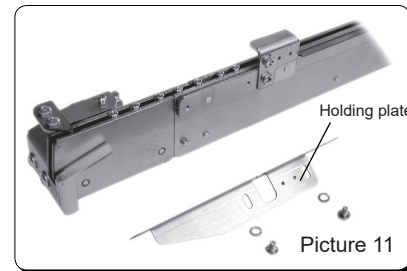
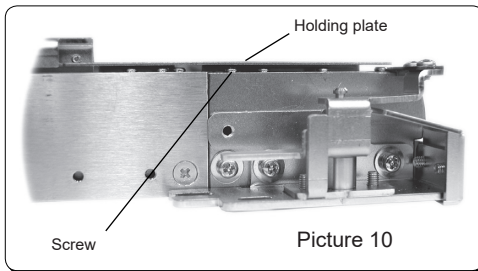

- After adjustment, place a screw into the end of the rail groove. Tilt the rail and check that the screw moves smoothly to the stopper position. (See Picture 12)
- After checking, reverse the procedure for removing the rail to reattach it. (Fix the screws when the rail makes contact with the machine.)

Note: If the front and rear rail fixing screws are not loosened, the rail cannot be attached to the correct position.

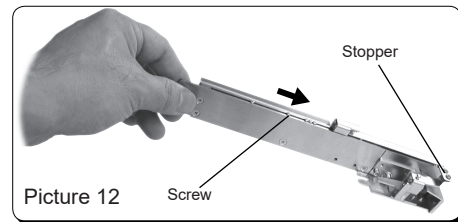

5 - 5. Rail Vibration Adjustment

- The rail vibration has been adjusted before shipment using screws that correspond to the rail size.
(Refer to the label number on the rail for the nominal screw diameter: e.g. 17 is $\phi 1.7$)
- Put 2 or 3 screws into the rail groove and turn the machine on.
- No adjustment is necessary if the screws move to the stopper position smoothly. (See Picture 13)
- When the number of screws is low and no screw is picked up in a given period of time, vibration will become the maximum and it will stop operation after that. (Refer to 4-2 “Basic Operation.”) Adjustment of volume is not effective at the time of a forced oscillation.
- After it stops, turn on the machine again and repeat the above procedure.

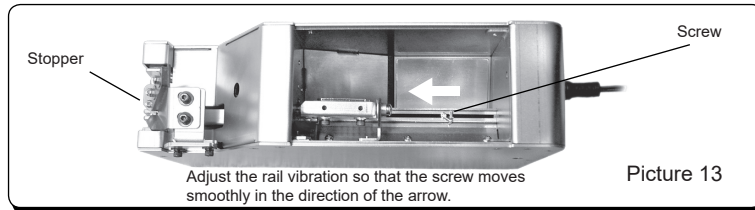

- Adjustment is necessary if the screw flow is not smooth or if there is too much rail vibration.
 - Adjust the Amplitude control dial on the back of the machine using the precision screwdriver.
 - Adjust the Vibration frequency control dial on the back of the machine using the precision screwdriver and find the resonance point.
- Adjust these dials to locate the optimum conditions for smooth movement of screws.
- Maximize the amplitude and adjust the vibration frequency to locate the resonance point (frequency when the rail vibration is at a maximum.) Then turn down the amplitude to locate the optimum conditions for smooth movement of screws.
 - Although it is not recommended, the rail vibration can be adjusted while the machine is operating.
 - During control dial adjustment, do not force the screwdriver beyond its rotation limits.

5 - 6. Bit Guide Adjustment

- Bit guide position adjustment is explained below.
- Pick up several screws to adjust the bit guide.
- Adjust the bit guide position after loosening the adjustment screws.
(See Picture 14)

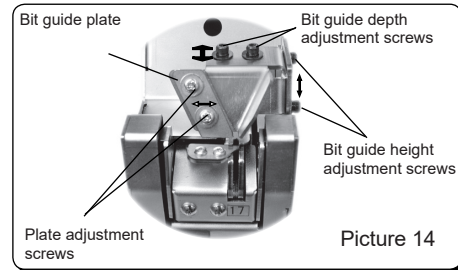

How to Adjust the Bit Guide Position

- Use the bit guide height adjustment screws to adjust the bit guide height so that it doesn't touch the holding plate.
- Use the plate adjustment screws and bit guide width adjustment screws to adjust the bit guide groove width and position so that the bit guide width matches the holding plate groove width.
- Fit the screwdriver bit into the bit guide and adjust the bit guide groove width so that the screwdriver bit moves smoothly. (See Picture 15)

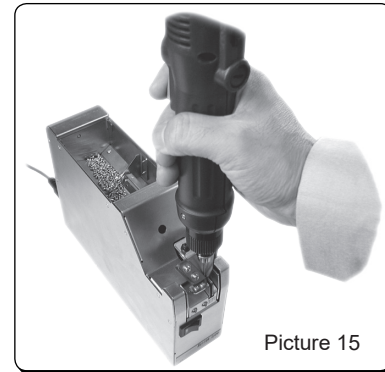

5 - 7. Timer Adjustment

The machine is equipped with a screw sensor that detects the number of screws on the rail.

If a screw accumulates to some extent on a rail, operation of a scooping block will stop and vibration will stop after timer set time.

The timer should normally be set to “Min.”

However if screws are moving slowly, it may be necessary to set the timer to “Max.”

- Adjust the Timer control dial on the back of the machine using a precision screwdriver. (See Picture 16)
- Turn the dial clockwise to reduce the vibration time. Turn it counterclockwise to increase the vibration time.
- During control dial adjustment, do not force the screwdriver beyond its rotation limits.
- Set the timer after checking that the rail is filled and that the screws are properly aligned.
- Use the provided screwdriver for adjusting the timer.

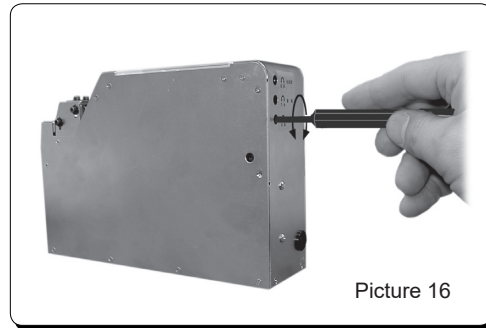

Picture 16

5 - 8. Sensor Voltage Level Adjustment

Screws can generally be used without further adjustment after the initial adjustment. However, if you are using screws outside the specifications in this manual, the machine may not work properly. In this case check and readjust the following:

Adjust the sensor levels for when screws are on the rail and for when no screws are on the rail.

Remove the rear cover of the machine to check the IC on the printed circuit board. (See Picture 17)

Measure the voltage level using Pins 3, 5, and 7 on the IC4050. Ground the metal part of the body. (Use testing clips for the voltage measurement. Recommended item: Testing clip <FP-7> manufactured by Sunhayato Corp.)

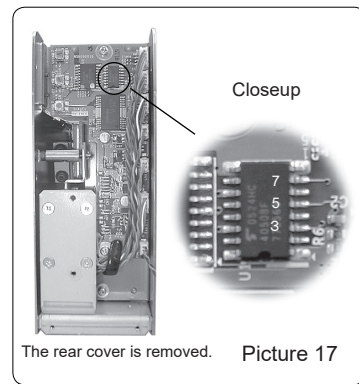

*** Screw Sensor Adjustment (Pin 3) ***

The screw sensor detects whether or not there are any screws remaining on the rail.

Loosen the light receiving sensor bracket fixing screws (2 pcs.) and adjust the sensor level by rotating the bracket. (See Picture 18)

0.25 – 1.5V: There are no screws remaining on the rail.

3.5V or more: There are screws on the rail.

If the voltage is 2.5V or over, the sensor judges that there are screws on the rail.

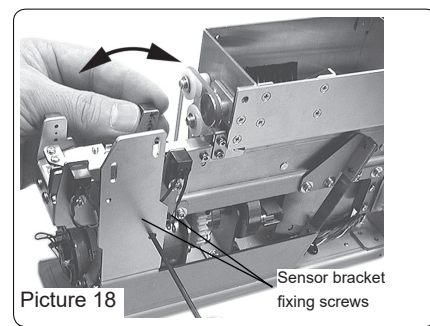

*** Stopper Sensor Adjustment (Pin 5) ***

The stopper sensor detects stopper movement.

Loosen the stopper sensor bracket fixing screws (2 pcs) and adjust the light receiving sensor position horizontally. (See Picture 19)

4.0V or more: Stopper ON

0.2V or less: Stopper OFF

If the voltage is 2.5V or over, the sensor judges that there are screws on the rail.

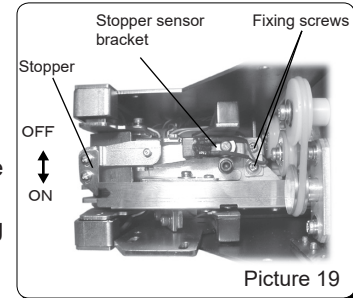

Picture 19

*** Front Sensor Adjustment (Pin 7) ***

The front sensor detects whether or not there are any screws remaining on the stopper.

Loosen the front sensor bracket fixing screws (2 pcs) and adjust the light receiving sensor position vertically. (See Picture 20)

0.25 – 1.5V: There are no screws on the stopper.

3.5V or more: There are screws on the stopper.

If the voltage is 2.5V or over, the sensor judges that there are screws remaining on the stopper.

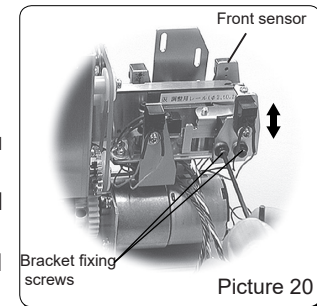

Picture 20

After checking and adjusting each part, test run the machine using the screws you actually intend to use.

If the machine does not run properly, repeat the above adjustment as well as rail position and vibration adjustments. After the test run, return the sensor wiring to its original condition.

⚠ Caution Do not pinch the wiring and ensure it is clear of the machine's moving parts.

6. Basic Operation

The driving motor repeats normal rotation and an inversion for about 2 seconds at a time, and the scooper carries screws to the rail. The vibrator (solenoid) continuously sends screws to the front stopper to be picked up using the screwdriver.

Note:

If no screws are sent for approximately 10 seconds, vibration of a rail becomes stonger. (The vibration sound, also, increases; however, this is not a problem.)

If no screw is not detected for about 20 more seconds, then the machine stops operating. When you want to start operation again, turn the power switch OFF and ON again or a stopper is operated (extraction sensor perception),

6 - 1. Number of Screws

Adjust the number of screws to ensure the proper alignment and smooth flow of screws. (See Picture 2)

- Adjust the scooping chamber to its lowest position by turning the power to the machine on and off.
- Fill the scooping chamber with screws up to 2mm below the rail groove.
- Be sure not to cover the front of the sliding plate with screws.
- Always ensure there are adequate screws for the operation.

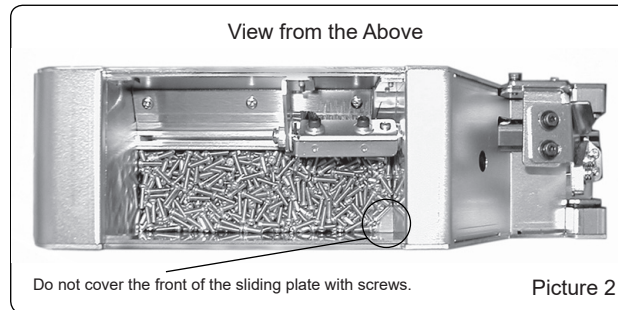

6 - 2. Operation Check

- If each part is adjusted appropriately, screws are sent to the stopper.
- Pick up screws from the stopper using the electric screwdriver. Using the bit guide as a guide, pull the screwdriver downward. Fit the screwdriver bit into the cross slot of the screw and then pull the screwdriver toward you in a horizontal direction to pick up the screw. (See Picture 3)
- Do not use force when fitting the screwdriver bit to the screw head. This may bend the rail or lead to malfunction of the machine.
- To fit the bit securely into the cross slot of the screw, slightly rotate the screwdriver bit.
- Select the screwdriver bit according to the nominal diameter of the screws you are using. (Refer to “4-1. Model Type.”)
- If screw alignment or flow is abnormal, check and adjust each part. (Refer to “4-1. Model Type”)

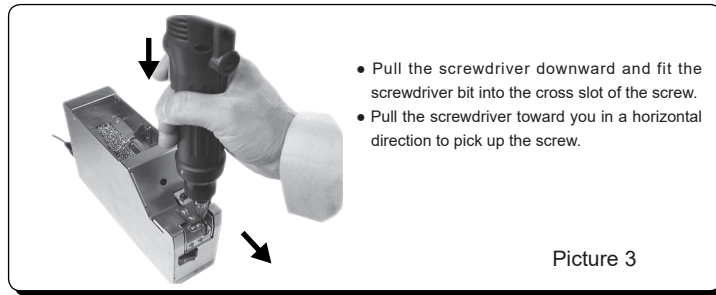



7. Miscellaneous

7 - 1. Overload Protection Circuit

The machine is equipped with an overload protection circuit.

Normally, the driving motor rotates and sends screws to the rail.

However, if an overload is applied to the machine's moving parts, the driving motor rotates in the counter direction for a given length of time and then rotates normally again.

If this action rectifies the overload, the machine resumes screw feeding; however, if there is still an overload, the motor continues to rotate in normal and opposite directions and then the power to the motor is cut off.

If the power to the motor is cut off, turn off the machine and remove the cause of overload.

For example, if there are too many screws in the scooping chamber, remove some of them. Remove any screws stuck in the machine's moving parts.

After eliminating the cause of overload, turn the machine on and restart operation. (Power reset)

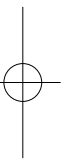

7 - 2. Maintenance

Dust, dirt, or grease in the rail groove may reduce the screw feeding speed.

If dust, dirt, or grease is evident in the rail groove, wipe it with a soft, clean alcohol-soaked cloth. Remove the rail if it is hard to wipe.

Be sure to turn off the machine and remove all screws from the scooping chamber before removing the rail. (Refer to Page 9 "4-5-1. Height Adjustment of Passing and Holding Plates (How to Remove the Rail)")

Please replace the rail if there is noticeable grease, dirt or scratch on it.



8. Parts Replacement and Adjustment

⚠ Caution Turn off the machine before replacing or adjusting parts.

The brush, driving belt, and driving motor are all consumable parts.

You will need to order another rail if the size of the screw you are using is to be changed.

Read the instructions below thoroughly before adjustment. Be sure to remove all screws from inside the machine before replacement.

8-1. How to Replace and Adjust the Brush

If the ends of the brush are worn and do not wipe-off the screws that are out of alignment, replace the brush.

Optional hard brushes are also available. Contact the dealer from which you purchased the machine for further information.

- Turn the machine on and off until the brush comes out to a position where you can remove the brush fixing screws. (See Picture 21)
- Refer to the diagram under Picture 21 to replace the brush.
- Reverse the procedure for removing the brush to attach a new one.
- Refer to Page 8 “Brush Height Adjustment” for adjustment.

Brush Item Nos.: NSN02107 (for Model SS-12)
 NSN22001 (for Model SS-23; option for Model SS-12)

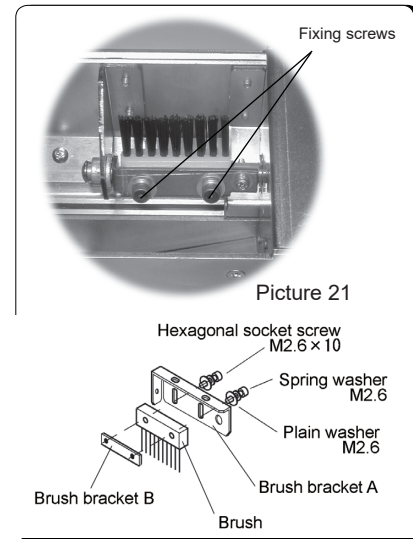

8-2. How to Replace and Adjust the Driving Belt

If the driving belt is worn causing the brush to slip or not rotate properly and screws that are out of alignment are not being picked up properly, replace the driving belt.

- Turn the machine off and remove the left and center covers.
- When you remove the covers, you will be able to see the four rollers that the driving belt is fitted around. (See Picture 22)
- Remove the belt with your fingers as shown in Picture 23.
- Reverse this procedure to attach the new belt.
- After attaching the belt, check that each part moves normally. (See Chapter 4 “Set Up and Adjustment”)

Driving Belt Item No.: NSN03114

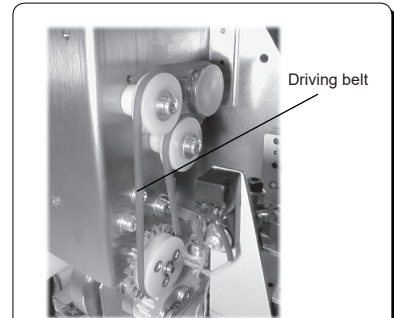

Picture 22

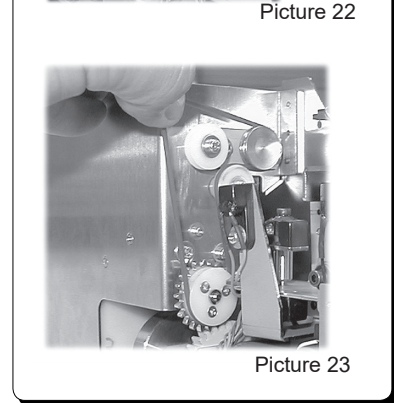

Picture 23

8-3. How to Replace the Main Motor Unit

If the motor is damaged, replace it with a new motor.

- Remove the rail and the front, center, left, and right covers. Loosen the clips (2pcs.) holding the cable.
- Remove the harness (blue and orange) of a motor from a circuit board.
- Remove the motor fixing screws (4 pcs.) from the bottom of the body and then pull the motor out in a horizontal direction from the body. (See Picture 24)

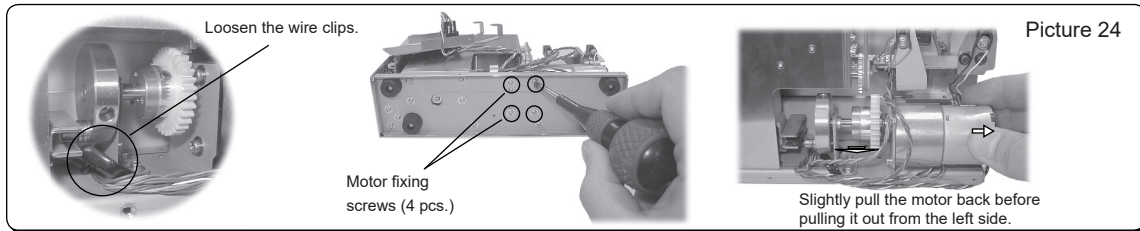

- Reverse the procedure for removing the motor to attach the new one.

Note: Do not pinch the motor wiring in order to ensure it is not damaged.

Main motor unit Item No.: NSN 03001

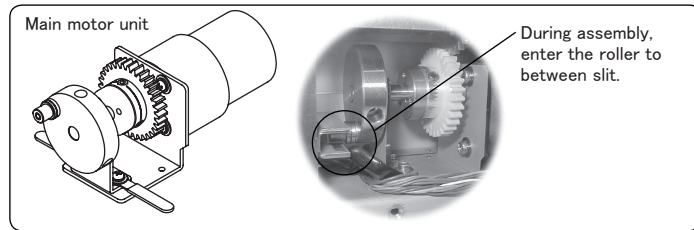

9. Troubleshooting

 **Caution** Be sure to turn off the machine before checking the problems listed below.

Problem	Cause of Problem	Troubleshooting
1. The machine does not run after being turned on.	<ul style="list-style-type: none">○ The power is cut off.○ No screw was picked up from the screw holding groove for a given period of time.○ There are too many screws in the scooping chamber.○ An object is stuck inside the machine.○ AC adapter failure	<ul style="list-style-type: none">○ Check that the AC adapter is properly connected to the power source.○ Pick up the screw in the screw holding groove.○ Adjust the Timer control dial.○ Reduce the number of screws in the scooping chamber.○ Remove the object.
2. The rail does not move back and forth.	<ul style="list-style-type: none">○ An object (e.g. screw) is stuck between the rail and the body.○ Even though there is no object stuck between the rail and the body, it does not vibrate.	<ul style="list-style-type: none">○ Remove the object.○ Check and adjust the amplitude. If the rail does not vibrate after the adjustment, contact the dealer from which you purchased the machine for repair.

Problem	Cause of Problem	Troubleshooting
<p>3. The flow of screws has stopped.</p>	<ul style="list-style-type: none"> ○ The screws are the wrong size for the rail. ○ There are not enough screws in the scooping chamber. ○ A screw is stuck between the passing plate and the rail groove and the brush cannot remove it. ○ A screw is stuck on the rail. 	<ul style="list-style-type: none"> ○ Use screws appropriate to the rail size. ○ Place screws into the scooping chamber. ○ Adjust the brush. ○ Adjust the passing plate. ○ Place screws into the scooping chamber. ○ Replace the driving belt. ○ Use a hard brush. (optional) ○ Remove the screw. Follow the procedure below. Pull up the holding plate and remove the screw. Then adjust the holding plate position. Be careful not to scratch the rail.

Problem	Cause of Problem	Troubleshooting
<p>4. Screws have fallen into the rail groove.</p>	<ul style="list-style-type: none"> ○ The screws are the wrong size for the rail. ○ The screw is shorter than the rail groove depth. 	<ul style="list-style-type: none"> ○ Use screws appropriate to the rail size ○ Contact the dealer from which you purchased the machine with details of your screw size.
<p>5. The screws do not flow smoothly.</p>	<ul style="list-style-type: none"> ○ The gap between the holding plate and the screw head is too small. ○ Spring washer screws are smaller than the type specified for the rail being used. ○ There is dust, dirt, or grease on the rail. ○ The rail vibration is insufficient. (The rail touches the body.) 	<ul style="list-style-type: none"> ○ Adjust the holding plate. ○ Adjust the vibration frequency. ○ Tilt the machine slightly. ○ If the speed of the screw flow does not increase after the above adjustments, contact the dealer from which you purchased the machine. ○ Wipe the rail with a soft, clean alcohol-soaked cloth. ○ Check and adjust the vibration frequency. ○ If the rail touches the body, contact the dealer from which you purchased the machine for repair. ○ Replace the driving motor.

Problem	Cause of Problem	Troubleshooting
6. Screws are inclined and pass through the passing plate too quickly.	<ul style="list-style-type: none"> ○ The passing plate has not been adjusted correctly. ○ There are too many screws in the scooping chamber. 	<ul style="list-style-type: none"> ○ Adjust the passing plate. ○ Reduce the number of screws in the scooping chamber.
7. No screw comes out to the screw holding groove.	<ul style="list-style-type: none"> ○ Screws are stuck on the rail. 	<ul style="list-style-type: none"> ○ Adjust the holding plate position.
8. The machine stops suddenly.	<ul style="list-style-type: none"> ○ The overload protection circuit was activated. ○ There are too many screws in the scooping chamber. ○ An object (e.g. screw) is stuck between the rail and the body. ○ A screw remains in the stopper for a given period of time. 	<ul style="list-style-type: none"> ○ Reset the main power. ○ Eliminate the cause of overload. ○ Reduce the number of screws in the scooping chamber. ○ If the machine stops even after the number of screws has been reduced, contact the dealer from which you purchased the machine for repair. ○ Remove the object.

Problem	Cause of Problem	Troubleshooting
9. The machine keeps scooping screws even though there is a screw in the screw holding groove.	<ul style="list-style-type: none"> ○ The rail is not filled with screws, or a screw has been trapped somewhere on the rail. ○ The sensor is not detecting whether or not there are screws on the rail. 	<ul style="list-style-type: none"> ○ Adjust the passing plate. ○ Adjust the sensor voltage level.
10. The rail vibration does not stop even though there is a screw at the stopper.	<ul style="list-style-type: none"> ○ The sensor is not detecting whether or not there are screws on the rail. 	<ul style="list-style-type: none"> ○ Adjust the sensor voltage level.
11. Screws have fallen inside the machine.		<ul style="list-style-type: none"> ○ Remove the cover and pick up the screws.
12. The machine makes a high-pitched noise.	<ul style="list-style-type: none"> ○ Incorrect amplitude or vibration frequency ○ Out of grease 	<ul style="list-style-type: none"> ○ Adjust the amplitude or vibration frequency. ○ Grease the moving parts. Recommended item: BR2Plus manufactured by Dow Corning Asia Co., Ltd

10. Specifications

Power AC adapter (switching type)	Input: AC100~240V 50/60Hz Output: DC15V 1A
Dimensions	55(W) × 205(D) × 143(H) (mm)
Weight	Approx. 2.4Kg (including rail)
Screw capacity	Approx. 40cc
Following accessories	Operation Manual 1 copy AC Adapter 1 unit Hexagonal Wrench 1 piece Screwdriver 1 piece Ground wire 1 piece
Installation location	Level stable place
Installation and storage condition	Temperature 0 ~ 40 °C Humidity 10 to 85% (without condensation)
Compliance standards	EMC: 2014/30/EU MD: 2006/42/EC RoHS: 2011/65/EU

Note:

- Check that the screw diameter matches the rail groove width.
- Within The range of screw size and length below, there may be instances of unique screw shape or structure not compatible with the feeder unit.
- When changing the rail, check that the rail number matches the model number of the model you are using.
- Interchangeable rails are optional.
- The design, features and specifications of the machine may be modified without prior notice to improve quality.
- The noise of this unit is less than LAeq 70 dB at a distance of 1 m.
- This product complies with EU directive. Please check the EU Declaration of Conformity for compliance standards.

Reference table of the specified screws						Screw head shape	
Screw size	Screw shaft diameter (φ)	Screw head diameter (φ)	Washer diameter (φ)	Screw head thickness (mm)	Screw shaft length (mm)	No. 0 pan head	Pan head
φ 1.0	0.9~0.95	1.8~2.0	-	0.35~1.0	1.6~10	○	
φ 1.2	1.1~1.15	1.8~2.3	-	0.35~1.0	1.9~10	○	
φ 1.4	1.3~1.4	2.0~2.5	-	0.35~1.0	2.2~10	○	
φ 1.7	1.6~1.7	2.5~3.0	-	0.35~1.0	2.7~10	○	
φ 2.0	1.9~2.1	3.0~3.5	-	0.35~1.3	3.2~16		○
φ 2.3	2.2~2.4	3.5~4.0	-	0.35~1.5	3.7~16		○
φ 2.6	2.5~2.7	4.0~4.5	-	0.35~1.7	4.2~16		○
φ 3.0	2.9~3.2	5.0~5.5	-	0.35~2.0	4.8~16		○

Screw feeder series	Screw feeder model	Screw size	Rail model No.
SS-12	SS-1210	φ 1.0	WR10
	SS-1212	φ 1.2	WR12
	SS-1214	φ 1.4	WR14
	SS-1217	φ 1.7	WR17
	SS-1220	φ 2.0	WR20
SS-23	SS-2323	φ 2.3	WR23
	SS-2326	φ 2.6	WR26
	SS-2330	φ 3.0	WR30

11. External Dimensions

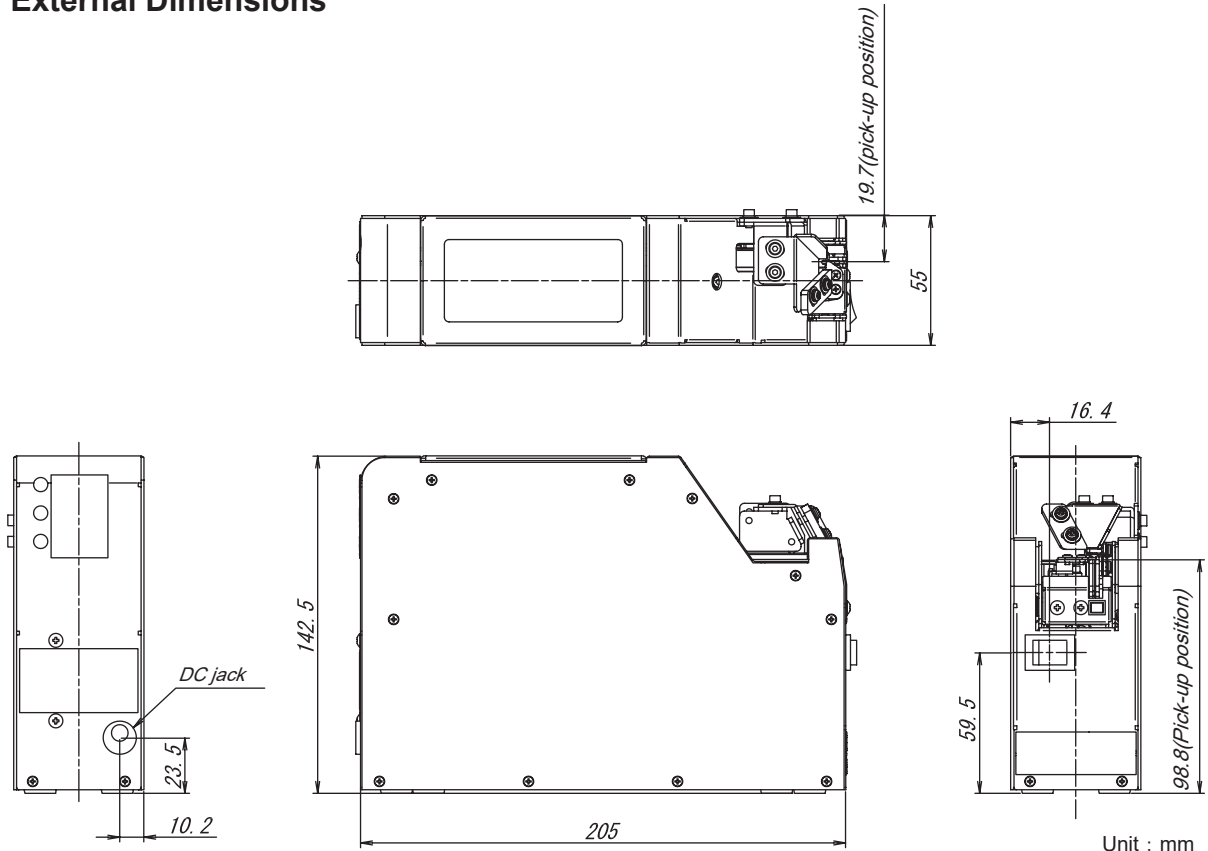

Unit : mm

12. Warranty

For users within Japan, the effective term of warranty is 6 months after delivery.

Such warranty will not be applicable to purchases or users outside of Japan.

If any troubles should occur, please contact your dealer.

After the warranty period, repair services will be completed.

In the following cases, the purchaser shall pay for parts and labor regardless of the terms of warranty:

- ① Failure due to improper handling.
- ② Failure due to product modification or improper processing.
- ③ Failure due to causes beyond control (for example earthquake or fire).
- ④ Failure attributable to any cause other than this product.
- ⑤ Consumables (brushes, driving belt, main motor, rail)
and replaceable parts and replacement work expenses.

The repair parts shall be available within 5 years after purchase.

<http://www.ohtake-root.co.jp> **株式会社 大武・ルート工業**

岩手県一関市萩荘字金ヶ崎 27 丁 021-0902

Tel +81-191-24-3144

Fax +81-191-24-3145

OHTAKE-ROOT KOGYO CO.,LTD.

27 Kanegasaki Hagisho Ichinoseki

Iwate, 021-0902 JAPAN

Tel +81-191-24-3144

Fax +81-191-24-3145

「Quicher」「OHTAKE」「OHTAKE・ROOT KOGYO」are trademarks or/and registered trademarks of OHTAKE・ROOT KOGYO CO.LTD.]
「Quicher(クイッチャー)」「OHTAKE」「OHTAKE・ROOT KOGYO」は、株式会社 大武・ルート工業の商標又は登録商標です。

The specifications and/or design may be altered, without notice, whenever there are changes or improvements.
改良のため、予告なくデザイン、性能、仕様等を変更することがあります。

Photocopying, reproduction or publication, in whole or in part, of this manual, without permission, is strictly prohibited by copyright law.

この取扱説明書の一部または全部の無断転載、複製を禁じます。

© Copyright OHTAKE・ROOT KOGYO CO.,LTD.

(as of Apr. 2021)

(2021 年 4 月現在)