

ø30 Switches and Pilot Lights

# TWN TWND Series





Heavy duty switches & pilot lights offer both variety and reliability.



- Pilot light is not approved by EN standards.
- DC-DC convertor unit is not approved by standards.
- See website for details on approvals and standards.



	Model	Features	Page
	Plastic TWN Series	The all-time bestseller since first developed. Suitable for versatile applications.	<b>B-304</b>
	Diecast Zinc TWND Series	Heavy-duty switches for tough industrial usage.	<b>B-326</b>

For more information, visit <http://eu.idec.com>

# ø30 TWN/TWND Selection Guide

Function	Pushbutton					
Category	Flush		Extended		Extended with Half Shroud	
	Momentary/Maintained		Momentary/Maintained		Momentary/Maintained	
Shape				Diecast Zinc 		Diecast Zinc 
Model	ABN1 AON1	ABD1 AOD1	ABN2 AON2	ABD2 AOD2	ABN2G AON2G	ABGD2 AOGD2
Page	B-310	B-326	B-310	B-326	B-310	B-326

Function	Pushbutton					
Category	Extended with Full Shroud		Mushroom		Mushroom with Full Shroud	
	Momentary/Maintained		Momentary/Maintained		Momentary/Maintained	
Shape		Diecast Zinc 		Diecast Zinc 		Diecast Zinc 
Model	ABN2F AON2F	ABFD2 AOFD2	ABN3 AON3	ABD3 AOD3	ABN3G —	ABGD3 AOGD3
Page	B-310	B-326	B-311	B-327	B-311	B-327

Function	Pushbutton					
Category	Jumbo Mushroom		Jumbo Mushroom with Shallow Shroud		Jumbo Mushroom with Deep Shroud	
	Momentary		Momentary		Momentary	
Shape		Diecast Zinc 		Diecast Zinc 		Diecast Zinc 
Model	ABN4	ABD4	ABN4G	ABGD4	ABN4F	ABFD4
Page	B-311	B-327	B-311	B-327	B-311	B-327

Function	Pushbutton					
Category	Mushroom Pushlock Turn Reset (*1)		Mushroom Push Turn Lock		Mushroom Pull	
Shape		Diecast Zinc 		Diecast Zinc 		Diecast Zinc 
Model	AVN3	AVD3	AJN3	AJD3	AZN3	AZD3
Page	B-312	B-328	B-312	B-328	B-312	B-328



Function	Pushbutton			
Category	Mushroom Push-Pull		Pin Lock	
Shape	—	Diecast Zinc 	—	Diecast Zinc 
Model	—	AYD3	—	ABD8P
Page	—	B-328	—	B-327







\*1) Cannot be used as emergency stop switch based on ISO 13850 and IEC 60947-5-5.





- APEM
- Switches & Pilot Lights
- Control Boxes
- Emergency Stop Switches
- Enabling Switches
- Safety Products
- Explosion Proof
- Terminal Blocks
- Relays & Sockets
- Circuit Protectors
- Power Supplies
- LED Illumination
- Controllers
- Operator Interfaces
- Sensors
- AUTO-ID
- Flush Silhouette
- ø16
- ø22
- ø30
- Miniature
- Pilot Lights
- TWN
- TWND
- ARN
- CS





# ø30 TWN/TWND Selection Guide

Function	LED Illuminated Pushbutton					
Category	Extended		Extended with Half Shroud		Extended with Full Shroud	
	Momentary/Maintained		Momentary/Maintained		Momentary/Maintained	
Shape		Diecast Zinc 		— Diecast Zinc		Diecast Zinc 
Model	ALN2 AOLN2	ALD2 AOLD2	ALGN2 AOLGN2	—	ALFN2 AOLFN2	ALFD2 AOLFD2
Page	B-313	B-329	B-313		B-313	B-329

Function	LED Illuminated Pushbutton					
Category	Mushroom		Mushroom Pushlock Turn Reset (*1)		Mushroom Push Turn Lock	
	Momentary/Maintained					
Shape		Diecast Zinc 		Diecast Zinc 		Diecast Zinc —
Model	ALN3 AOLN3	ALD3 AOLD3	AVLN3	AVLD3	AJLN3	—
Page	B-313	B-330	B-314	B-330	B-313	

Function	Selector Switches					
Category	Knob		Lever		Key	
	Momentary/Maintained		Momentary/Maintained		Momentary/Maintained	
Shape		Diecast Zinc 		Diecast Zinc 		Diecast Zinc 
Model	ASN	ASD	ASN□L	ASD□L	ASN□K	ASD□K
Page	B-316	B-331	B-317	B-332	B-318	B-333

Function	Selector Switch			Selector Pushbutton	
Category	Key	LED Illuminated Knob		Ring Operator	
		Momentary/Maintained		Momentary/Maintained	
Shape			Diecast Zinc 		Diecast Zinc 
Model	ASN□K-N024401	ASLN	ASLD	ASBN2	ASBD2
Page	B-319	B-320	B-334	B-323	B-335

Function	LED Illuminated Pilot Light			
Category	Dome		Square Extended (IP40)	Rectangular (Marking) (IP40)
	Momentary/Maintained		Momentary/Maintained	Momentary/Maintained
Shape		Diecast Zinc 		
Model	APN1	APD1	UPQN3B	UPQN4
Page	B-324	B-336	B-324	B-324

\*1) Cannot be used as emergency stop switch based on ISO 13850 and IEC 60947-5-5.

# ø30 TWN/TWND Ratings/Specifications

Heavy duty switches & pilot lights offer both variety and reliability.  
Endures harsh environments.

Equipped with HW-U contact blocks featuring finger-safe (IP20) structure and spring-up terminals.

## ø30 TWN Series (plastic)



## ø30 TWND Series (Diecast Zinc)



### Ratings and Specifications

#### Contact ratings

Pushbuttons Illuminated Pushbuttons Selector Switches Illuminated Selector Switches Selector Pushbuttons	Rated insulation voltage	600V
	Rated continuous current	10A
	Contact ratings by utilization category JIS C8201-5-1 IEC60947-5-1	AC-15 (A600)
		DC-13

#### Contact ratings by utilization category

HW-U10 (NO contact), HW-U01 (NC contact)

Operating Voltage			24V	48V	50V	110V	220V	440V
Operating Current	AC 50/60 Hz	AC-12 Control of resistive loads and solid state loads	10A	–	10A	10A	6A	2A
		AC-15 Control of electromagnetic loads (> 72 VA)	10A	–	7A	5A	3A	1A
	DC	DC-12 Control of resistive loads and solid state loads	10A	5A	–	2.2A	1.1A	–
		DC-13 Control of electromagnets	5A	2A	–	1.1A	0.6A	–

HW-U10R (EM contact/NO contact), HW-U01R (LB contact/NC contact)

Operating Voltage			24V	48V	50V	110V	220V	440V
Operating Current	AC 50/60 Hz	AC-12 Control of resistive loads and solid state loads	5A	–	5A	5A	3A	1A
		AC-15 Control of electromagnetic loads (> 72 VA)	5A	–	3.5A	2.5A	1.5A	0.5A
	DC	DC-12 Control of resistive loads and solid state loads	5A	2.5A	–	1.1A	0.55A	–
		DC-13 Control of electromagnets	2.5A	1A	–	0.55A	0.3A	–

- The operating current represents the classification by making and breaking currents (IEC 60947-5-1).
- Silver contacts
- Minimum applicable load: 3V AC/DC, 5 mA (applicable range may vary with operating conditions and load types)
- For mono-lever switches and cam switches, see the brochures of each product.

#### HW-U Contact Block

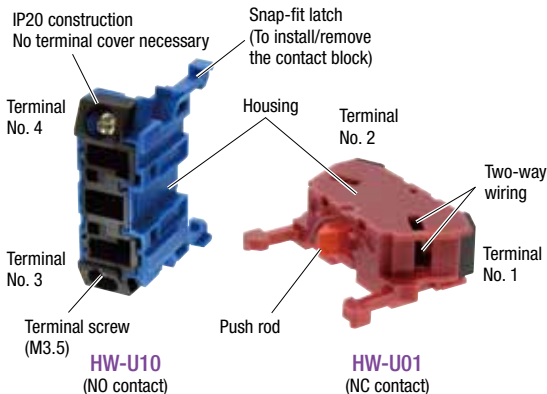

Part No.	HW-U10	HW-U01	HW-U10R	HW-U01R
Contact	1NO	1NC	EM (NO) (early make)	LB (NC) (late break)
Terminal No.	3-4	1-2	3-4	1-2
Housing color	Blue	Reddish purple	Blue	Reddish purple
Push Rod color	Green	Red	Black	White
Weight	Approx. 11g			

- Up to 4 contacts in two decks can be mounted onto each operator. (AZN, AZD, AYD: Up to 2 contact blocks in one deck)
- Cannot be used on operators in dark gray or light gray color.
- Gold contact available (gold-plated silver)

## LED Illuminated Part Specifications







Unit	Rated Voltage		Operating Voltage		LED lamp	
					Lamp Base	Part No.
Illuminated pushbutton Illuminated selector switch Pilot light	6V AC/DC		6V AC/DC		BA9S/13	LSRD-6
	12V AC/DC		12V AC/DC			LSRD-1
	24V AC/DC		24V AC/DC			LSRD-2
	100/110V AC		50/60 Hz	100/110V AC		LSRD-6
	115/120V AC (*1)			115/120V AC (*1)		
	120V AC (*2)			120V AC (*2)		
	200/220V AC			200/220V AC		
	230/240V AC (*1)			230/240V AC (*1)		
	240V AC (*2)			240V AC (*2)		
	380V AC			380V AC		
	400/440V AC			400/440V AC		
	480V AC		480V AC			
110V DC		90 to 140V DC				

• See LED lamps, see LED Lamp Ratings below.

\*1) Illuminated pushbutton, illuminated selector switch

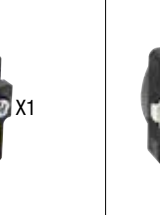

\*2) Pilot light

## Illuminated Part Type and Shape

	Illuminated Unit				Pilot Light		
	Full voltage adapter	Transformer		DC-DC converter	Full voltage adapter (unibody)	Transformer	DC-DC converter
Power Unit	6V, 12V, 24V AC/DC	100 to 240V AC	380V AC min.	110V DC	6V, 12V, 24V AC/DC	100 to 480V AC	110V DC
Rated Voltage	6V, 12V, 24V AC/DC	100 to 240V AC	380V AC min.	110V DC	6V, 12V, 24V AC/DC	100 to 480V AC	110V DC
Polarity	None	None	None	X1 (+) X2 (-)	None	None	X1 (+) X2 (-)
Shape/Terminal							

• Note the polarity for wiring when connecting to DC-DC converter unit.

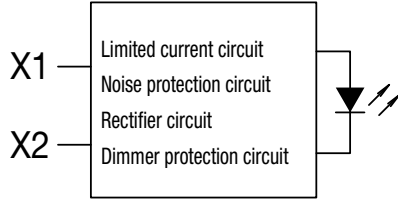
## LED Lamp Ratings (LSRD)

Part No.	LSRD-6	LSRD-1	LSRD-2
Lamp Base	BA9S/13		
Rated Voltage	6V AC/DC	12V AC/DC	24V AC/DC
Voltage Range	6V AC/DC ±10%		24V AC/DC ±10%
Current Draw	DC	10mA	7mA
	AC	14mA	8mA
Voltage Marking	Die stamped on the base		
Life (reference value)	Approx. 50,000 hours (The luminance is reduced to 50% the initial intensity when used on complete DC at 25°C.)		
Internal Circuit			Example: LSRD-2 
Weight	Approx. 2g		

• Only one color is available for LSRD so there are no codes to specify the color in the part no.



## Specifications

Operating Temperature		Non-illuminated: -25 to +70°C (no freezing) Illuminated: -25 to +50°C (no freezing)	
Storage Temperature		-40 to +80°C (no freezing)	
Operating Humidity		45 to 85% RH (no condensation)	
Contact Resistance		50 mΩ maximum (initial value)	
Insulation Resistance		100 MΩ minimum (500V DC megger)	
Dielectric Strength		Between live and dead metal parts: 2,500V AC, 1 minute (Full voltage and pilot lights: 2,000V AC, 1 minute) 2000V AC, (pilot lights: 6V AC/DC, 12V, 24V)	
Vibration Resistance	Damage limits	30 Hz, amplitude 1.5 mm	
	Operation extremes	5 to 55 Hz, amplitude 0.5 mm	
Shock Resistance	Damage limits	1000 m/s <sup>2</sup>	
	Operation extremes	100 m/s <sup>2</sup>	
Mechanical Life (minimum operations)	Pushbutton	Momentary	5,000,000
		Maintained	500,000 (over 3 contacts: 250,000)
		Push lock turn reset	500,000
		Pull	500,000
	Illuminated pushbutton	Momentary	2,500,000
		Maintained	500,000 (over 3 contacts: 250,000)
	Selector switch		500,000
	Key selector switch		500,000
Illuminated selector switch		500,000	
Selector pushbutton		250,000	
Electrical Life (minimum operations) (*1)	Pushbutton	Momentary	500,000 Switching frequency 1800 operations/h, duty ratio 40%
		Maintained	500,000 (over 3 contacts: 250,000) Switching frequency 900 operations/h, duty ratio 40%
		Push lock turn reset	500,000 Switching frequency 900 operations/h, duty ratio 40%
	Illuminated pushbutton	Momentary	500,000 Switching frequency 1800 operations/h, duty ratio 40%
		Maintained	500,000 (over 3 contacts: 250,000) Switching frequency 900 operations/h, duty ratio 40%
	Selector switch		500,000 Switching frequency 1200 operations/h, duty ratio 40%
	Key selector switch		500,000 Switching frequency 1200 operations/h, duty ratio 40%
	Illuminated selector switch		500,000 Switching frequency 1200 operations/h, duty ratio 40%
Selector pushbutton		250,000 Switching frequency 900 operations/h, duty ratio 40%	
Weight (approx.)	TWN series	Pushbutton	ABN122: 82g      ABN322: 87g
		Illuminated pushbutton	ALN22222DN: 106g      ALN21622DN: 163g
		Selector switch	ASN222N: 83g      ASN2K22N: 120g
		Illuminated selector switch	ASLN22222DN: 106g      ASLN21622DN: 163g
		Pilot light	APN122DN: 46g      APN116DN: 125g
	TWND series	Pushbutton	ABD122: 108g      ABD322: 113g
		Illuminated pushbutton	ALD22222DN: 132g      ALD21622DN: 189g
		Selector switch	ASD222N: 110g      ASD2K22N: 147g
		Illuminated selector switch	ASLD22222DN: 133g      ASLD21622DN: 190g
		Pilot light	APD122DN: 75g      APD116DN: 152g

\*1) Load condition 220V AC 3A (AC-15)

## Degree of Protection

Series	Unit	Model	IEC 60529	JIS C 0920
TWN series	Pushbutton	ABN, AON, AVN	IP65	Dust-proof/jet-proof
	Illuminated pushbutton	ALN, AOLN, AVLN		
	Selector switch	ASN, ASN□L		
	Key selector switch	ASN□K		
	Illuminated selector switch	ASLN		
	Selector pushbutton	ASBN		
	Round pilot light	APN		
TWND series Diecast zinc	Square pilot light	UPQN	IP40	—
	Pushbutton	ABD, AOD, AVD	IP65	Dustproof/jet-proof
	Illuminated pushbutton	ALD, AOLD, AVL D		
	Selector switch	ASD, ASD□L		
	Key selector switch	ASD□K		
	Illuminated selector switch	ASLD		
	Selector pushbutton	ASBD		
Round pilot light	APD			

• Switches/pilot lights have been tested in a test room in accordance with the degree of protection standards, by installing on an enclosure to evaluate the effect on the enclosure or inside the switch or pilot light.

### For harsh environment such as torrid/frigid area

TWN/TWND series for harsh environment such as tropical/frigid area is also available (not approved by standards). Contact IDEC for details.



Download catalogs and CAD from <http://eu.idec.com/downloads>

APEM

Switches & Pilot Lights

Control Boxes

Emergency Stop Switches

Enabling Switches

Safety Products

Explosion Proof

Terminal Blocks

Relays & Sockets

Circuit Protectors

Power Supplies

LED Illumination

Controllers

Operator Interfaces

Sensors

AUTO-ID

Flush Silhouette

ø16

ø22

ø30

Miniature

Pilot Lights

TWN

TWND

ARN

CS

## Mounting Hole Layout/Mounting Centers

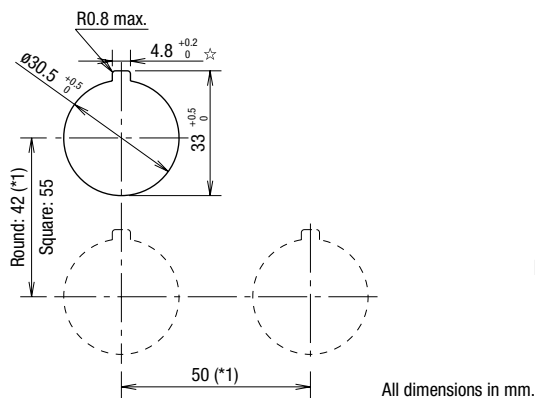

- The minimum mounting centers are applicable to pilot lights with one layer of contact blocks (one to two contact blocks). When two layers of contact blocks (four contact blocks) are mounted, determine the minimum mounting centers in consideration of convenience for wiring.

\*1) Mushroom with shroud: 50 mm minimum

\*1) Jumbo mushroom: 67 mm minimum

\*1) Jumbo mushroom with shroud: 77 mm minimum

When high temperature is expected, take necessary measures such as securing sufficient mounting centers or using a cooling fan.

- The 4.8<sup>+0.2</sup><sub>0</sub> mm recess is for preventing rotation and is not necessary when the nameplate or anti-rotation ring is not used.

Note: For mounting hole layout of mono-lever switches and cam switches, see IDEC's website.

## Notes for Ordering

## Standard models

- Specify Ordering No. when ordering.
- Specify a color code in place of \*
- Pilot lights, illuminated pushbuttons, and illuminated selector switches have an LED lamp installed.
- Pilot lights are equipped with a terminal cover.
- Color codes for units without LED lamps:  
R (red), G (green), A (amber), Y (yellow), S (blue)
- When using a commercially available lamp, choose a lamp with rated voltage 5 to 30V AC/DC and 1W maximum, and with the same base and shape. Make sure of correct operation before installation. The operation of TWN/TWND series cannot be guaranteed when a commercially available lamp is used.
- Terminal covers, nameplates, and accessories for mono-lever switch and cam switch are ordered separately.
- For terminal cover, nameplate and other accessories of mono-lever switches and cam switches, see IDEC's website.

## Ordering Information

## Pushbutton

When specifying gold-plated silver contact and contact configuration:

TWN series (B-310 to B-312)

ABN 2 11 R - MAU

① Optional contact  
② Contact configuration

TWND series (B-326 to B-328)

ABD 2 11 NR - MAU

① Optional contact  
② Contact configuration

<Codes>

① Optional contact

MAU: Gold-plated silver

② Contact configuration

10: 1NO  
01: 1NC  
11: 1NO1NC  
20: 2NO  
02: 2NC  
22: 2NO2NC  
40: 4NO  
04: 4NC  
13: 1NO3NC  
31: 3NO1NC  
30: 3NO  
03: 3NC  
12: 1NO2NC  
21: 2NO1NC

Note:

- Pushbutton with one or three contact blocks contains a dummy block.
- Mushroom pull pushbuttons AZN, AZD and mushroom push-pull AYD have up to two contacts in one layer.

Ordering Information

Illuminated Pushbutton

When specifying gold-plated silver contact, contact configuration, and LED operating voltage:

TWN series (B-313 to B-315)

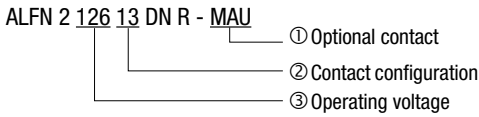

TWND series (B-329 to B-330)

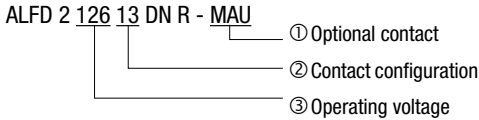

<Codes>

- ① Optional contact  
MAU: Gold-plated silver
- ② Contact configuration  
10: 1NO  
01: 1NC  
11: 1NO1NC  
20: 2NO  
02: 2NC  
31: 3NO1NC  
22: 2NO2NC  
13: 1NO3NC  
40: 4NO  
04: 4NC
- ③ Operating voltage  
99: Without LED lamp  
66: 6V AC/DC  
11: 12V AC/DC  
22: 24V AC/DC  
16: 100/110V AC  
126: 115/120V AC  
26: 200/220V AC  
246: 230/240V AC  
386: 380V AC  
46: 400/440V AC  
486: 480V AC

Note:

- Odd number of contact blocks, such as 1NO, 1NC, 3NO, 2NO-1NC, 1NO-2NC, and 3NC, are not available for models of 100V AC or over.
  - Illuminated pushbuttons of 24V AC/DC and below with two or four contact blocks contain a dummy block.
  - See B-309 for how to specify 110V DC model (DC-DC converter).
  - Color codes for units without LED lamps:  
R (red), G (green), A (amber), Y (yellow), S (blue)
- When using a commercially available lamp, choose a lamp with rated voltage 5 to 30V AC/DC and 1W maximum, and with the same base and shape.

Selector Switch

When specifying gold-plated silver contact and contact configuration:

TWN series (B-316 to B-319)

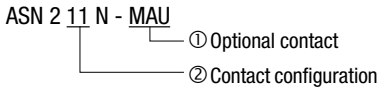

TWND series (B-331 to B-333)

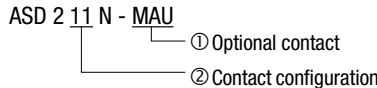

<Codes>

- ① Optional contact  
MAU: Gold-plated silver

Key removable position code (example)

Position	Key removable position	Key removable position code	Part No. Example			
			TWN series	ASD series	TWND series	
2-position	Maintained	Removable in all positions	(blank)	ASN2K20N	ASN2K20N-NO24401	ASD2K20N
		Removal in left only	B	ASN2K20NB	ASN2K20NB-NO24401	ASD2K20NB
		Removable in right only	C	ASN2K20NC	ASN2K20NC-NO24401	ASD2K20NC
	Spring return from right	Removal in left only	(blank)	ASN21K20N	ASN21K20N-NO24401	ASD21K20N
Spring return from left	Removable in right only	(blank)	ASN22K20N	ASN22K20N-NO24401	ASD22K20N	
3-position	Maintained	Removable in all positions	(blank)	ASN3K20N	ASN3K20N-NO24401	ASD3K20N
		Removable in left and center	B	ASN3K20NB	ASN3K20NB-NO24401	ASD3K20NB
		Removable in right and center	C	ASN3K20NC	ASN3K20NC-NO24401	ASD3K20NC
		Removable in center only	D	ASN3K20ND	ASN3K20ND-NO24401	ASD3K20ND
		Removable in right and left	E	ASN3K20NE	ASN3K20NE-NO24401	ASD3K20NE
		Removal in left only	G	ASN3K20NG	ASN3K20NG-NO24401	ASD3K20NG
		Removable in right only	H	ASN3K20NH	ASN3K20NH-NO24401	ASD3K20NH
	Spring return from right	Removable in left and center	(blank)	ASN31K20N	ASN31K20N-NO24401	ASD31K20N
		Removable in center only	D	ASN31K20ND	ASN31K20ND-NO24401	ASD31K20ND
		Removal in left only	G	ASN31K20NG	ASN31K20NG-NO24401	ASD31K20NG
	Spring return from left	Removable in right and center	(blank)	ASN32K20N	ASN32K20N-NO24401	ASD32K20N
		Removable in center only	D	ASN32K20ND	ASN32K20ND-NO24401	ASD32K20ND
		Removable in right only	H	ASN32K20NH	ASN32K20NH-NO24401	ASD32K20NH
Spring return two-way	Removable in center only	(blank)	ASN33K20N	ASN33K20N-NO24401	ASD33K20N	

• The key cannot be removed in spring return positions.



Download catalogs and CAD from <http://eu.idec.com/downloads>

APEM

Switches & Pilot Lights

Control Boxes

Emergency Stop Switches

Enabling Switches

Safety Products

Explosion Proof

Terminal Blocks

Relays & Sockets

Circuit Protectors

Power Supplies

LED Illumination

Controllers

Operator Interfaces

Sensors

AUTO-ID

Flush Silhouette

ø16

ø22

ø30

Miniature

Pilot Lights

TWN

TWND

ARN

CS



## Ordering Information

## Illuminated Selector Switch

When specifying gold-plated silver contact, contact configuration, and LED operating voltage:

## TWN series (B-320)

ASLN 2 16 22 DN - MAU

① Optional contact

② Contact configuration (see B-321 to B-322)

③ Operating voltage

&lt;Codes&gt;

① Optional contact

MAU: Gold-plated silver

③ Operating voltage

99: Without LED lamp

66: 6V AC/DC

11: 12V AC/DC

22: 24V AC/DC

16: 100/110V AC

136: 115/120V AC

26: 200/220V AC

256: 230/240V AC

386: 380V AC

46: 400/440V AC

486: 480V AC

Note:

- Odd number of contact blocks, such as 1N0, 1NC, 3N0, 2N0-1NC, 1N0-2NC, and 3NC, is not available for models of 100V AC or over.
  - Illuminated selector switches of 24V AC/DC and below with two or four contact blocks contain a dummy block.
  - See below for how to specify 110V DC model (DC-DC converter).
  - Color codes for units without LED lamps: R (red), G (green), A (amber), Y (yellow), S (blue)
- When using a commercially available lamp, choose a lamp with rated voltage 5 to 30V AC/DC and 1W maximum, and with the same base and shape.

## Pilot Light (LED)

When specifying LED operating voltage:

## TWN series (B-324 to B-325)

APN1 26 DN R

① Operating voltage

&lt;Codes&gt;

① Operating voltage

99: Without LED lamp

66: 6V AC/DC

11: 12V AC/DC

22: 24V AC/DC

16: 100/110V AC

126: 115/120V AC

26: 200/220V AC

246: 230/240V AC

386: 380V AC

46: 400/440V AC

486: 480V AC

UPQN3B 22 D R

① Operating voltage

## TWND series (B-336)

APD1 26 DN R

① Operating voltage

- See below for how to specify 110V DC model (DC-DC converter).

- Color codes for units without LED lamps: R (red), G (green), A (amber), Y (yellow), W (white), S (blue)

When using a commercially available lamp, choose a lamp with rated voltage 5 to 30V AC/DC and 1W maximum, and with the same base and shape.

## DC-DC Converter Model (110V DC)

When specifying DC-DC converter type on illuminated pushbuttons, illuminated selector switches, and pilot lights:

## TWN series

ALN2 16 22D DN G

① Operating voltage

&lt;Codes&gt;

① Operating voltage

16 □ D: 110V DC

ASLN2 16 11D DN Y

① Operating voltage

APN1 16 D DN R

① Operating voltage

## TWND series

ALD2 16 22D DN G

① Operating voltage

ASLD2 16 11D DN Y

① Operating voltage

APD1 16 D DN R



① Operating voltage

- See 110V DC model (DC-DC converter) is not approved by standards (operating voltage: 90 to 140V DC).

- Odd number of contact blocks, such as 1N0, 1NC, 3N0, 2N0-1NC, 1N0-2NC, and 3NC, is not available for 100V DC model (DC-DC converter).

Flush/Extended/Extended w/Half Shroud/Extended with Full Shroud

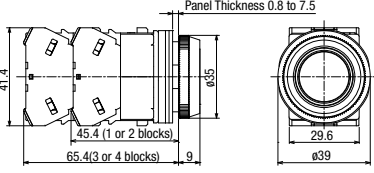
Package Quantity: 1

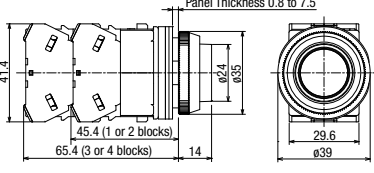
Shape	Operation	Contact	Part No. (Ordering No.)	Button Color Code	Dimensions (All dimensions in mm.)
Flush ABN1 AON1 	Momentary	1NO	ABN110*	B G R Y S W  Note	
		1NC	ABN101*		
		1NO-1NC	ABN111*		
		2NO	ABN120*		
		2NC	ABN102*		
		2NO-2NC	ABN122*		
	Maintained	1NO	AON110*	B G R Y S W  Note	
		1NC	AON101*		
		1NO-1NC	AON111*		
		2NO	AON120*		
		2NC	AON102*		
		2NO-2NC	AON122*		
Extended ABN2 AON2 	Momentary	1NO	ABN210*	B G R Y S W	
		1NC	ABN201*		
		1NO-1NC	ABN211*		
		2NO	ABN220*		
		2NC	ABN202*		
		2NO-2NC	ABN222*		
	Maintained	1NO	AON210*	B G R Y S W	
		1NC	AON201*		
		1NO-1NC	AON211*		
		2NO	AON220*		
		2NC	AON202*		
		2NO-2NC	AON222*		
Extended with Half Shroud ABN2G AON2G 	Momentary	1NO	ABN2G10*	B G R Y S W	
		1NC	ABN2G01*		
		1NO-1NC	ABN2G11*		
		2NO	ABN2G20*		
		2NC	ABN2G02*		
		2NO-2NC	ABN2G22*		
	Maintained	1NO	AON2G10*	B G R Y S W	
		1NC	AON2G01*		
		1NO-1NC	AON2G11*		
		2NO	AON2G20*		
		2NC	AON2G02*		
		2NO-2NC	AON2G22*		
Extended with Full Shroud ABN2F AON2F 	Momentary	1NO	ABN2F10*	B G R Y S W	
		1NC	ABN2F01*		
		1NO-1NC	ABN2F11*		
		2NO	ABN2F20*		
		2NC	ABN2F02*		
		2NO-2NC	ABN2F22*		
	Maintained	1NO	AON2F10*	B G R Y S W	
		1NC	AON2F01*		
		1NO-1NC	AON2F11*		
		2NO	AON2F20*		
		2NC	AON2F02*		
		2NO-2NC	AON2F22*		

- Specify a color code in place of \* in Part No. B (black), G (green), R (red), Y (yellow), S (blue), W (white)
- Round bezel and shroud (metal): Chrome-plated
- Pushbuttons with 1 or 3 contact blocks have a dummy block.
- See B-307 for other contact configurations and gold-plated silver contacts.
- See B-312 for bottom view.
- Terminal screws: M3.5
- Integrated terminal cover

**Note** ABN1, AON1 with button color of B (black), G (green), or (R) red  
 Supply of color buttons B, G, R has been discontinued for ABN1/AON1 without color code.  
 When ordering, make sure to specify the required button color code.

APEM

Switches & Pilot Lights

Control Boxes

Emergency Stop Switches

Enabling Switches

Safety Products

Explosion Proof

Terminal Blocks

Relays & Sockets

Circuit Protectors

Power Supplies

LED Illumination

Controllers

Operator Interfaces

Sensors

AUTO-ID

Flush Silhouette

ø16

ø22

ø30

Miniature

Pilot Lights

TWN







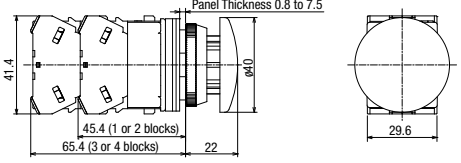

TWWD

ARN

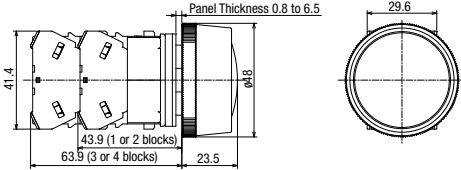
CS

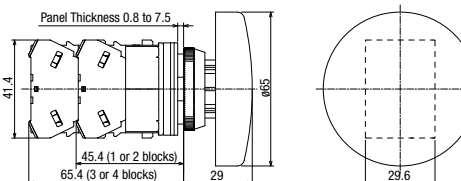
## Mushroom/Mushroom w/Full Shroud/Jumbo Mushroom/Jumbo Mushroom w/Shallow Shroud/Jumbo Mushroom w/Deep Shroud

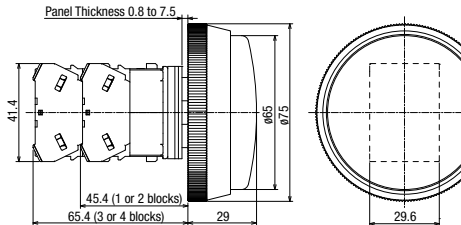
Package Quantity: 1

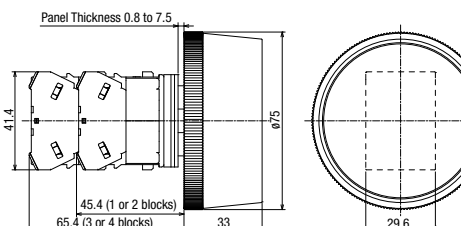



Shape	Operation	Contact	Part No. (Ordering No.)	Button Color Code	Dimensions (All dimensions in mm.)
Mushroom ABN3 AON3 	Momentary	1NO	ABN310*	B G R Y S W	
		1NC	ABN301*		
		1NO-1NC	ABN311*		
		2NO	ABN320*		
		2NC	ABN302*		
	Maintained	1NO	AON310*	B G R Y S W	
		1NC	AON301*		
		1NO-1NC	AON311*		
		2NO	AON320*		
		2NC	AON302*		
Mushroom with Full Shroud ABN3G 	Momentary	1NO	ABN3G10*	B G R Y S W	
		1NC	ABN3G01*		
		1NO-1NC	ABN3G11*		
		2NO	ABN3G20*		
		2NC	ABN3G02*		
		2NO-2NC	ABN3G22*		
Jumbo Mushroom ABN4 	Momentary	1NO	ABN410*	B G R Y	
		1NC	ABN401*		
		1NO-1NC	ABN411*		
		2NO	ABN420*		
		2NC	ABN402*		
		2NO-2NC	ABN422*		
Jumbo Mushroom with Shallow Shroud ABN4G 	Momentary	1NO	ABN4G10*	B G R Y	
		1NC	ABN4G01*		
		1NO-1NC	ABN4G11*		
		2NO	ABN4G20*		
		2NC	ABN4G02*		
		2NO-2NC	ABN4G22*		
Jumbo Mushroom with Deep Shroud ABN4F 	Momentary	1NO	ABN4F10*	B G R Y	
		1NC	ABN4F01*		
		1NO-1NC	ABN4F11*		
		2NO	ABN4F20*		
		2NC	ABN4F02*		
		2NO-2NC	ABN4F22*		

CS

- Specify a color code in place of \* in Part No. B (black), G (green), R (red), Y (yellow), S (blue), W (white)
- Round bezel and shroud (metal): Chrome-plated
- Pushbuttons with 1 or 3 contact blocks have a dummy block.
- See **B-307** for other contact configurations and gold-plated silver contacts.
- See **B-312** for bottom view.
- Terminal screws: M3.5
- Integrated terminal cover

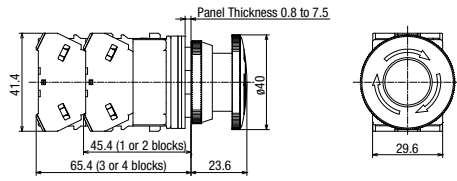
Mushroom Pushlock Turn Reset/Mushroom Push Turn Lock/Mushroom Pull

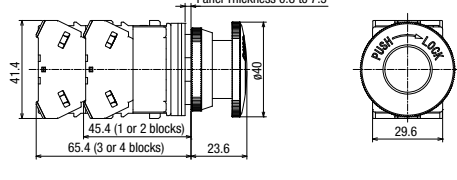
Package Quantity: 1

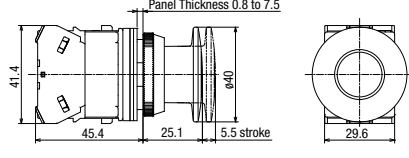
Shape	Contact	Part No. (Ordering No.)	Button Color Code	Dimensions (All dimensions in mm.)
Mushroom Pushlock Turn Reset (*1) AVN3 	1NO	AVN310N*	R Y	
	1NC	AVN301N*		
	1NO-1NC	AVN311N*		
	2NO	AVN320N*		
	2NC	AVN302N*		
Mushroom Push Turn Lock AJN3 	1NO	AJN310N*	B G R Y	
	1NC	AJN301N*		
	1NO-1NC	AJN311N*		
	2NO	AJN320N*		
	2NC	AJN302N*		
Mushroom Pull AZN3 	1NO	AZN310N*	B G R Y	
	1NC	AZN301N*		
	1NO-1NC	AZN311N*		
	2NO	AZN320N*		
	2NC	AZN302N*		

- Specify a color code in place of \* in Part No. B (black), G (green), R (red), Y (yellow)
- Round bezel (metal): Chrome-plated
- Pushbuttons with 1 or 3 contact blocks have a dummy block.
- See **B-307** for other contact configurations and gold-plated silver contacts.
- Mushroom pull has up to 2 contact blocks.
- Terminal screws: M3.5
- Integrated terminal cover

\*1) Pushlock turn reset switches cannot be used as emergency stop switches. When emergency stop switches are required, use XN series emergency stop switches (ISO 13850 and IEC 60947-5-5 compliant).

Pushbutton operation

Pushlock Turn Reset

Button is maintained when pressed and is reset when turned clockwise.

Push Turn Lock

Button is locked when turned clockwise in the depressed position and is reset when turned counterclockwise.

Pull

Pulling the button operates the contacts, and releasing the button return the contacts.

Pull contact operation

Contact	AZN3	
	Normal	Pull
1NO		
2NO-2NC		
2NO		
2NC		

Bottom View (for non-illuminated pushbuttons and selector switches)

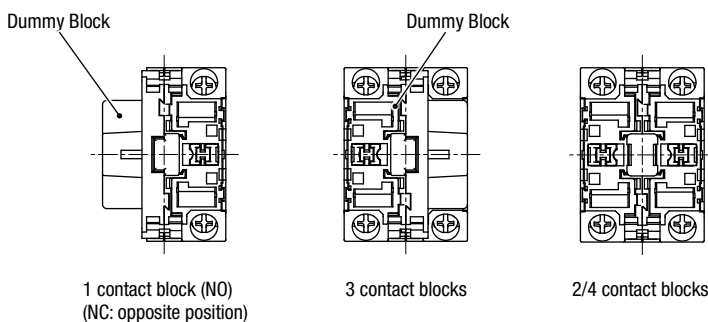

- See **B-348** for wiring.
- Integrated terminal cover

APEM

Switches & Pilot Lights

Control Boxes

Emergency Stop Switches

Enabling Switches

Safety Products

Explosion Proof

Terminal Blocks

Relays & Sockets

Circuit Protectors

Power Supplies

LED Illumination

Controllers

Operator Interfaces

Sensors

AUTO-ID

Flush Silhouette

ø16

ø22

ø30

Miniature

Pilot Lights

TWN







TWND

ARN

CS

## LED Illuminated Extended/Extended with Half Shroud/Extended with Full Shroud

Package Quantity: 1

Shape	Base	Operation	Operating Voltage	Contact	Part No. (Ordering No.)	Color Code	Dimensions Page
Extended ALN2 AOLN2   (24VAC/DC)   With transformer (100/110V AC)	BA9S	Momentary	24V AC/DC	1NO-1NC	ALN22211DN*	R G Y A S PW	B-315
				2NO	ALN22220DN*		
				2NC	ALN22202DN*		
			100/110V AC	1NO-1NC	ALN21611DN*		
				2NO	ALN21620DN*		
				2NC	ALN21602DN*		
		200/220V AC	1NO-1NC	ALN22611DN*			
			2NO	ALN22620DN*			
			2NC	ALN22602DN*			
		Maintained	24V AC/DC	1NO-1NC	AOLN22211DN*	R G Y A S PW	
				2NO	AOLN22220DN*		
				2NC	AOLN22202DN*		
100/110V AC	1NO-1NC		AOLN21611DN*				
	2NO		AOLN21620DN*				
	2NC		AOLN21602DN*				
200/220V AC	1NO-1NC	AOLN22611DN*					
	2NO	AOLN22620DN*					
	2NC	AOLN22602DN*					
Extended with Half Shroud ALGN2 AOLGN2   (24V AC/DC)   With transformer (100/110V AC)	BA9S	Momentary	24V AC/DC	1NO-1NC	ALGN22211DN*	R G Y A S PW	
				2NO	ALGN22220DN*		
				2NC	ALGN22202DN*		
			100/110V AC	1NO-1NC	ALGN21611DN*		
				2NO	ALGN21620DN*		
				2NC	ALGN21602DN*		
		200/220V AC	1NO-1NC	ALGN22611DN*			
			2NO	ALGN22620DN*			
			2NC	ALGN22602DN*			
		Maintained	24V AC/DC	1NO-1NC	AOLGN22211DN*	R G Y A S PW	
				2NO	AOLGN22220DN*		
				2NC	AOLGN22202DN*		
100/110V AC	1NO-1NC		AOLGN21611DN*				
	2NO		AOLGN21620DN*				
	2NC		AOLGN21602DN*				
200/220V AC	1NO-1NC	AOLGN22611DN*					
	2NO	AOLGN22620DN*					
	2NC	AOLGN22602DN*					
Extended with Full Shroud ALFN2 AOLFN2   (24V AC/DC)   With transformer (100/110V AC)	BA9S	Momentary	24V AC/DC	1NO-1NC	ALFN22211DN*	R G Y A S PW	
				2NO	ALFN22220DN*		
				2NC	ALFN22202DN*		
			100/110V AC	1NO-1NC	ALFN21611DN*		
				2NO	ALFN21620DN*		
				2NC	ALFN21602DN*		
		200/220V AC	1NO-1NC	ALFN22611DN*			
			2NO	ALFN22620DN*			
			2NC	ALFN22602DN*			
		Maintained	24V AC/DC	1NO-1NC	AOLFN22211DN*	R G Y A S PW	
				2NO	AOLFN22220DN*		
				2NC	AOLFN22202DN*		
100/110V AC	1NO-1NC		AOLFN21611DN*				
	2NO		AOLFN21620DN*				
	2NC		AOLFN21602DN*				
200/220V AC	1NO-1NC	AOLFN22611DN*					
	2NO	AOLFN22620DN*					
	2NC	AOLFN22602DN*					

- Specify a color code in place of \* in Part No. R (red), G (green), Y (yellow), A (amber), S (blue), PW (pure white)
- Illuminated pushbuttons have an LED lamp installed.
- Round bezel (metal): Chrome-plated
- See B-308 for other operating voltage such as 6V AC/DC, 12V AC/DC, and 110V DC.
- Illuminated pushbuttons of 24V AC/DC or below with 2 or 4 contact blocks have a dummy block.

- See B-308 for other contact configurations and gold-plated silver contacts.
- See B-314 for bottom view.
- Terminal screws: M3.5
- Integrated terminal cover



LED Illuminated Mushroom (ø40)/Mushroom Pushlock Turn Reset/Mushroom Push Turn Lock

Package Quantity: 1

Shape	Base	Operation	Operating Voltage	Contact	Part No. (Ordering No.)	Color Code	Dimensions Page
Mushroom (ø40) ALN3 AOLN3   (24V AC/DC)   With transformer (100/110V AC)	BA9S	Momentary	24V AC/DC	1NO-1NC	ALN32211DN *	R G Y A S PW	B-315
				2NO	ALN32220DN *		
				2NC	ALN32202DN *		
			100/110V AC	1NO-1NC	ALN31611DN *		
				2NO	ALN31620DN *		
				2NC	ALN31602DN *		
		200/220V AC	1NO-1NC	ALN32611DN *			
			2NO	ALN32620DN *			
			2NC	ALN32602DN *			
		Maintained	24V AC/DC	1NO-1NC	AOLN32211DN *	R G Y A S PW	
				2NO	AOLN32220DN *		
				2NC	AOLN32202DN *		
100/110V AC	1NO-1NC		AOLN31611DN *				
	2NO		AOLN31620DN *				
	2NC		AOLN31602DN *				
200/220V AC	1NO-1NC	AOLN32611DN *					
	2NO	AOLN32620DN *					
	2NC	AOLN32602DN *					
Mushroom Pushlock Turn Reset AVLN3 (*1)	BA9S	—	24V AC/DC	1NO-1NC	AVLN32211DN *	R	
				2NO	AVLN32220DN *		
				2NC	AVLN32202DN *		
			100/110V AC	1NO-1NC	AVLN31611DN *		
				2NO	AVLN31620DN *		
				2NC	AVLN31602DN *		
			200/220V AC	1NO-1NC	AVLN32611DN *		
				2NO	AVLN32620DN *		
				2NC	AVLN32602DN *		
Mushroom Push Turn Lock AJLN3	BA9S	—	24V AC/DC	1NO-1NC	AJLN32211DN *	R G Y A PW	
				2NO	AJLN32220DN *		
				2NC	AJLN32202DN *		
			100/110V AC	1NO-1NC	AJLN31611DN *		
				2NO	AJLN31620DN *		
				2NC	AJLN31602DN *		
			200/220V AC	1NO-1NC	AJLN32611DN *		
				2NO	AJLN32620DN *		
				2NC	AJLN32602DN *		

- Specify a color code in place of \* in Part No. R (red), G (green), Y (yellow), A (amber), S (blue), PW (pure white)
- Illuminated pushbuttons have an LED lamp installed.
- Round bezel (metal): Chrome-plated
- See B-308 for other operating voltage such as 6V AC/DC, 12V AC/DC, and 110V DC.
- See B-308 for other contact configurations and gold-plated silver contacts.
- Illuminated pushbuttons of 24V AC/DC or below with 2 or 4 contact blocks have a dummy block.

- \*1) Pushlock turn reset switches cannot be used as emergency stop switches. When emergency stop switches are required, use XN or HN series emergency stop switches (ISO 13850 and IEC 60947-5-5 compliant).
- Terminal screws: M3.5
- Integrated terminal cover

Illuminated pushbutton operation

Pushlock Turn Reset

Button is maintained when pressed and is reset when turned clockwise.

Push Turn Lock

Button is locked when turned clockwise in the depressed position and is reset when turned counterclockwise.

Bottom View (for illuminated pushbuttons, selector switches, and pilot lights)

6V, 12V, 24V AC/DC

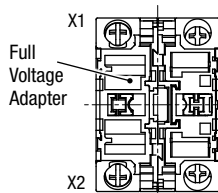

1 contact block

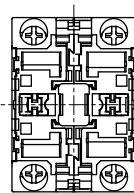

3 contact blocks

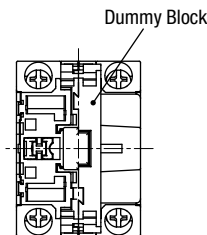

2/4 contact blocks

100/110V, 200/220V AC  
240V AC or below

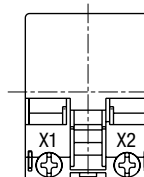

110V DC, 380V AC or over

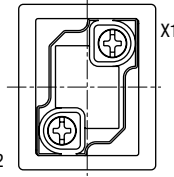

DC-DC converter unit  
Terminal No. X1: positive  
Terminal No. X2: negative

- See B-348 for wiring.

## ø30 TWN Series

## Dimensions (Illuminated Pushbuttons)

All dimensions in mm.

## Extended, LED illuminated (momentary/maintained)

ALN2/AOLN2 (terminal screws M3.5) Integrated terminal cover

6, 12, 24V AC/DC - Without LED Lamp

100/110V AC, 200/220V AC (240V AC or below)

110V DC/380V AC or over

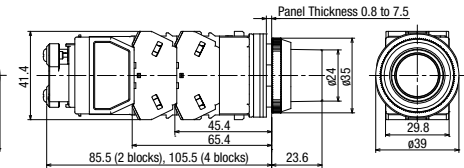
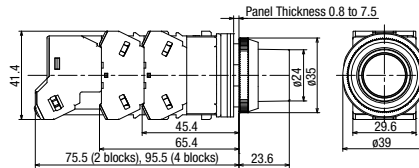
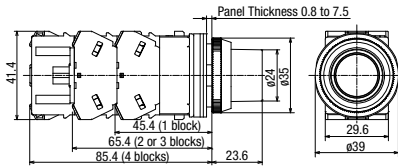

## Extended with Half Shroud, LED illuminated (momentary/maintained)

ALGN2/AOLGN2 (terminal screws M3.5) Integrated terminal cover

6, 12, 24V AC/DC - Without LED Lamp

100/110V AC, 200/220V AC (240V AC or below)

110V DC/380V AC or over

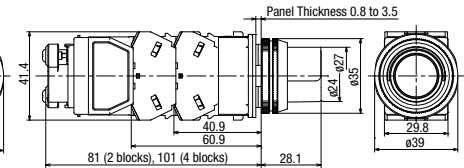
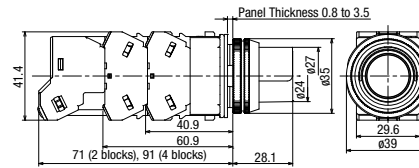
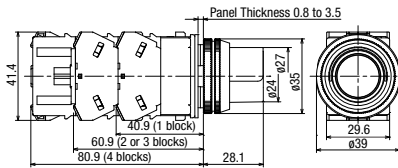

## Extended with Full Shroud, LED illuminated (momentary/maintained)

ALFN2/AOLFN2 (terminal screws M3.5) Integrated terminal cover

6, 12, 24V AC/DC - Without LED Lamp

100/110V AC, 200/220V AC (240V AC or below)

110V DC/380V AC or over

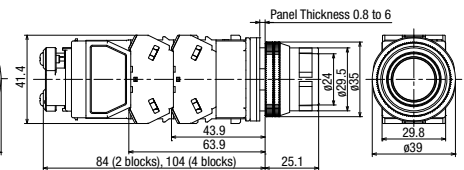
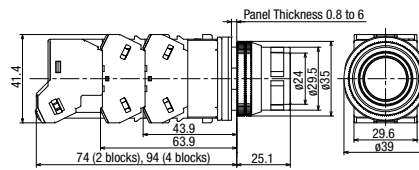
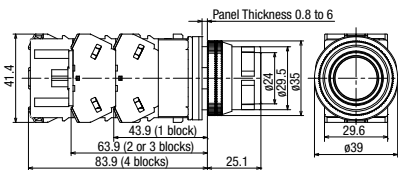

## Mushroom (ø40), LED illuminated (momentary/maintained)

ALN3/AOLN3 (terminal screws M3.5) Integrated terminal cover

6, 12, 24V AC/DC - Without LED Lamp

100/110V AC, 200/220V AC (240V AC or below)

110V DC/380V AC or over

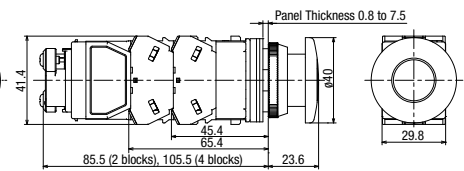
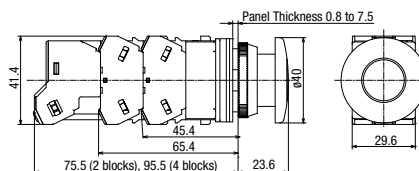
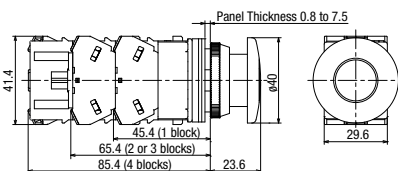

## Mushroom Pushlock Turn Reset, LED illuminated

AVLN3 (terminal screws M3.5) Integrated terminal cover

6, 12, 24V AC/DC - Without LED Lamp

100/110V AC, 200/220V AC

110V DC/380V AC or over

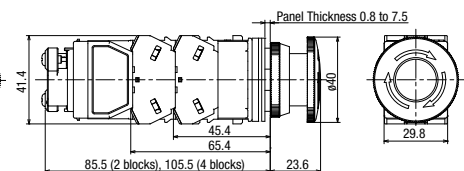
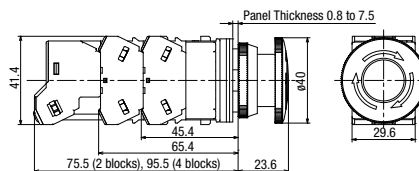
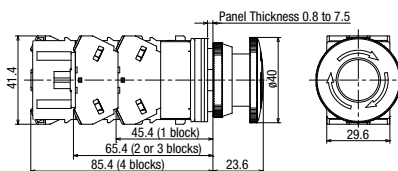

## Mushroom Push Turn Lock, LED illuminated

AJLN3 (terminal screws M3.5) Integrated terminal cover

6, 12, 24V AC/DC - Without LED Lamp

100/110V AC, 200/220V AC

110V DC/380V AC or over

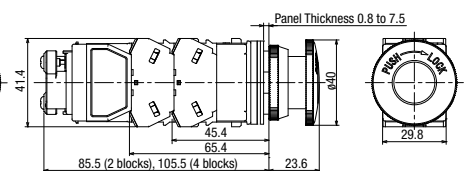
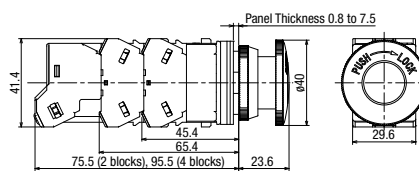
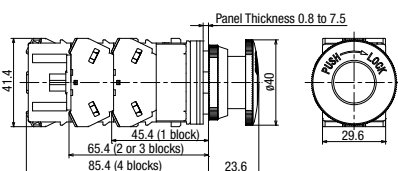

ASN Selector Switches (Knob Operator)

Package Quantity: 1

Shape	Knob Operator ASN										
	Contact Configuration		Maintained	Spring Return from Right	Spring Return from Left						
90° 2-position	Contact	Contact Block		Operator Position		1	2	Contact Block		Operator Position	
		Mounting Position	Contact	1	2			Mounting Position	Contact	1	2
90° 2-position	1NO (10)	①	NO		●	ASN210N	ASN2110N	①	NO	●	ASN2210N
		②	—	Dummy Block				②	—	—	
	1NO-1NC (11)	①	NO		●	ASN211N	ASN2111N	①	NO	●	ASN2211N
		②	NC	●				②	NC		
	2NO (20)	①	NO		●	ASN220N	ASN2120N	①	NO	●	ASN2220N
		②	NO		●			②	NO		
	2NO-2NC (22)	①	NO		●	ASN222N	ASN2122N	①	NO	●	ASN2222N
		②	NC	●				②	NC		
③		NO		●	③			NO	●		
④		NC	●		④			NC		●	
45° 3-position	2NO (20)	①	NO	●		ASN320N	ASN3120N	ASN3220N		ASN3320N	
		②	NO		●			ASN3202N			
	2NC (02)	①	NC		●	ASN302N	ASN3102N	ASN3202N		ASN3302N	
		②	NC		●			ASN3222N			
	2NO-2NC (22)	①	NO	●		ASN322N	ASN3122N	ASN3222N		ASN3322N	
		②	NO		●			ASN3240N			
		③	NC		●			ASN3204N			
		④	NC		●			ASN3304N			
	4NO (40)	①	NO	●		ASN340N	ASN3140N	ASN3240N		ASN3340N	
		②	NO		●			ASN3204N			
		③	NO	●				ASN3304N			
		④	NO		●			ASN3304N			
	4NC (04)	①	NC		●	ASN304N	ASN3104N	ASN3204N		ASN3304N	
		②	NC		●			ASN3204N			
		③	NC		●			ASN3204N			
		④	NC		●			ASN3204N			
☆ 3S	①	NO	●		ASN33SN-243 ☆	—	—		—		
	②	NO		●			—				
	③	NC		●			—				
	④	—	Dummy Block				—				

- Knob: Black
- Round bezel (metal): Chrome-plated
- Selector switches with 1 or 3 contact blocks have a dummy block.
- Knob operator can be installed at 45-degree intervals in addition to the positions shown in the above table.
- See B-321 to B-322 for other contact configurations. Turn the operator to each position accurately.

- Selector switches with ☆ have a half contact operating current (load switching current value). Rated insulation voltage and rated current remain the same.
- See B-308 for gold-plated silver contacts.
- See B-312 for bottom view.

Contact Block Mounting Position



Dimensions

All dimensions in mm.

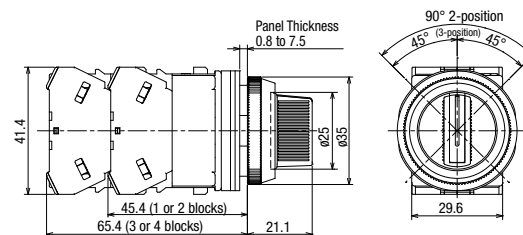

Terminal Screws: M3.5 Terminal cover: integrated

APEM

Switches & Pilot Lights

Control Boxes

Emergency Stop Switches

Enabling Switches

Safety Products

Explosion Proof

Terminal Blocks

Relays & Sockets

Circuit Protectors

Power Supplies

LED Illumination

Controllers

Operator Interfaces

Sensors

AUTO-ID

Flush Silhouette

ø16

ø22

ø30

Miniature

Pilot Lights

TWN

TWWD

ARN

CS

## ASN-□ Selector Switches (Lever Operator)

Package Quantity: 1

Shape	Lever Operator ASN□L										
	Contact Configuration		Maintained	Spring Return from Right	Spring Return from Left						
Contact	Contact Block	Operator Position	1	2	1	2	Contact Block	Operator Position	1	2	
											Mounting Position
90° 2-position	1NO (10)	①	NO	●			①	NO	●		
		②	—			Dummy Block	②	—			
	1NO-1NC (11)	①	NO		●			①	NO	●	
		②	NC	●				②	NC		●
	2NO (20)	①	NO		●			①	NO	●	
		②	NO		●			②	NO	●	
	2NO-2NC (22)	①	NO		●			①	NO	●	
		②	NC	●				②	NC		●
		③	NO		●			③	NO	●	
		④	NC	●				④	NC		●
	45° 3-position	2NO (20)	①	NO	●						
			②	NO			●				
2NC (02)		①	NO			●					
		②	NO	●							
2NO-2NC (22)		①	NO			●					
		②	NO				●				
		③	NO	●							
		④	NO			●					
4NO (40)		①	NO	●							
		②	NO				●				
		③	NO	●							
		④	NO				●				
4NC (04)		①	NO			●					
		②	NO	●							
		③	NO				●				
		④	NO					●			
☆ 3S		①	NO	●							
		②	NO				●				
		③	NO					●			
		④	—								
		Dummy Block									

ARN

- Lever: Black
- Round bezel (metal): Chrome-plated
- Selector switches with 1 or 3 contact blocks have a dummy block.
- Knob operator can be installed at 45-degree intervals in addition to the positions shown in the above table.
- See **B-321** to **B-322** for other contact configurations.
- Turn the operator to each position accurately.

- Selector switches with ☆ have a half contact operating current (load switching current value). Rated insulation voltage and rated current remain the same.
- See **B-308** for gold contact.
- See **B-312** for bottom view.

## Contact Block Mounting Position

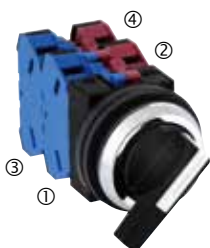

## Dimensions

All dimensions in mm.

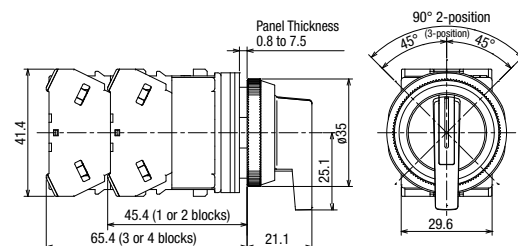

Terminal Screws: M3.5

Terminal cover: integrated

For more information, visit <http://eu.idec.com>

## ASN-□K Key Selector Switches

Package Quantity: 1

Shape	Key Selector (Key No. 0) ASN□K													
	Contact Configuration					Maintained 1 2	Spring Return from Right 1 2	Spring Return from Left						
	Contact	Contact Block		Operator Position				Contact Block	Operator Position	Contact Block		Operator Position		
Mounting Position		Contact	1	2	Mounting Position	Contact	1			2				
90° 2-position	1NO (10)	①	NO		●	ASN2K10N	ASN21K10N	①	NO	●	ASN22K10N			
		②	—	Dummy Block					②	—		—		
	1NO-1NC (11)	①	NO		●	ASN2K11N	ASN21K11N	①	NO	●	ASN22K11N			
		②	NC	●				②	NC			●		
	2NO (20)	①	NO		●	ASN2K20N	ASN21K20N	①	NO	●	ASN22K20N			
		②	NO		●			②	NO	●				
	2NO-2NC (22)	①	NO		●	ASN2K22N	ASN21K22N	①	NO	●	ASN22K22N			
		②	NC	●				②	NC			●		
		③	NO		●			③	NO	●				
		④	NC	●				④	NC			●		
	45° 3-position	2NO (20)	①	NO	●		ASN3K20N	ASN31K20N	①	NO	●	ASN32K20N	ASN33K20N	
			②	NO		●				②	NO			
2NC (02)		①	NC		●	ASN3K02N	ASN31K02N	①	NC		ASN32K02N	ASN33K02N		
		②	NC		●				②	NC				●
2NO-2NC (22)		①	NO	●		ASN3K22N	ASN31K22N	①	NO	●	ASN32K22N	ASN33K22N		
		②	NO		●				②	NO				●
		③	NC		●				③	NC				●
		④	NC		●				④	NC				●
4NO (40)		①	NO	●		ASN3K40N	ASN31K40N	①	NO	●	ASN32K40N	ASN33K40N		
		②	NO		●				②	NO				●
		③	NO	●					③	NO			●	
		④	NO		●				④	NO				●
4NC (04)		①	NC		●	ASN3K04N	ASN31K04N	①	NC		ASN32K04N	ASN33K04N		
		②	NC		●				②	NC				●
		③	NC		●				③	NC				●
		④	NC		●				④	NC				●
☆ 3S		①	NO	●		ASN3K3SN-243	—	①	NO	●	—	—		
		②	NO		●				②	NO				●
		③	NC		●				③	NC				●
		④	—	Dummy Block					④	—			—	

- Cylinder: Chrome-plated
- Round bezel (metal): Chrome-plated
- Key selector switches with 1 or 3 contact blocks have a dummy block.
- See B-321 to B-322 for other contact configurations.
- On spring-returned types, the key can be released only from the maintained position. On maintained types, the key can be released from every position. See B-308 for specifying key retained positions.

- Key selector switch is supplied with two standard keys.
  - (1) Insert the key completely before turning the key, otherwise failure may result.
  - (2) Turn the operator to each position accurately.
- Different key number is available upon request. Contact IDEC.
- Selector switches with ☆ have a half contact operating current (load switching current value). Rated insulation voltage and rated current remain the same.
- See B-308 for gold-plated silver contacts.
- See B-312 for bottom view.

### Contact Block Mounting Position

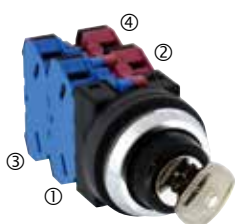

### Dimensions

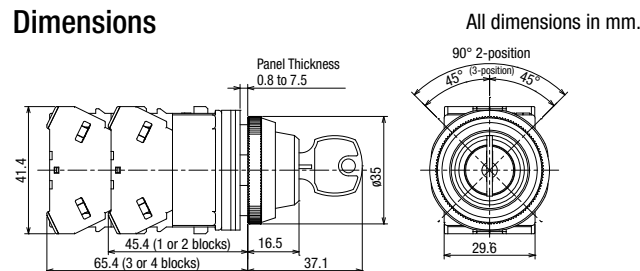

Terminal Screws: M3.5 Terminal cover: integrated



## ASN-□K Key Selector Switches

Package Quantity: 1

Shape	Key Selector (Key No. 24401) ASN□K												
	Contact Configuration					Maintained	Spring Return from Right	Spring Return from Left					
	Contact	Contact Block		Operator Position		1 2	1 2	Contact Block		Operator Position		1 2	
Mounting Position		Contact	1	2	Mounting Position			Contact	1	2			
90° 2-position	1NO (10)	①	NO		●	ASN2K10N- NO24401	ASN21K10N- NO24401	①	NO	●	ASN22K10N- NO24401		
		②	—	Dummy Block				②	—	—			
	1NO-1NC (11)	①	NO		●	ASN2K11N- NO24401	ASN21K11N- NO24401	①	NO	●	ASN22K11N- NO24401		
		②	NC	●				②	NC			●	
	2NO (20)	①	NO		●	ASN2K20N- NO24401	ASN21K20N- NO24401	①	NO	●	ASN22K20N- NO24401		
		②	NO		●			②	NO	●			
	2NO-2NC (22)	①	NO		●	ASN2K22N- NO24401	ASN21K22N- NO24401	①	NO	●	ASN22K22N- NO24401		
		②	NC	●				②	NC	●		●	
		③	NO		●			③	NO	●			
		④	NC	●				④	NC			●	
	45° 3-position	2NO (20)	①	NO	●		ASN3K20N- NO24401	ASN31K20N- NO24401	ASN32K20N- NO24401	ASN33K20N- NO24401			
			②	NO		●					②	NO	
2NC (02)		①	NC		●	ASN3K02N- NO24401	ASN31K02N- NO24401	ASN32K02N- NO24401	ASN33K02N- NO24401				
		②	NC	●						②	NC	●	
2NO-2NC (22)		①	NO	●		ASN3K22N- NO24401	ASN31K22N- NO24401	ASN32K22N- NO24401	ASN33K22N- NO24401				
		②	NO		●					②	NO		●
		③	NC		●					③	NC		●
		④	NC	●						④	NC	●	
4NO (40)		①	NO	●		ASN3K40N- NO24401	ASN31K40N- NO24401	ASN32K40N- NO24401	ASN33K40N- NO24401				
		②	NO		●					②	NO		●
		③	NO	●						③	NO	●	
		④	NO		●					④	NO		●
4NC (04)		①	NC		●	ASN3K04N- NO24401	ASN31K04N- NO24401	ASN32K04N- NO24401	ASN33K04N- NO24401				
		②	NC	●						②	NC	●	
		③	NC		●					③	NC		●
		④	NC	●						④	NC	●	
☆ 3S		①	NO	●		ASN3K3SN- 243-NO24401	—	—	—				
		②	NO		●					②	NO		●
		③	NC		●					③	NC		●
		④	—	Dummy Block						④	—	Dummy Block	

ARN

- Cylinder: Chrome-plated
- Round bezel (metal): Chrome-plated
- Key selector switches with 1 or 3 contact blocks have a dummy block.
- See B-321 to B-322 for other contact configurations.
- On spring-returned types, the key can be released only from the maintained position. On maintained types, the key can be released from every position. See B-308 for specifying key retained positions.

- Key selector switch is supplied with two standard keys.
  - (1) Insert the key completely before turning the key, otherwise failure may result.
  - (2) Turn the operator to each position accurately.
- Different key number is available upon request. Contact IDEC.
- Selector switches with ☆ have a half contact operating current (load switching current value). Rated insulation voltage and rated current remain the same.
- See B-308 for gold-plated silver contacts.
- See B-312 for bottom view.

## Contact Block Mounting Position

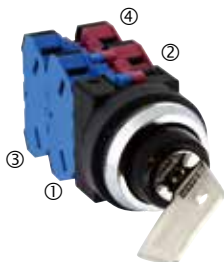

## Dimensions

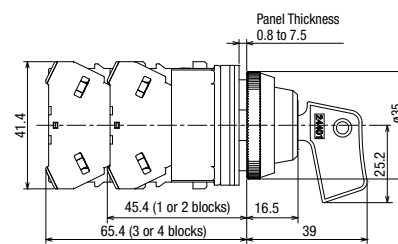

Terminal Screws: M3.5

All dimensions in mm.

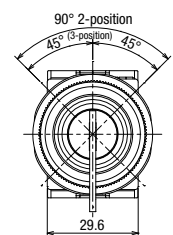

Terminal cover: integrated

For more information, visit <http://eu.idec.com>

ASLN Illuminated Selector Switches (LED)

Package Quantity: 1

Shape	Illuminated Selector Switches (BA9S Base) ASLN										Color Code		
	Contact Configuration					Rated Voltage	Maintained	Spring Return from Right	Spring Return from Left				
	Contact	Contact Block		Operator Position			1	2	1	2		1	2
90° 2-position	1NO-1NC (11)	①	NO	●	●	24V AC/DC	ASLN22211DN*	ASLN212211DN*	①	NO	●	●	ASLN222211DN*
		②	NC	●	●	100/110V AC	ASLN21611DN*	ASLN211611DN*	②	NC	●	●	ASLN221611DN*
						200/220V AC	ASLN22611DN*	ASLN212611DN*					ASLN222611DN*
	2NO (20)	①	NO	●	●	24V AC/DC	ASLN22220DN*	ASLN212220DN*	①	NO	●	●	ASLN222220DN*
		②	NO	●	●	100/110V AC	ASLN21620DN*	ASLN211620DN*	②	NO	●	●	ASLN221620DN*
						200/220V AC	ASLN22620DN*	ASLN212620DN*					ASLN222620DN*
	2NO-2NC (22)	①	NO	●	●	24V AC/DC	ASLN22222DN*	ASLN212222DN*	①	NO	●	●	ASLN222222DN*
		②	NC	●	●	100/110V AC	ASLN21622DN*	ASLN211622DN*	②	NC	●	●	ASLN221622DN*
		③	NO	●	●	200/220V AC	ASLN22622DN*	ASLN212622DN*	③	NO	●	●	ASLN222622DN*
		④	NC	●	●	—	—	—	④	NC	●	●	—
	45° 3-position	2NO (20)	①	NO	●	●	24V AC/DC	ASLN32220DN*	ASLN312220DN*	ASLN32220DN*	ASLN332220DN*		
			②	NO	●	●	100/110V AC	ASLN31620DN*	ASLN311620DN*	ASLN321620DN*	ASLN331620DN*		
						200/220V AC	ASLN32620DN*	ASLN312620DN*	ASLN322620DN*	ASLN332620DN*			
2NC (02)		①	NC	●	●	24V AC/DC	ASLN32202DN*	ASLN312202DN*	ASLN322202DN*	ASLN332202DN*			
		②	NC	●	●	100/110V AC	ASLN31602DN*	ASLN311602DN*	ASLN321602DN*	ASLN331602DN*			
						200/220V AC	ASLN32602DN*	ASLN312602DN*	ASLN322602DN*	ASLN332602DN*			
2NO-2NC (22)		①	NO	●	●	24V AC/DC	ASLN32222DN*	ASLN312222DN*	ASLN322222DN*	ASLN332222DN*			
		②	NO	●	●	100/110V AC	ASLN31622DN*	ASLN311622DN*	ASLN321622DN*	ASLN331622DN*			
		③	NC	●	●	200/220V AC	ASLN32622DN*	ASLN312622DN*	ASLN322622DN*	ASLN332622DN*			
		④	NC	●	●	—	—	—	—	—			
4NO (40)		①	NO	●	●	24V AC/DC	ASLN32240DN*	ASLN312240DN*	ASLN322240DN*	ASLN332240DN*			
		②	NO	●	●	100/110V AC	ASLN31640DN*	ASLN311640DN*	ASLN321640DN*	ASLN331640DN*			
		③	NO	●	●	200/220V AC	ASLN32640DN*	ASLN312640DN*	ASLN322640DN*	ASLN332640DN*			
		④	NO	●	●	—	—	—	—	—			
4NC (04)		①	NC	●	●	24V AC/DC	ASLN32204DN*	ASLN312204DN*	ASLN322204DN*	ASLN332204DN*			
		②	NC	●	●	100/110V AC	ASLN31604DN*	ASLN311604DN*	ASLN321604DN*	ASLN331604DN*			
		③	NC	●	●	200/220V AC	ASLN32604DN*	ASLN312604DN*	ASLN322604DN*	ASLN332604DN*			
		④	NC	●	●	—	—	—	—	—			

- Specify a color code in place of \* in Part No.  
R (red), G (green), Y (yellow), A (amber), S (blue), PW (pure white)
- Illuminated selector switches have an LED lamp installed.
- Round bezel (metal): chrome-plated
- See B-309 for other operating voltage such as 6V AC/DC, 12V AC/DC, and 110V DC.
- Illuminated selector switches of 24V AC/DC or below with 2 or 4 contact blocks have a dummy block.

- See B-321 to B-322 other contact configurations.
- Turn the operator to each position accurately.
- See B-309 for gold-plated silver contacts.
- See B-314 for bottom view.

Contact Block Mounting Position

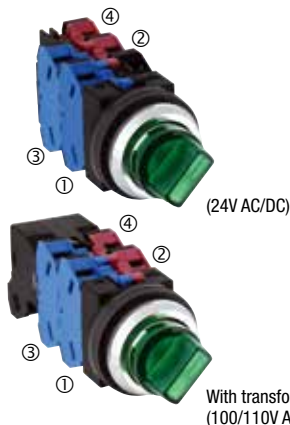

Dimensions

6, 12, 24V AC/DC  
Without LED Lamp

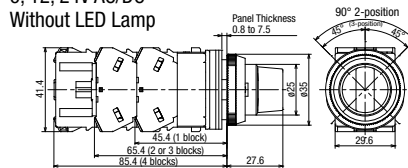

100/110V AC, 200/220V AC  
(240V AC or below)

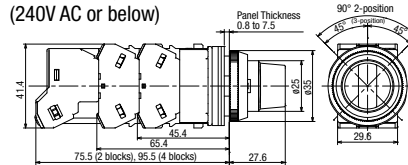

110V DC  
380V AC or over

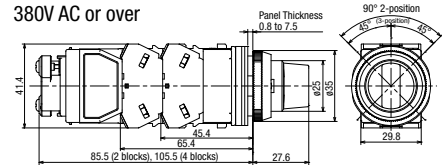

Terminal Screws: M3.5 Terminal cover: integrated

All dimensions in mm.

APEM

Switches & Pilot Lights

Control Boxes

Emergency Stop Switches

Enabling Switches

Safety Products

Explosion Proof

Terminal Blocks

Relays & Sockets

Circuit Protectors

Power Supplies

LED Illumination

Controllers

Operator Interfaces

Sensors

AUTO-ID

Flush Silhouette

ø16

ø22

ø30

Miniature

Pilot Lights

R  
G  
Y  
A  
S  
PW

R  
G  
Y  
A  
S  
PW

R  
G  
Y  
A  
S  
PW

R  
G  
Y  
A  
S  
PW

R  
G  
Y  
A  
S  
PW

R  
G  
Y  
A  
S  
PW

R  
G  
Y  
A  
S  
PW

R  
G  
Y  
A  
S  
PW

R  
G  
Y  
A  
S  
PW

R  
G  
Y  
A  
S  
PW

R  
G  
Y  
A  
S  
PW

R  
G  
Y  
A  
S  
PW

R  
G  
Y  
A  
S  
PW

R  
G  
Y  
A  
S  
PW

R  
G  
Y  
A  
S  
PW

R  
G  
Y  
A  
S  
PW

R  
G  
Y  
A  
S  
PW

R  
G  
Y  
A  
S  
PW

R  
G  
Y  
A  
S  
PW

R  
G  
Y  
A  
S  
PW

R  
G  
Y  
A  
S  
PW

R  
G  
Y  
A  
S  
PW

R  
G  
Y  
A  
S  
PW

R  
G  
Y  
A  
S  
PW

R  
G  
Y  
A  
S  
PW

R  
G  
Y  
A  
S  
PW

R  
G  
Y  
A  
S  
PW

R  
G  
Y  
A  
S  
PW

R  
G  
Y  
A  
S  
PW

## Selector Switches Contact Configuration (90° 2-position)

Contact Configuration	Circuit Code	Contact Block		Operator Operation and Circuit					
				Maintained		Spring Return from Right		Spring Return from Left	
				1 2		1 2		1 2	
				Knob Lever	Key	Knob Lever	Key	Knob Lever	Key
Mounting Position	Contact	Operator Position		Operator Position		Operator Position			
		1	2	1	2	1	2		
10	Not required	①	NO		●		●	●	
		②	—	Dummy Block		Dummy Block		Dummy Block	
01	Not required	①	NC	●		●			●
		②	—	Dummy Block		Dummy Block		Dummy Block	
2R	☆ 118	①	EM	■		■		/	
		②	LB	■		■			
	☆ 168	①	EM	/		/		■	
		②	LB					■	

Contact Configuration	Circuit Code	Contact Block		Operator Operation and Circuit								
				Maintained			Spring Return from Right			Spring Return from Left		
				1 2			1 2			1 2		
				Knob Lever	Key	Illuminated	Knob Lever	Key	Illuminated	Knob Lever	Key	Illuminated
Mounting Position	Contact	Operator Position			Operator Position			Operator Position				
		1	2		1	2		1	2			
11	Not required	①	NO		●		●	●				
		②	NC	●		●			●			
20	Not required	①	NO		●		●	●				
		②	NO		●		●	●				
02	Not required	①	NC	●		●			●			
		②	NC	●		●			●			
22	Not required	①	NO		●		●	●				
		②	NC	●		●			●			
		③	NO		●		●	●				
		④	NC	●		●			●			
31	107	①	NC	●		●			●			
		②	NO		●		●	●				
		③	NO		●		●	●				
		④	NO		●		●	●				
40	Not required	①	NO		●		●	●				
		②	NO		●		●	●				
		③	NO		●		●	●				
		④	NO		●		●	●				

• Selector switches with ☆ have a half contact operating current (load switching current value). Rated insulation voltage and rated current remain the same.

## Contact Block Mounting Position

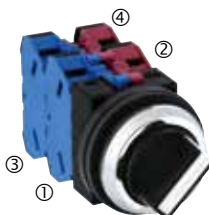

## Part No. Development

ASN 2 L 31 N - 107

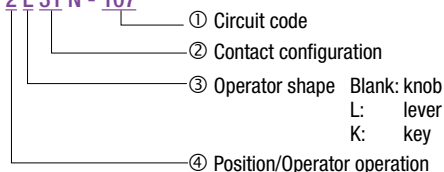

Blank: knob  
L: lever  
K: key  
2: 2-position, maintained  
21: 2-position, spring return from right  
22: 2-position, spring return from left

Selector Switches Contact Configuration (45° 3-position)

Contact Configuration	Circuit Code	Contact Block		Operator Position			Operator Operation and Circuit											
		Mounting Position	Contact	1	0	2	Maintained			Spring Return from Right			Spring Return from Left			Spring Return Two-way		
							Knob/Lever	Key	Illuminated	Knob/Lever	Key	Illuminated	Knob/Lever	Key	Illuminated	Knob/Lever	Key	Illuminated
11	202	①	NO	●			√			√			√			√		
		②	NC		■													
	203	①	NC			■	√			√			√			√		
		②	NO			●												
	303	①	NC			●	√			√			√			√		
		②	NO															
20	Not required	①	NO	●			√			√			√			√		
02	Not required	①	NC			■	√			√			√			√		
		②	NC		■													
22	Not required	①	NO	●			√			√			√			√		
		②	NO			●												
		③	NC			■	√			√			√			√		
		④	NC		■													
	209	①	NO	●				√			√			—		—		
		②	NC		■													
		③	NC			■												
		④	NO			●												
	210	①	NC			■	√			√			√			√		
		②	NO			●												
		③	NC			■												
		④	NO			●												
	310	①	NC			●	√			—			—		—		—	
		②	NO															
		③	NC			●												
		④	NO															
	311	①	NO	●				√			√			√		√		
		②	NO				●											
③		NC			●													
④		NC		■														
40	Not required	①	NO	●			√			√			√		√			
		②	NO			●												
		③	NO	●														
		④	NO			●												
04	Not required	①	NC			■	√			√			√		√			
		②	NC		■													
		③	NC			■												
		④	NC		■													
3S	☆ 243	①	NO	●			√			—			—		—			
		②	NO			●												
		③	NC			●												
		④					Dummy Block											

- Selector switches with ☆ have a half contact operating current (load switching current value). Rated insulation voltage and rated current remain the same.
- On selector switches with ☆, the contact blocks may overlap each other while turning the ring or lever operator.

Contact Block Mounting Position

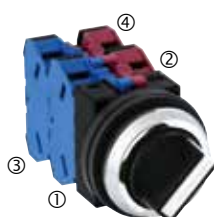

Part No. Development

ASN 3 L 22 N - 209

- ① Circuit code
- ② Contact configuration
- ③ Operator shape Blank: knob  
L: lever  
K: key
- ④ Position/Operator operation

- 3: 3-position, maintained
- 31: 3-position, spring return from right
- 32: 3-position, spring return from left
- 33: 3-position, spring return two-way

- APEM
- Switches & Pilot Lights
- Control Boxes
- Emergency Stop Switches
- Enabling Switches
- Safety Products
- Explosion Proof
- Terminal Blocks
- Relays & Sockets
- Circuit Protectors
- Power Supplies
- LED Illumination
- Controllers
- Operator Interfaces
- Sensors
- AUTO-ID
- Flush Silhouette
- ø16
- ø22
- ø30
- Miniature
- Pilot Lights
- TWN
- TWND
- ARN
- CS

## ASBN2 Selector Pushbuttons

Shape	Contact Configuration	Circuit Code	Contact Block		Ring Position				Button Color Code	Ring Operator	
					Left	Right	Pushbutton			Part No. (Ordering No.)	
			Mounting Position	Contact	Normal	Push	Normal	Push			
	11 (1NO-1NC)	A03	①	NO		●		●	B G R Y	ASBN211N-A03*	
			②	NC	●					☆ ASBN211N-K04*	
		☆ K04	①	NC	●					☆ ASBN211N-K04*	
			②	EM		●	■			☆ ASBN211N-G03*	
		G03	①	NO		●				Blocked	☆ ASBN211N-G03*
			②	NC	●		●				ASBN220N-D01*
	20 (2NO)	D01	①	NO		●			ASBN220N-D01*		
			②	NO				●			
		22 (2NO-2NC)	A08	①	NO		●		●	B G R Y	ASBN222N-A08*
				②	NC	●					
				③	NO		●		●		
				④	NC	●					
			☆ C10	①	NO		●		●		☆ ASBN222N-C10*
				②	NO				●		
				③	NC	●					
				④	NC	■					
			D10	①	NO		●				ASBN222N-D10*
				②	NO				●		
				③	NC	●		■			
				④	NC	■		●			
		☆ E10	①	NO		●			☆ ASBN222N-E10*		
			②	NO				●			
			③	NC			■				
			④	NC	■						
☆ F10		①	NO				●	☆ ASBN222N-F10*			
		②	NO		●						
		③	NC			●					
		④	NC	●							
G10		①	NO		●			ASBN222N-G10*			
		②	NO		●						
		③	NC	●			●				
		④	NC	●		●					
☆ K15	①	NC	●				☆ ASBN222N-K15*				
	②	NC	●								
	③	EM		●	■						
	④	EM		●	■						

TWN

- Specify a color code in place of \* in Part No.  
B (black), G (green), R (red), Y (yellow)

TWN D

- Bezel (metal): Chrome-plated

ARN

- Circuit code G: The pushbutton does not operate when the ring operator is turned to the right position.

CS

- Circuit codes E and F: The right and left NC contact blocks on circuit code E or F may overlap each other while turning the ring operator. The NO and NC contact blocks on circuit code F may overlap each other while pressing the button.

- When using the selector pushbutton, do not turn the ring operator with the pushbutton depressed. Otherwise, damage or failure may be caused.

- Selector switches with ☆ have a half contact operating current (load switching current value). Rated insulation voltage and rated current remain the same.

- See B-312 for bottom view.

## Contact Block Mounting Position

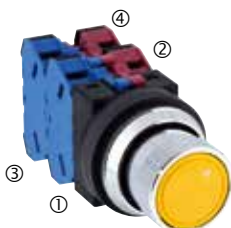

## Dimensions

## Ring operator (90° 2-position)

(All dimensions in mm.)

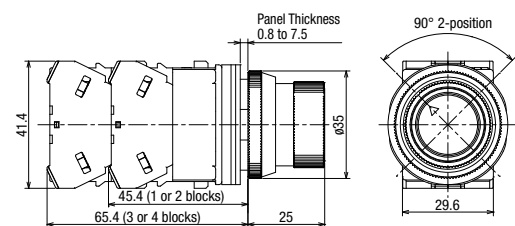



Terminal Screws: M3.5

Terminal cover: integrated



Pilot Lights Round, Square Extended, Rectangular (Marking)

Package Quantity: 1

Shape	Illumination	Base	Rated Voltage	Part No. (Ordering No.)	Color Code	LED Lamp Part No.	Dimensions Page
Round APN1  (24V AC/DC)	LED	BA9S	24V AC/DC	APN122DN*	R, G, Y, A, S, PW	LSRD-2	B-325
			100/110V AC	APN116DN*	R, G, Y, A, S, PW	LSRD-6	
			200/220V AC	APN126DN*	R, G, Y, A, S, PW		
Square Extended UPQN3B  (24V AC/DC)	LED	BA9S	24V AC/DC	UPQN3B22D*	R, G, Y, A, S, PW	LSRD-2	
			100/110V AC	UPQN3B16D*	R, G, Y, A, S, PW	LSRD-6	
			200/220V AC	UPQN3B26D*	R, G, Y, A, S, PW		
Rectangular (Marking) UPQN4  (24V AC/DC)	LED	BA9S	24V AC/DC	UPQN422D*	R, G, Y, A, S, PW	LSRD-2	
			100/110V AC	UPQN416D*	R, G, Y, A, S, PW	LSRD-6	
			200/220V AC	UPQN426D*	R, G, Y, A, S, PW		

- Specify a color code in place of \* in Part No.  
R (red), G (green), Y (yellow), A (amber), S (blue), PW (pure white)
- Round bezel (metal): chrome-plated
- Square bezel (metal): chrome-plated
- Pilot lights have an LED lamp installed.
- On the rectangular marking pilot light, a clear lens and a color marking plate (white) are used for W (white) illumination.
- See B-346 for the marking plate size of rectangular pilot lights.
- See B-309 for other operating voltage such as 6V AC/DC, 12V AC/DC, and 110V DC.
- Terminal cover is installed on pilot lights for electric shock prevention.

Type	Terminal Cover	Quantity
6V, 12V, 24V AC/DC	APN-PVL	1
100V/110V AC, 200/220V AC	N-VL3	1
110V DC	N-VL3	1

Note: DC-DC converter types are not approved by UL and CSA, and not CE compliant.  
 • See B-314 for bottom view.

Reflector

1. The lamp housing of the square LED illuminated pilot lights has a built-in reflector.
2. Make sure that the reflector does not fall off when removing the lens or making plate.
3. When replacing the LED lamp of UPQN4 (rectangular), use a lamp holder tool (OR-55).
4. To remove the reflector, insert a flat screwdriver inside the groove of the reflector and lightly push out.

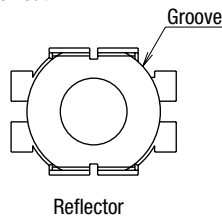

Panel Mounting of Square Pilot Lights

1. Tighten the square bezel to the operator and position the bezel correctly.
2. Lightly tighten the screw to secure the pilot light on the panel.
3. After tightening, do not turn the square bezel, otherwise it may fall off.

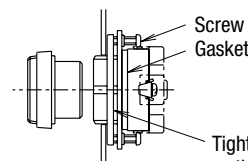

Tighten the screw lightly so that the panel does not bend.  
 Recommended tightening torque: 0.15 Nm

APEM

Switches & Pilot Lights

Control Boxes

Emergency Stop Switches

Enabling Switches

Safety Products

Explosion Proof

Terminal Blocks

Relays & Sockets

Circuit Protectors

Power Supplies

LED Illumination

Controllers

Operator Interfaces

Sensors

AUTO-ID

Flush Silhouette

ø16

ø22

ø30

Miniature

Pilot Lights

TWN

TWND

ARN

CS

## Dimensions (Pilot Light)

All dimensions in mm

## Round

## APN1

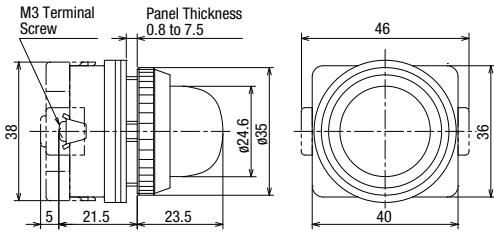
6V, 12V, 24V AC/DC (Terminal Cover: APN-PVL)  
Without LED Lamp

Terminal screws: M3

100 to 480V AC, 110V DC (Terminal Cover: N-VL3)

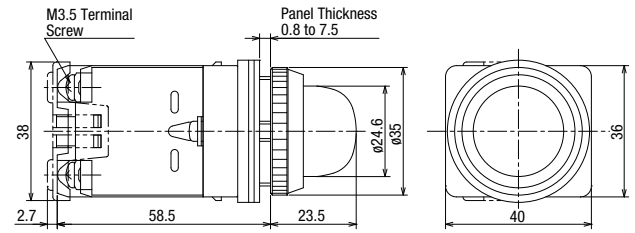

Terminal screws: M3.5

## Square Extended

## UPQN3B

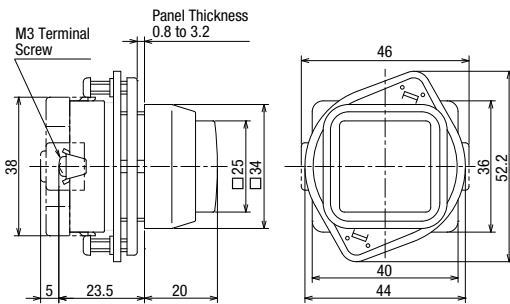
6V, 12V, 24V AC/DC (Terminal Cover: APN-PVL)  
Without LED Lamp

Terminal screws: M3

100 to 480V AC, 110V DC (Terminal Cover: N-VL3)

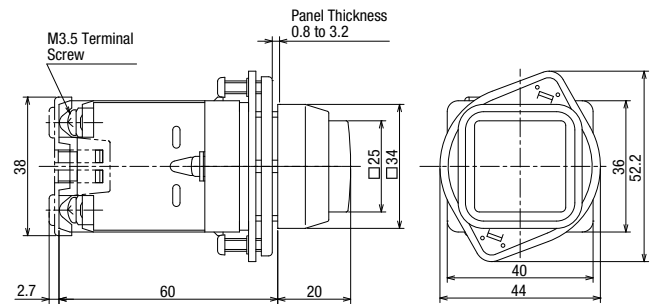

Terminal screws: M3.5

## Rectangular (Marking)

## UPQN4

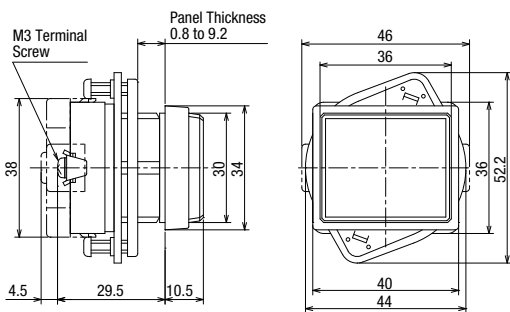
6V, 12V, 24V AC/DC (Terminal Cover: APN-PVL)  
Without LED Lamp

Terminal screws: M3

100 to 480V AC, 110V DC (Terminal Cover: N-VL3)

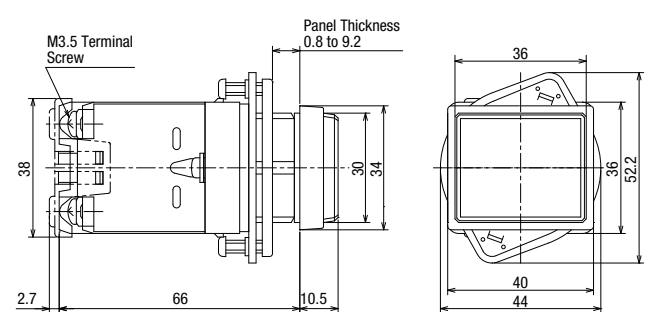





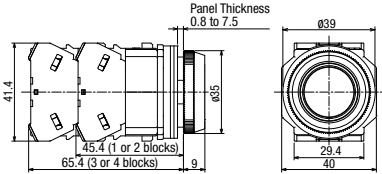

Terminal screws: M3.5

• See B-349 for wiring.

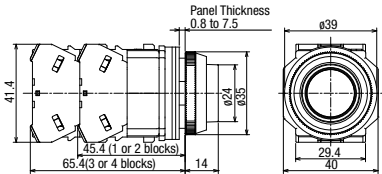
Flush/Extended/Extended with Half Shroud/Extended with Full Shroud

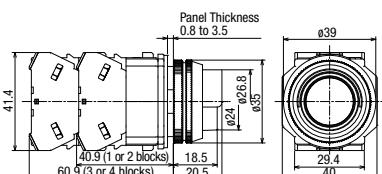
Package Quantity: 1

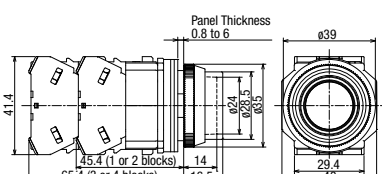
Shape	Operation	Contact	Part No. (Ordering No.)	Button Color Code	Dimensions (All dimensions in mm.)	
Flush ABD1 AOD1 	Momentary	1NO	ABD110N*	B		
		1NC	ABD101N*	G		
		1NO-1NC	ABD111N*	R		
		2NO	ABD120N*	Y		
		2NC	ABD102N*	S		
	Maintained	2NO-2NC	ABD122N*	W		Note
		1NO	AOD110N*	B		
		1NC	AOD101N*	G		
		1NO-1NC	AOD111N*	R		
		2NO	AOD120N*	Y		
2NC	AOD102N*	S				
2NO-2NC	AOD122N*	W	Note			
Extended ABD2 AOD2 	Momentary	1NO	ABD210N*	B		
		1NC	ABD201N*	G		
		1NO-1NC	ABD211N*	R		
		2NO	ABD220N*	Y		
		2NC	ABD202N*	S		
	Maintained	2NO-2NC	ABD222N*	W		
		1NO	AOD210N*	B		
		1NC	AOD201N*	G		
		1NO-1NC	AOD211N*	R		
		2NO	AOD220N*	Y		
2NC	AOD202N*	S				
2NO-2NC	AOD222N*	W				
Extended with Half Shroud ABGD2 AOGD2 	Momentary	1NO	ABGD210N*	B		
		1NC	ABGD201N*	G		
		1NO-1NC	ABGD211N*	R		
		2NO	ABGD220N*	Y		
		2NC	ABGD202N*	S		
	Maintained	2NO-2NC	ABGD222N*	W		
		1NO	AOGD210N*	B		
		1NC	AOGD201N*	G		
		1NO-1NC	AOGD211N*	R		
		2NO	AOGD220N*	Y		
2NC	AOGD202N*	S				
2NO-2NC	AOGD222N*	W				
Extended with Full Shroud ABFD2 AOFD2 	Momentary	1NO	ABFD210N*	B		
		1NC	ABFD201N*	G		
		1NO-1NC	ABFD211N*	R		
		2NO	ABFD220N*	Y		
		2NC	ABFD202N*	S		
	Maintained	2NO-2NC	ABFD222N*	W		
		1NO	AOFD210N*	B		
		1NC	AOFD201N*	G		
		1NO-1NC	AOFD211N*	R		
		2NO	AOFD220N*	Y		
2NC	AOFD202N*	S				
2NO-2NC	AOFD222N*	W				

- Specify a color code in place of \* in Part No. B (black), G (green), R (red), Y (yellow), S (blue), W (white)
- Round bezel (metal): Chrome-plated
- Pushbuttons with 1 or 3 contact blocks have a dummy block.
- See B-307 for other contact configurations and gold-plated silver contacts.
- See B-312 for bottom view.
- Terminal screws: M3.5
- Integrated terminal cover

**Note** ABD1, AOD1 with button color of B (black), G (green), or (R) red  
 Supply of color buttons B, G, R has been discontinued for ABD1/AOD1 without color code.  
 When ordering, make sure to specify the required button color code.

APEM

Switches & Pilot Lights

Control Boxes

Emergency Stop Switches

Enabling Switches

Safety Products

Explosion Proof

Terminal Blocks

Relays & Sockets

Circuit Protectors

Power Supplies

LED Illumination

Controllers

Operator Interfaces

Sensors

AUTO-ID

Flush Silhouette

ø16

ø22

ø30

Miniature

Pilot Lights

TWN

TWND











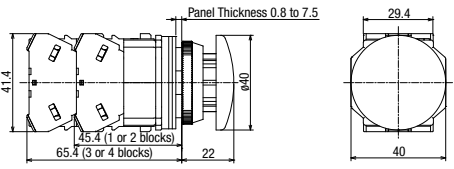

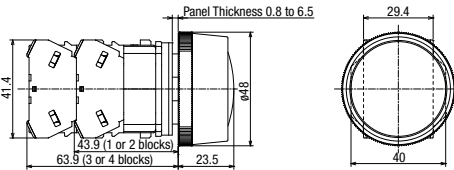
ARN

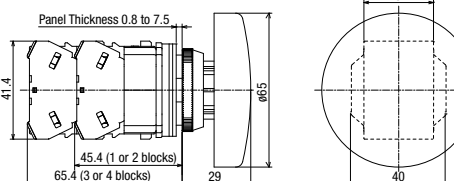
CS

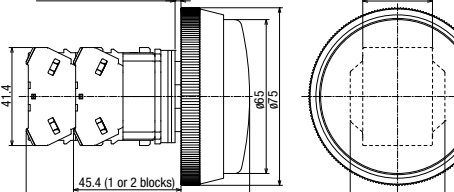

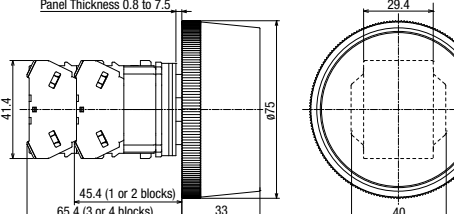
## Mushroom/Mushroom with Full Shroud/Jumbo Mushroom/Jumbo Mushrooms with Shallow/Deep Shroud/Pin Lock

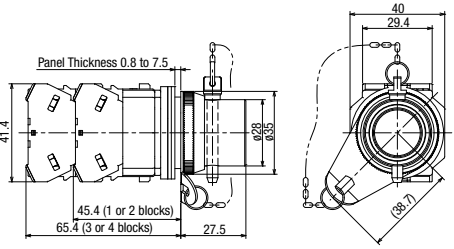
Package Quantity: 1

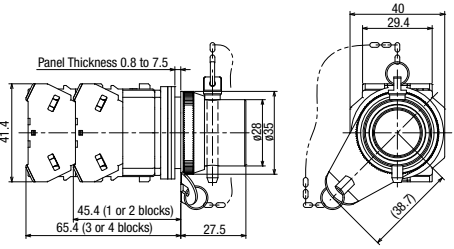





Shape	Operation	Contact	Part No. (Ordering No.)	Button Color Code	Dimensions (All dimensions in mm.)
Mushroom ABD3 AOD3 	Momentary	1NO	ABD310N*	B	
		1NC	ABD301N*	G	
		1NO-1NC	ABD311N*	R	
		2NO	ABD320N*	Y	
		2NO-2NC	ABD322N*	S	
	Maintained	1NO	AOD310N*	B	
		1NC	AOD301N*	G	
		1NO-1NC	AOD311N*	R	
		2NO	AOD320N*	Y	
		2NO-2NC	AOD322N*	S	
Mushroom with Full Shroud ABGD3 AOGD3 	Momentary	1NO	ABGD310N*	B	
		1NC	ABGD301N*	G	
		1NO-1NC	ABGD311N*	R	
		2NO	ABGD320N*	Y	
		2NO-2NC	ABGD322N*	S	
	Maintained	1NO	AOGD310N*	B	
		1NC	AOGD301N*	G	
		1NO-1NC	AOGD311N*	R	
		2NO	AOGD320N*	Y	
		2NO-2NC	AOGD322N*	S	
Jumbo Mushroom ABD4 	Momentary	1NO	ABD410N*	B G R Y	
		1NC	ABD401N*		
		1NO-1NC	ABD411N*		
		2NO	ABD420N*		
		2NC	ABD402N*		
		2NO-2NC	ABD422N*		
Jumbo Mushroom with Shallow Shroud ABGD4 	Momentary	1NO	ABGD410N*	B G R Y	
		1NC	ABGD401N*		
		1NO-1NC	ABGD411N*		
		2NO	ABGD420N*		
		2NC	ABGD402N*		
		2NO-2NC	ABGD422N*		
Jumbo Mushroom with Deep Shroud ABFD4 	Momentary	1NO	ABFD410N*	B G R Y	
		1NC	ABFD401N*		
		1NO-1NC	ABFD411N*		
		2NO	ABFD420N*		
		2NC	ABFD402N*		
		2NO-2NC	ABFD422N*		
Pin Lock (On-off Lock Type) (*1) ABD8P 	Momentary	1NO	ABD8P10N*	B G R Y	
		1NC	ABD8P01N*		
		1NO-1NC	ABD8P11N*		
		2NO	ABD8P20N*		
		2NC	ABD8P02N*		
		2NO-2NC	ABD8P22N*		
Pin Lock (On-lock Type) (*1) ABD8PN 	Momentary	1NO	ABD8PN10N*	B G R Y	
		1NC	ABD8PN01N*		
		1NO-1NC	ABD8PN11N*		
		2NO	ABD8PN20N*		
		2NC	ABD8PN02N*		
		2NO-2NC	ABD8PN22N*		

- Specify a color code in place of \* in Part No. B (black), G (green), R (red), Y (yellow), S (blue), W (white)
- Round bezel (metal): Chrome-plated
- Pin Lock (On-lock type): Button can be locked in depressed position by inserting the pin (the button cannot be locked in reset position).
- Pushbuttons with 1 or 3 contact blocks have a dummy block.

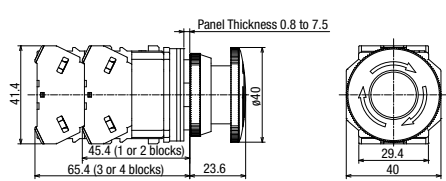
- See **B-307** for other contact configurations and gold-plated silver contacts.
- See **B-342** for maintenance parts.
- \*1) The pin for ABD8P is ø4.6 mm and is not compatible with ABN8P (old series).
- See **B-312** for bottom view.
- Terminal screws: M3.5
- Integrated terminal cover

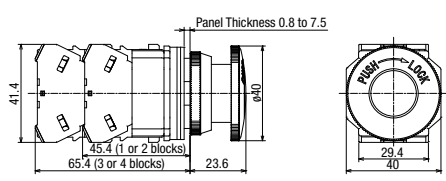
Pushlock Turn Reset/ Push Turn Lock/ Pull/ Push-Pull

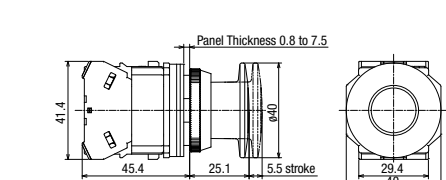
Package Quantity: 1

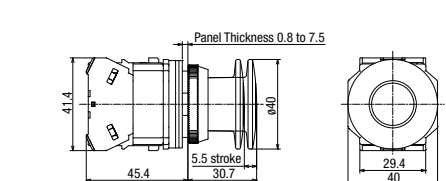
Shape	Contact	Part No. (Ordering No.)	Button Color Code	Dimensions (All dimensions in mm.)
Mushroom Pushlock Turn Reset (*1) AVD3 	1NO	AVD310N*	R Y	
	1NC	AVD301N*		
	1NO-1NC	AVD311N*		
	2NO	AVD320N*		
	2NO-2NC	AVD322N*		
Mushroom Push Turn Lock AJD3 	1NO	AJD310N*	B G R Y	
	1NC	AJD301N*		
	1NO-1NC	AJD311N*		
	2NO	AJD320N*		
	2NO-2NC	AJD322N*		
Mushroom Pull AZD3 	1NO	AZD310N*	B G R Y	
	1NO-1NC	AZD311N*		
	2NO	AZD320N*		
	2NC	AZD302N*		
Mushroom Push-Pull (*2) AYD31 	1NO-1NC	AYD3111N*	B G R Y	
	2NO	AYD3120N*		
	2NC	AYD3102N*		

- Specify a color code in place of \* in Part No. B (black), G (green), R (red), Y (yellow)
- Round bezel (metal): Chrome-plated
- Pushbuttons with 1 or 3 contact blocks have a dummy block.
- See **B-307** for other contact configurations and gold-plated silver contacts.
- Mushroom pull has up to 2 contact blocks.

\*1) Pushlock turn reset switches cannot be used as emergency stop switches. When emergency stop switches are required, use XN series emergency stop switches (ISO 13850 and IEC 60947-5-5 compliant).

\*2) Push-Pull switches with red button cannot be used as emergency stop switches. When emergency stop switches are required, use XN series emergency stop switches (ISO 13850 and IEC 60947-5-5 compliant).

- See **B-312** for bottom view.
- Terminal screws: M3.5
- Integrated terminal cover

**Pushbutton operation**

Pushlock Turn Reset

Button is maintained when pressed and is reset when turned clockwise.

Push Turn Lock

Button is locked when turned clockwise in the depressed position and is reset when turned counterclockwise.

Pull

Pulling the button operates the contacts, and releasing the button return the contacts.

Push-Pull

2-position switches with button maintained in both depressed and reset positions.

Push contact operation

Push-Pull contact operation

Contact	AZD3	
	Normal	Pull
1NO		
2NO-2NC		
2NO		
2NC		

Contact	AYD31	
	Push	Pull
1NO		
2NO		
2NC		

APEM

Switches & Pilot Lights

Control Boxes

Emergency Stop Switches

Enabling Switches

Safety Products

Explosion Proof

Terminal Blocks

Relays & Sockets

Circuit Protectors

Power Supplies

LED Illumination

Controllers

Operator Interfaces

Sensors

AUTO-ID

Flush Silhouette

ø16

ø22

ø30

Miniature

Pilot Lights

TWN

TWND

ARN

CS





## LED Illuminated Extended/Extended with Full Shroud

Package Quantity: 1

Shape	Base	Operation	Operating Voltage	Contact	Part No. (Ordering No.)	Button Color Code	
Extended ALD2 AOLD2   (24V AC/DC)   With transformer (100/110V AC)	BA9S	Momentary	24V AC/DC	1NO-1NC	ALD22211DN*	R G Y A S PW	
				2NO	ALD2220DN*		
				2NC	ALD2220DN*		
			100/110V AC	1NO-1NC	ALD21611DN*		
				2NO	ALD21620DN*		
				2NC	ALD21602DN*		
		200/220V AC	1NO-1NC	ALD22611DN*			
			2NO	ALD22620DN*			
			2NC	ALD22602DN*			
		Maintained	24V AC/DC	1NO-1NC	AOLD22211DN*		R G Y A S PW
				2NO	AOLD2220DN*		
				2NC	AOLD2220DN*		
100/110V AC	1NO-1NC		AOLD21611DN*				
	2NO		AOLD21620DN*				
	2NC		AOLD21602DN*				
200/220V AC	1NO-1NC	AOLD22611DN*					
	2NO	AOLD22620DN*					
	2NC	AOLD22602DN*					
Extended with Full Shroud ALFD2 AOLFD2   (24V AC/DC)   With transformer (100/110V AC)	BA9S	Momentary	24V AC/DC	1NO-1NC	ALFD22211DN*	R G Y A S PW	
				2NO	ALFD2220DN*		
				2NC	ALFD2220DN*		
			100/110V AC	1NO-1NC	ALFD21611DN*		
				2NO	ALFD21620DN*		
				2NC	ALFD21602DN*		
		200/220V AC	1NO-1NC	ALFD22611DN*			
			2NO	ALFD22620DN*			
			2NC	ALFD22602DN*			
		Maintained	24V AC/DC	1NO-1NC	AOLFD22211DN*		R G Y A S PW
				2NO	AOLFD2220DN*		
				2NC	AOLFD2220DN*		
100/110V AC	1NO-1NC		AOLFD21611DN*				
	2NO		AOLFD21620DN*				
	2NC		AOLFD21602DN*				
200/220V AC	1NO-1NC	AOLFD22611DN*					
	2NO	AOLFD22620DN*					
	2NC	AOLFD22602DN*					

- Specify a color code in place of \* in Part No. R (red), G (green), Y (yellow), A (amber), S (blue), PW (pure white)
- Illuminated pushbuttons have an LED lamp installed.
- Round bezel (metal): Chrome-plated
- See **B-308** for other operating voltage such as 6V AC/DC, 12V AC/DC, and 110V DC.

- See **B-308** for other contact configurations and gold-plated silver contacts.
- Illuminated pushbuttons of 24V AC/DC or below with 2 or 4 contact blocks have a dummy block.
- See **B-314** for bottom view.

## Dimensions

All dimensions in mm

## Extended, LED illuminated (momentary/maintained)

ALD2/AOLD2 (terminal screws M3.5)

Integrated terminal cover

6, 12, 24V AC/DC - Without LED Lamp

100/110V AC, 200/220V AC (240V AC or below)

110V DC, 380V AC or over

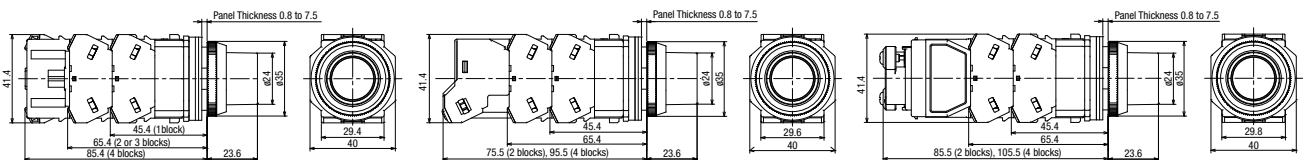

## Extended with Full Shroud, LED illuminated (momentary/maintained)

ALFD2/AOLFD2 (terminal screws M3.5)

Integrated terminal cover

6, 12, 24V AC/DC - Without LED Lamp

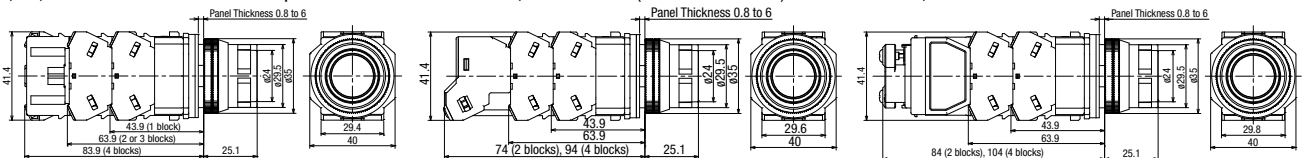

100/110V AC, 200/220V AC (240V AC or below)

110V DC, 380V AC or over



LED Illuminated Mushroom (ø40)/Mushroom Pushlock Turn Reset

Package Quantity: 1

Shape	Base	Operation	Operating Voltage	Contact	Part No. (Ordering No.)	Color Code		
Mushroom (ø40) ALD3 AOLD3  (24V AC/DC)  With transformer (100/110V AC)	BA9S	Momentary	24V AC/DC	1NO-1NC	ALD32211DN*	R G Y A S		
				2NO	ALD32220DN*			
				2NC	ALD32202DN*			
			100/110V AC	1NO-1NC	ALD31611DN*			
				2NO	ALD31620DN*			
				2NC	ALD31602DN*			
		200/220V AC	1NO-1NC	ALD32611DN*				
			2NO	ALD32620DN*				
			2NC	ALD32602DN*				
		Maintained	24V AC/DC	—	1NO-1NC		AOLD32211DN*	R G Y A W S
					2NO		AOLD32220DN*	
					2NC		AOLD32202DN*	
100/110V AC	1NO-1NC		AOLD31611DN*					
	2NO		AOLD31620DN*					
	2NC		AOLD31602DN*					
200/220V AC	1NO-1NC	AOLD32611DN*						
	2NO	AOLD32620DN*						
	2NC	AOLD32602DN*						
Mushroom Pushlock Turn Reset (*1) AVLD3  (24V AC/DC)	BA9S	—	24V AC/DC	1NO-1NC	AVLD32211DN*	R		
				2NO	AVLD32220DN*			
				2NC	AVLD32202DN*			
			100/110V AC	1NO-1NC	AVLD31611DN*			
				2NO	AVLD31620DN*			
				2NC	AVLD31602DN*			
			200/220V AC	1NO-1NC	AVLD32611DN*			
				2NO	AVLD32620DN*			
				2NC	AVLD32602DN*			

- Specify a color code in place of \* in Part No. R (red), G (green), Y (yellow), A (amber), S (blue)
- Illuminated pushbuttons have an LED lamp installed.
- Round bezel (metal): Chrome-plated
- See **B-308** for other operating voltage such as 6V AC/DC, 12V AC/DC, and 110V DC.
- See **B-308** for other contact configurations and gold-plated silver contacts.
- Illuminated pushbuttons of 24V AC/DC or below with 2 or 4 contact blocks have a dummy block.

\*1) Pushlock turn reset switches cannot be used as emergency stop switches. When emergency stop switches are required, use XN series emergency stop switches (ISO 13850 and IEC 60947-5-5 compliant).

• See **B-314** for bottom view.

Illuminated pushbutton operation

Pushlock Turn Reset

Button is maintained when pressed and is reset when turned clockwise.

- APEM
- Switches & Pilot Lights
- Control Boxes
- Emergency Stop Switches
- Enabling Switches
- Safety Products
- Explosion Proof
- Terminal Blocks
- Relays & Sockets
- Circuit Protectors
- Power Supplies
- LED Illumination
- Controllers
- Operator Interfaces
- Sensors
- AUTO-ID

- Flush Silhouette
- ø16
- ø22
- ø30
- Miniature
- Pilot Lights

- TWN
- TWND
- ARN
- CS

Dimensions

All dimensions in mm

Mushroom, LED illuminated (momentary/maintained)

ALD3/AOLD3 (terminal screws M3.5)

6, 12, 24V AC/DC · Without LED Lamp

Integrated terminal cover

100/110V AC, 200/220V AC

110V DC, 380V AC or over

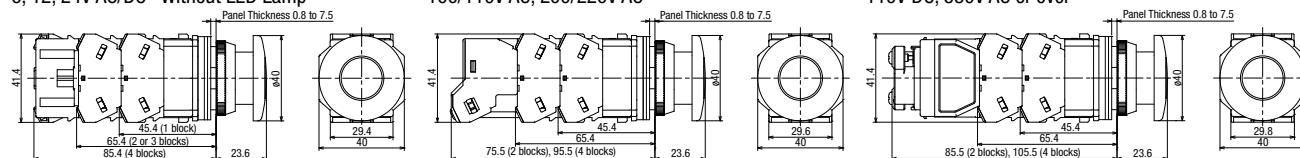

Mushroom Pushlock Turn Reset, LED illuminated

AVLD (terminal screws M3.5)

6, 12, 24V AC/DC · Without LED Lamp

Integrated terminal cover

100/110V AC, 200/220V AC

110V DC, 380V AC or over

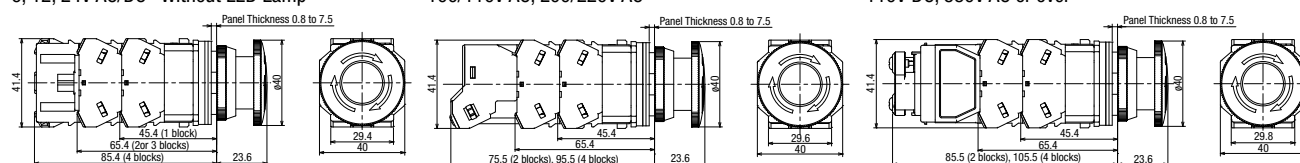

Download catalogs and CAD from <http://eu.idec.com/downloads>

## ASD Selector Switches (Knob Operator)

Package Quantity: 1

Shape	Knob Operator ASD											
	Contact Configuration					Maintained	Spring Return from Right	Spring Return from Left				
	Contact	Contact Block		Operator Position		1 2	1 2	Contact Block		Operator Position		1 2
Mounting Position		Contact	1	2	Mounting Position			Contact	1	2		
90° 2-position	1NO (10)	①	NO		●	ASD210N	ASD2110N	①	NO	●		ASD2210N
		②	—	Dummy Block				②	—	—		
	1NO-1NC (11)	①	NO		●	ASD211N	ASD2111N	①	NO	●		ASD2211N
		②	NC	●				②	NC		●	
	2NO (20)	①	NO		●	ASD220N	ASD2120N	①	NO	●		ASD2220N
		②	NO		●			②	NO	●		
	2NO-2NC (22)	①	NO		●	ASD222N	ASD2122N	①	NO	●		ASD2222N
		②	NC	●				②	NC		●	
		③	NO		●			③	NO	●		
		④	NC	●				④	NC		●	
45° 3-position	2NO (20)	①	NO	●		ASD320N	ASD3120N	ASD3220N		ASD3320N		
		②	NO		●			ASD3220N				
	2NC (02)	①	NC		●	ASD302N	ASD3102N	ASD3202N		ASD3302N		
		②	NC	●				ASD3202N				
	2NO-2NC (22)	①	NO	●		ASD322N	ASD3122N	ASD3222N		ASD3322N		
		②	NO		●			ASD3222N				
		③	NC		●			ASD3222N				
		④	NC	●				ASD3222N				
	4NO (40)	①	NO	●		ASD340N	ASD3140N	ASD3240N		ASD3340N		
		②	NO		●			ASD3240N				
		③	NO	●				ASD3240N				
		④	NO		●			ASD3240N				
	4NC (04)	①	NC		●	ASD304N	ASD3104N	ASD3204N		ASD3304N		
		②	NC	●				ASD3204N				
		③	NC		●			ASD3204N				
		④	NC	●				ASD3204N				
	☆ 3S	①	NO	●		ASD33SN-243	—	—		—		
		②	NO		●			—				
		③	NC		●			—				
		④	—	Dummy Block				—				

- Knob: Black
- Round bezel (metal): Chrome-plated
- Selector switches with 1 or 3 contact blocks have a dummy block.
- Knob operator can be installed at every 45 degrees intervals in addition to the positions shown in the above table.
- See B-321 to B-322 for other contact configurations.

- Turn the operator to each position accurately.
- Selector switches with ☆ have a half contact operating current (load switching current value). Rated insulation voltage and rated current remain the same.
- See B-308 for gold-plated silver contacts.
- See B-312 for bottom view.

## Contact Block Mounting Position

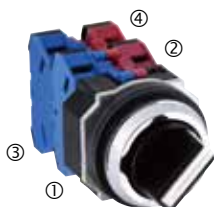

## Dimensions

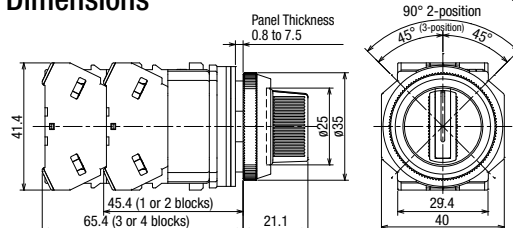

All dimensions in mm.

Terminal Screws: M3.5 Terminal cover: integrated

For more information, visit <http://eu.idec.com>

ASD□L Selector Switches (Lever Operator)

Package Quantity: 1

Shape	Lever Operator ASD□L											
	Contact Configuration					Maintained 1 2	Spring Return from Right 1 2	Spring Return from Left				
	Contact	Contact Block		Operator Position				Mounting Position	Contact	Operator Position		1 2
90° 2-position		1NO (10)	①	NO		●	ASD2L10N			ASD21L10N	①	
	②		—	Dummy Block		②		—	—			
	1NO-1NC (11)	①	NO		●	ASD2L11N	ASD21L11N	①	NO	●	ASD22L11N	
		②	NC	●				②	NC			●
	2NO (20)	①	NO		●	ASD2L20N	ASD21L20N	①	NO	●	ASD22L20N	
		②	NO		●			②	NO	●		
	2NO-2NC (22)	①	NO		●	ASD2L22N	ASD21L22N	①	NO	●	ASD22L22N	
		②	NC	●				②	NC			●
		③	NO		●			③	NO	●		
		④	NC	●				④	NC			●
	45° 3-position	2NO (20)	①	NO	●		ASD3L20N	ASD31L20N	ASD32L20N	ASD33L20N		
			②	NO		●						
2NC (02)		①	NC		●	ASD3L02N	ASD31L02N	ASD32L02N	ASD33L02N			
		②	NC	●								
2NO-2NC (22)		①	NO	●		ASD3L22N	ASD31L22N	ASD32L22N	ASD33L22N			
		②	NO		●							
		③	NC		●							
		④	NC	●								
4NO (40)		①	NO	●		ASD3L40N	ASD31L40N	ASD32L40N	ASD33L40N			
		②	NO		●							
		③	NO	●								
		④	NO		●							
4NC (04)		①	NC		●	ASD3L04N	ASD31L04N	ASD32L04N	ASD33L04N			
		②	NC	●								
		③	NC		●							
		④	NC	●								
☆ 3S		①	NO	●		ASD3L3SN-243☆	—	—	—			
		②	NO		●							
		③	NC		●							
		④	—	Dummy Block								

- Lever: Black
- Round bezel (metal): Chrome-plated
- Selector switches with 1 or 3 contact blocks have a dummy block.
- Knob operator can be installed at every 45 degrees intervals in addition to the positions shown in the above table.

- Turn the operator to each position accurately.
- Selector switches with ☆ have a half contact operating current (load switching current value). Rated insulation voltage and rated current remain the same.
- See B-308 for gold-plated silver contacts.
- See B-312 for bottom view.

Contact Block Mounting Position



Dimensions

All dimensions in mm.

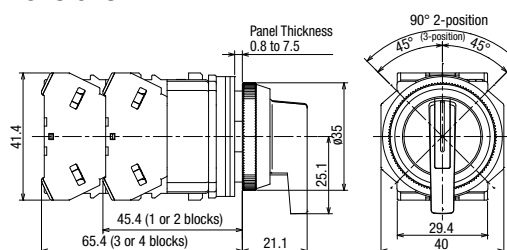

Terminal Screws: M3.5 Terminal cover: integrated

- APEM
- Switches & Pilot Lights
- Control Boxes
- Emergency Stop Switches
- Enabling Switches
- Safety Products
- Explosion Proof
- Terminal Blocks
- Relays & Sockets
- Circuit Protectors
- Power Supplies
- LED Illumination
- Controllers
- Operator Interfaces
- Sensors
- AUTO-ID
- Flush Silhouette
- ø16
- ø22
- ø30
- Miniature
- Pilot Lights
- TWN
- TWND
- ARN
- CS

## ASD□K Key Selector Switches

Package Quantity: 1

Shape	Key Selector (Key No. 0) ASD□K													
	Contact Configuration				Maintained	Spring Return from Right	Spring Return from Left							
Contact	Contact Block		Operator Position		1	2	Contact Block		Operator Position		1	2		
	Mounting Position	Contact	1	2			Mounting Position	Contact	1	2				
90° 2-position	1NO (10)	①	NO	●	ASD2K10N	ASD21K10N	①	NO	●	ASD22K10N	ASD22K10N	ASD22K10N		
		②	—	Dummy Block			②	—	—					
	1NO-1NC (11)	①	NO	●	ASD2K11N	ASD21K11N	①	NO	●	ASD22K11N	ASD22K11N	ASD22K11N		
		②	NC	●			②	NC	●					
	2NO (20)	①	NO	●	ASD2K20N	ASD21K20N	①	NO	●	ASD22K20N	ASD22K20N	ASD22K20N		
		②	NO	●			②	NO	●					
	2NO-2NC (22)	①	NO	●	ASD2K22N	ASD21K22N	①	NO	●	ASD22K22N	ASD22K22N	ASD22K22N		
		②	NC	●			②	NC	●					
③		NO	●	③			NO	●						
④		NC	●	④			NC	●						
45° 3-position	2NO (20)	①	NO	●	ASD3K20N	ASD31K20N	ASD32K20N	ASD32K20N	ASD33K20N	ASD33K20N	ASD33K20N			
		②	NO	●								②	NO	●
	2NC (02)	①	NC	●	ASD3K02N	ASD31K02N	ASD32K02N	ASD32K02N	ASD33K02N	ASD33K02N	ASD33K02N			
		②	NC	●								②	NC	●
	2NO-2NC (22)	①	NO	●	ASD3K22N	ASD31K22N	ASD32K22N	ASD32K22N	ASD33K22N	ASD33K22N	ASD33K22N			
		②	NO	●								②	NO	●
		③	NC	●								③	NC	●
		④	NC	●								④	NC	●
	4NO (40)	①	NO	●	ASD3K40N	ASD31K40N	ASD32K40N	ASD32K40N	ASD33K40N	ASD33K40N	ASD33K40N			
		②	NO	●								②	NO	●
		③	NO	●								③	NO	●
		④	NO	●								④	NO	●
	4NC (04)	①	NC	●	ASD3K04N	ASD31K04N	ASD32K04N	ASD32K04N	ASD33K04N	ASD33K04N	ASD33K04N			
		②	NC	●								②	NC	●
		③	NC	●								③	NC	●
		④	NC	●								④	NC	●
☆ 3S	①	NO	●	ASD3K3SN-243☆	—	—	—	—	—	—				
	②	NO	●								②	NO	●	
	③	NC	●								③	NC	●	
	④	—	Dummy Block								④	—	—	

CS

- Cylinder: Chrome-plated
- Round bezel (metal): Chrome-plated
- Key selector switches with 1 or 3 contact blocks have a dummy block.
- On spring-returned types, the key can be released only from the maintained position. On maintained types, the key can be released from every position. See B-308 for specifying key retained positions.

- Key selector switch is supplied with two standard keys.
  - (1) Insert the key completely before turning the key, otherwise failure will result.
  - (2) Turn the operator to each position accurately.
- Different key number is available upon request. Contact IDEC.
- Selector switches with ☆ have a half contact operating current (load switching current value). Rated insulation voltage and rated current remain the same.
- See B-308 for gold-plated silver contacts.
- See B-312 for bottom view.

## Contact Block Mounting Position



## Dimensions

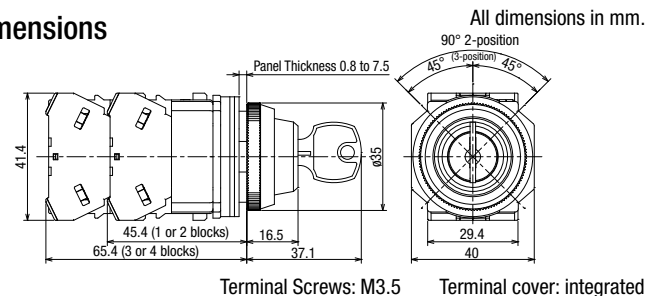



ASLD Illuminated Selector Switches (LED)

Package Quantity: 1

Shape	Illuminated Selector Switches (BA9S Base) ASLD												Color Code
	Contact	Contact Configuration		Operating Voltage	Maintained	Spring Return from Right	Spring Return from Left		Color Code				
		Mounting Position	Contact		1	2	1	2		1	2		
90° 2-position	1NO-1NC (11)	①	NO	●	24V AC/DC	ASLD22211DN*	ASLD212211DN*	①	NO	●	ASLD222211DN*	R G Y A S PW	
		②	NC	●	100/110V AC	ASLD21611DN*	ASLD211611DN*	②	NC	●	ASLD221611DN*		
					200/220V AC	ASLD22611DN*	ASLD212611DN*				ASLD222611DN*		
		①	NO	●	24V AC/DC	ASLD22220DN*	ASLD212220DN*	①	NO	●	ASLD22220DN*		
		②	NO	●	100/110V AC	ASLD21620DN*	ASLD211620DN*	②	NO	●	ASLD221620DN*		
					200/220V AC	ASLD22620DN*	ASLD212620DN*				ASLD222620DN*		
	2NO-2NC (22)	①	NO	●	24V AC/DC	ASLD22222DN*	ASLD212222DN*	①	NO	●	ASLD22222DN*		
		②	NC	●	100/110V AC	ASLD21622DN*	ASLD211622DN*	②	NC	●	ASLD221622DN*		
		③	NO	●	200/220V AC	ASLD22622DN*	ASLD212622DN*	③	NO	●	ASLD222622DN*		
		④	NC	●	—	—	—	④	NC	●	—		
					—	—	—				—		
					—	—	—				—		
45° 3-position	2NO (20)	①	NO	●	24V AC/DC	ASLD32220DN*	ASLD312220DN*	ASLD32220DN*	ASLD33220DN*	R G Y A S PW			
		②	NO	●	100/110V AC	ASLD31620DN*	ASLD311620DN*	ASLD321620DN*	ASLD331620DN*				
					200/220V AC	ASLD32620DN*	ASLD312620DN*	ASLD322620DN*	ASLD332620DN*				
		①	NC	●	24V AC/DC	ASLD32202DN*	ASLD312202DN*	ASLD32202DN*	ASLD332202DN*				
		②	NC	●	100/110V AC	ASLD31602DN*	ASLD311602DN*	ASLD321602DN*	ASLD331602DN*				
					200/220V AC	ASLD32602DN*	ASLD312602DN*	ASLD322602DN*	ASLD332602DN*				
	2NO-2NC (22)	①	NO	●	24V AC/DC	ASLD32222DN*	ASLD312222DN*	ASLD32222DN*	ASLD33222DN*				
		②	NO	●	100/110V AC	ASLD31622DN*	ASLD311622DN*	ASLD321622DN*	ASLD331622DN*				
		③	NC	●	200/220V AC	ASLD32622DN*	ASLD312622DN*	ASLD322622DN*	ASLD332622DN*				
		④	NC	●	—	—	—	—	—				
	4NO (40)	①	NO	●	24V AC/DC	ASLD32240DN*	ASLD312240DN*	ASLD32240DN*	ASLD332240DN*				
		②	NO	●	100/110V AC	ASLD31640DN*	ASLD311640DN*	ASLD321640DN*	ASLD331640DN*				
		③	NO	●	200/220V AC	ASLD32640DN*	ASLD312640DN*	ASLD322640DN*	ASLD332640DN*				
		④	NO	●	—	—	—	—	—				
	4NC (04)	①	NC	●	24V AC/DC	ASLD32204DN*	ASLD312204DN*	ASLD32204DN*	ASLD332204DN*				
		②	NC	●	100/110V AC	ASLD31604DN*	ASLD311604DN*	ASLD321604DN*	ASLD331604DN*				
		③	NC	●	200/220V AC	ASLD32604DN*	ASLD312604DN*	ASLD322604DN*	ASLD332604DN*				
		④	NC	●	—	—	—	—	—				

- Specify a color code in place of \* in Part No.  
R (red), G (green), Y (yellow), A (amber), S (blue), PW (pure white)
- Round bezel (metal): Chrome-plated
- Illuminated selector switches have an LED lamp installed.
- Use a pure white (PW) LED for yellow (Y) illumination.
- See B-309 for other operating voltage such as 6V AC/DC, 12V AC/DC, and 110V DC.

- Illuminated selector switches of 24V AC/DC or below with 2 or 4 contact blocks have a dummy block.
- Turn the operator to each position accurately.
- See B-309 for gold-plated silver contacts.
- See B-314 for bottom view.

Contact Block Mounting Position Dimensions

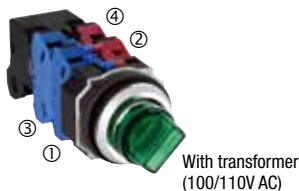
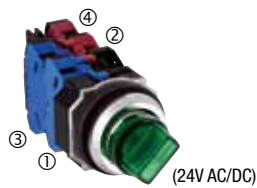

6, 12, 24V AC/DC  
Without LED Lamp

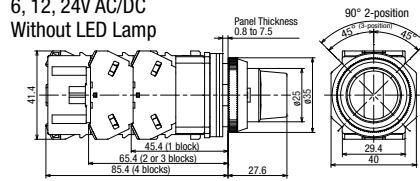

100/110V AC, 200/220V AC  
(240V AC or below)

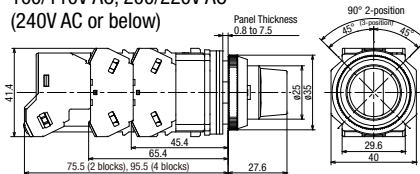

110V DC  
380V AC or over

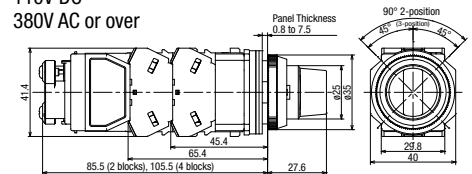

All dimensions in mm.

Terminal Screws: M3.5 Terminal cover: integrated

APEM

Switches & Pilot Lights

Control Boxes

Emergency Stop Switches

Enabling Switches

Safety Products

Explosion Proof

Terminal Blocks

Relays & Sockets

Circuit Protectors

Power Supplies

LED Illumination

Controllers

Operator Interfaces

Sensors

AUTO-ID

Flush Silhouette

ø16

ø22

ø30

Miniature

Pilot Lights

TWN

TWND

ARN

CS

## ASBD2 Selector Pushbuttons

Package Quantity: 1

Shape	Contact Configuration	Circuit Code	Contact Block		Ring Position				Button Color Code	Ring Operator			
			Mounting Position	Contact	Left		Right			Part No. (Ordering No.)			
					Normal	Push	Normal	Push					
	11 (1NO-1NC)	A03	①	NO		●		●	B G R Y	ASBD211N-A03*			
			②	NC	●								
		22 (2NO-2NC)	A08	①	NO		●				●	B G R Y	ASBD222N-A08*
				②	NC	●							
	③			NO		●		●					
	④			NC	●								
	☆ C10	D10	①	NO		●		●	☆ ASBD222N-C10*				
			②	NO				●					
			③	NC	●			●					
			④	NC	●								
	☆ E10	F10	①	NO		●			☆ ASBD222N-E10*				
			②	NO				●					
			③	NC			●	●					
			④	NC	●								
	☆ F10		①	NO				●	☆ ASBD222N-F10*				
			②	NO		●							
			③	NC			●						
			④	NC	●								

• Specify a color code in place of \* in Part No. B (black), G (green), R (red), Y (yellow)

• Bezel (metal): Chrome-plated

• Circuit codes E and F: The right and left NC contact blocks on circuit code E or F may overlap each other while turning the ring operator. The NO and NC contact blocks on circuit code F may overlap each other while pressing the button.

• When using the selector pushbutton, do not turn the ring operator with the pushbutton depressed. Otherwise, damage or failure may be caused.

• Selector switches with ☆ have a half contact operating current (load switching current value). Rated insulation voltage and rated current remain the same.

• See **B-312** for bottom view.

## Contact Block Mounting Position

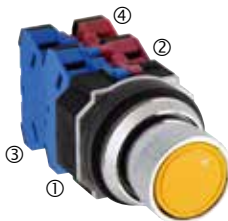

## Dimensions

## Ring operator (90° 2-position)

All dimensions in mm.

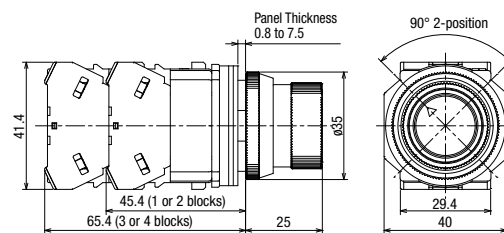

Terminal Screws: M3.5

Terminal cover: integrated

## Pilot Lights (Round)

Package Quantity: 1

Shape	Illumination	Base	Operating Voltage	Part No. (Ordering No.)	Color Code	LED Lamp Part No.
Round APD1  (24V AC/DC)	LED	BA9S	24V AC/DC	APD122DN*	R, G, Y, A, S, PW	LSRD-2
			100/110V AC	APD116DN*	R, G, Y, A, S, PW	LSRD-6
			200/220V AC	APD126DN*	R, G, Y, A, S, PW	

- Specify a color code in place of \* in Part No.  
R (red), G (green), Y (yellow), A (amber), S (blue), PW (pure white)
- Round bezel (metal): Chrome-plated
- Pilot lights have an LED lamp installed.
- See **B-309** for other operating voltage such as 6V AC/DC, 12V AC/DC, and 110V DC.
- See **B-309** for how to specify units without LED lamps.
- Terminal cover is installed on pilot lights for electric shock prevention.

Type	Terminal Cover	Quantity
6V, 12V, 24V AC/DC	APN-PVL	1
100V/110V AC, 200/220V AC	N-VL3	1
110V DC	N-VL3	1

- Note: DC-DC converter types are not approved by UL and CSA, and not CE compliant.
- See **B-314** for bottom view.

## Dimensions

### Round, LED illuminated

6V, 12V, 24V AC/DC - Without LED Lamp (Terminal Cover: APD-PVL)

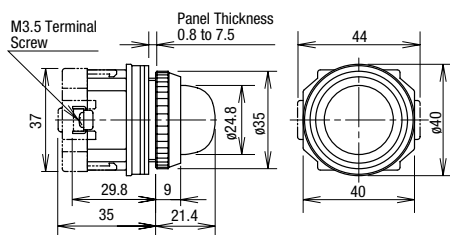

Terminal Screws: M3.5

100 to 480V AC, 110V DC (Terminal Cover: N-VL3)

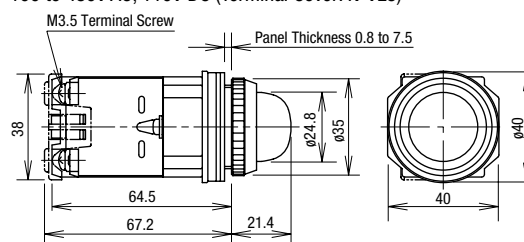

Terminal Screws: M3.5



All dimensions in mm.

- See **B-349** for wiring.

- APEM
- Switches & Pilot Lights
- Control Boxes
- Emergency Stop Switches
- Enabling Switches
- Safety Products
- Explosion Proof
- Terminal Blocks
- Relays & Sockets
- Circuit Protectors
- Power Supplies
- LED Illumination
- Controllers
- Operator Interfaces
- Sensors
- AUTO-ID
- Flush Silhouette
- ø16
- ø22
- ø30
- Miniature
- Pilot Lights
- TWN
- TWND
- ARN
- CS

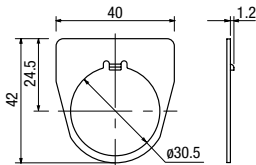

## Nameplates

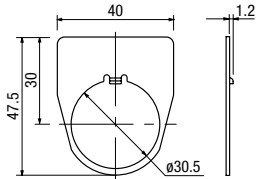
Model	Legend	Material	Part No.	Ordering No.	Package Quantity	Dimensions (mm)
 For TWN/TWND	Blank	Aluminium 1.2 mm thick White letters on black background	NA-0	NA-0	1	
				NA-0PN10	10	
	With Legend		NA-□	NA-□	1	
				NA-□PN10	10	
 For TWN/TWND	Blank	Aluminium 1.2 mm thick Black	NALO	NALO	1	
				NALOPN10	10	

Specify a legend code in place of □ in the Ordering No.

## Legends

□: Code	Legend
1	ON
2	OFF
3	START
4	STOP
31	OFF ON
35	HAND AUTO
53	HAND OFF AUTO

## Shape and Engraving Area

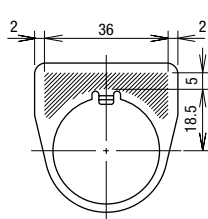

NA

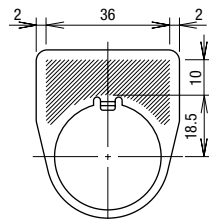











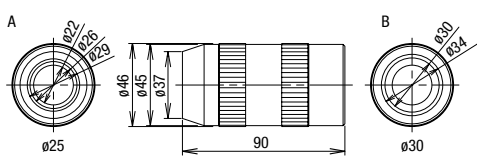
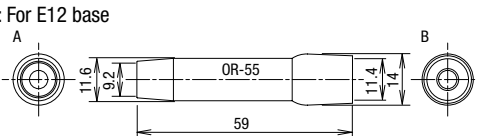

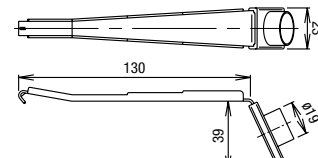
NALO

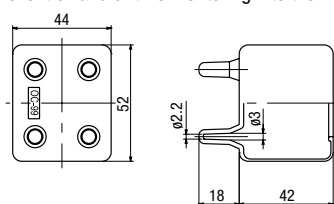
All dimensions in mm.

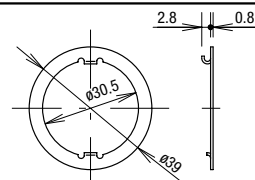
## Example (when the legend height is 4 mm)

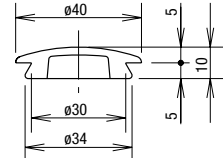
Shape	Engraving Area (mm)		Max. No. of Lines	No. of Letters on 1 Line
	Height	Width		
NA	5	36	1	14
NALO	10	36	2	14

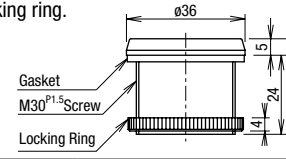
Accessories

Shape	Material	Part No.	Ordering No.	Package Quantity	Remarks
 <p>For TWN/TWND</p>	Nitril rubber (black)	OR-12	OR-12	1	<ul style="list-style-type: none"> <li>Used to tighten the round bezel when installing the ø30 or ø25 switch onto a panel from the front.</li> <li>A: TWS series (ø25)    B: TWN/TWND series (ø30)</li> </ul> 
 <p>For TWN/TWND</p>	Nitril rubber (black)	OR-55	OR-55	1	<ul style="list-style-type: none"> <li>Used to install and remove the LED/incandescent lamps.</li> <li>See B-345.</li> <li>A: For BA9S base</li> <li>B: For E12 base</li> </ul> 
 <p>For TWN</p>	Metal (zinc-plated) Rubber (nitril)	TW-KC1	TW-KC1	1	<ul style="list-style-type: none"> <li>Used to remove transformer units.</li> <li>See B-347 for how to use.</li> </ul> 
 <p>For momentary 1 layer of contact blocks (2 contact blocks)</p> <p>For TWN</p>	Nitril rubber (black)	OC-99	OC-99	1	<ul style="list-style-type: none"> <li>Rubber boot used to prevent oil and dirt from entering into the contact block.</li> <li>Temperature range: -5 to +60°C</li> </ul>  <ul style="list-style-type: none"> <li>When inserting a cable, cut the projection on the cover to match the cable size.</li> </ul>
 <p>For TWN/TWND</p>	Metal (diecast) (zinc-plated)	OGL-11	OGL-11PN10	10	<ul style="list-style-type: none"> <li>Used to prevent the operator from turning. Generally used when using no nameplates on selector switches and selector pushbuttons.</li> <li>See B-345 for installation.</li> <li>Cannot be used for pin lock.</li> </ul> 
 <p>For TWN/TWND</p>	Nitril rubber (black) Nitril rubber (gray)	OB-13B OB-13	OB-13BP05 OB-13PN05	5	<ul style="list-style-type: none"> <li>Used to plug unused ø30.5 mm mounting holes.</li> <li>Degree of protection: IP40</li> </ul> 
 <p>For TWN/TWND</p>	Plug: ABS plastic (gray) Gasket: Chloroprene rubber Locking ring: diecast zinc	OBP-11	OBP-11	1	<ul style="list-style-type: none"> <li>Tightening torque: 1.2 N-m.</li> <li>Degree of protection: IP65 (when there is no anti-rotation ring hole)</li> <li>Supplied with a locking ring.</li> </ul> 
 <p>For TWN/TWND</p>	Plug: ABS plastic (gray) Gasket: Chloroprene rubber Locking ring: diecast zinc	OB-11	OB-11	1	<ul style="list-style-type: none"> <li>Tightening torque: 1.2 N-m.</li> <li>Degree of protection: IP65 (when there is no anti-rotation ring hole)</li> <li>Supplied with a locking ring.</li> </ul> 



- APEM
- Switches & Pilot Lights
- Control Boxes
- Emergency Stop Switches
- Enabling Switches
- Safety Products
- Explosion Proof
- Terminal Blocks
- Relays & Sockets
- Circuit Protectors
- Power Supplies
- LED Illumination
- Controllers
- Operator Interfaces
- Sensors
- AUTO-ID
- Flush Silhouette
- ø16
- ø22
- ø30
- Miniature
- Pilot Lights
- TWN
- TWND
- ARN
- CS





Accessories

All dimensions in mm.

Shape	Material	Part No.	Ordering No.	Package Quantity	Remarks
 ø35/ø26, height 9 For TWN/TWND	Metal (diecast zinc: chrome-plated)	OG-11	OG-11PN02	2	<ul style="list-style-type: none"> <li>Cannot be used with pin lock, selector pushbuttons, and monolever units.</li> </ul>
 ø35/ø26, height 9 For TWN	Polycarbonate	OGP-11*	OGP-11*PN02	2	<ul style="list-style-type: none"> <li>Specify a color code in place of *. B (black), G (green), R (red), W (white), Y (yellow)</li> <li>Cannot be used with pin lock, selector pushbuttons, and monolever units.</li> </ul>
 ① For TWDN	Metal (diecast zinc: chrome-plated)	OG-81	OG-81PN02	2	<ul style="list-style-type: none"> <li>Use with TWDN series diecast zinc switches and pilot lights.</li> <li>Cannot be used with half-shrouds.</li> </ul>
 ② For TWDN		OG-82	OG-82	1	
 ø35, height 14 For TWN	Acrylic (clear)	OGP-13	OGP-13PN02	2	<ul style="list-style-type: none"> <li>Clear plastic full shroud.</li> </ul>
 ø35, height 20.6 For TWN	Acrylic (clear)	OGP-14	OGP-14PN02	2	
 Shroud: ø35, height 20.6 Metal Nut Ring: height 4 For TWN	Acrylic (clear)	OGP-1411	OGP-1411	1	<ul style="list-style-type: none"> <li>Buttons may protrude slightly depending on the panel thickness.</li> </ul>
 ø35, height 4 For TWN	Metal (diecast zinc)	OL-11	OL-11PN05	5	<ul style="list-style-type: none"> <li>Metal nut ring for OGP-1411 only.</li> </ul>

- APEM
- Switches & Pilot Lights
- Control Boxes
- Emergency Stop Switches
- Enabling Switches
- Safety Products
- Explosion Proof
- Terminal Blocks
- Relays & Sockets
- Circuit Protectors
- Power Supplies
- LED Illumination
- Controllers
- Operator Interfaces
- Sensors
- AUTO-ID

- Flush Silhouette
- ø16
- ø22
- ø30
- Miniature
- Pilot Lights

- TWN
- TWND
- ARN
- CS

## Accessories

All dimensions in mm.

Shape	Material	Part No.	Ordering No.	Package Quantity	Color Code *		
Button for Pushbuttons ①  ②  ③  ④  ⑤  ⑥  ⑦  For TWN/TWND	Polyacetal	① Flush ø24.6, height 4	ABN1BN-*	ABN1BN-*	5	B (black), G (green), R (red), Y (yellow), S (blue), W (white)	
		② Extended ø24.6, height 9	ABN2BN-*	ABN2BN-*	5		
		③ Mushroom ø40, height 16.2	ABN3BN-*	ABN3BN-*	2		
		④ Jumbo Mushroom ø65, height 23.2	ABN4BN-*	ABN4BN-*	1		B (black), G (green), R (red), Y (yellow), S (blue)
		⑤ Button for Pin Lock (ABD8P) ø23.6, height 3	ABW1B-*	ABW1B-*	5		B (black), G (green), R (red), Y (yellow), S (blue), W (white)
	AS resin	⑥ ø40 Pushlock Turn Reset (AVN3, AVD3) ø40, height 18.5	AVN3B-*	AVN3B-*	1	R (red), Y (yellow)	
		⑦ ø40 Push Turn Lock (AJN3, AJD3) ø40, height 18.5	AJN3B-*	AJN3B-*	1	B (black), G (green), R (red), Y (yellow)	
Lens for Illuminated Pushbuttons ①  ②  For TWN/TWND	AS resin	① Extended (ALN2, ALD2) ø24, height 18.5	ALN2LD-**-K	ALN2LD-**-KPN05	5	R (red), G (green), S (blue), Y (yellow), A (amber), W (white) Specify W for PW (pure white) illumination.	
		② ø40 Pushlock turn reset (AVLN3, AVL3D3) ø40, height 18.5	AVLN3L-R-K	AVLN3L-R-KPN02	2	R (red) only	
Selector Operator ①  ②  ③  ④  For TWN/TWND	Polyacetal	① Knob operator ø25, height 20.5	ASNHT-*	ASNHT-*	2	B (black), G (green), R (red)	
		② Lever operator ø25, height 20.5, length 37.5	ASNHL-*	ASNHL-*			
		③ Color insert Width 21, depth 5, height 18	TW-HC1*	TW-HC1*	5	B (black), G (green), R (red), Y (yellow), S (blue), W (white)	
	AS resin	④ Knob for illuminated selector switch (ASLN, ASLD) ø25, height 28	ASLNHD-**-K	ASLNHD-**-K	1	G (green), R (red), S (blue), A (amber), W (white), Y (yellow) Specify W for PW (pure white) illumination.	
Lens for Pilot Lights ①  ②  ③  For TWN	AS resin	① Round (APN1, APD1) ø24.6, height 28, M20 For TWN/TWND	APN106LN-**-K	APN106LN-**-KPN05	5	R (red), G (green), Y (yellow) A (amber), W (white), S (blue) Specify W for PW (pure white) illumination.	
		② Rectangular (UPQN4) Width 36, depth 30, height 8.5 For TWN	UPQN406LD-**-K	UPQN406LD-**-KPN05	5	R (red), G (green), Y (yellow), A (amber), C (clear), S (blue) Specify C for PW (pure white) illumination.	
		③ Square extended (UPQN3B) □25, height 26.5 For TWN	UPQN06LD-**-K	UPQN06LD-**-KPN05	5	R (red), G (green), S (blue), Y (yellow), A (amber), W (white) Specify W for PW (pure white) illumination.	
Marking Plate  For TWN	Acrylic	UPQN406N-W	UPQN406N-WPN05	5	W (white) only See B-346 for engraving area.		

Maintenance Parts

All dimensions in mm.

Shape	Material	Part No.	Ordering No.	Package Quantity	Remarks
<p>Rubber Washer (1.5 mm-thick) For TWN/TWND</p>	Rubber (synthetic soft vinyl) ø39/ø29.5, height 1.5	OW-11	OW-11PN10	10	• To tighten mounting panels
<p>Rubber Washer (3.0 mm-thick) For TWN/TWND</p>	Rubber (synthetic soft vinyl) ø39/ø29.5, height 3	OW-12	OW-12PN10	10	• To tighten mounting panels
<p>Shroud for Pushbuttons</p> <p>① ② ③ ④ ⑤</p> <p>For TWN/TWND</p>	① Half shroud ø35/ø27, height 20.5	ABN2G	ABN2G	1	• With nut ring (ø35, height 4)
	② Full shroud ø35/ø28.5, height 16.5	ABN2F	ABN2F	1	
	③ Full shroud (for mushroom pushbuttons) ø48, height 20	ABN3G	ABN3G	1	
	④ Shallow shroud (for jumbo mushroom) ø75, height 18	ABN4G	ABN4G	1	
	⑤ Deep shroud (for jumbo mushroom) ø75/ø69, height 33	ABN4F	ABN4F	1	
<p>Shroud for Illuminated Pushbuttons</p> <p>① ②</p> <p>For TWN/TWND</p>	① Half shroud (For BA9S base) ø35/ø27, height 25	ALN2GL	ALN2GL	1	• With nut ring (ø35, height 4)
	② Full shroud (For BA9S base) ø35/ø29.5, height 22.5	ALN2FL	ALN2FL	1	• With nut ring (ø35, height 4)
<p>Spare Key For Key Selector Switches</p> <p>For TWN/TWND</p>	Metal Nickel plated brass Length 3, width 19.7, thickness 1.8	TW-SK-0	TW-SK-0PN02	2	• ASN□K□N ASD□K□N
<p>Spare Key For Key Selector Switches</p> <p>For TWN</p>	Metal Nickel plated brass Length 37.5, thickness 2	ASN-SK-24401	ASN-SK-24401PN02	2	• ASN□K□-N024401
<p>Pin/Chain Kit For ABD8P</p> <p>For TWND</p>	Pin: Nickel plated brass	ABD8P-PIN	ABD8P-PIN	1	• Pin, chain, and plate for ABN8P • Pin (ø4.6)
<p>Contact Block Plug</p> <p>For TWN/TWND</p>	Polyamide	HW9Z-CBPL	HW9Z-CBPLPN10	10	• Used to plug the hole in the center of a contact block.

APEM

Switches & Pilot Lights

Control Boxes

Emergency Stop Switches

Enabling Switches

Safety Products

Explosion Proof

Terminal Blocks

Relays & Sockets

Circuit Protectors

Power Supplies

LED Illumination

Controllers

Operator Interfaces

Sensors

AUTO-ID

Flush Silhouette

ø16

ø22

ø30

Miniature

Pilot Lights

TWN

TWND

ARN





CS



Download catalogs and CAD from <http://eu.idec.com/downloads>



## Maintenance Parts

All dimensions in mm.

Shape	Description	Part No.	Ordering No.	Package Quantity	Remarks
 For TWN/TWND, 11g approx.	NO contact	HW-U10	HW-U10	1	Housing color: Blue Push rod color: Green MAU has gold contacts
		HW-U10-MAU	HW-U10-MAU		
	NC contact	HW-U01	HW-U01	1	Housing color: Reddish purple Push rod color: Red MAU has gold contacts
		HW-U01-MAU	HW-U01-MAU		
	EM contact (early make)	HW-U10R	HW-U10R	1	Housing color: Blue Push rod color: Black MAU has gold contacts
		HW-U10R-MAU	HW-U10R-MAU		
LB contact (late break)	HW-U01R	HW-U01R	1	Housing color: Reddish purple Push rod color: White MAU has gold contacts	
	HW-U01R-MAU	HW-U01R-MAU			
 For TWN/TWND 3.5g approx.	Polyamide	HW-DB	HW-DBPN10	10	<ul style="list-style-type: none"> <li>For HW-U contact blocks</li> <li>Used when the number of contact blocks and full voltage adapters is 1 or 3.</li> </ul>
 For Illuminated Switches (*1) For TWN/TWND 12g approx.	Polyamide	HW-GA1N	HW-GA1NPN02	2	<ul style="list-style-type: none"> <li>Applicable model: Illuminated pushbuttons Illuminated selector switches</li> <li>Applicable load (LED lamp) LSRD-6, LSTD-6 (6V AC/DC) LSRD-1, LSTD-1 (12V AC/DC) LSRD-2, LSTD-2 (24V AC/DC)</li> </ul>
 For Illuminated Switches (*1) For TWN/TWND 66g approx.	100/110V AC	HW-T16	HW-T16	1	<ul style="list-style-type: none"> <li>Applicable model: Illuminated pushbuttons Illuminated selector switches</li> <li>Applicable load (LED lamp) LSRD-6, LSTD-6 (6V AC/DC)</li> </ul>
	200/220V AC	HW-T26	HW-T26	1	
 For Pilot Lights (*1) For TWN/TWND 69g approx.	100/110V AC	TWR-016B	TWR-016B	1	<ul style="list-style-type: none"> <li>Mounting screws are not included.</li> <li>See <b>B-347</b> for mounting screws.</li> <li>Applicable load (LED lamp) LSRD-6, LSTD-6 (6V AC/DC)</li> </ul>
	200/220V AC	TWR-026B	TWR-026B	1	

\*1) For use as maintenance parts. Do not use for expansion or remodelling purposes.

## LED Lamps (Use LED lamps for replacing incandescent lamps)

Model	Operating Voltage	Current Draw		Part No.	Ordering No.	Color Code	Package Quantity	Base
		DC	DC					
 LSRD	6V AC/DC	10mA	14mA	LSRD-6	LSRD-6	—	1	BA9S /13
					LSRD-6PN10		10	
	12V AC/DC	7mA	8mA	LSRD-1	LSRD-1		1	
					LSRD-1PN10		10	
24V AC/DC	7mA	8mA	LSRD-2	LSRD-2	1			
				LSRD-2PN10	10			
 LSTD	6V AC/DC	7mA (R, A, W) 5.5mA (G, PW) 4.5mA (S)	8mA (except S) 7mA (S)	LSTD-6*	LSTD-6*	R, G, A, W, S, PW	1	BA9S /13
					LSTD-6*PN10		10	
	12V AC/DC	10mA (except S) 8mA (S)	11mA (except S) 9mA (S)	LSTD-1*	LSTD-1*		1	
					LSTD-1*PN10		10	
	24V AC/DC	10mA (except S) 8mA (S)	11mA (except S) 9mA (S)	LSTD-2*	LSTD-2*		1	
					LSTD-2*PN10		10	
 LETD	6V AC/DC	14mA (R, A, W) 5.5mA (G, S, PW)	17mA (R, A, W) 8mA (G, S, PW)	LETD-6*	LETD-6*	R, G, A, W, S, PW	1	E12 /15
					LETD-6*PN10		10	
	12V AC/DC	6.5mA (10mA: at 15V)	7mA (11mA: at 15V)	LETD-8*	LETD-8*		1	
					LETD-8*PN10		10	
	24V AC/DC	10mA	11mA	LETD-2*	LETD-2*		1	
					LETD-2*PN10		10	



- Only one color is available for LSRD so there are no codes to specify the color in the part no.
- Specify a color code in place of \* in Part No. R (red), G (green), A (amber), W (white), S (blue), PW (pure white)
- Use a PW (pure white) LED for Y (yellow) illumination.
- When replacing the LED with LSRD, the lens must also be replaced (see **B-341**).



Maintenance Parts

All dimensions in mm.

LED lamps for replacing incandescent lamps

Incandescent Lamp				
Model (mm)	Part No.	Operating Voltage	Lamp Rating	Base
 Bulb: ø11 Length: 23	LS-6	6V AC/DC	1W (6V)	BA9S /13
	LS-8	12V AC/DC	1W (18V)	
	LS-2	18V AC/DC	1W (24V)	
 Bulb: ø13 Length: 34	LS-3	24V AC/DC	1W (30V)	E12 /15
	LE-6	6V AC/DC	2W (6V)	
	LE-8	12V AC/DC	2W (18V)	
	LE-2	18V AC/DC	2W (24V)	
	LE-3	24V AC/DC	2W (30V)	





Replacement LED Lamp			
Part No.	Color Code	Operating Voltage	Base
LSRD-6	—	6V AC/DC	BA9S /13
LSRD-1		12V AC/DC	
LSRD-2		24V AC/DC	
LETD-6*	R, G, A, S, PW	6V AC/DC	E12 /15
LETD-8*		12V AC/DC	
LETD-2*		24V AC/DC	
LETD-2*		24V AC/DC	

- When using a commercially available incandescent lamp, choose a lamp with the same dimensions, operating voltage, and base.
- Specify a color code in place of \* in Part No.  
R (red), G (green), A (amber), S (blue), PW (pure white)
- Use a PW (pure white) LED lamp for Y (yellow) illumination.
- For O (orange) and C (clear) color code of incandescent lamp, use A (amber) LED lamp.

- Only one color is available for LSRD so there are no codes to specify the color in the part no.
- When replacing incandescent lamps to LSRD, the lens must also be replaced (see B-341).

Transformer

Shape	Operating Voltage	Voltage Range	Part No. (Ordering No.)	Applicable Load
 For 6V	100/110V AC	±10%	TWR516	LSRD-6, LSTD-6* (6V AC/DC, LED lamp)  Specify a color code in place of * in Part No. R (red), G (green), A (amber), S (blue), PW (pure white)
	200/220V AC	±10%	TWR526	
	400/440V AC	±10%	TWR546	
 For 24V	100/110V AC	±10%	TWR512	LSRD-2, LSTD-2* (24V AC/DC, LED lamp)  Specify a color code in place of * in Part No. R (red), G (green), A (amber), S (blue), PW (pure white)
	200/220V AC	±10%	TWR522	
	400/440V AC	±10%	TWR542	

- Terminal cover (TWR-VL3) is installed on transformers as standard.

Specifications



Part No.	TWR5□6	TWR5□2
Rated Voltage	100/110V AC, 200/220V AC, 400/440V AC (50/60 Hz)	
Current Draw	2.4VA	
Rated Insulation Voltage	600V	
Insulation Resistance	100MΩ minimum (500V DC megger)	
Operating Temperature	-30 to 60°C (no freezing)	
Operating Humidity	35 to 85% RH (no condensation)	
Storage Temperature	-40 to +80°C (no freezing)	
Vibration Resistance	Damage limits: 30 Hz, amplitude 1.5 mm Operating extremes: 5 to 55 Hz, amplitude 0.5 mm	
Shock Resistance	1000 m/s <sup>2</sup> 100 m/s <sup>2</sup>	
Dielectric Strength	2500V AC, 1 minute	
Terminal Screw	M3.5	
Applicable Wire	2 mm <sup>2</sup> maximum, 2 wires maximum	
Weight	87g	

Dimensions

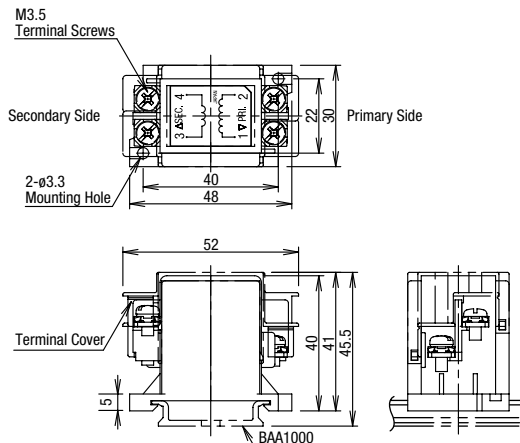
All dimensions in mm.

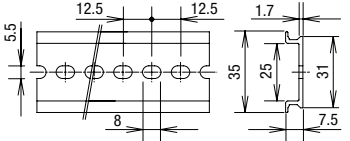

Accessories

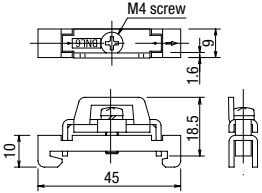
Shape	Material	Part No.	Ordering No.	Package Quantity	Dimensions (mm)
 Weight: 200g approx.	Aluminum Length: 1000 mm	BAA1000	BAA1000PN10	10	
 Weight: 15g approx.	Metal (zinc-plated steel)  Applicable rail: BAA1000 BAP1000	BNL6	BNL6PN10	10	

- See H-071 for DIN rail products.



Download catalogs and CAD from <http://eu.idec.com/downloads>

APEM

Switches & Pilot Lights

Control Boxes

Emergency Stop Switches

Enabling Switches

Safety Products

Explosion Proof

Terminal Blocks

Relays & Sockets

Circuit Protectors

Power Supplies

LED Illumination

Controllers

Operator Interfaces

Sensors

AUTO-ID

Flush Silhouette

ø16

ø22

ø30

Miniature

Pilot Lights

TWN

TWND

ARN

CS

## Safety Precautions

- Turn off the power to the TWN/TWND switches & pilot lights before starting installation, removal, wiring, maintenance, and starting installation, removing, wiring, maintenance, and inspection of the products. Failure to turn power off may cause electrical shocks or fire hazard.
- To avoid a burn on your hand, use the lamp holder tool when replacing lamps.
- For wiring, use wires of a proper size to meet the voltage and current requirements. Tighten the terminal screws to the recommended tightening torque (see B-349). Failure to tighten terminal screws may cause overheating and fire.

- When using a commercially available lamp, choose a lamp with rated voltage 5 to 30V AC/DC and 1W maximum, and with the same base and shape. Make sure of correct operation before installation. The operation of illuminated pushbutton switches cannot be guaranteed when a commercially available lamp is used.

## Operating Instructions

### Panel Mounting

1. Remove the locking ring from the operator and check that the rubber gasket is in place. For mushroom and jumbo mushroom switches, remove the button before removing the locking ring.
2. Adjust the thickness of the rubber washers according to the panel thickness.
3. Insert the switch into the panel from the back of the panel.
4. On the panel front, install the nameplate and locking ring. For mushroom and jumbo mushroom switches, install the button before installing the locking ring.

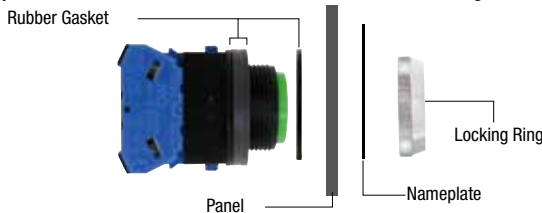

### Panel Thickness and Rubber Washer

Adjust the thickness of the rubber washers according to the panel thickness as shown in the tables below. Also, make sure to include the nameplate thickness when using a nameplate.



### Applicable Model

#### TWN/TWND series

Pushbutton  
(flush/extended/mushroom/jumbo mushroom)  
Illuminated pushbutton (extended/mushroom)  
Pilot light (except for square type)

Panel Thickness (mm)	Rubber Washer	
	1.5 mm-thick	3.0 mm-thick
Supplied	2 pieces	1
0.8 to 3.5	2 pieces	1
3.5 to 5.0	1	1
5.0 to 6.5	–	1
6.5 to 7.5	1	–

#### TWN/TWND series

Illuminated pushbutton (extended w/full shroud)  
Mushroom with full shroud

Panel Thickness (mm)	Rubber Washer	
	1.5 mm-thick	3.0 mm-thick
Supplied	2 pieces	1
0.8 to 3.5	2 pieces	1
2.0 to 3.5	1	1
3.5 to 5.0	–	1
5.0 to 6.0 (6.5)*1	1	–

\*1: (6.5) is for mushroom pushbuttons with full shroud

#### TWND series

Pin lock pushbutton

Panel Thickness (mm)	Rubber Washer	
	1.5 mm-thick	3.0 mm-thick
Supplied	2 pieces	1
0.8 to 3.0	2 pieces	1
3.0 to 4.5	1	1
4.5 to 6.0	–	1
6.0 to 7.5	1	–

#### TWN/TWND series

Pushbutton (extended with half shroud)  
Illuminated pushbutton  
(extended with half shroud)

Panel Thickness (mm)	Rubber Washer	
	1.5 mm-thick	3.0 mm-thick
Supplied	1	1
0.8 to 1.8	–	1
1.8 to 3.5	1	–

#### TWN/TWND series

Pushbutton (extended with full shroud)

Panel Thickness (mm)	Rubber Washer	
	1.5 mm-thick	3.0 mm-thick
Supplied	2 pieces	1
0.8 to 2.5	2 pieces	1
2.5 to 4.0	1	1
4.0 to 5.5	–	1
5.5 to 6.0	1	–

#### TWN/TWND series

Other models (excluding square)

Panel Thickness (mm)	Rubber Washer	
	1.5 mm-thick	3.0 mm-thick
Supplied	2 pieces	1
0.8 to 3.5	2 pieces	1
3.5 to 5.0	1	1
5.0 to 6.5	–	1
6.5 to 7.5	1	–

- See B-324 for square pilot lights about installing on the panel and replacing LED lamps.
- The number of rubber washers shown in the dimensions of TWN/TWND series may differ from the number of rubber washers supplied.

### Notes for Panel Mounting

#### Locking ring wrench recommended torque

Tighten the bezel to a tightening torque of 3.0 to 3.5 N·m.

#### Locking ring wrench

Locking ring wrench (OR-12) can be used to tighten the bezel. Use side B to tighten. Side B: For TWN/TWND series  
Side A: TWS series

Locking ring wrench (OR-12)



### Installing the Anti-rotation Ring (OGL-11)

Anti-rotation rings are used on selector switches or pushbuttons which rotate and used when using no nameplates. Insert a 1.5 mm-thick rubber washer between the panel and the anti-rotation ring as shown on the right.

To install, adjust the panel thickness by taking the thickness of anti-rotation ring (OGL-11) into consideration.

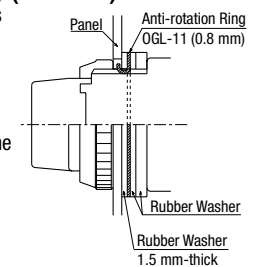

### Replacement of LED Lamps

Lamps can be replaced by using the lamp holder tool (OR-55) from the front of the panel. (See B-338 for lamp holder tool.)

#### How to Remove

To remove, slip the lamp holder tool onto the lamp head lightly. Then push slightly, and turn the lamp holder tool counterclockwise.



#### How to Install

To install, insert the lamp head into the lamp holder tool. Place the two pins on the lamp base to the grooves in the lamp socket. Inset the lamp and turn it clockwise.

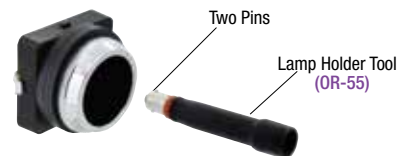

APEM

Switches & Pilot Lights

Control Boxes

Emergency Stop Switches

Enabling Switches

Safety Products

Explosion Proof

Terminal Blocks

Relays & Sockets

Circuit Protectors

Power Supplies

LED Illumination

Controllers

Operator Interfaces

Sensors

AUTO-ID

Flush Silhouette

ø16

ø22

ø30

Miniature

Pilot Lights

TWN

TWND

ARN

CS

CS

CS

CS

CS

CS

CS

CS

CS

CS

CS

CS

CS

CS

CS

CS

CS

CS

CS

CS

CS

CS

CS

CS

CS

## Operating Instructions

### Installing/Removing the Buttons and Lenses

To install

To remove

#### Pushbutton button

##### Flush/Extended

Push in the button to install.



Insert a flat screwdriver between the button and the bezel to remove the button (see below for details).



<Notches>

#### Notches on the operating shaft

The operating shaft has four notches as shown at right. Insert a flat screwdriver (3 mm max.) into one of the notches, and tilt the screwdriver to remove the button.



**⚠** Make sure to insert a flat screwdriver into one of the notches, otherwise the pushbutton may be damaged.

#### Notes on button removal

To avoid damaging the bezel or the button, remove the bezel from the pushbutton before inserting a flat screwdriver.

#### Mushroom/Jumbo Mushroom

Button has threads. Turn clockwise to install the button.



Turn the button counterclockwise to remove.



#### Illuminated Pushbutton Lens

Extended/Mushroom  
Lens has threads. Turn clockwise to install the lens.



Turn the lens counterclockwise to remove.



#### Pilot Light Lens Round

Lens has threads. Turn clockwise to install the lens.



Turn the lens counterclockwise to remove.



**⚠** A rubber gasket is installed between the lens and operator on pilot lights. Make sure that the rubber gasket is in place when installing the lens.

### Marking Plate on Pilot Lights

#### Rectangular Marking Plates (for UPQN4)

##### Removing

① Insert a flat screwdriver between the lens and bezel, and tilt the screwdriver to remove the lens.



② A white marking plate is installed in the lens which can be removed easily.



##### Engraving Area

Material: Acrylic resin  
Size: 29.8 W × 23.8 D, thickness 2.0 mm  
Engraving area: 28 W × 22 D × 1.0 mm height max.

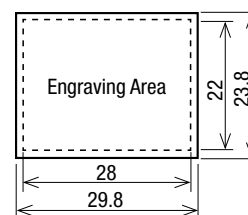

### Installing the Half Shroud on Extended Pushbuttons/Illuminated Pushbuttons

#### Half Shroud Parts

A shroud is installed in the shroud locking ring. Tightening the shroud locking ring in the switch locks the shroud.

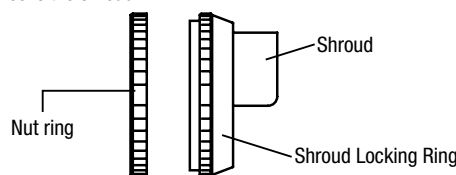

#### Installing the Half Shroud

- Adjust the thickness of the rubber washers according to the panel thickness (see B-345).
- Insert the switch into the panel from the back of the panel.
- Install the nut ring from the panel front to tighten the switch.
- Install the half shroud on the upper side of the switch, and tighten the shroud locking ring.
- Make sure that the shroud is securely fastened inside the shroud locking ring.

#### Tightening the Half Shroud

Align the three projections on the shroud with the groove on the switch, and tighten the shroud on the upper side of the switch. Tighten the shroud locking ring.

- Three projections on the shroud
- Grooves on the threads
- Complete



- ⚠**
- Shrouds may rattle depending on the panel thickness.
  - A gap may appear between the nut ring and the shroud locking ring depending on the panel thickness.

## Operating Instructions

## Selector Switches

Turn the operator such as knob, lever, and key to each position accurately. Releasing halfway may cause the operator to return to the former position, or to get stuck between. On spring return two-way types, the center of operators may be misaligned slightly.

## Key Selector Switches

Insert the key completely before turning. Failure to do so may cause failures.

## Installing the Operator on Selector Switches

① Install the switch with TOP marking facing upward, so that the operator can be installed on the switch in the correct direction.



② On non-illuminated models, install the color insert in the middle of operator. The color insert also serves to retain the operator.



③ On illuminated models, align the operator with the switch by confirming the TOP marking on the switch and also the switch operation. Then press in the operator into the switch.



## Installation of Selector Operators

The shaft of each non-illuminated selector switch has a recess to identify in which direction to install the operator. Align the operator with the recess and press in the operator. Press a color insert (non-illuminated) into the operator (illuminated selector switches do not have a recess on the shaft).

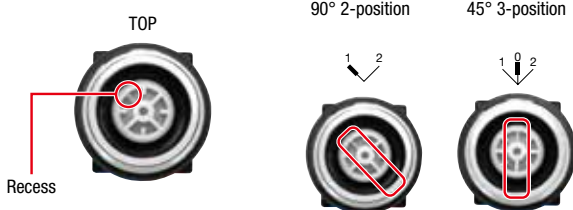

The non-illuminated operators can be installed in positions other than the standard position shown above.

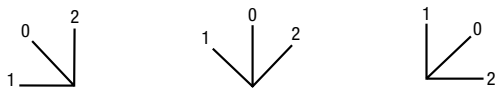

Standard positions

## Removal

## Removing the Operator from Selector Switches



① Insert a flat screwdriver into the recess under the color insert. Turn the screwdriver to push out the insert from the operator.

② Pull out the operator sideways as shown in the left photo to remove the operator.

## Removing the Operator from Illuminated Selector Switches



① Insert a flat screwdriver (4 to 5 mm) into the recess at right or left under the operator and tilt. The operator is displaced slightly.

② Insert the flat screwdriver into the other recess and tilt. The operator can be removed.

## Removing the Contact Blocks/Full Voltage Adapters

Insert a flat screwdriver (4 to 6 mm) into the snap-fit latches of the contact block or full voltage adapter and lift to remove.

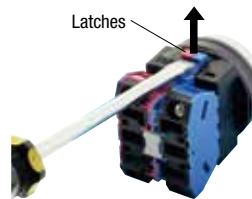

- Make sure to lift both latches. Contact blocks cannot be removed by lifting one latch only.
- Do not apply excessive force to the latches, otherwise damage may be caused.

## Transformer Units and DC-DC Converters

Insert the end of the contact block removal tool (TW-KC1) into the snap-fit latch of the transformer units or DC-DC converter and pull the tool forward.

The contact block removable tool cannot be used to remove the HW-U contact blocks or full voltage adapters.

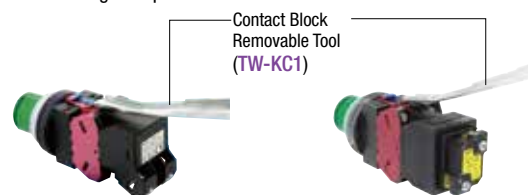

⚠ When replacing parts (contact block, dummy block, full voltage adapter, transformer) for maintenance, make sure to install the parts to the original position. Otherwise proper operation cannot be guaranteed.

## Transformer Units and DC-DC Converters for Pilot Lights

Unfasten the two mounting screws on the back to remove the transformer unit/DC-DC converter.



Mounting screws  
APN: M3 × 6 (screw diameter ø5.5 or below)  
APD: M3.5 × 6 (screw diameter ø5.5 or below)

APEM
Switches & Pilot Lights
Control Boxes
Emergency Stop Switches
Enabling Switches
Safety Products
Explosion Proof
Terminal Blocks
Relays & Sockets
Circuit Protectors
Power Supplies
LED Illumination
Controllers
Operator Interfaces
Sensors
AUTO-ID
Flush Silhouette
ø16
ø22
ø30
Miniature
Pilot Lights
TWN
TWND
ARN
CS

Operating Instructions

Applicable Wiring

(1) Contact Block 0.3 to 3.5 mm<sup>2</sup> (solid wire 0.5 to 2.0 mm)

Pushbutton/illuminated pushbutton/selector switch/illuminated selector switch/selector pushbutton

(A) and (B) show the wiring direction to the terminals.

<Contact Block>

Terminal screws M3.5 (spring-up)

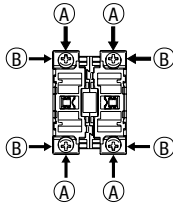

Applicable Crimping Terminal

Be sure to use an insulation tube or cover on the crimping part of the crimping terminal to prevent electrical shocks.

Crimping terminal for (A)

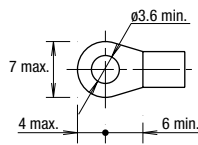
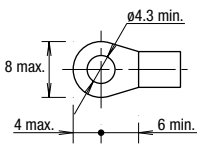

IP20 crimping terminal

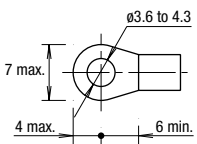

Crimping terminal for (B)  
IP20 crimping terminal

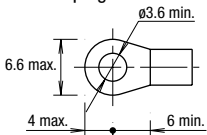

Solid wire

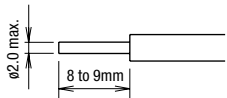

- Strip the wire insulation 8 to 9 mm from the end.
- Insert the wire until the insulation comes into contact with the terminal metal part.

(1)-1 IP20 Degree of Protection

The terminal of HW-U contact block has IP20 degree of protection. When IP20 is required for wiring, observe the followings.

Make sure to insert the crimping terminal or wire to the terminal straight and fully.

When using a crimping terminal

Use IP20 crimping terminals.

When using a solid wire

Strip the wire insulation 8 to 9 mm from the end and insert the wire to the terminal fully.

When using a stranded wire

Strip the wire insulation 8 to 9 mm from the end and insert the wire to the terminal fully. Make sure that the wires are not loosened.

(2) Power Unit 0.3 to 2 mm<sup>2</sup> (solid wire 0.5 to 1.6 mm)

illuminated pushbutton/illuminated selector switch

(A) and (B) show the wiring direction to the terminals.

<Full Voltage Adapter>

Terminal screws M3.5 (spring-up)

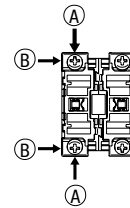

<Transformer Unit>

100/110V AC, 200/220V (240V AC or below)  
Terminal screws M3.5 (spring-up)

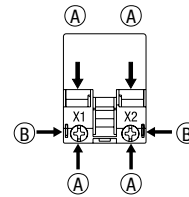

<DC-DC Converter Unit/Transformer Unit>

110V DC, 380V  
Terminal screws M3.5 (spring-up)

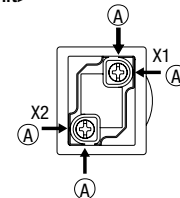

Applicable Crimping Terminal

Be sure to use an insulation tube or cover on the crimping part of the crimping terminal to prevent electrical shocks.

Crimping terminal for (A)

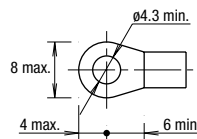

Crimping terminal for (B)

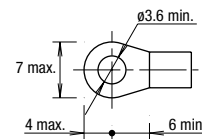

Solid wire

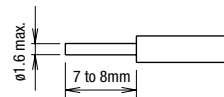

- Strip the wire insulation 7 to 8 mm from the end.
- Insert the wire until the insulation comes into contact with the terminal metal part.

- Terminal cover is integrated in the full voltage adapter and transformer unit. Note that the connection terminal is not IP20.





## Operating Instructions

**(3) Pilot Light** 0.3 to 2 mm<sup>2</sup> (solid wire 0.5 to 1.6 mm)**Applicable crimping terminal**

Be sure to use an insulation tube or cover on the crimping part of the crimping terminal to prevent electrical shocks.

**APN1, UPQN3B, UPQN4 (6, 12, 24V AC/DC)**

Terminal screws M3 (self-lifting)

(Arrows show the wiring direction)

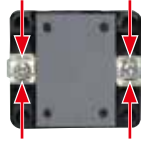
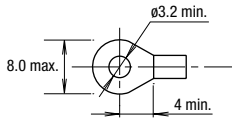
**APD1 (6, 12V, 24V AC/DC)**

Terminal screws M3.5 (self-lifting)

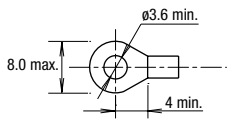
**APN1, UPQN3B, UPQN4, APD1 (100 to 480V AC or below, 110V DC)**

Terminal screws M3.5 (self-lifting)

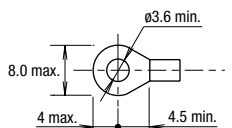

- Install the terminal cover supplied with the pilot light. The connection terminal is not IP20.
- When selecting mounting centers and crimping terminals, take sufficient insulation distance into consideration.

## Cautions for Wiring

**About using DC-DC Converter Unit**

1. Note the polarity for wiring when connecting to the DC-DC converter.

Terminal No.	Polarity
X1	Positive
X2	Negative

2. Incandescent lamps cannot be used in DC-DC converter unit.
3. DC-DC converters are equipped with an electric circuit and noise may be heard inside the unit, which does not affect the performance of DC-DC converters.

## Recommended Tightening Torque

## Number of Wires

Unit	Wire	Number of Wires	Recommended Tightening Torque (Nm)	Terminal Screw	
HW-U Contact Block	Crimping Terminal		2	1.0 to 1.3	M3.5
	Solid Wire	ø0.5 to 1.6 mm (AWG14 to 22)	2	1.0 to 1.3	
		ø1.7 to 2.0 mm (AWG12)	1	1.2 to 1.3	
	Stranded Wire	0.3 to 2.0 mm <sup>2</sup> (AWG14 to 22)	2	1.0 to 1.3	
2.1 to 3.5 mm <sup>2</sup> (AWG12)		1	1.2 to 1.3		
Illuminated Unit (*1)	Crimping Terminal		2	1.0 to 1.3	M3.5
	Solid Wire	ø0.5 to 1.6 mm (AWG14 to 22)			
Pilot Light	Crimping Terminal		2	0.6 to 1.0 (M3.0)	
	Solid Wire	ø0.5 to 1.6 mm (AWG14 to 22)			
	Stranded Wire	0.3 to 2.0 mm <sup>2</sup> (AWG14 to 22)			1.0 to 1.3 (M3.5)

\*1) Lamp terminal of illuminated pushbuttons and illuminated selector switches

APEM

Switches &amp; Pilot Lights

Control Boxes

Emergency Stop Switches

Enabling Switches

Safety Products

Explosion Proof

Terminal Blocks

Relays &amp; Sockets

Circuit Protectors

Power Supplies

LED Illumination

Controllers

Operator Interfaces

Sensors

AUTO-ID

Flush Silhouette

ø16

ø22

ø30

Miniature

Pilot Lights

TWN

TWND

ARN

CS



ø30 Selector Switches / Pushbuttons Part Number Replacement List

Old Series		New Part No. (*3)	Remarks	
Model	Operator			
ASN Knob Operator	90° 2-position	ASN310	ASN210N	
		ASN311	ASN211N	
		ASN320	ASN220N	
		ASN322	ASN222N	
		ASN37S	ASN22RN-118	
		ASN410	ASN2110N	
		ASN411	ASN2111N	
		ASN420	ASN2120N	
		ASN422	ASN2122N	
		ASN47S	ASN212RN-118	
		ASN3010	ASN201N	(*2)
		ASN3011	ASN211N	(*1)
		ASN3020	ASN202N	(*2)
		ASN3022	ASN222N	(*1)
		ASN307S	ASN22RN-118	(*1)
		ASN4010	ASN2210N	
		ASN4011	ASN2211N	
	ASN4020	ASN2220N		
	ASN4022	ASN2222N		
	ASN407S	ASN222RN-168		
	45° 3-position	ASN111	ASN320N	(*2)
		ASN122	ASN340N	(*2)
		ASN15S	ASN322N	
		ASN17S	ASN302N	(*1)
		ASN18S	ASN304N	(*1)
		ASN211	ASN3220N	(*2)
		ASN222	ASN3240N	(*2)
		ASN25S	ASN3222N	
		ASN27S	ASN3202N	(*1)
		ASN28S	ASN3204N	(*1)
		ASN1011	ASN320N	(*1) (*2)
		ASN1022	ASN340N	(*1) (*2)
		ASN105S	ASN322N	(*1)
ASN107S		ASN302N		
ASN108S		ASN304N		
ASN2011		ASN3120N	(*1) (*2)	
ASN2022	ASN3140N	(*1) (*2)		
ASN205S	ASN3122N	(*1)		
ASN207S	ASN3102N			
ASN208S	ASN3104N			
ASN-L Lever Operator	90° 2-position	ASN3L10	ASN2L10N	
		ASN3L11	ASN2L11N	
		ASN3L20	ASN2L20N	
		ASN3L22	ASN2L22N	
		ASN3L7S	ASN2L2RN-118	
		ASN4L10	ASN2L110N	
		ASN4L11	ASN2L111N	
		ASN4L20	ASN2L120N	
		ASN4L22	ASN2L122N	
		ASN4L7S	ASN2L12RN-118	
	45° 3-position	ASN30L10	ASN2L01N	(*2)
		ASN30L11	ASN2L11N	(*1)
		ASN30L20	ASN2L02N	(*2)
		ASN30L22	ASN2L22N	(*1)
		ASN30L7S	ASN2L2RN-118	(*1)
		ASN40L10	ASN22L10N	
		ASN40L11	ASN22L11N	
		ASN40L20	ASN22L20N	
		ASN40L22	ASN22L22N	
		ASN40L7S	ASN22L2RN-168	

Old Series		New Part No. (*3)	Remarks		
Model	Operator				
ASN-L Lever Operator	45° 3-position	ASN2L7S	ASN32L02N	(*1)	
		ASN2L8S	ASN32L04N	(*1)	
		ASN10L11	ASN3L20N	(*1) (*2)	
		ASN10L22	ASN3L40N	(*1) (*2)	
		ASN10L5S	ASN3L22N	(*1)	
		ASN10L7S	ASN3L02N		
		ASN10L8S	ASN3L04N		
		ASN20L11	ASN31L20N	(*1) (*2)	
		ASN20L22	ASN31L40N	(*1) (*2)	
		ASN20L5S	ASN31L22N	(*1)	
		ASN20L7S	ASN31L02N		
		ASN20L8S	ASN31L04N		
		ASN-K Key Selector	90° 2-position	ASN3K10□	ASN2K10N□-NO24401
				ASN3K11□	ASN2K11N□-NO24401
ASN3K20□	ASN2K20N□-NO24401				
ASN3K22□	ASN2K22N□-NO24401				
ASN3K7S□	ASN2K2RN□-118-NO24401				
ASN4K10	ASN21K10N-NO24401				
ASN4K11	ASN21K11N-NO24401				
ASN4K20	ASN21K20N-NO24401				
ASN4K22	ASN21K22N-NO24401				
ASN4K7S	ASN21K2RN-118-NO24401				
ASN30K10□	ASN2K01N□-NO24401			(*2)	
ASN30K11□	ASN2K11N□-NO24401			(*1)	
ASN30K20□	ASN2K02N□-NO24401			(*2)	
ASN30K22□	ASN2K22N□-NO24401			(*1)	
ASN30K7S□	ASN2K2RN□-118-NO24401			(*1)	
ASN40K10	ASN22K10N-NO24401				
ASN40K11	ASN22K11N-NO24401				
ASN40K20	ASN22K20N-NO24401				
ASN40K22	ASN22K22N-NO24401				
ASN40K7S	ASN22K2RN-168-NO24401				
45° 3-position	ASN1K11□		ASN3K20N□-NO24401	(*2)	
	ASN1K22□		ASN3K40N□-NO24401	(*2)	
	ASN1K5S□		ASN3K22N□-NO24401	(*1) (*2)	
	ASN1K7S□		ASN3K02N□-NO24401	(*1) (*2)	
	ASN1K8S□		ASN3K04N□-NO24401	(*1) (*2)	
	ASN2K11□		ASN32K20N□-NO24401	(*2)	
	ASN2K22□		ASN32K40N□-NO24401	(*2)	
	ASN2K5S□		ASN32K22N□-NO24401	(*1) (*2)	
	ASN2K7S□		ASN32K02N□-NO24401	(*1) (*2)	
	ASN2K8S□		ASN32K04N□-NO24401	(*1) (*2)	
	ASN10K11□		ASN3K20N□-NO24401	(*1) (*2)	
	ASN10K22□		ASN3K40N□-NO24401	(*1) (*2)	
	ASN10K5S□		ASN3K22N□-NO24401	(*1) (*2)	
	ASN10K7S□		ASN3K02N□-NO24401	(*2)	
	ASN10K8S□	ASN3K04N□-NO24401	(*2)		
	ASTN Knob Operator	90° 2-position	ASTN3211	ASN211N	
ASTN3222			ASN222N	(*1)	
ASTN4211			ASN2111N		
ASTN4222			ASN2122N	(*1)	
ASTN1122			ASN322N		
45° 3-position		ASTN1222	ASN322N-311		
		ASTN1340	ASN340N		
		ASTN1422	ASN322N-209		
		ASTN1520	ASN320N		
		ASTN1540	ASN340N	(*1)	

• □: Key removable position code. Specify the same code as the old series.

\*1) The location of contacts is different. In application for maintenance purpose, make sure of contact operation before wiring.

\*2) Contact operation is same as the old series, but contact type is different.

\*3) The knob operator is diecast zinc and has new shape. The knob operator can be installed at 45 degrees intervals.



Download catalogs and CAD from <http://eu.idec.com/downloads>

APEM

Switches & Pilot Lights

Control Boxes

Emergency Stop Switches

Enabling Switches

Safety Products

Explosion Proof

Terminal Blocks

Relays & Sockets

Circuit Protectors

Power Supplies

LED Illumination

Controllers

Operator Interfaces

Sensors

AUTO-ID

Flush Silhouette

ø16

ø22

ø30

Miniature

Pilot Lights

TWN

TWND

ARN

CS

B-350

## ø30 Selector Switches / Pushbuttons Part Number Replacement List

		Old Series		New Part No. (*3)	Remarks
Model	Operator	Old Part No.			
APEM	ASTN Knob Operator	45° 3-position	ASTN20422	ASN3122N-209	
			ASTN20520	ASN3120N	(*1)
			ASTN20540	ASN3140N	(*1)
			ASTN5120	ASN3320N	
			ASTN5122	ASN3322N	
			ASTN5222	ASN3322N-311	
			ASTN5111	ASN3311N-202	
Control Boxes Emergency Stop Switches Enabling Switches Safety Products Explosion Proof Terminal Blocks Relays & Sockets Circuit Protectors Power Supplies LED Illumination Controllers Operator Interfaces Sensors AUTO-ID	ASTN L Lever Operator	90° 2-position	ASTN32L11	ASN2L11N	
			ASTN32L22	ASN2L22N	(*1)
			ASTN42L11	ASN21L11N	
			ASTN42L22	ASN21L22N	(*1)
			ASTN11L22	ASN3L22N	
			ASTN12L22	ASN3L22N-311	
			ASTN13L40	ASN3L40N	
			ASTN14L22	ASN3L22N-209	
			ASTN15L20	ASN3L20N	(*1)
			ASTN15L40	ASN3L40N	(*1)
	ASTN K Key Selector	45° 3-position	ASTN16L11	ASN3L11N-303	
			ASTN16L22	ASN3L22N-310	
			ASTN21L22	ASN32L22N	
			ASTN22L22	ASN32L22N-311	
			ASTN20L122	ASN31L22N	
			ASTN20L22	ASN31L22N-311	
			ASTN204L22	ASN31L22N-209	
			ASTN205L20	ASN31L20N	(*1)
			ASTN205L40	ASN31L40N	(*1)
			ASTN51L20	ASN33L20N	
ASTN51L22	ASN33L22N				
ASTN52L22	ASN33L22N-311				
ASTN51L11	ASN33L11N-202				
Flush Silhouette ø16 ø22 ø30 Miniature Pilot Lights	ASTN K Key Selector	90° 2-position	ASTN32K11□	ASN2K11N□	
			ASTN32K22□	ASN2K22N□	(*1)
			ASTN42K11	ASN21K11N	
			ASTN42K22	ASN21K22N	(*1)
			ASTN11K22□	ASN3K22N□	
			ASTN12K22□	ASN3K22N□-311	
			ASTN13K40□	ASN3K40N□	
			ASTN14K22□	ASN3K22N□-209	
			ASTN15K20□	ASN3K20N□	(*1)
			ASTN15K40□	ASN3K40N□	(*1)
	ASTN K Key Selector	45° 3-position	ASTN16K11□	ASN3K11N□-303	
			ASTN16K22□	ASN3K22N□-310	
			ASTN21K22□	ASN3K22N□	
			ASTN22K22□	ASN3K22N□-311	
			ASTN201K22□	ASN31K22N□	
			ASTN202K22□	ASN31K22N□-311	
			ASTN204K22□	ASN31K22N□-209	
			ASTN205K20□	ASN31K20N□	(*1)
			ASTN205K40□	ASN31K40N□	(*1)
			ASTN51K20	ASN33K20N	
ASTN51K22	ASN33K22N				
ASTN52K22	ASN33K22N-311				
ASTN51K11	ASN33K11N-202				
ASN-T Knob Operator	45° 3-position	ASN120-T	ASN320N		
		ASN140-T	ASN340N		
		ASN220-T	ASN3220N		
		ASN240-T	ASN3240N		
		ASN2020-T	ASN3120N	(*1)	
		ASN2040-T	ASN3140N	(*1)	
		ASN1L20-T	ASN3L20N		
ASN-T Lever Operator	45° 3-position	ASN1L40-T	ASN3L40N		
		ASN2L20-T	ASN32L20N		
		ASN2L40-T	ASN32L40N		
		ASN20L20-T	ASN31L20N	(*1)	
		ASN20L40-T	ASN31L40N	(*1)	

- Specify a color code in place of \* in Part No. B (black), G (green), R (red), Y (yellow).
- : Key removable position code. Specify the same code as the old series.
- \*1) The location of contacts is different. In application for maintenance purpose, make sure of contact operation before wiring.
- \*2) Contact operation is same as the old series, but contact type is different.

		Old Series		New Part No. (*3)	Remarks
Model	Operator	Old Part No.			
ASTN K-T Key Selector	90° 2-position	ASN3K10□-T	ASN2K10N□		
		ASN3K11□-T	ASN2K11N□		
		ASN3K20□-T	ASN2K20N□		
		ASN3K22□-T	ASN2K22N□		
		ASN3K7S□-T	ASN2K2RN□-118		
		ASN4K10-T	ASN21K10N		
		ASN4K11-T	ASN21K11N		
		ASN4K20-T	ASN21K20N		
		ASN4K22-T	ASN21K22N		
		ASN4K7S-T	ASN21K2RN-118		
		ASN40K10-T	ASN22K10N		
		ASN40K11-T	ASN22K11N		
		ASN40K20-T	ASN22K20N		
		ASN40K22-T	ASN22K22N		
		ASN40K7S-T	ASN22K2RN-168		
	45° 3-position	ASN1K20□-T	ASN3K20N□		
		ASN1K40□-T	ASN3K40N□		
		ASN1K5S□-T	ASN3K22N□		
		ASN1K7S□-T	ASN3K02N□	(*1)	
		ASN1K8S□-T	ASN3K04N□	(*1)	
		ASN2K20□-T	ASN32K20N□		
		ASN2K40□-T	ASN32K40N□		
		ASN2K5S□-T	ASN32K22N□		
		ASN2K7S□-T	ASN32K02N□	(*1)	
		ASN2K8S□-T	ASN32K04N□	(*1)	
Selector Pushbuttons Ring Operator	90° 2-position	ASN20K20□-T	ASN31K20N□	(*1)	
		ASN20K40□-T	ASN31K40N□	(*1)	
		ASN20K5S□-T	ASN31K22N□	(*1)	
		ASN20K7S□-T	ASN31K02N□		
		ASN20K8S□-T	ASN31K04N□		
		ABN6111□	ASBN211N-A03□		
		ABN6411□	ASBN211N-K04□	(*2)	
		ABN9111□	N/A		
		ABN7120□	ASBN220N-D01□		
		ABN6122□	ASBN222N-A08□	(*1)	
	ABN6222□	ASBN222N-C10□	(*1)		
	ABN6422□	ASBN222N-K15□	(*2)		
	ABN7122□	ASBN222N-D10□	(*1)		
	ABN7222□	ASBN222N-E10□	(*1)		
	ABN7322□	ASBN222N-F10□	(*1)		
	ABN9122□	N/A			
	Selector Pushbuttons Lever Operator	ABN6L111□	ASBN211N-A03□	(*4)	
		ABN6L411□	ASBN211N-K04□	(*2)(*4)	
		ABN9L111□	N/A		
		ABN6L122□	ASBN222N-A08□	(*1)(*4)	
ABN6L222□		ASBN222N-C10□	(*1)(*4)		
ABN6L422□		ASBN222N-K15□	(*2)(*4)		
ABN7L122□		ASBN222N-D10□	(*1)(*4)		
ABN7L222□		ASBN222N-E10□	(*1)(*4)		
ABN7L322□		ASBN222N-F10□	(*1)(*4)		
ABN9L122□		N/A			
Pushbuttons	Pin Lock	ABN8P10	ABD8P10N□	(*5)	
		ABN8P01	ABD8P01N□	(*5)	
		ABN8P11	ABD8P11N□	(*5)	
		ABN8P20	ABD8P20N□	(*5)	
		ABN8P02	ABD8P02N□	(*5)	
		ABN8P22	ABD8P22N□	(*5)	
	ON Lock Type Pin Lock	ABN8P10-TK231-1	ABD8PN10N□	(*5)	
		ABN8P01-TK231-1	ABD8PN01N□	(*5)	
		ABN8P11-TK231-1	ABD8PN11N□	(*5)	
		ABN8P20-TK231-1	ABD8PN20N□	(*5)	
		ABN8P02-TK231-1	ABD8PN02N□	(*5)	
		ABN8P22-TK231-1	ABD8PN22N□	(*5)	
	Mushroom Pull	ATN2310□	AZN310N□		
		ATN2311□	AZN311N□		
		ATN2320□	AZN320N□		

- \*3) The knob operator is diecast zinc and in new shape. The knob operator can be installed at 45 degrees intervals.
- \*4) The new knob operator of selector pushbuttons is ring operator. The old series is lever operator.
- \*5) Button material      New series: plastic / Old series: metal