

ULTRA LG

Multistage Vertical

Stainless steel multistage vertical pumps. Pumping of clean non-loaded fluids, pressurizing system, irrigation, drinking and glycol water, water treatment, food industry, heating and air conditioning, washing system.

Construction features

Pump body	cast iron
Motor bracket	cast iron
Impellers, diffusers	Noryl®
Shell, motor shaft	stainless steel AISI 304
Mechanical seal	ceramic-graphite-EPDM graphite-silicon carbide-EPDM
Intermediate shaft guiding stage bush	ceramic-tungsten carbide
Ambient temperature	max 40 °C
Liquid temperature	+5 ÷ +35 °C
Max operating pressure	14 bar
Pump body gasket	EPDM

Motor

2 pole induction motor	3~ 400/690V - 50Hz P > 4kW
Insulation class	F
Protection degree	IPX5

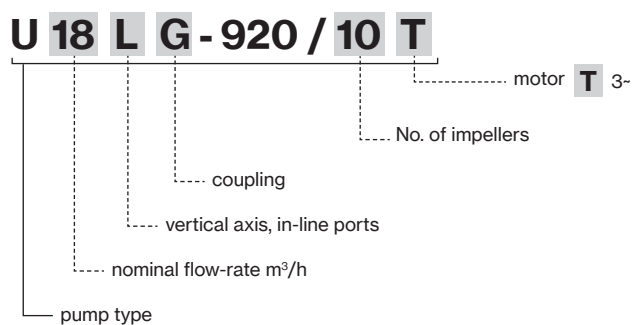

ULTRA V/L

TYPE	P2		P1 (kW)	A	Q (m ³ /h - l/min)											
					3~		0	6	7,2	9,6	12	14,4	16,8	19,2	21,6	24
					0	100	120	160	200	240	280	320	360	400		
3~	HP	kW	3~	3-400V 50 Hz	H (m)											
					U 18...-250/3T	2,5	1,85	2,2	4,2	34,7	32,9	32,6	31,6	30,1	28,0	24,7
U 18...-400/4T	4	3	3,0	5,8	47,1	45,4	45,2	44,3	42,6	40,0	36,0	30,6	24,6	17,8		
U 18...-450/5T	4,5	3,37	3,9	6,9	59,2	57,6	57,4	56,4	54,5	51,6	46,7	40,1	33,3	25,3		
U 18...-550/6T	5,5	4	4,6	8,4	71,4	69,7	69,6	68,2	65,7	62,2	56,3	48,0	39,4	29,4		
U 18...-750/8T	7,5	5,5	6,2	11,2	96,1	94,2	94,1	92,4	89,1	84,5	77,0	66,1	54,2	41,1		
U 18...-900/9T	10	7,5	6,9	12,8	108,5	106,9	107,0	105,3	101,7	96,8	88,6	75,9	62,6	47,8		

ULTRA LG

TYPE	P2		P1 (kW)	A	Q (m ³ /h - l/min)											
					3~		0	6	7,2	9,6	12	14,4	16,8	19,2	21,6	22,8
					0	100	120	160	200	240	280	320	360	380		
3~	HP	kW	3~	3-400V 50 Hz	H (m)											
					U 18LG-920/10T	10	7,5	7,7	14,0	120,4	116,8	118,3	116,6	112,6	104,4	96,3
U 18LG-1000/11T	10	7,5	8,3	13,6	132,4	128,9	130,0	128,0	123,0	115,0	103,9	93,0	72,6	63,4		

ULTRA V/L

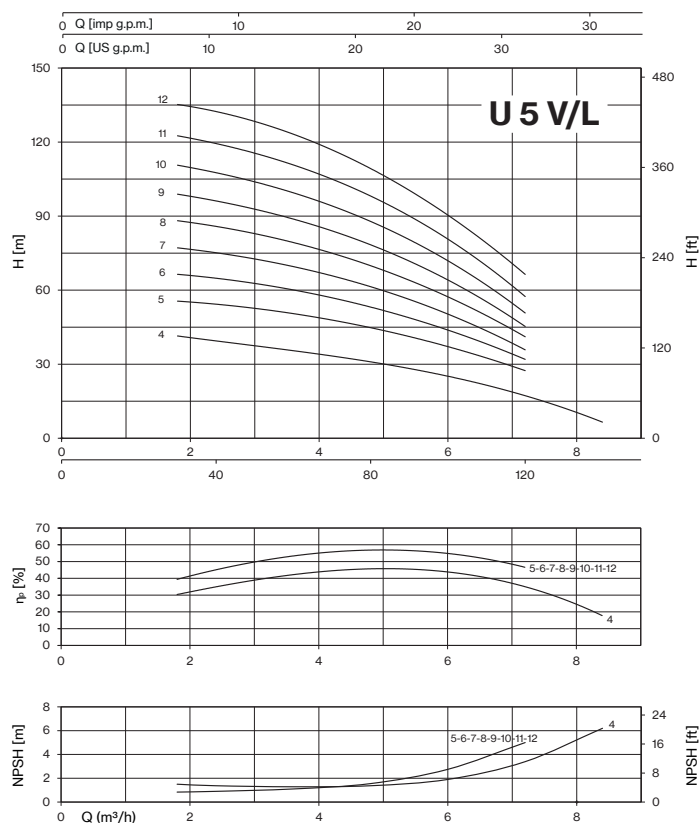
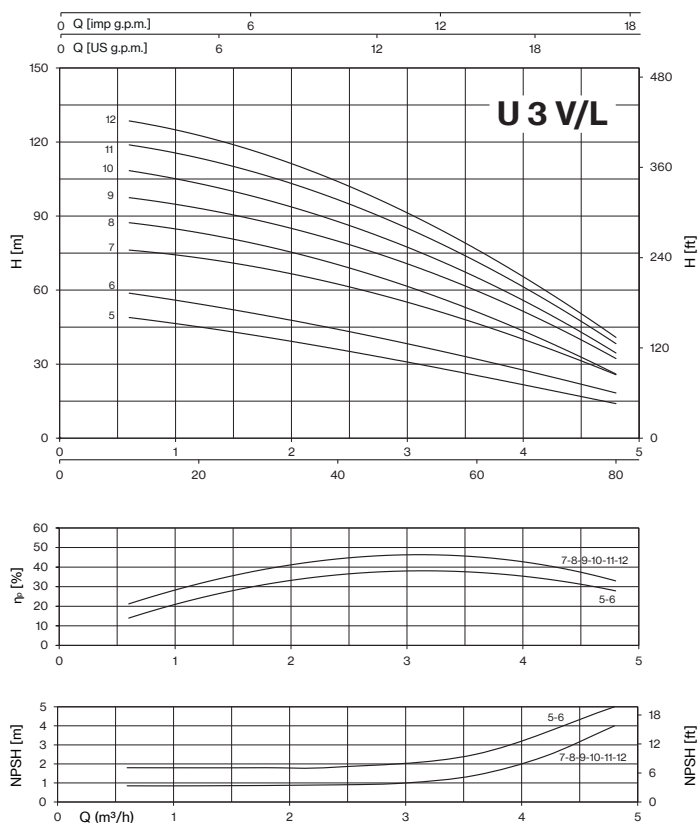

ULTRA V/L-LG

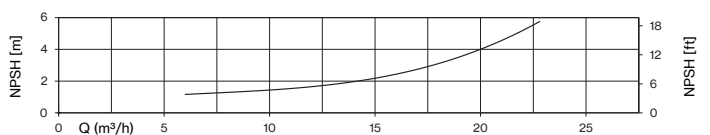
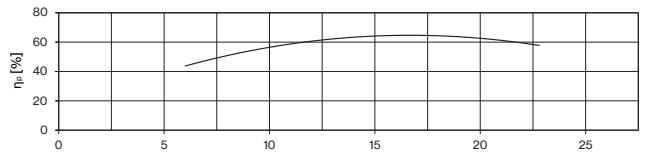
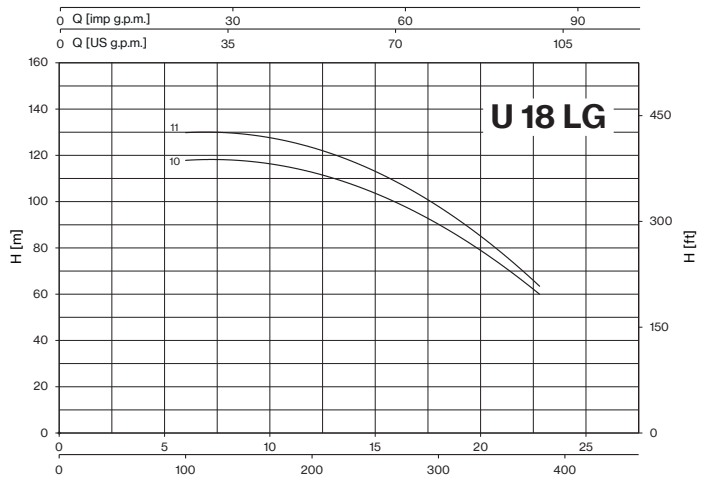
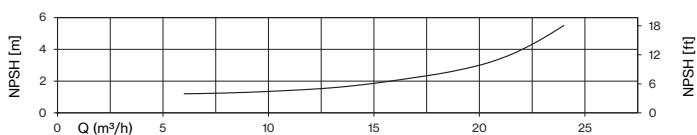
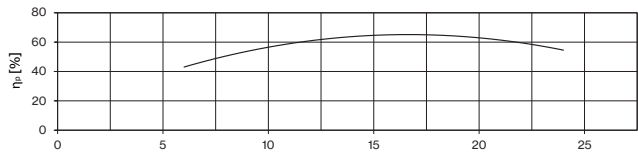
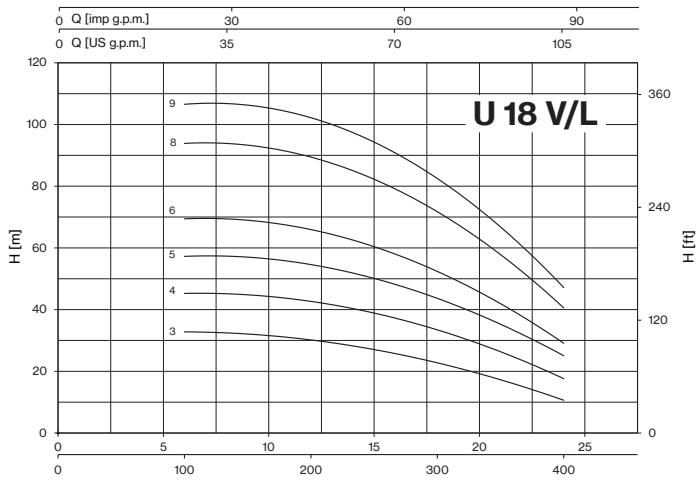
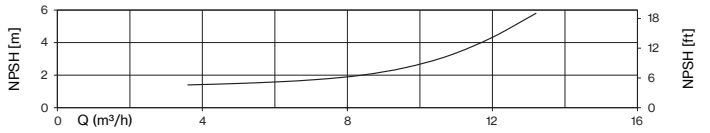
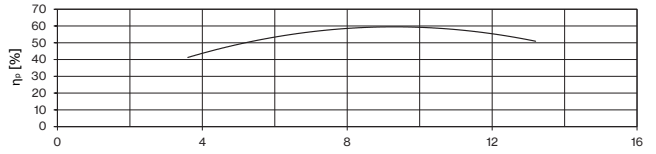
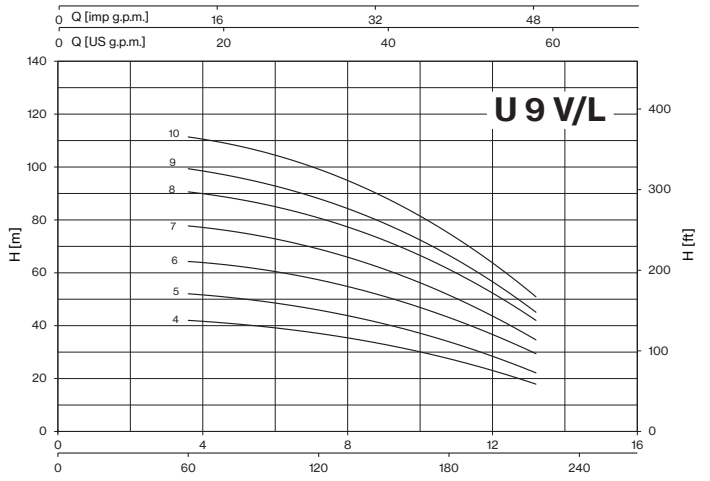
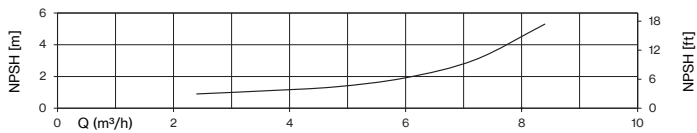
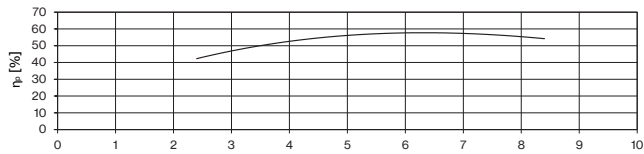
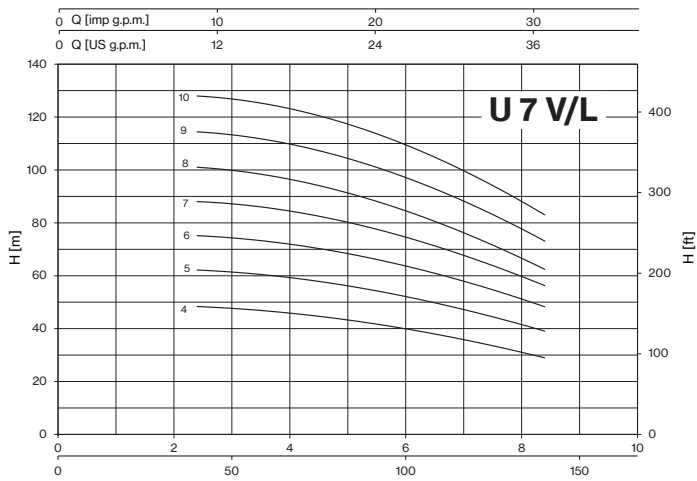

ULTRA LG

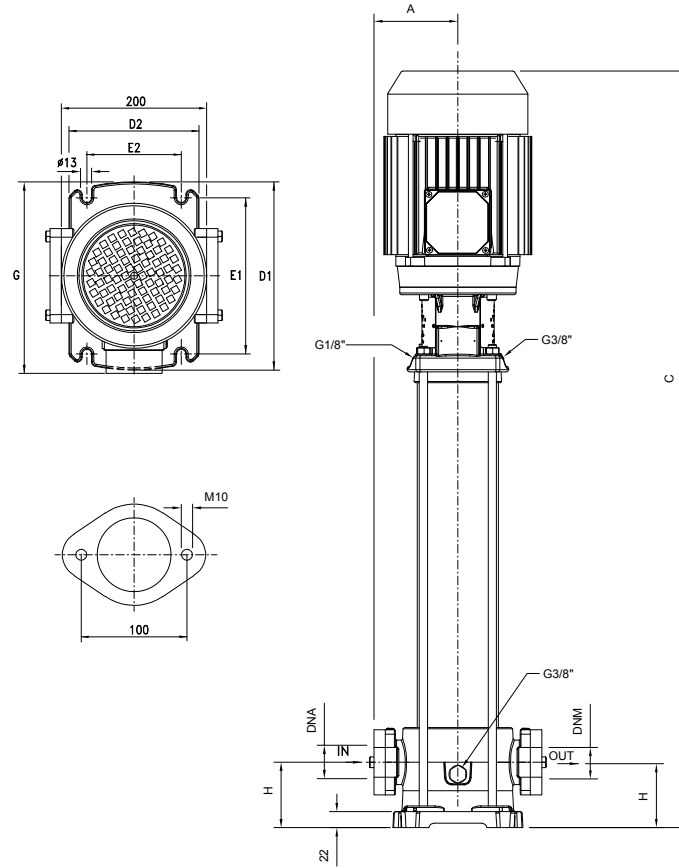



TYPE	DIMENSIONS (mm)										Kg	
	A	C	D1	D2	E1	E2	G	H	DNA	DNM		
-3												
U 18LG-920/10T	118	1019	260	180	215	130	307	90				68
U 18LG-1000/11T	118	1057	260	180	215	130	307	90	2" G	2" G		76

MODEL	LOTS			
	TRUCK		CONTAINER	
	PALLET (cm)	N° pumps	PALLET (cm)	N° pumps
U 18LG-920/10T - 1000/11T	100×120×150	12	100×120×150	12



ULTRA V-SV-L-SL-LG-SLG Serie-Mechanical seal and bearings

MECHANICAL SEAL	PUMP MODEL	SHAFT Ø		STANDARD MATERIAL	OPTIONAL
					2
	U3-100/5, U3-120/6, U5-120/4, U5-150/5, U5-180/6, U7-180/4, U7-250/5, U7-300/6, U9-200/4, U9-250/5, U18-250/3, U18-400/4	14mm / S	Rotating face Stationary face Elastomer	Graphite Ceramic EPDM	SiC SiC EPDM
	U3-150/7, U3-180/8, U3-200/9, U3-250/10, U3-280/11, U3-300/12, U5-200/7, U5-250/8, U5-280/9, U5-300/10, U5-350/11, U5-380/12, U7-350/7, U7-400/8, U7-450/9, U7-550/10, U9-300/6, U9-400/7, U9-450/8, U9-500/9, U9-550/10	14mm	Rotating face Stationary face Elastomer	Graphite SiC EPDM	SiC SiC EPDM
	U18-450/5, U18-550/6, U18-750/8, U18-900/9, U18-920/10, U18-1000/11	14mm / L	Rotating face Stationary face Elastomer	Graphite SiC EPDM	SiC SiC EPDM
	U3-350/14, U3-380/16, U3-400/18, U3-450/20, U5-400/14, U5-450/16, U5-550/18, U5-600/20, U7-750/12, U7-800/14, U7-900/16, U7-950/18, U7-1000/20, U9-750/12, U9-800/14, U9-900/16, U9-950/18, U9-1000/20	14mm / Balanced seal	Rotating face Stationary face Elastomer	Tungsten carbide Graphite EPDM	- - -

BEARINGS	PUMP MODEL	TYPE	
	U3-100/5, U3-120/6, U5-120/4	6202-ZZ	6302-ZZ C3
	U3-150/7, U3-180/8, U3-200/9, U3-250/10, 3- U3-280/11, 3- U3-300/12, U5-150/5, U5-180/6, U5-200/7, U5-250/8, 3- U5-280/9, 3- U5-300/10, U7-180/4, U7-250/5, 3- U7-300/6, U9-200/4, U9-250/5, 3- U9-300/6, U18-250/3	6203-ZZ	6304-ZZ C3
	1- U3-280/11, 1- U3-300/12, 1- U5-280/9, 1- U5-300/10, U5-350/11, U5-380/12, 1- U7-300/6, U7-350/7, U7-400/8, 1- U9-300/6, U9-400/7, U18-400/4, U3-350/14, U3-380/16, U3-400/18, U5-400/14	6203-ZZ	6305-ZZ C3
	U7-450/9, U7-550/10, U9-450/8, U9-500/9, U9-550/10, U18-450/5, U18-550/6	6204-ZZ	6306-ZZ-C3
	U3-450/20, U5-450/16, U5-550/18, U5-600/20	6204-ZZ	3206-ZZ C3
	U7-750/12, U7-800/14, U7-900/16, U9-750/12, U9-800/14, U9-900/16, U18-750/8, U18-900/9, U18-920/10	6206-ZZ C3	3306-ZZ C3
	U7-950/18, U7-1000/20, U9-950/18, U9-1000/20, U18-1000/11	6206-ZZ C3	3308-ZZ C3

