

# ULTRA SA

Self-priming



Self-priming horizontal multistage stainless steel pumps suitable for domestic use, also in combination with autoclave tank. Suitable for drinking water or glycol, for water treatment, heating, air conditioning and washing systems.

## Construction features

|   |                          |
|---|--------------------------|
| <b>Pump body, mechanical seal housing</b> | stainless steel AISI 304 |
| <b>Motor bracket</b>                      | aluminum                 |
| <b>Impellers, diffusers</b>               | stainless steel AISI 304 |
| <b>Mechanical seal</b>                    | ceramic-graphite-EPDM    |
| <b>Motor shaft</b>                        | stainless steel AISI 303 |
| <b>Liquid temperature</b>                 | -15 ÷ +110 °C            |
| <b>Operating pressure</b>                 | max 7 bar                |

## Motor

|                                |   |
|--------------------------------|---|
|                                | 3~ 230/400V - 50Hz  |
| <b>2 poles induction motor</b> | 1~ 230V - 50Hz<br>(with thermal protection up to 1.85 kW) |
| <b>Insulation class</b>        | F   |
| <b>Protection degree</b>       | IPX4  |

## U 3 S A - 100 / 5 T

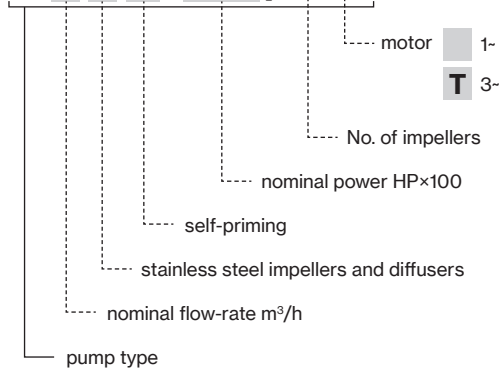

| TYPE        | TRUCK       |          | CONTAINER   |          |
|-------------|-------------|----------|-------------|----------|
|             | PALLET (cm) | N° pumps | PALLET (cm) | N° pumps |
| U 3SA-90/4  | 85×110×160  | 70       | 85×110×185  | 80       |
| U 3SA-100/5 | 80×120×150  | 42       | 80×120×175  | 49       |
| U 5SA-120/4 | 80×120×150  | 42       | 80×120×175  | 49       |
| U 5SA-150/5 | 80×120×150  | 42       | 80×120×175  | 49       |

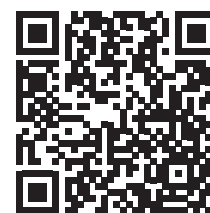

# ULTRA SA

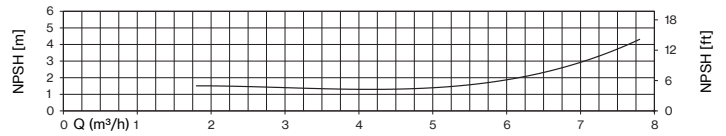
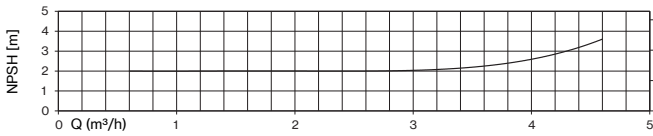
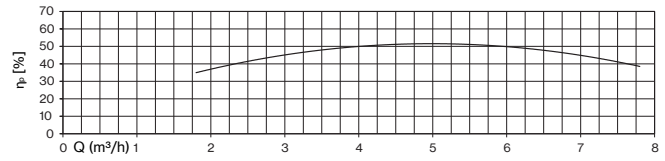
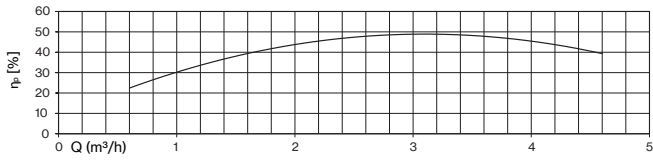
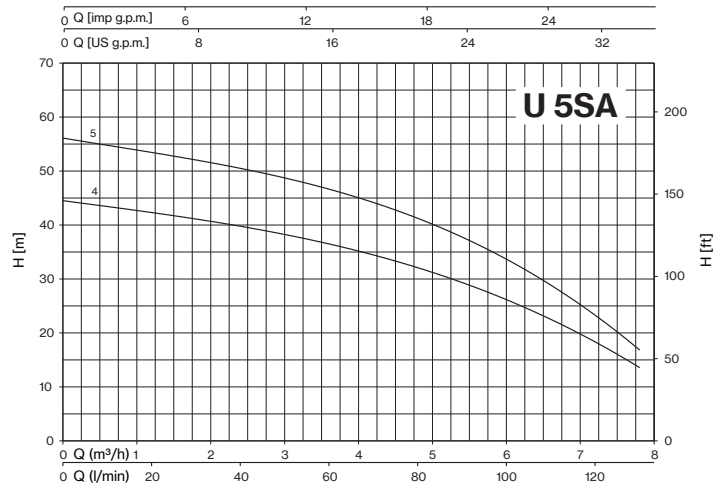
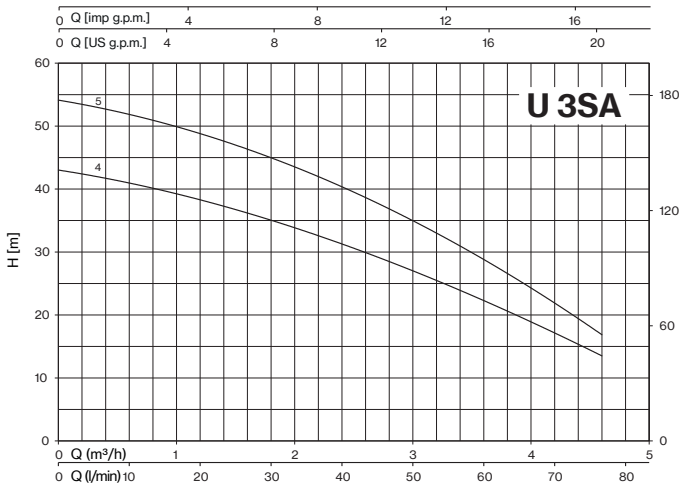

| TYPE        |              | P2  |      | P1 (kW) |      | AMPERE           |                  | Q (m³/h - l/min) |      |      |      |      |      |      |      |      |       |      |  |
|-------------|--------------|-----|------|---------|------|------------------|------------------|------------------|------|------|------|------|------|------|------|------|-------|------|--|
| 1~          | 3~           | HP  | kW   | 1~      | 3~   | 1~ 230V<br>50 Hz | 3~ 400V<br>50 Hz | 0                | 0,6  | 1,2  | 1,8  | 2,4  | 3,6  | 4,6  | 4,8  | 6    | 7     | 7,8  |  |
|             |              |     |      |         |      |                  |                  | 0                | 10   | 20   | 30   | 40   | 60   | 76,7 | 80   | 100  | 116,7 | 130  |  |
|             |              |     |      |         |      |                  |                  | H (m)            |      |      |      |      |      |      |      |      |       |      |  |
| U 3SA-90/4  | U 3SA-90/4T  | 0,9 | 0,66 | 0,83    | 0,8  | 3,6              | 1,7              | 43,0             | 41,0 | 38,3 | 35,0 | 31,3 | 22,3 | 13,5 |      |      |       |      |  |
| U 3SA-100/5 | U 3SA-100/5T | 1   | 0,75 | 0,99    | 0,92 | 4,4              | 1,7              | 54,0             | 52,1 | 48,8 | 44,9 | 40,2 | 29,0 | 16,8 |      |      |       |      |  |
| U 5SA-120/4 | U 5SA-120/4T | 1,2 | 0,9  | 1,09    | 1,08 | 4,9              | 2,4              | 44,5             |      |      | 41,0 | 40,0 | 36,4 | 32,8 | 32,0 | 26,2 | 18,5  | 13,5 |  |
| U 5SA-150/5 | U 5SA-150/5T | 1,5 | 1,1  | 1,39    | 1,31 | 6,5              | 2,7              | 56,0             |      |      | 52,4 | 50,5 | 46,4 | 42,0 | 41,0 | 33,8 | 23,8  | 16,5 |  |

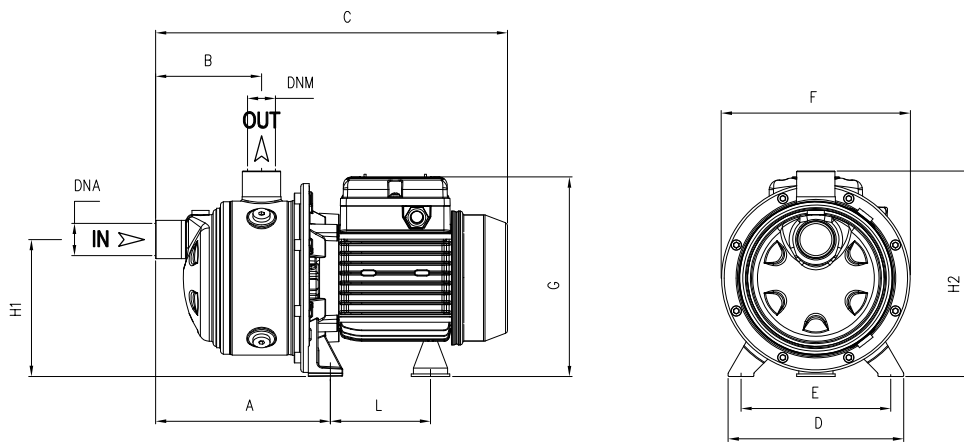

| TYPE        | DIMENSIONS (mm) |     |     |     |     |     |     |       |     |     |      |      | Kg   |
|-------------|-----------------|-----|-----|-----|-----|-----|-----|-------|-----|-----|------|------|------|
|             | A               | B   | C   | D   | E   | F   | G   | L     | H1  | H2  | DNA  | DNM  |      |
| U 3SA-90/4  | 238,8           | 175 | 405 | 164 | 140 | 178 | 190 | 93,7  | 128 | 192 |      |      | 10   |
| U 3SA-100/5 | 262,8           | 199 | 452 | 164 | 140 | 178 | 203 | 104,7 | 128 | 192 |      |      | 12,5 |
| U 5SA-120/4 | 238,8           | 175 | 428 | 164 | 140 | 178 | 203 | 104,7 | 128 | 192 | 1" G | 1" G | 12,5 |
| U 5SA-150/5 | 262,8           | 199 | 514 | 164 | 140 | 201 | 211 | 128,2 | 134 | 198 |      |      | 15,5 |

