

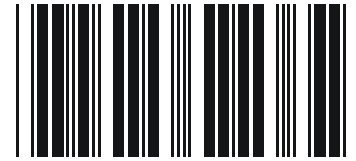

5011604303  
20030522



LE03

# User Manual

# VFD-L

VARIABLE SPEED AC MOTOR DRIVE

115V/230V 25W – 100W

HIGH PERFORMANCE / EASY CONTROL AC DRIVE



**ASIA**  
**DELTA ELECTRONICS, INC.**  
**TAOYUAN Plant/**  
31-1, SHIEN PAN ROAD,  
KUEI SAN INDUSTRIAL ZONE  
TAOYUAN 333, TAIWAN  
TEL: 886-3-362-6301  
FAX: 886-3-362-7267  
<http://www.deltaww.com/acdrives>

**NORTH/SOUTH AMERICA**  
**DELTA PRODUCTS**  
**CORPORATION**  
**Sales Office/**  
P.O. BOX 12173  
5101 DAVIS DRIVE  
RTP, NC 27709 U. S. A.  
TEL: 1-919-767-3813  
FAX: 1-919-767-3969  
<http://www.deltaww.com/acdrives>

**EUROPE**  
**DELTRONICS (Netherlands) B.V.**  
**Sales Office/**  
Industriegebied Venlo Nr. 9031  
Columbusweg 20  
NL-5928 LC Venlo  
The Netherlands  
TEL: 31-77-324-1930  
FAX: 31-77-324-1931

## Preface

Thank you for choosing Delta's high-performance VFD-L Series. VFD-L Series are manufactured by adopting high-quality components, material and incorporating the latest microprocessor technology available.

This manual will be helpful in the installation, parameter setting, troubleshooting, and daily maintenance of the AC motor drives. To guarantee safe operation of the equipment, read the following safety guidelines before connecting power to the AC motor drives. Keep this operating manual handy and distribute to all users for reference.

## Receiving and Inspection

This VFD-L AC drive has gone through rigorous quality control tests at the factory before shipment. After receiving the AC motor drive, please check for the following:

### Receiving

- ✓ Check to make sure that the package includes an AC drive and the User Manual.
- ✓ Inspect the unit to insure it was not damaged during shipment.
- ✓ Make sure that the part number indicated on the nameplate corresponds with the part number of your order.

### Nameplate Information: Example of 100W 230V AC drive

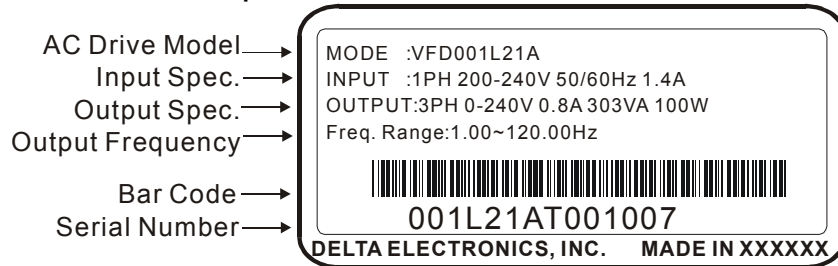

### Model Explanation and Series Number Explanation:

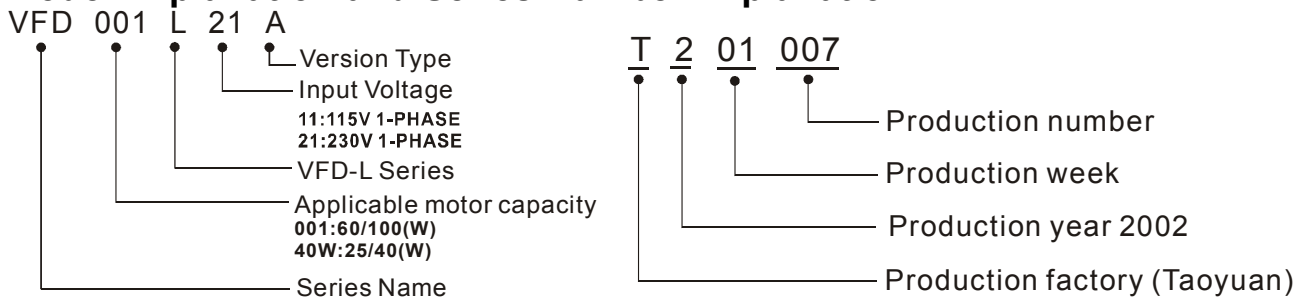

If there is any nameplate information not corresponding to your purchase order or any problem, please contact your supplier.

**⚠ DANGER!** AC input power must be disconnected before any maintenance. Do not connect or disconnect wires and connectors while power is applied to the circuit.

**⚠ CAUTION!** There are highly sensitive MOS components on the printed circuit boards. These components are especially sensitive to static electricity. Do not touch these components or the circuit boards with metal objects or your bare hands.

**⚠ CAUTION!** Ground the VFD-L using the ground terminal. The grounding method must comply with the laws of the country where the AC drive is to be installed.

**⚠ CAUTION!** Heat sink may heat up over 70°C (158°F), during the operation. Do not touch the heat sink.

## 2

### Storage and Installations

#### Storage:

The AC drive should be kept in the shipping carton before installation. In order to retain the warranty coverage, the AC drive should be stored properly when it is not to be used for an extended period of time.

#### Ambient Conditions:

|                       |                             |  |
|-----------------------|-----------------------------|--|
| <b>Operation</b>      | Air Temperature:            | -10° C to +40° C (14° F to 122° F)   |
|                       | Atmosphere pressure:        | 86 to 106 kPa  |
|                       | Installation Site Altitude: | below 1000m  |
|                       | Vibration:                  | Maximum 9.86 m/s <sup>2</sup> (1G) at less than 20Hz<br>Maximum 5.88 m/s <sup>2</sup> (1G) at 20Hz to 50Hz |
| <b>Storage</b>        | Temperature:                | -20° C to + 60° C (-4° F to 140° F)  |
|                       | Relative Humidity:          | Less than 90%, no condensation allowed   |
|                       | Atmosphere pressure:        | 86 to 106 kPa  |
|                       | Temperature:                | -20° C to +60° C (-4° F to 140° F)   |
| <b>Transportation</b> | Relative Humidity:          | Less than 90%, no condensation allowed   |
|                       | Atmosphere pressure:        | 86 to 106 kPa  |
|                       | Vibration:                  | Maximum 9.86 m/s <sup>2</sup> (1G) at less than 20Hz<br>Maximum 5.88 m/s <sup>2</sup> (1G) at 20Hz to 50Hz |

#### Installations and Connection:



The control, power supply and motor leads must be laid separately. They must not be fed through the same cable conduit / trucking.  
High voltage insulation test equipment must not be used on cables connected to the drive.  
Wait five minutes for DC bus capacitors discharge.

***Any Electrical or mechanical modification to this equipment without prior written consent of Delta Electronics, Inc. will void all warranties and may result in a safety hazard in addition to voiding the UL listing.***

#### Short Circuit Withstand:

Suitable for use on a circuit capable of delivering not more than 5,000 rms symmetrical amperes, for 230V Models, the maximum is 240 Volts.

Improper installation of the AC drive will greatly reduce its life. Be sure to observe the following precautions when selecting a mounting location. **Failure to observe these precautions may void the warranty!**

- ◆ Do not mount the AC drive near heat-radiating elements or in direct sunlight.
- ◆ Do not install the AC drive in a place subjected to high temperature, high humidity, excessive vibration, corrosive gases or liquids, or airborne dust or metallic particles.
- ◆ Mount the AC drive vertically and do not restrict the airflow to the heat sink fins.
- ◆ The AC drive generates heat. Allow sufficient space around the unit for heat dissipation as shown in the figure shown next page:

3

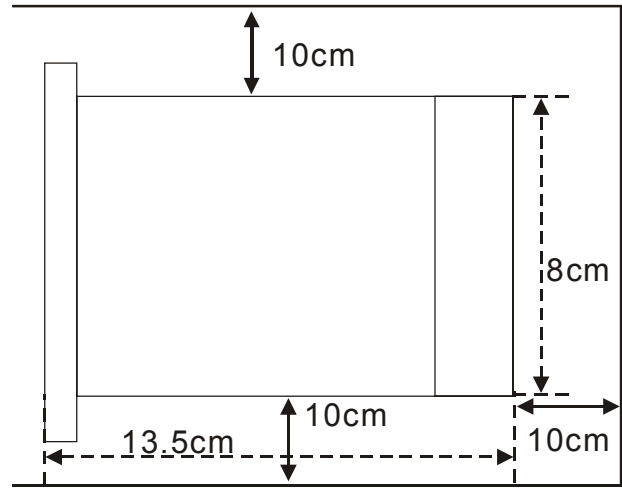
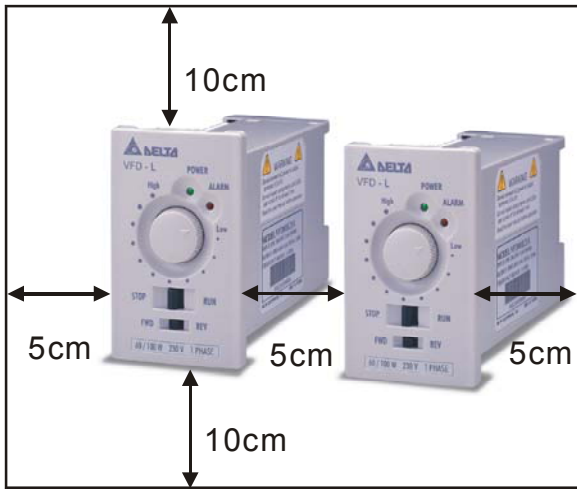

**Connections:**

Installations intended to meet UL and CUL requirements must follow the instructions provided in “Wiring Notes” section below as a minimum standard. Where local codes exceed these requirements, they must also be followed. Refer to the technical data label affixed to the AC drive and the motor nameplate for electrical data.

**Basic Wiring Diagram**

Users must connect wiring according to the following circuit diagram shown below.

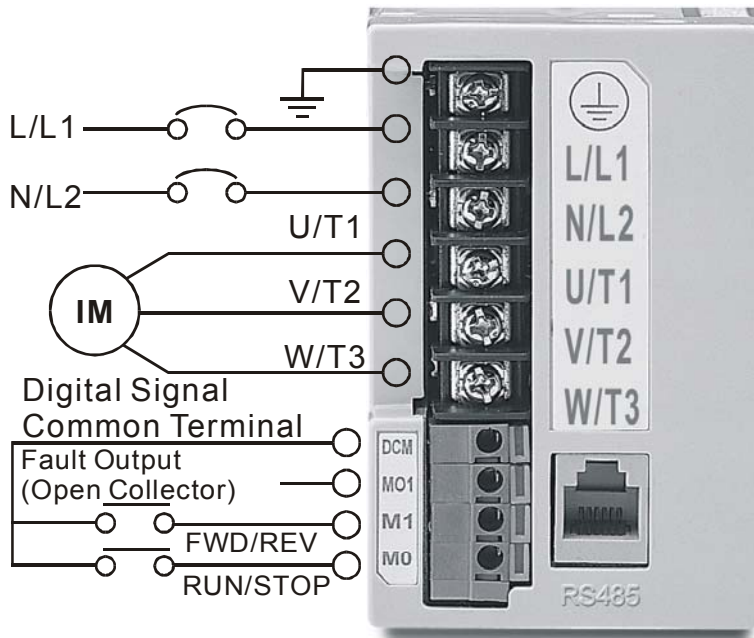

Wire Gauge: 22-14 AWG  
Torque: 10kgf-cm  
(8.7 in-lbf)

**RS-485 Serial Interface**  
1 : +EV  
2 : GND  
3 : SG-  
4 : SG+  
PIN 1 & 2 are the power source for the digital keypad and should not be used while using RS-485 communication.

**\*NOTE\*:** Do not plug a Modem or telephone line to the RS-485 communication port, permanent damage may result. Terminals 2 & 5 are the power sources for the optional copy keypad and should not be used while using RS-485 communication.

# 4

## Main Circuit Terminals: wire gauge 22-14AWG, torque 10kgf-cm (8.7 in-lbf)

| Terminal Symbols | Terminal Functions      |
|------------------|-------------------------|
| L/L1, N/L2       | AC line input terminals |
| U/T1, V/T2, W/T3 | Motor connections       |
| ⊕                | Earth Ground            |

## Control Circuit Wiring: wire gauge 22-14AWG, torque 10kgf-cm (8.7 in-lbf)

| Terminal symbols | Terminal names            | Remarks  |
|------------------|---------------------------|--|
| M0               | RUN/STOP                  | Normally Open contact, AC drive starts operation when closes.      |
| M1               | FWD/REV                   | Normally Open contact, AC drive starts reverse motion when closes. |
| MO1              | Fault Indication          | When error is detected, MO1 will close.                            |
| RS-485           | Serial Communication Port | When DIP Switch 7 is ON, the drive is controlled by RS-485.        |
| DCM              | Digital Signal Common     | Ground for M0, M1 and M01  |

### ◆ Front Panel Control Diagram

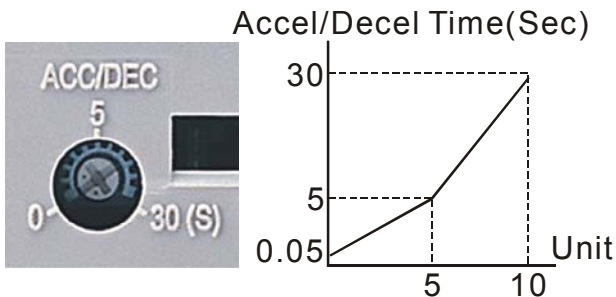
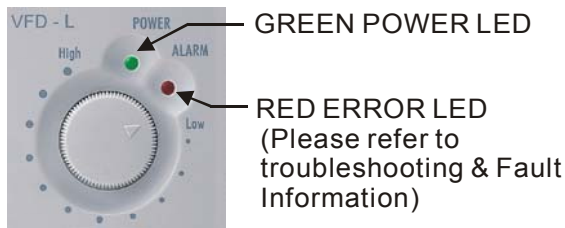

Accel/Decel Time Knob (sec.)

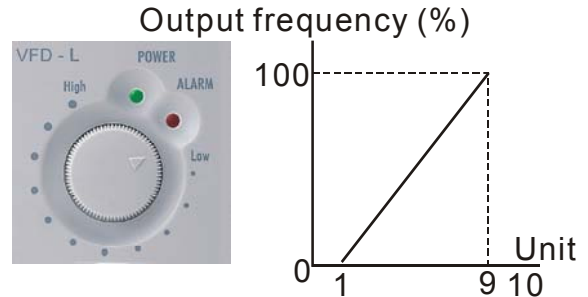





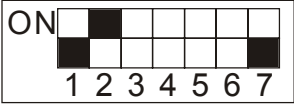
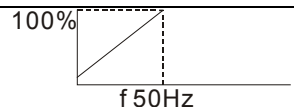
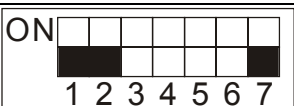
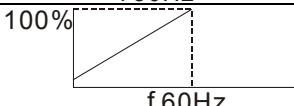

Output Frequency Knob (Hz)

### Switch Setting Descriptions:

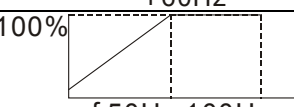
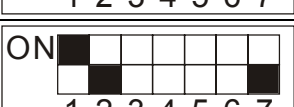
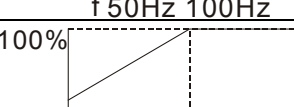
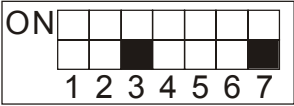
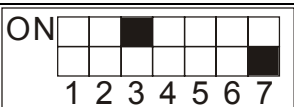
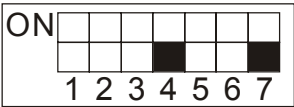
The DIP Switches can only be changed when AC drive is in a stopped mode.

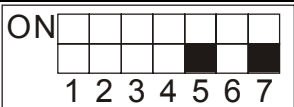
■ Indicates the position of the switch (ON/OFF).

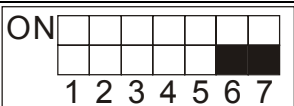
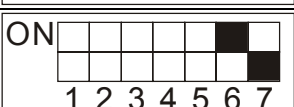
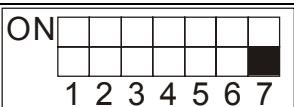
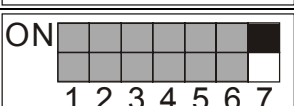
| DIP Switch | Switch Name                         | Switch Setting  | Parameter Descriptions   |   |
|------------|-------------------------------------|---|--|---|
| 1          | Max. Output Frequency               | ON <br>1 2 3 4 5 6 7   | Maximum Output Frequency   | V/F Curve   |
|            |                                     |   | 50Hz   |  |
|            |                                     | ON <br>1 2 3 4 5 6 7   | 60Hz   |  |
|            |                                     | ON <br>1 2 3 4 5 6 7   | 100Hz  |  |
| 2          |                                     | ON <br>1 2 3 4 5 6 7   | 120Hz  |  |
| 3          | Reverse Inhibit                     | ON <br>1 2 3 4 5 6 7   | Reverse enable   |   |
|            |                                     | ON <br>1 2 3 4 5 6 7  | Reverse disable  |   |
| 4          | Torque Setting                      | ON <br>1 2 3 4 5 6 7 | Low torque output  |   |
|            |                                     | ON <br>1 2 3 4 5 6 7 | High torque output   |   |
| 5          | Electronic Thermal Setting          | ON <br>1 2 3 4 5 6 7 | Applicable for 40/100W motor   |   |
|            |                                     | ON <br>1 2 3 4 5 6 7 | Applicable for 25/60W motor  |   |
| 6          | Operation Command Source Select (1) | ON <br>1 2 3 4 5 6 7 | Operation command controlled by potentiometer.   |   |
|            |                                     | ON <br>1 2 3 4 5 6 7 | Operation command controlled by external terminal  |   |
| 7          | Operation Command Source Select (2) | ON <br>1 2 3 4 5 6 7 | Operation command controlled by external terminal (can be monitored by communication mode)         |   |
|            |                                     | ON <br>1 2 3 4 5 6 7 | Switch 7 is ON, indicates the communication mode is enabled; switches 1 to 6 are address settings. |   |

## 6

### Communication

There is three control modes: RS-485 communication, AC drive front panel, and external terminals. Only one mode can be used at a time and is selected by DIP Switch 6 and 7. Programming can only be done **when the AC drive is in stopped mode**.

DIP switch settings for control

- ◆ DIP Switch 6 determines if control is via the AC drives front panel or external terminals. Set DIP switch 6 to OFF for AC drive front panel control and ON for external terminal control
- ◆ DIP Switch 7 determines if control is local or via RS-485 communication. When DIP Switch 7 is OFF, the AC drive front panel or external terminals control the drive.

Note: The parameters set via RS-485 communication will remain in memory. Users can still read the status of the AC drive via RS-485 communication, but cannot send any control commands.

When DIP Switch 7 is ON, the drive is controlled by RS-485 communication. Please verify the AC drive is fully stopped prior to turn DIP Switch 7 ON. If DIP Switch 7 is turned ON during operation, the error LED will illuminate.

### Computer Controls

Each VFD-L AC Drive has a pre-assigned communication address specified by DIP Switch pins 1 to 6 (Refer to the description of setting up address). VFD-L type Communication agreement: Modbus ASCII mode, protocol <7, N, 2>, Baud rate 9600. The computer then controls each AC Drive according to its communication address.

- ◆ ASCII Modes:

Each 8-bit data is the combination of two ASCII characters. For example, a 1-byte data: 64 Hex, shown as '64' in ASCII, consists of '6' (36Hex) and '4' (34Hex).

|            |     |     |     |     |     |     |     |     |
|------------|-----|-----|-----|-----|-----|-----|-----|-----|
| Character  | '0' | '1' | '2' | '3' | '4' | '5' | '6' | '7' |
| ASCII code | 30H | 31H | 32H | 33H | 34H | 35H | 36H | 37H |
| Character  | '8' | '9' | 'A' | 'B' | 'C' | 'D' | 'E' | 'F' |
| ASCII code | 38H | 39H | 41H | 42H | 43H | 44H | 45H | 46H |

- ◆ Data Format

10-bit character frame (For 7-bit character): ❖ (7, N, 2)

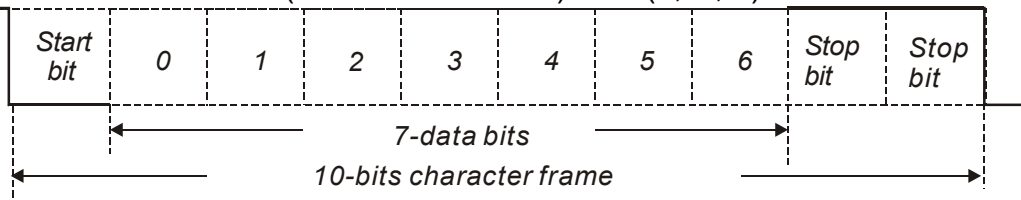

### AC Drive Addresses for RS-485 Communication

VFD-L series communication addresses are 1 to 63, since 0 means broadcast to all AC drives. A DIP Switch sets to ON for equal to 1 and OFF for equal to 0.

If DIP Switch 7 is OFF during power up, the communication address for the drive is 0008H, this is address 1 (factory default).

If DIP Switch 7 is ON during power up, the address settings are determined by the ON/OFF positions of DIP Switches 1 to 6. Address 1 is when all switches are set to the OFF position. Switch "1" is the upper bit and switch 6 is the lower bit.

(A) The addresses will remain in memory when the control mode changes to AC drive panel or external terminals.



# 7

(B) The addresses will remain in memory when parameters are reset.

To save new addresses, remove power from the drive, set DIP switch 7 to ON and reapply power to the drive, at this time the new addresses will be read.

Examples of setting up the address (Black block means ON or OFF of DIP SWITCH):

|                        |                             |                             |                             |                             |
|------------------------|-----------------------------|-----------------------------|-----------------------------|-----------------------------|
| ON                     | ON                          | ON                          | ON                          | ON                          |
| 1                      | 1                           | 1                           | 1                           | 1                           |
| 2                      | 2                           | 2                           | 2                           | 2                           |
| 3                      | 3                           | 3                           | 3                           | 3                           |
| 4                      | 4                           | 4                           | 4                           | 4                           |
| 5                      | 5                           | 5                           | 5                           | 5                           |
| 6                      | 6                           | 6                           | 6                           | 6                           |
| 7                      | 7                           | 7                           | 7                           | 7                           |
| Communication Inhibits | Communication address is 01 | Communication Address is 01 | Communication Address is 02 | Communication Address is 63 |

## Communication Protocol

Communication Data Frame:

|            |   |
|------------|---|
| STX        | Start character ':' (3AH)   |
| ADR 1      | Communication address: 8-bit address consists of 2 ASCII codes                                  |
| ADR 0      |   |
| CMD 1      | Command code: 8-bit command consists of 2 ASCII codes   |
| CMD 0      |   |
| DATA (n-1) | Contents of data:<br>n×8-bit data consist of 2n ASCII codes.<br>n≤25, maximum of 50 ASCII codes |
| To         |   |
| DATA 0     |   |
| LRC CHK 1  | LRC check sum: 8-bit check sum consists of 2 ASCII codes  |
| LRC CHK 0  |   |
| END 1      | End characters: END1 = CR (0DH), END0 = LF (0AH)  |
| END 0      |   |

### ◆ ADR (Communication Address)

Valid communication addresses are in the range of 1 to 63. Communication address equal to 0, means broadcast to all AC drives. In this case, the AMD will not reply any message to the master device.

### ◆ CMD (Command code) and DATA (data characters)

The format of data characters depends on the command code. The available command codes are described as followed:

|  |     |                   |     |  |     |                   |     |
|--|-----|-------------------|-----|--|-----|-------------------|-----|
| Command code: 03H, read N words. The maximum value of N is 12. For example, reading continuous 2 words from starting address 2102H of AMD with address 01H |     |                   |     | Command code: 06H, write 1 word<br>For example, writing 6000 (1770H) to address 2001H of AMD with address 01H. |     |                   |     |
| Command message:   |     | Response message: |     | Command message:   |     | Response message: |     |
| STX  | :   | STX               | :   | STX  | :   | STX               | :   |
| ADR 1  | '0' | ADR 1             | '0' | ADR 1  | '0' | ADR 1             | '0' |
| ADR 0  | '1' | ADR 0             | '1' | ADR 0  | '1' | ADR 0             | '1' |
| CMD 1  | '0' | CMD 1             | '0' | CMD 1  | '0' | CMD 1             | '0' |
| CMD 0  | '3' | CMD 0             | '3' | CMD 0  | '6' | CMD 0             | '6' |



|                                |     |  |     |                |     |                |     |     |
|--------------------------------|-----|--|-----|----------------|-----|----------------|-----|-----|
| Starting data address          | '2' | Number of data (byte)                  | '0' | Data address   | '2' | Data address   | '2' |     |
|                                | '1' |  | '4' |                | '0' |                | '0' |     |
|                                | '0' | Content of starting data address 2102H | '1' |                | '0' |                | '0' | '0' |
|                                | '2' |  | '7' |                | '7' |                | '1' | '1' |
| Number of data (Count by word) | '0' | Content of data address 2103H          | '0' | Data content   | '1' | Data content   | '1' |     |
|                                | '0' |  | '0' |                | '7' |                | '7' |     |
|                                | '0' |  | '0' |                | '7' |                | '7' |     |
|                                | '2' |  | '0' |                | '0' |                | '0' |     |
| LRC CHK 1                      | 'D' | LRC CHK 1                              | '7' | LRC CHK 1      | '5' | LRC CHK 1      | '5' |     |
| LRC CHK 0                      | '7' | LRC CHK 0                              | '1' | LRC CHK 0      | '1' | LRC CHK 0      | '1' |     |
| END 1<br>END 0                 | CR  | END 1<br>END 0                         | CR  | END 1<br>END 0 | CR  | END 1<br>END 0 | CR  |     |
|                                | LF  |  | LF  |                | LF  |                | LF  |     |

◆ CHK (check sum)

LRC (Longitudinal Redundancy Check) is calculated by summing up the values of the bytes from ADR1 to last data character then calculating the hexadecimal representation of the 2's-complement negation of the sum. For example, using the command message of above:

|                       |     |
|-----------------------|-----|
| STX                   | ':' |
| ADR 1                 | '0' |
| ADR 2                 | '1' |
| CMD 1                 | '0' |
| CMD 2                 | '3' |
| STARTING DATA ADDRESS | '2' |
|                       | '1' |
|                       | '0' |
|                       | '2' |
| NUMBER OF DATA        | '0' |
|                       | '0' |
|                       | '0' |
|                       | '2' |
| LRC CHK 1             | 'D' |
| LRC CHK 0             | '7' |
| END 1                 | CR  |
| END 0                 | LF  |

$01H+03H+21H+02H+00H+02H=29H$ , the 2's-complement negation of 29H is D7H.

Parameters (saved in the EEPROM) ★: the parameter can be set during the operation.

| Parameter | Parameter Function      | Parameter Setting                              | Factory Setting | Customer Setting |
|-----------|-------------------------|--|-----------------|------------------|
| 0         | Identity code of Drive  | Depend on drive                                |                 | Read only        |
| 1         | Rating current          | Depend on drive                                | 1               | Read/Write       |
| 2         | Parameter Reset         | 10: Reset                                      | 0               | Read/Write       |
| 3         | Max. Operation Freq.    | 0: 50 Hz<br>1: 60 Hz<br>2: 100 Hz<br>3: 120 Hz | 1               | Read Only        |
| ★4        | Accel/Decel Time        | 0.05 to 30.00 sec                              | 5.00            | Read/Write       |
| 5         | Reverse Inhibit         | 0: Reverse disable<br>1: Reverse enable        | 1               | Read/Write       |
| 6         | Torque Increase         | 0: High Torque<br>1: Low Torque                | 1               | Read/Write       |
| 7         | Electronic Thermal      | 0: 25/60 w<br>1: 40/100 w                      | 1               | Read/Write       |
| 8         | Communication Addresses | 01 to 63                                       | 1               | Read/Write       |
| 9         | Software Version        | Read only                                      | ##              | Read Only        |

#### Address List:

The contents of available addresses are shown as below:

| Content:            | Address: | Function:   |   |
|---------------------|----------|---|---|
| AC drive Parameters | nnnnH    | nnnn means parameter number, for example, the address of 0004 is 0004H. When reading parameter by command code 03H, only one parameter can be read at one time. |   |
| Command Write only  | 2000H    | Bit 0 to 1  | 00B: No function<br>01B: Stop<br>10B: Run<br>11B: No function     |
|                     |          | Bit 2 to 3  | Reserved  |
|                     |          | Bit 4 to 5  | 00B: No function<br>01B: FWD<br>10B: REV<br>11B: Change direction |
|                     |          | Bit 6 to 15   | Reversed  |
|                     | 2001H    | Frequency command   |   |
|                     | 2002H    | Bit 0   | 1: Reversed   |
| Bit 1               |          | 1: Reset  |   |
| Bit 2-15            |          | Reserved  |   |

| Content:                      | Address:                 | Function:  |                              |  |
|-------------------------------|--------------------------|--|------------------------------|--|
| Status monitor<br>(Read only) | 2100H                    | Error Codes<br>00: No error occurred<br>01: Over-current (oc)<br>02: Over-voltage (ov)<br>03: Overheat (oH)<br>04: Overload (oL)<br>05, 06: Reserved<br>07: CPU failure (cF3)<br>08 to 13: Reserved<br>14: Low voltage (Lv)<br>15: CPU failure 1 (cF1)<br>16: CPU failure 2 (cF2)<br>17 to 19: Reserved<br>20: Software protection<br>21: Operation error<br>22: OH Hardware failure cF3.1<br>23: OV Hardware failure cF3.2<br>24: LV Hardware failure cF3.3<br>26: Hardware failure cF3.5 (current detection)<br>30: Hardware failure hpf.2<br>31: Hardware failure hpf.3 |                              |  |
|                               |                          | 2101H  | Bit 0 to 1                   | 00: STOP<br>01: Ramp stop<br>10: Zero speed<br>11: Operation   |
|                               |                          |  | Bit 2                        | Reserved   |
|                               |                          |  | Bit 3 to 4                   | 00: Forward motion<br>01: from Reverse to Forward motion<br>10: from Forward to Reverse motion<br>11: Reverse motion |
|                               |                          |  | Bit 5 to 9                   | Reserved   |
|                               |                          |  | Bit 10                       | 1: Operation commands are controlled by communication interface.   |
|                               |                          |  | Bit 11 to 15                 | Reserved   |
|                               |                          | 2102H  | Frequency Command F (XXX.XX) |  |
|                               |                          | 2103H  | Output Frequency H (XXX.XX)  |  |
|                               |                          | 2104H  | Output Current A (X.XX)      |  |
|                               |                          | 2105H  | DC-BUS Voltage (XXX)         |  |
| 2106H                         | Output Voltage E (XXX.X) |  |                              |  |

### Exception Responses:

Except for broadcast messages, the AC drive is expected to return a normal response after receiving command messages from the master device. The following depicts the conditions that no normal response is replied to the master device.

The AC drive does not receive the messages due to a communication error; thus, the AC drive has no response. The master device will eventually process a timeout condition. The AC drive receives the messages without a communication error, but cannot handle it, an exception response will return to the master device. In the exception response, the most significant bit of the original command code is set to 1, and an exception code explains the condition that caused the exception is returned. An example of exception response of command code 06H and exception code 02H:

|                  |     |     |
|------------------|-----|-----|
| STX              | ‘.’ | 3AH |
| ADDRESS 1        | ‘0’ | 30H |
| ADDRESS 0        | ‘1’ | 31H |
| FUNCTION (CMD) 1 | ‘8’ | 38H |
| FUNCTION (CMD) 0 | ‘6’ | 36H |
| EXCEPTION CODE   | ‘0’ | 30H |
|                  | ‘2’ | 32H |
| LRC CHK 1        | ‘7’ | 43H |
| LRC CHK 0        | ‘7’ | 46H |
| END 1            | CR  | 0DH |
| END 0            | LF  | 0AH |

The explanation of exception codes:

| Exception codes: | Explanation  |
|------------------|--|
| 01               | Illegal command code:<br>The command code received in the command message is not available for the AC drive. |
| 02               | Illegal data address:<br>The data address received in the command message is not available for the AC drive. |
| 03               | Illegal data value:<br>The data value received in the command message is over range for the AC drive.        |
| 04               | Slave device failure:<br>The AC drive is unable to perform the requested action.                             |
| 09               | Check Sum Error: Check if the Check Sum is correct.  |
| 20               | Watchdog Timer: The timer will reset to 0 after each valid MODBUS communication message is received.         |

## Maintenance and Inspections

Modern AC drives are based on solid state electronics technology, preventive maintenance is required to operate this AC drive in its optimal condition, and to ensure a long life. It is recommended to perform a monthly check up of the AC drive by a qualified technician. Before the check up, always turn off the AC Input Power to the unit. Wait at least 2 minutes after all display lamps have gone out, and then confirm that the capacitors have fully discharged.

### Periodic Inspection:

Basic check up items to detect if there were any abnormality during the operation.

1. Whether the motors are operating as expected.
2. Whether the installation environment is abnormal.
3. Whether the cooling system is operating as expected.
4. Whether any irregular vibration or sound occurred during the operation.
5. Whether the motors are overheated during the operation.
6. Always check the input voltage of the AC drive with Voltmeter.

### Periodic Maintenance:

It is necessary to stop the motor operation during the check up.

1. Tighten and reinforce the screws of the AC drive if necessary, cause it may loose due to the vibration or changing of temperatures.
2. Whether the conductors or insulators were corroded and damaged.
3. Check the resistance of the insulation with Megaohmmeter.
4. Often check and change the capacitors and relays.
5. If use of the AC drive is discontinued for a long period of time, turn the power on at least once every two years and confirm that it still functions properly. To confirm functionality, disconnect the motor and energize the AC drive for 5 hours or more before attempting to run a motor with it.
6. Clean off any dust and dirt with a vacuum cleaner. Place special emphasis on cleaning the ventilation ports and PCBs. Always keep these areas clean, as adherence of dust and dirt can cause unforeseen failures.

### Fuse and Fuse Breaker (NFB) Specifications:

| Model     | Ampere Rating (A) | Manufacturer (Reference) |
|-----------|-------------------|--------------------------|
| 40W 115V  | 6.0A              | Busmann - JJN-6 300V     |
| 40W 230V  | 3.0A              | Busmann - JJN-3 300V     |
| 100W 115V | 10.0A             | Bssmann - JJN-10 300V    |
| 100W 230V | 6.0A              | Bssmann - JJN-6 300V     |

## Troubleshooting and Fault Information

The AC drive has a comprehensive fault diagnostic system that includes several different alarms and fault message. Once a fault is detected, the corresponding protective functions will be activated to shut down the AC drive output. Below are the fault descriptions, for a fault shown on the AC drive digital keypad. After fault has been cleared, switch the Run/Stop key to stop mode to reset the drive.

| Fault Display  | Fault Descriptions  | Corrective Actions  |
|--|---|---|
| Alarm LED lighten after power on                                 | Hardware failure  | Return to the factory   |
| Alarm LED flashes once in every two seconds                      | The AC drive detects an abnormal increase in current (Over-current)                   | <ol style="list-style-type: none"> <li>1. Increase the acceleration time</li> <li>2. Check whether the motor output power corresponds to the AC drive output power</li> <li>3. Check the wiring connection between the AC drive and motor for possible short circuit</li> <li>4. Check for possible over loading conditions at the motor</li> </ol> |
| Alarm LED flashes twice in every two seconds (Over-voltage)      | The AC drive detects that the DC-BUS voltage has exceeded its maximum allowable value | <ol style="list-style-type: none"> <li>1. Check whether the input voltage falls within the rated AC Drive input voltage.</li> <li>2. Check for possible voltage transients.</li> <li>3. Bus over-voltage may be caused by motor regeneration, increase the accel/decel time.</li> </ol>   |
| Alarm LED flash thrice in every two seconds (Overload)           | Motor overload  | <ol style="list-style-type: none"> <li>1. Check for possible motor overload.</li> <li>2. Adjust torque detection setting of the DIP SW4 to an appropriate setting.</li> <li>3. Increase the AC Drive's output capacity.</li> </ol>  |
| Alarm LED flashes four times in every two seconds (Over-heating) | The AC drive temperature sensor detects excessive heat.                               | <ol style="list-style-type: none"> <li>1. Ensure that the ambient temperature falls within the specified temperature range.</li> <li>2. Make sure that the ventilation holes are not obstructed.</li> <li>3. Provide enough spacing for adequate ventilation.</li> </ol>  |
| Alarm LED flashes five times in every two seconds (Low voltage)  | The AC drive detects that the DC Bus Voltage has fallen below its minimum value.      | Check whether the input voltage falls within the rated AC Drive input voltage.  |
| Alarm LED flashes  | Change DIP SW while drive is running  | Switch the Run/Stop key to Stop mode to reset the AC drive.   |

## Standard Specifications

| Voltage Class                         |                            | 115V Class   |  |            |          | 230V Class |  |            |          |      |
|---------------------------------------|----------------------------|--|--|------------|----------|------------|--|------------|----------|------|
| Model Number VFD□□□L□□A/B             |                            | 40W  |  | 001        |          | 40W        |  | 001        |          |      |
| Weight g (lb) A (standard)            |                            | 270 (0.60)   |  | 440 (0.97) |          | 260 (0.57) |  | 430 (0.95) |          |      |
| Weight g (lb) B (build-in EMI filter) |                            | 350 (0.77)   |  | 525 (1.16) |          | 340 (0.75) |  | 510 (1.12) |          |      |
| Max. Applicable Motor Output (W)      |                            | 25/40  |  | 60/100     |          | 25/40      |  | 60/100     |          |      |
| Output Rating                         | Rated Output Capacity (VA) |  | 106/152  |            | 212/303  |            | 106/152                                |            | 212/303  |      |
|                                       | Rated Output Current (A)   |  | 0.28/0.4   |            | 0.56/0.8 |            | 0.28/0.4                               |            | 0.56/0.8 |      |
|                                       | Maximum Output Voltage (V) |  | Two times proportion to Input Voltage  |            |          |            | Proportional to Input Voltage          |            |          |      |
|                                       | Rated Frequency (Hz)       |  | 1.00 to 120.00 Hz  |            |          |            |  |            |          |      |
| Input Rating                          | Rated Voltage/Frequency    |  | Single phase<br>100 to 120 VAC<br>50/60 Hz   |            |          |            | Single phase<br>200 to 240 VAC 50/60Hz |            |          |      |
|                                       | Voltage/Freq. Tolerance    |  | Voltage: ±10%, Frequency: ±5%  |            |          |            |  |            |          |      |
|                                       | Input Current (A)          |  | 1.1A   | 1.5A       | 2.2A     | 3.0A       | 0.5A                                   | 0.7A       | 1.0A     | 1.4A |
| Control Characteristics               | Control Systems            |  | SVPWM (Space Vector Pulse Width Modulation, carrier frequency 10kHz)                   |            |          |            |  |            |          |      |
|                                       | Torque Setting             |  | High/Low, Switching  |            |          |            |  |            |          |      |
|                                       | Overload Endurance         |  | 150% of rated current for 1 minute   |            |          |            |  |            |          |      |
|                                       | Accel/Decel Time           |  | 0.05 to 30.0 seconds   |            |          |            |  |            |          |      |
|                                       | Torque Promotion           |  | Torque Boots: 0 or 8%  |            |          |            |  |            |          |      |
| Operation Characteristics             | Frequency Setting          |  | Potentiometer  |            |          |            |  |            |          |      |
|                                       | Operation Setting Signal   | Panel  | RUN/STOP, FORWARD/REVERSE  |            |          |            |  |            |          |      |
|                                       |                            | Ext. Terminal  | RUN/STOP, FORWARD/REVERSE, RS-485  |            |          |            |  |            |          |      |
|                                       | Output Indiction           | Panel  | Fault Indication (LED Flash)   |            |          |            |  |            |          |      |
| Ext. Terminal                         |                            | Fault Indication (Open Collector)  |  |            |          |            |  |            |          |      |
| Protection                            |                            | Self-testing, Over Voltage, Over Current, Under Voltage, Overload, Overheating, Thermal. |  |            |          |            |  |            |          |      |
| Cooling                               |                            | Natural air-cooling  |  |            |          |            |  |            |          |      |
| Environment                           | Installation Location      |  | Altitude 1,000m or lower, keep from corrosive gasses, liquid and dust                  |            |          |            |  |            |          |      |
|                                       | Pollution Degree           |  | 2  |            |          |            |  |            |          |      |
|                                       | Ambient Temperature        |  | -10°C to 40°C (Non-Condensing and not frozen)  |            |          |            |  |            |          |      |
|                                       | Storage Temperature        |  | -20°C to 60°C  |            |          |            |  |            |          |      |
|                                       | Ambient Humidity           |  | Below 90% RH (non-condensing)  |            |          |            |  |            |          |      |
|                                       | Vibration                  |  | 9.80665m/s <sup>2</sup> (1G) less than 20Hz, 5.88m/s <sup>2</sup> (0.6G) at 20 to 50Hz |            |          |            |  |            |          |      |



# 15 Dimensions

