



VFD-L User Manual

Compact and Panel-installation Drives



115V 200W ~ 400W
230V 200W ~ 2HP



DELTA ELECTRONICS, INC.

www.delta.com.tw/industrialautomation

IABU Headquarters

Delta Electronics, Inc.

Taoyuan1

31-1, Xingbang Road, Guishan Industrial Zone,
Taoyuan County 33370, Taiwan, R.O.C.

TEL: 886-3-362-6301 / FAX: 886-3-362-7267

ASIA

Delta Electronics (Jiang Su) Ltd.

Wujiang Plant3

1688 Jiangxing East Road,
Wujiang Economy Development Zone,
Wujiang City, Jiang Su Province,
People's Republic of China (Post code: 215200)

TEL: 86-512-6340-3008 / FAX: 86-512-6340-7290

Delta Greentech (China) Co., Ltd.

238 Min-Xia Road, Cao-Lu Industry Zone, Pudong, Shanghai,
People's Republic of China

Post code: 201209

TEL: 021-58635678 / FAX: 021-58630003

Delta Electronics (Japan), Inc.

Tokyo Office

Delta Shibadaimon Building, 2-1-14
Shibadaimon, Minato-Ku, Tokyo, 105-0012,
Japan

TEL: 81-3-5733-1111 / FAX: 81-3-5733-1211

Delta Electronics (Korea), Inc.

234-9, Duck Soo Building 7F, Nonhyun-Dong,
Kangnam-Gu, Seoul, Korea 135-010

TEL: 82-2-515-5305 / FAX: 82-2-515-5302

Delta Electronics (Singapore) Pte. Ltd.

8 Kaki Bukit Road 2, #04-18 Ruby Warehouse Complex,
Singapore 417841

TEL: 65-6747-5155 / FAX: 65-6744-9228

Delta Power Solutions (India) Pte. Ltd.

Plot No. 28, Sector-34, EHTP
Gurgaon-122001 Haryana, India

TEL: 91-124-416-9040 / FAX: 91-124-403-6045

AMERICA

Delta Products Corporation (USA)

Raleigh Office

P.O. Box 12173, 5101 Davis Drive,
Research Triangle Park, NC 27709, U.S.A.

TEL: 1-919-767-3813 / FAX: 1-919-767-3969

Delta Products Corporation (Brazil)

Sao Paulo Office

Rua Jardim Ivone, 17 Cjs 13/14-Paraiso
04105-020-Sao Paulo-SP-Brazil

TEL: 55-11-3568-3875 / FAX: 55-11-3568-3865

EUROPE

Deltronics (The Netherlands) B.V.

Eindhoven Office

De Witbogt 15, 5652 AG Eindhoven, The Netherlands

TEL: 31-40-2592850 / FAX: 31-40-2592851

5011609500

200205-31



LE20



VFD-L User Manual Compact and Panel-installation Drives

Preface

Thank you for choosing DELTA's VFD-L series AC Drive. The VFD-L series is manufactured using high-quality components, material and incorporating the latest microprocessor technology available.

Getting Started

This manual will help in the installation, parameter setting, troubleshooting, and daily maintenance of the AC motor drive. To guarantee safe operation of the equipment, read the following safety guidelines before connecting power to the AC motor drive. Keep this operating manual handy and distribute to all users for reference.



WARNING



Always read this manual thoroughly before using VFD-L series AC Motor Drives.



DANGER! AC input power must be disconnected before any maintenance. Do not connect or disconnect wires and connectors while power is applied to the circuit. Maintenance must be performed by qualified technicians.



CAUTION! There are highly sensitive MOS components on the printed circuit boards. These components are especially sensitive to static electricity. To avoid damage to these components, do not touch these components or the circuit boards with metal objects or your bare hands.



DANGER! A charge may still remain in the DC-link capacitor with hazardous voltages even if the power has been turned off. To avoid personal injury, do not remove the cover of the AC drive until all "DISPLAY LED" lights on the digital keypad are off. Please note that there are live components exposed within the AC drive. Do not touch these live parts.



CAUTION! Ground the VFD-L using the ground terminal. The grounding method must comply with the laws of the country where the AC drive is to be installed. Refer to Basic Wiring Diagram.



DANGER! The AC drive may be destroyed beyond repair if incorrect cables are connected to the input/output terminals. Never connect the AC drive output terminals U/T1, V/T2, and W/T3 directly to the AC main circuit power supply.



CHAPTER 1 RECEIVING AND INSPECTIONS

1.1 Nameplate Information	1 - 1
1.2 Model Explanation	1 - 1
1.3 Serial Number Explanation	1 - 2

CHAPTER 2 STORAGE AND INSTALLATION

2.1 Storage	2 - 1
2.2 Installation	2 - 2

CHAPTER 3 WIRING

3.1 Basic Wiring Diagram	3 - 2
3.2 Terminal Explanation	3 - 3
3.3 Control Terminal Explanation	3 - 3
3.4 Main Circuit Wiring	3 - 4
3.5 Wiring Notes	3 - 5

CHAPTER 4 DIGITAL KEYPAD OPERATION

4.1 Description of the Digital Keypad VFD-PU01	4 - 1
4.2 Operation steps of the Digital Keypad VFD-PU01	4 - 2

CHAPTER 5 DESCRIPTION OF PARAMETER SETTINGS

Group 0: User Parameters	5 - 1
Group 1: Basic Parameters	5 - 4
Group 2: Operating Method Parameters	5-10
Group 3: Output Function Parameters	5-13



Group 4: Input Function Parameters	5-16
Group 5: Multi-step Speed and PLC (Process Logic Control) Parameter..	5-27
Group 6: Protection Parameters	5-32
Group 7: Motor Parameters	5-35
Group 8: Special Parameters	5-36
Group 9: Communication Parameters	5-40
CHAPTER 6 MAINTENANCE AND INSPECTIONS	
6.1 Periodic Inspection	6 - 1
6.2 Periodic Maintenance	6 - 1
CHAPTER 7 TROUBLESHOOTING AND FAULT INFORMATION.....	7 - 1
CHAPTER 8 SUMMARY OF PARAMETER SETTINGS.....	8 - 1
APPENDIX A SPECIFICATIONS	A - 1
APPENDIX B ACCESSORIES	
B.1 Non-fused Circuit Breaker and Fuse Specification Chart	B - 1
APPENDIX C DIMENSIONS.....	C - 1
APPENDIX D EC DECELERATION OF CONFORMITY	D - 1

CHAPTER 1 RECEIVING AND INSPECTION

1

This VFD-L AC drive has gone through rigorous quality control tests at the factory before shipment. After receiving the AC drive, please check for the following:

Receiving

- ✓ Check to make sure that the package includes an AC drive, the User Manual, dust covers and rubber bushings.
- ✓ Inspect the unit to insure it was not damaged during shipment.
- ✓ Make sure that the part number indicated on the nameplate corresponds with the part number of your order.

1.1 Nameplate Information: Example for 1HP/230V AC drive

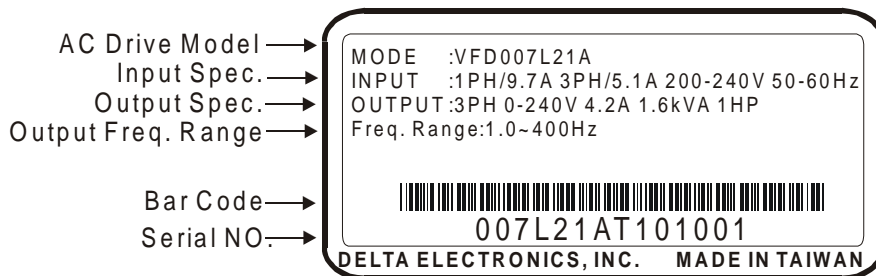

1.2 Model Explanation:

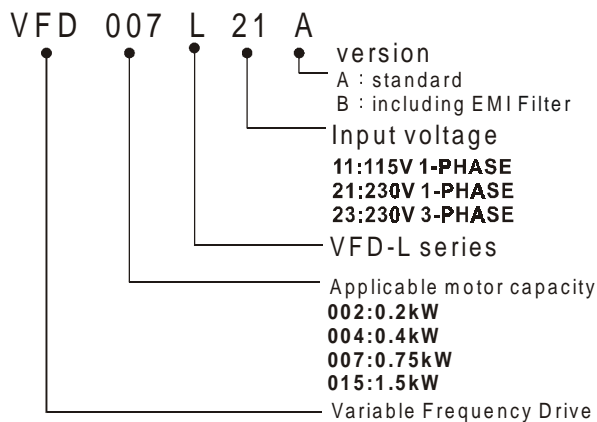



1.3 Series Number Explanation:

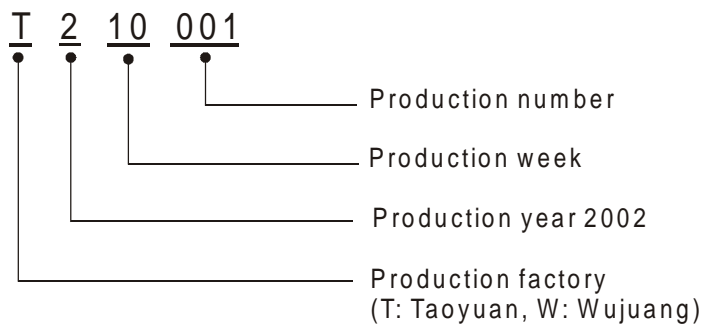

If there is any nameplate information not corresponding to your purchase order or any problem, please contact your distributor.

CHAPTER 2 STORAGE AND INSTALLATION

2.1 Storage

The AC drive should be kept in the shipping carton before installation. In order to retain the warranty coverage, the AC drive should be stored properly when it is not to be used for an extended period of time.

2

Ambient Conditions:

Operation	Air Temperature: -10°C to $+40^{\circ}\text{C}$ (14°F to 104°F) Atmosphere pressure: 86 to 106 kPa Installation Site Altitude: below 1000m Vibration: Maximum 9.86 m/s^2 (1G) at less than 20Hz Maximum 5.88 m/s^2 (1G) at 20Hz to 50Hz
Storage	Temperature: -20°C to $+60^{\circ}\text{C}$ (-4°F to 140°F) Relative Humidity: Less than 90%, no condensation allowed Atmosphere pressure: 86 to 106 kPa
Transportation	Temperature: -20°C to $+60^{\circ}\text{C}$ (-4°F to 140°F) Relative Humidity: Less than 90%, no condensation allowed Atmosphere pressure: 86 to 106 kPa Vibration: Maximum 9.86 m/s^2 (1G) at less than 20Hz, Maximum 5.88 m/s^2 (1G) at 20Hz to 50Hz
Pollution Degree	2: good for a factory type environment.



2.2 Installation:



CAUTION

The control, power supply and motor leads must be laid separately. They must not be fed through the same cable conduit / trunking.

High voltage insulation test equipment must not be used on cables connected to the drive.

Improper installation of the AC drive will greatly reduce its life. Be sure to observe the following precautions when selecting a mounting location.

Failure to observe these precautions may void the warranty!

- ◆ Do not mount the AC drive near heat-radiating elements or in direct sunlight.
- ◆ Do not install the AC drive in a place subjected to high temperature, high humidity, excessive vibration, corrosive gases or liquids, or airborne dust or metallic particles.
- ◆ Mount the AC drive vertically and do not restrict the air flow to the heat sink fins.
- ◆ The AC drive generates heat. Allow sufficient space around the unit for heat dissipation.

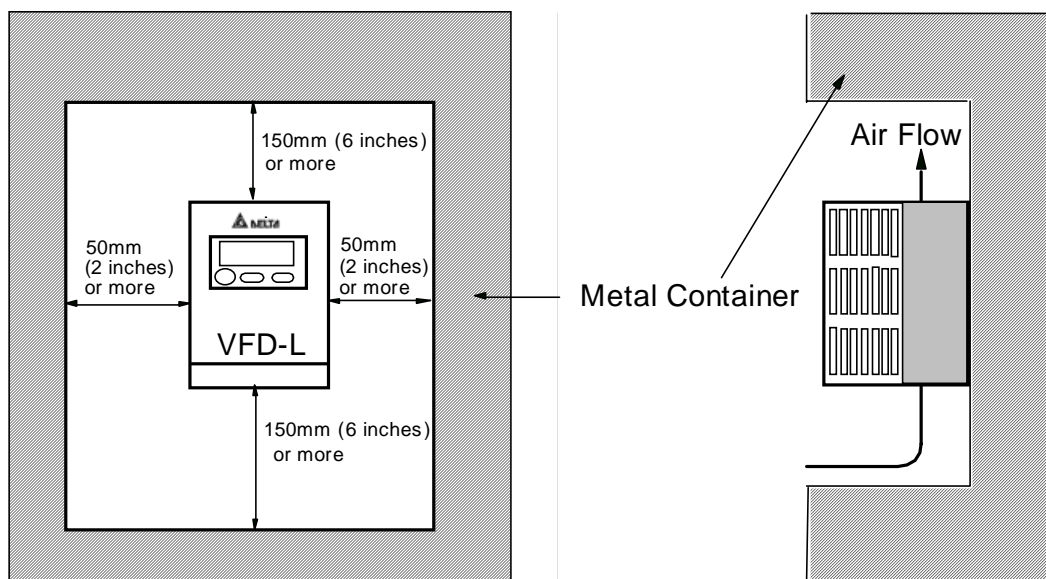

Minimum Clearances and Air Flow

CHAPTER 3 WIRING



DANGER

Hazardous Voltage

Before accessing the AC drive:

- ◆ Disconnect all power to the AC drive.
- ◆ Wait five minutes for DC bus capacitors discharge.

3

Any electrical or mechanical modification to this equipment without prior written consent of Delta Electronics, Inc. will void all warranties and may result in a safety hazard in addition to voiding the UL listing.



General Wiring Information

Applicable Codes

All VFD-L AC drives are Underwriters Laboratories, Inc. (UL) and Canadian Underwriters Laboratories (cUL) listed, and therefore comply with the requirements of the National Electrical Code (NEC) and the Canadian Electrical Code (CEC).

Installation intended to meet the UL and cUL requirements must follow the instructions provided in "Wiring Notes" as a minimum standard. Follow all local codes that exceed UL and cUL requirements. Refer to the technical data label affixed to the AC drive and the motor nameplate for electrical data.

The "Line Fuse Specification" in Appendix B, lists the recommended fuse part number for each B-Series part number. These fuses (or equivalent) must be used on all installations where compliance with U.L. standards is a required.



3.1 Basic Wiring Diagram

Users must connect wiring according to the circuit diagram shown below. Please follow all National and State wiring codes, when wiring the VFD-L.

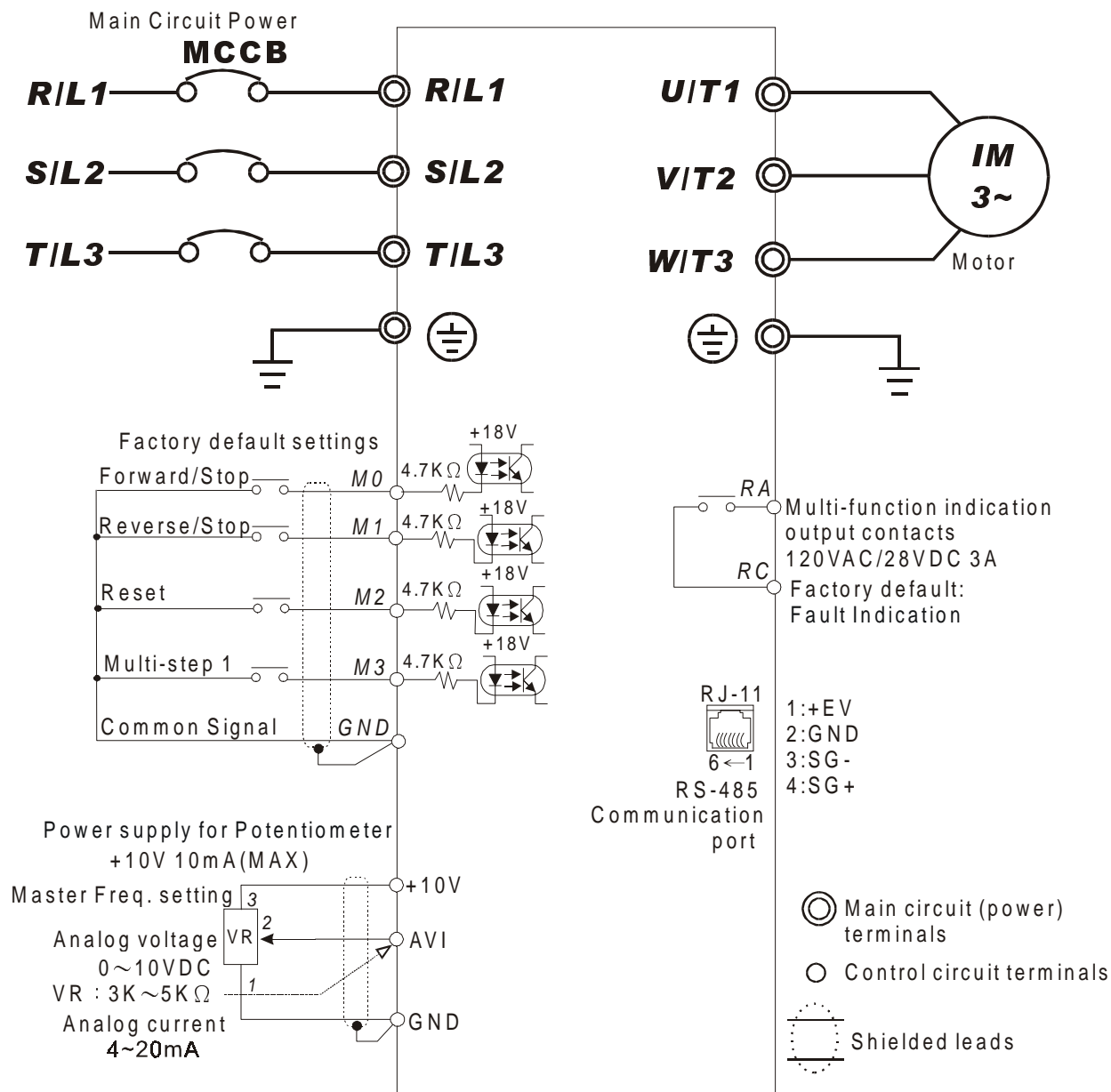

NOTE: Do not plug in a Modem or telephone line to the RS-485 communication port, permanent damage may result. Terminals 1 & 2 are the power source for the optional copy keypad and should not be used while using RS-485 communication.

*If the AC Drive model is VFD002L11A/B, VFD004L11A/B, VFD002L21B, VFD004L21B or VFD007L21B, please use power terminals R/L1 and S/L2.

*If the AC Drive model is VFD002L21A, VFD004L21A or VFD007L21A, 3 phase power may be used on R/L1, S/L2, T/L3.

*If the AC Drive model is VFD015L23A, single phase power is not allowed.

3.2 Terminal Explanations

Terminal Symbol	Explanation of Terminal Function
R/L1, S/L2, T/L3	AC line input terminals
U/T1, V/T2, W/T3	AC drive output terminals motor connections
	Earth Ground

3

3.3 Control Terminals Explanations

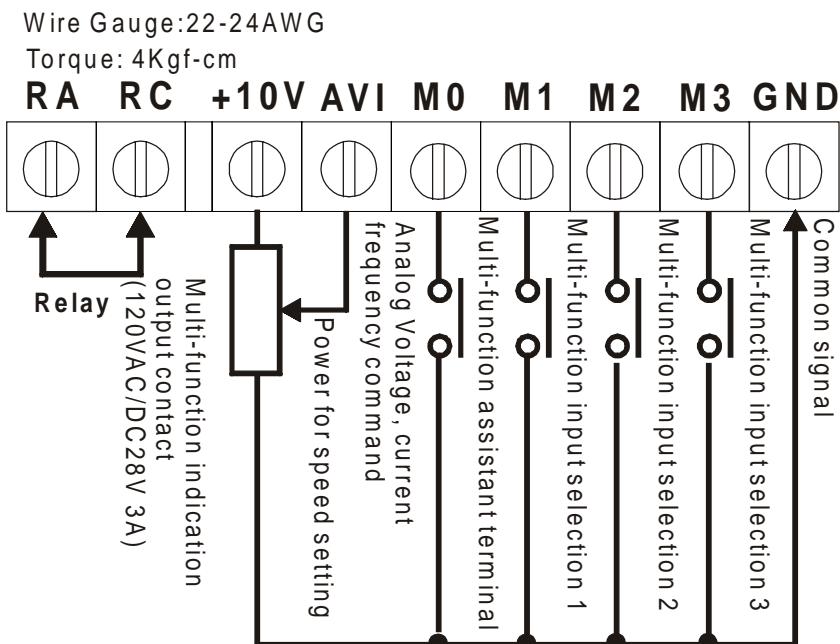

Terminal Symbols	Terminal Functions	Factory Settings
MI0	Multi-function Input 0	Refer to Pr.04-04 to Pr.04-06 Multi-function Input Terminals
MI1	Multi-function Input 1	
MI2	Multi-function Input 2	
MI3	Multi-function Input 3	
RA	Multi-function Relay output (N.O.) a	120Vac, 3A 24Vdc, 3A
RC	Multi-function Relay common	Refer to Pr.03-03
+10V	Potentiometer power source	+10V 20mA
AVI	Analog voltage/ Input current	0 to +10V / 4 to 20mA

* Control signal wiring size: 22-24 AWG (0.3-0.2 mm²).



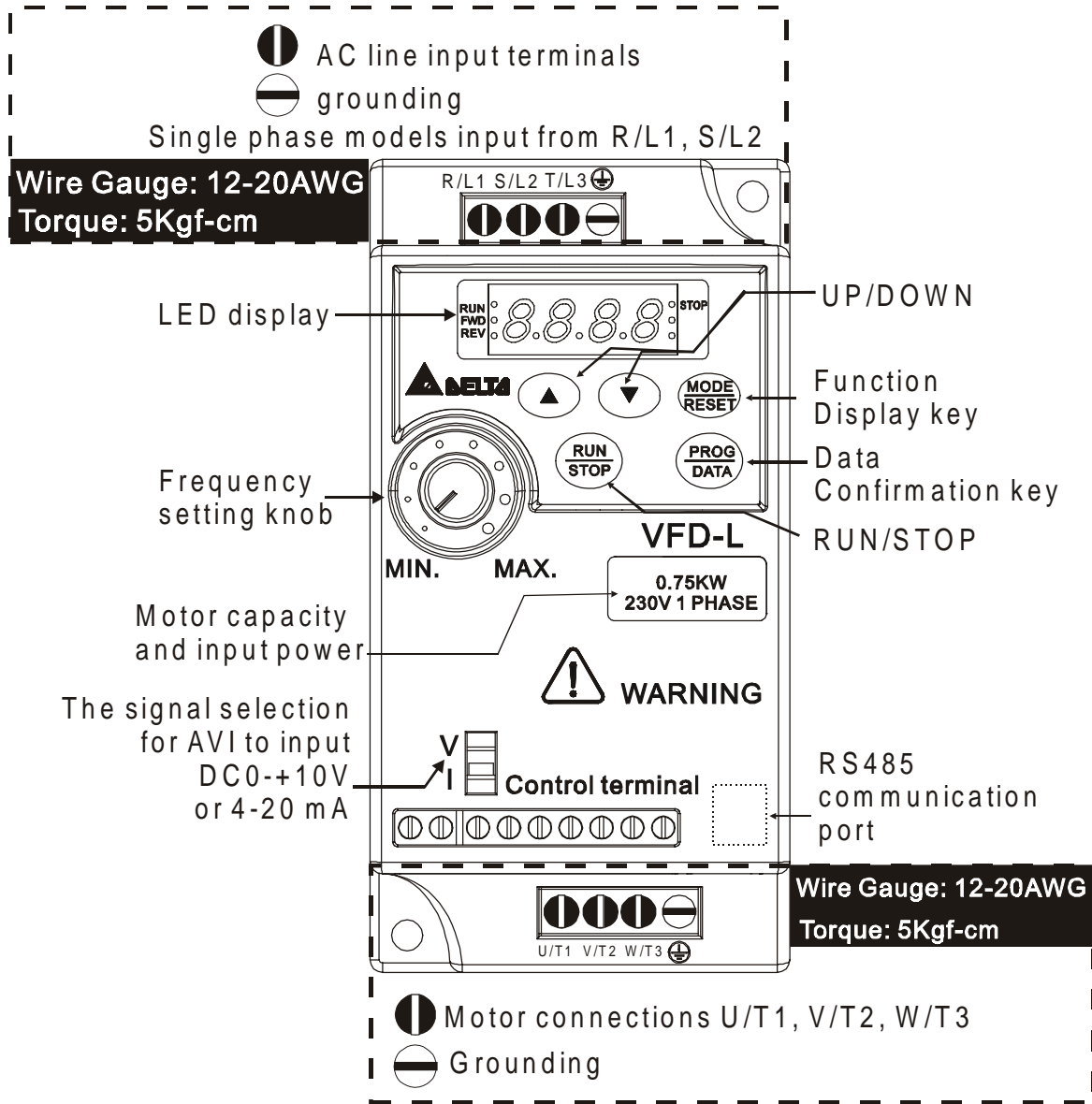

3.4 Main Circuit Wiring



Control Terminal
 Torque: 4Kgf-cm (3 in-lbf)
 Wire: 22-24 AWG

Power Terminal
 Torque: 5Kgf-cm (4.33 in-lbf)
 Wire: 12-20 AWG

3.5 Wiring Notes: PLEASE READ PRIOR TO INSTALLATION.

1.  **CAUTION:** Do not connect the AC power to the U/T1, V/T2, W/T3 terminals, as it will damage the AC drive.
2.  **WARNING:** Ensure all screws are tightened to the proper torque rating.
3. During installation, follow all local electrical, construction, and safety codes for the country the drive is to be installed in.
4. Ensure that the appropriate protective devices (circuit breaker or fuses) are connected between the power supply and AC drive.
5. Make sure that the leads are connected correctly and the AC drive is properly grounded. (Ground resistance should not exceed 0.1 Ω .)
6. Use ground leads that comply with AWG/MCM standards and keep them as short as possible.
7. Multiple VFD-L units can be installed in one location. All the units should be grounded directly to a common ground terminal. The VFD-L ground terminals may also be connected in parallel, as shown in the figure below. **Ensure there are no ground loops.**

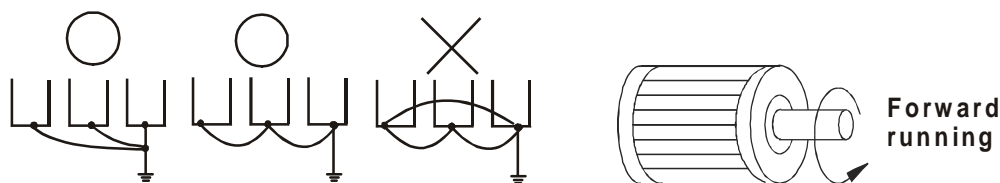

8. When the AC drive output terminals U/T1, V/T2, and W/T3 are connected to the motor terminals U/T1, V/T2, and W/T3, respectively, the motor will rotate counterclockwise (as viewed from the shaft ends of the motor) when a forward operation command is received. To reverse the direction of motor rotation, switch over any of the two motor leads.
9. Make sure that the power source is capable of supplying the correct voltage and required current to the AC drive.
10. Do not attach or remove wiring when power is applied to the AC drive.



11. Do not monitor the signals on the circuit board while the AC drive is in operation.
12. For the single-phase rated AC drives, the AC power can be connected to any two of the three input terminals R/L1, S/L2, T/L3. **Note: This drive is not intended for the use with single-phase motors.**
13. Route the power and control wires separately, or at 90 ° angle to each other.
14. If a filter is required for reducing EMI (Electro Magnetic Interference), install it as close as possible to AC drive. EMI can also be reduced by lowering the Carrier Frequency.
15. If the AC drive is installed in the place where a load reactor is needed, install the filter close to U/T1, V/T2, W/T3, side of AC drive. Do not use a Capacitor or L-C Filter (Inductance-Capacitance) or R-C Filter (Resistance-Capacitance), unless approved by Delta.
16. When using a GFCI (Ground Fault Circuit Interrupt), select current sensor with sensitivity of 200mA, and not less than 0.1-second detection to avoid nuisance tripping.

CHAPTER 4 DIGITAL KEYPAD OPERATION

4.1 Description of Digital Keypad

This digital keypad includes two parts: Display panel and keypad. Display panel provides the parameter display and shows operation status of the AC drive. Keypad provides programming interface between users and AC drives.

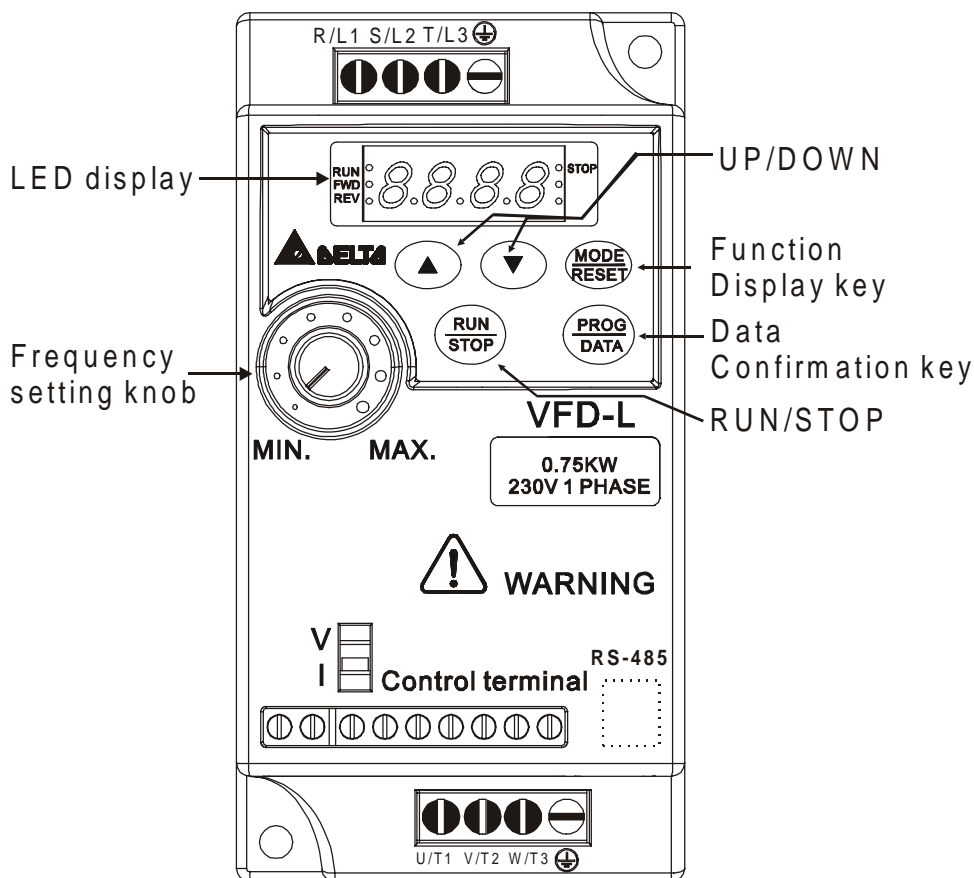

Mode/Reset

By pressing the “mode” key repetitively, the display will show status at the AC drive such as the reference frequency, output frequency, and output current. If the drive stops due to a fault, correct the fault first, then press this key to reset the drive.



PROG/DATA

Pressing the “PROG/DATA” key will store entered data or can show factory stored data.



Run/Stop

Press to Start or Stop the AC drive operation. This key can only be used to Stop the AC Drive when the drive is controlled by the External Control Terminals.

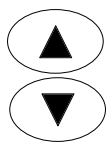

Up / Down

Press the “Up” or “Down” keys momentarily to change parameter settings. These keys may also be used to scroll through different operating values or parameters. Pressing the “Up” or “Down” key momentarily, will change the parameter settings in single-unit increments. To quickly run through the range of settings, press down and hold the key.

4.2 Explanations of Display Messages

Display Message	Descriptions
	The AC drive Master Frequency
	The Actual Operation Frequency present at terminals U/T1, V/T2, and W/T3.
	The output current present at terminals U/T1, V/T2, and W/T3
	The custom unit (u), where u = H x Pr 0-05.
	The counter value (C)
	The internal PLC process step currently being performed.
	The DC-BUS voltage
	The output voltage
	The specified parameter group
	The specified parameter
	The actual value stored within the specified parameter.
	AC drive forward run status
	AC drive reverse run status
	“End” displays for approximately 0.5 second if input has been accepted. After a parameter value has been set, the new value is automatically stored in memory. To modify an entry, use the and keys.
	“Err” displays, if the input is invalid.

CHAPTER 5 DESCRIPTION OF PARAMETER SETTINGS

Group 0: User Parameters

0 - 00 Identity Code of AC Motor Drive Factory setting: d #

Settings None

Watts / hp	40W	100W	1/4hp	1/2hp	1hp	2hp
115V / 230V	d 1	d 2	d 3	d 4	d 5	d 6

 This parameter shows the capacity of the AC drive. Users can read Pr.0-01 to check if it is the rated current of the AC drive corresponds to the identity code shown above and the current shown below.

0 - 01 Rated Current Display of the AC drive Factory Setting: d ###

Settings None Unit: 0.1A

V / HP	40W	100W	1/4hp	1/2hp	1hp	2hp
115V / 230V	0.4A	0.8A	1.6A	2.5A	4.2A	7.0A

 This parameter displays the rated current of the AC drive. It will display based on Pr.0-00, and is read-only.

0 - 02 Parameter Reset Factory Setting: d 0

Settings d 0 to d 9 Not used
 d 10 All parameters are reset to be factory settings

 This setting allows the user to return all parameters to the factory default settings.

0 - 03 Start-up Display Selection Factory Setting: d 0

Settings d 0 Display the Master Frequency (F)
 d 1 Display the actual operation frequency (H)
 d 2 Display the content of users-defined unit
 d 3 Display the output current (A)

This parameter can be set during operation.

**0 - 04****Content of User Defined Unit**

Factory Setting: d 0

Settings	d 0	Display the user-defined unit (u)
	d 1	Display the counter value (C)
	d 2	Display the content of PLC time (1 – tt)
	d 3	Display the DC BUS voltage (U)
	d 4	Display the output voltage (E)

This parameter can be set during operation.

Note: Display the user-defined unit, where unit = H ×

0-05**0 - 05****User Defined Coefficient K**

Factory Setting: d 1.0

Settings	d 0.1 to d 160	Unit: 0.1
----------	----------------	-----------

This parameter can be set during operation.



The coefficient K determines the multiplying factor for the user-defined unit.

The display value is calculated as follows:

$$\text{Display value} = (\text{output frequency} \times K)$$



The display window is only capable of showing three digits, yet you could use Pr.0-05 to create larger numbers. The display windows uses decimal points to signify numbers up to five digits as illustrated in the next page:

Display	Number Represented
999	The absence of a decimal point indicates a three –digit integer.
99.9	A signal decimal point between the middle and the right-most numbers is a true decimal point; it separates ones and tenths as in “30.5” (thirty and one-half).
999.	A single decimal point after the right-most numbers is not a true decimal point; instead it indicates that a zero follows the right-most number. For example, the number 1230 would be display as “123.”
99.9.	Two decimal points (one between the middle and the right-most numbers, and one after the right-most number) are not true decimal points; instead they indicate that two zeros follow the right-most number. For example, the number 34500 would be display as “34.5.”

0 - 06 Software Version

Factory Setting: d #.#

Setting None

-  The software version is read-only that stores the version number of VFD-L series software.

0 - 07 Password Input

Factory Setting: d 0

Settings d 0 to d 999

Unit: 1

-  Pr.0-07 and Pr.0-08 work together to provide data security for the AC drive. When Pr.0-08 is set to a value other than 0, a password must be entered to alter the values of parameters. The password is the number set in Pr.0-08, which ranges from 1 to 999. Pr.0-07 is where the password is entered to allow parameter values to be altered.

-  Display states:

d 0: no password / correct password has been input

d 1: parameters are locked

0 - 08 Password Configuration

Factory Setting: d 0

Settings d 0 to d 999

Unit: 1

-  For a password to be configured, the non-zero value assigned to Pr.0-08 must be entered **twice**. In other words, set the value of Pr.0-08 to the desired value and press the PROG/DATA key. Then, press the PROG/DATA key again to display the value of Pr.0-08. Finally, press the PROG/DATA key again to store the displayed value, which then becomes the password.

For example, say that Pr.0-08 is set to 111. When the AC drive is powered-up, all the parameters will be locked and their values cannot be changed. To permit the values of parameters to be altered, navigate to Pr.0-07 and change its value to 111 (the password configured in Pr.0-08). Then press the PROG/DATA key, and you may alter the parameter values.

-  Display states:

d 0: no password

d 1: password has been set



Group 1: Basic Parameters

1 - 00	Maximum Output Frequency (Fo. max)	Factory Setting: d 60.0
	Settings d 50.0 to d 400 Hz	Unit: 0.1Hz

 This parameter determines the AC drive's Maximum Output Frequency. All the AC drive analog inputs (0 to +10V, 4 to 20mA) are scaled to correspond to the output frequency range.

1 - 01	Maximum Voltage Frequency	Factory Setting: d 60.0
	Settings d 10.0 to d 400Hz	Unit: 0.1Hz

 This value should be set according to rated frequency of the motor as indicated on the motor nameplate. Maximum Voltage Frequency determines the volts per hertz ratio. For example, if the drive is rated for 460 VAC output and the Maximum Voltage Frequency is set to 60Hz, the drive will maintain a constant ratio of 7.66 v/Hz. The setting value must be greater than or equal to the middle freq. setting (Pr.1-03).

1 - 02	Max. Output Voltage (Vmax)	Factory Setting: d 220
	Settings d 2.0 to d 255V	Unit: 0.1V

 This parameter determines the Maximum Output Voltage of the AC drive. The Maximum Output Voltage setting must be smaller than or equal to the rated voltage of the motor as indicated on the motor nameplate. The setting value must be greater than or equal to the Mid-Point Voltage (Pr.1-04).

1 - 03	Mid-Point Frequency (Fmid)	Factory Setting: d 1.0
	Settings d 1.0 to d 400Hz	Unit: 0.1Hz

 This parameter sets the Mid-Point Frequency of V/F curve. With this setting, the V/F ratio between Minimum Frequency and Mid-Point frequency can be determined. This parameter must be greater than or equal to Minimum Output Frequency (Pr.1-05) and equal to or less than Maximum Voltage Frequency (Pr.1-01).



1 - 04	Mid-Point Voltage (Vmid)	Factory Setting: d12.0
Settings	d 2.0 to d 255V	Unit: 0.1V

The parameter sets the Mid-Point Voltage of any V/F curve. With this setting, the V/F ratio between Minimum Frequency and Mid-Point Frequency can be determined. This parameter must be equal to or greater than Minimum Output Voltage (Pr.1-06) and equal to or less than Maximum Output Voltage (Pr.1-02).

1 - 05	Minimum Output Frequency (Fmin)	Factory Setting: d 1.0
Settings	d 1.0 to d 60.0Hz	Unit: 0.1Hz

This parameter sets the Minimum Output Frequency of the AC drive. This parameter must be equal to or less than Mid-Point Frequency (Pr.1-03).

1 - 06	Minimum Output Voltage (Vmin)	Factory Setting: d12.0
Settings	d 2.0 to d 255V	Unit: 0.1V

This parameter sets Minimum Output Voltage of the AC drive. This parameter must be equal to or less than Mid-Point Voltage (Pr.1-04).

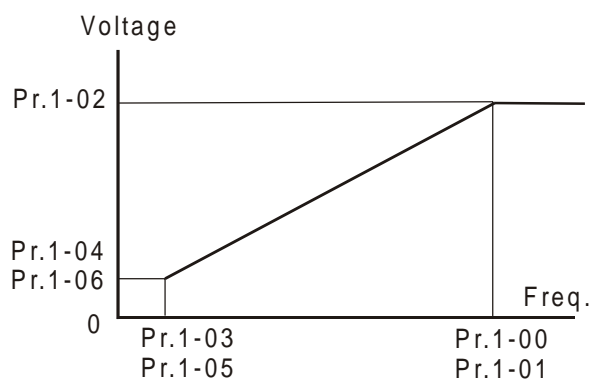

Standard V/F Curve

1 - 07	Upper Bound of Output Frequency	Factory Setting: d 100
Settings	d 1 to d110%	Unit: 1%

This parameter must be equal to or greater than the Lower Bound of Output Frequency (Pr.1-08). The Maximum Output Frequency (Pr.1-00) is regarded as 100%.

**1 - 08****Lower Bound of Output Frequency****Factory Setting: d 0**

Settings d 0 to d100%

Unit: 1%



The Upper/Lower Bound is to prevent operation error and machine damage.



If the Upper Bound of Output Frequency is 50Hz and the Maximum Output Frequency is 60Hz, the Maximum Output Frequency will be limited to 50Hz.



If the Lower Bound of Output Frequency is 10Hz, and the Minimum Output Frequency (Pr.1-05) is set at 1.0Hz, then any Command Frequency between 1-10Hz will generate a 10Hz output from the drive.



This parameter must be equal to or less than the Upper Bound of Output Frequency (Pr.1-07).

1 - 09**Acceleration Time 1 (Taccel 1)****Factory Setting : d10.0****1 - 10****Deceleration Time 1 (Tdecel 1)****Factory Setting : d10.0****1 - 11****Acceleration Time 2 (Taccel 2)****Factory Setting : d10.0****1 - 12****Deceleration Time 2 (Tdecel 2)****Factory Setting : d10.0**

Settings d 0.1 to d 600Sec

Unit: 0.1Sec

These parameters can be set during operation.



Pr.1-09. This parameter is used to determine the time required for the AC drive to ramp from 0 Hz to its Maximum Output Frequency (Pr.1-00). The rate is linear unless S-Curve is “Enabled.”



Pr.1-10. This parameter is used to determine the time required for the AC drive to decelerate from the Maximum Output Frequency (Pr.1-00) down to 0 Hz. The rate is linear unless S-Curve is “Enabled.”



The accel/decel time 2 determines the time for the AC drive to accel/decel from 0Hz to Maximum Output Frequency (Pr.1-00) (accel/decel time 1 is the default). A Multi-Function Input terminals must be programmed to select accel/decel time 2 and the terminals must be closed to select accel/decel time 2. See Pr.4-04 to Pr.4-08.



In the diagram shown below, the accel/decel time of the AC drive is the time between 0 Hz to Maximum Output Frequency (Pr.1-00). Suppose the Maximum Output Frequency is 60 Hz, start-up frequency (Pr.1-05) is 1.0 Hz, and accel/decel time is 10 seconds. The actual time for the AC drive to accelerate from start-up to 60 Hz is 9.83 seconds and the deceleration time is also 9.83 seconds.

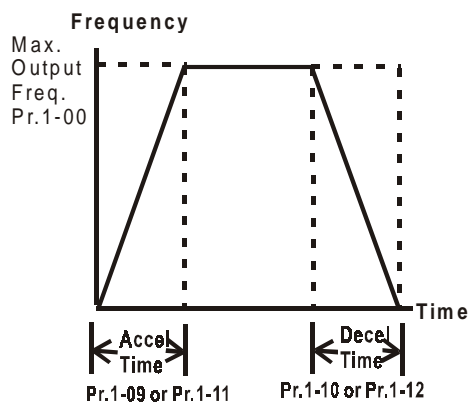

$$\text{Actual Accel/Decel Time} = \frac{\text{Accel/Decel Time} \times (\text{Master Freq.} - \text{Min. Output Freq.})}{\text{Max. Output Freq.}}$$

1 - 13	Jog Accel Time	Factory Setting: d 10.0
---------------	-----------------------	--------------------------------

Settings	d 0.1 to d 600Sec	Unit: 0.1Sec
----------	-------------------	--------------

This parameter can be set during operation.

1 - 14	Jog Decel Time	Factory Setting: d 10.0
---------------	-----------------------	--------------------------------

Settings	d 0.1 to d 600Sec	Unit: 0.1Sec
----------	-------------------	--------------

This parameter can be set during operation.

1 - 15	Jog Frequency	Factory Setting : d 6.0
---------------	----------------------	--------------------------------

Settings	d 1.0 to d 400Hz	Unit: 0.1Hz
----------	------------------	-------------

This parameter can be set during operation.



The JOG function can be selected using Multi-function Input terminals (Pr.4-04 to Pr.4-08) if programmed for Jog (d10). When the Jog terminal is “closed”, the AC drive will accelerate from Minimum Output Frequency (Pr.1-05) to Jog Frequency (Pr.1-14). When the Jog terminal “open”, the AC drive will decelerate from Jog Frequency to zero. The accel/decel time is decided by the Jog accel/decel time (Pr.1-13). During operation, the AC drive can not perform Jog command. And during Jog operation, other operation commands can not be accepted, except command of RUN/STOP key on the digital keypad.

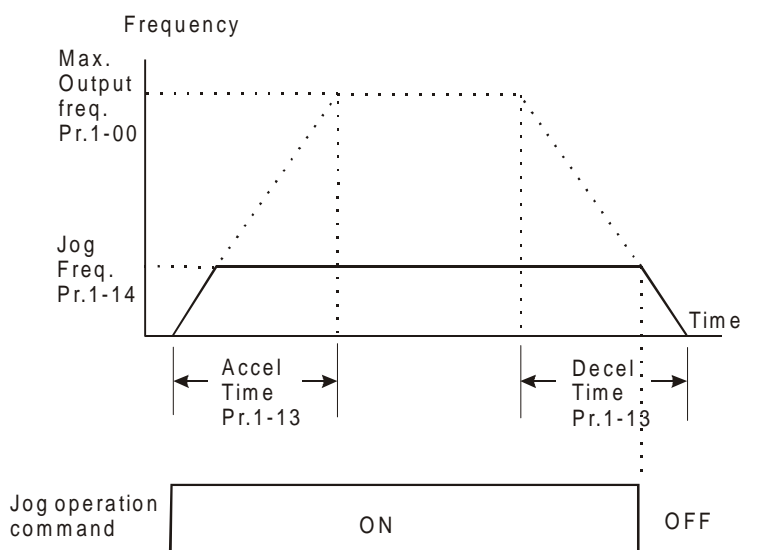

1 - 16 Auto-Acceleration / Deceleration Factory Setting : d 0

Settings	d 0	Linear acceleration / deceleration.
	d 1	Auto acceleration, linear Deceleration.
	d 2	Linear acceleration, auto Deceleration.
	d 3	Auto acceleration / deceleration
	d 4	Linear acceleration/deceleration, and stall prevention during deceleration.
	d 5	Auto acceleration, linear deceleration, and stall prevention during deceleration



If the auto accel/decel is selected, the AC drive will accel/ decel in the fastest and smoothest means possible by automatically adjusting the time of accel/decel.

1 - 17 Acceleration S-Curve Factory Setting: d 0

Settings d 0 to d 7

1 - 18 Deceleration S-Curve Factory Setting: d 0

Settings d 0 to d 7



These two parameters allow you to configure whether the acceleration and/or deceleration ramps are linear or S-shaped. The S-curve is enabled when set at d1-d7. Setting d1 offers the quickest S-curve and d7 offers the longest and smoothest S-curve. The AC drive will not follow the accel/decel time in Pr.1-09 to Pr.1-12. To Disable the S-curve, set Pr.1-16 and Pr.1-17 to d0.



From the diagram shown below, the original setting accel/decel time will be for reference when the function of the S-curve is enabled. The actual accel/decel time will be determined based on the S-curve selected (d1 to d7).

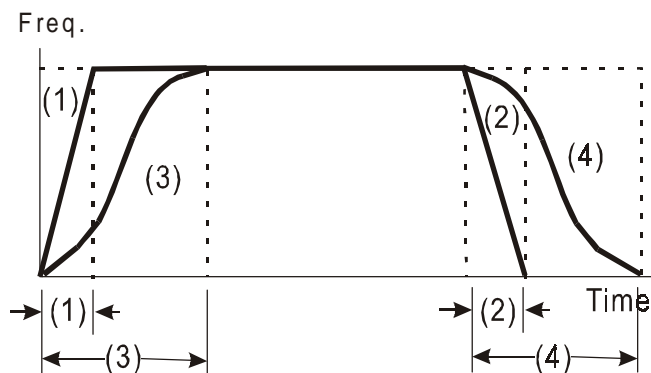

Accel/Decel characteristics
 (1), (2) Disabling S curve
 (3), (4) Enabling S curve



Group 2: Operation Method Parameters

2 - 00	Source of Frequency Command	Factory Setting: d 0
Settings	d 0	Master Frequency input determined by digital keypad.
	d 1	Master Frequency determined by analog signal DC 0V-10V (external terminal AVI).
	d 2	Master Frequency determined by analog signal DC 4mA - 20mA (external terminal AVI).
	d 3	Master Frequency determined by Potentiometer on the digital keypad.
	d 4	Master Frequency operated by RS-485 serial communication interface.



This parameter sets the Frequency Command Source of the AC drive.

If the Frequency Command Source is external (DC 0 to +10V or 4 to 20mA), please select DC voltage signal or current signal.



2 - 01	Source of Operation Command	Factory Setting: d 0
Settings	d 0	Controlled by the keypad
	d 1	Controlled by the external terminals, keypad STOP enabled.
	d 2	Controlled by the external terminals, keypad STOP disabled.
	d 3	Controlled by the RS-485 communication interface, keypad STOP enabled.
	d 4	Controlled by the RS-485 communication interface, keypad STOP disabled.



When the AC drive is controlled by an external source, please refer to parameter group 4 for detailed explanations on related parameter settings.

2 - 02	Stop Method	Factory Setting: d 0
Settings	d 0	Ramp stop
	d 1	Coast stop



The parameter determines how the motor is stopped when the AC drive receives a valid stop command.

1. Ramp: the AC drive decelerates the motor to Minimum Output Frequency (Pr.1-05) and then stops according to the deceleration time set in Pr.1-10 or Pr.1-12.
2. Coast: the AC drive stops output instantly upon command, and the motor free runs until it comes to a complete stop.

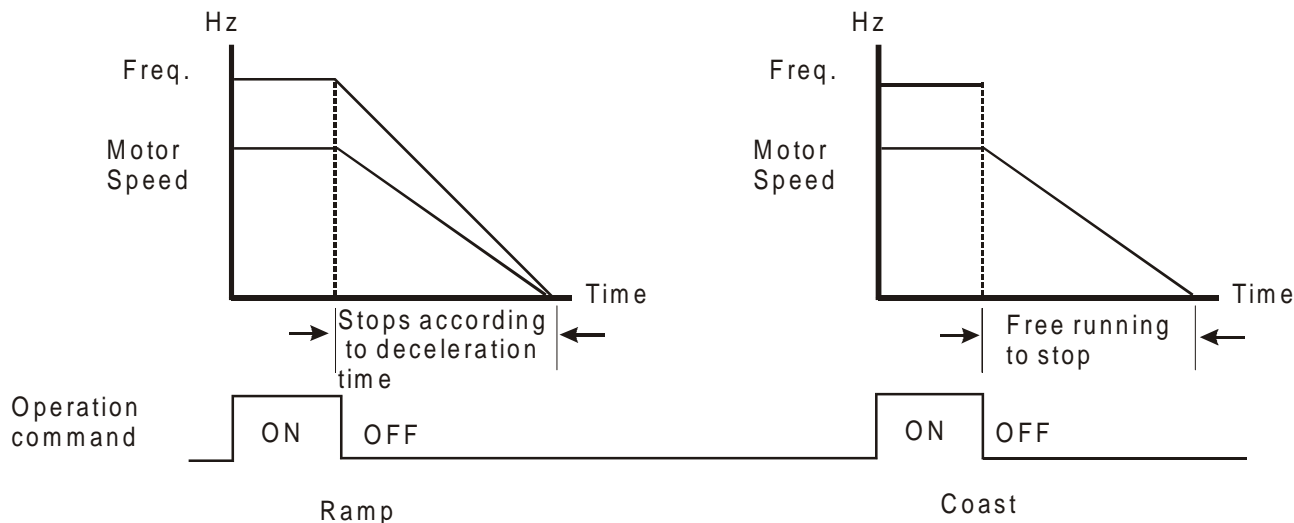

5

Note: The motor stop method is usually determined by the characteristics of the motor load and frequency of stops.

2 - 03	PWM Carrier Frequency Selections	Factory Setting: d 10
Settings	d 03 fc= 3KHz d 04 fc= 4KHz d 05 fc= 5KHz to d 10 fc= 10KHz	Unit: 1KHz

This parameter can set the carrier frequency of PWM output.

Carrier Frequency	Acoustic Noise	Electromagnetic Noise, Leakage Current	Heat Dissipation
3KHz	Significant	Minimal	Minimal
10KHz	Minimal	Significant	Significant



From the above table, we see that the carrier frequency of PWM output has a significant influence on the electromagnetic noise, heat dissipation of the AC drive, and the acoustic noise to the motor.

2 - 04 Reverse Operation Inhibit Factory Setting: d 0

Settings	d 0	enable Reverse operation
	d 1	disable Reverse operation
	d 2	disable Forward operation

The parameter determines whether the AC drive can operate in the reverse or forward directions.

2 - 05 Loss of ACI Input Factory Setting: d 0

Settings	d 0	Upon the loss of ACI, the drive will default to an output frequency of 0 Hz.
	d 1	Upon the loss of ACI, the drive will stop and display error message "EF".
	d 2	Upon the loss of ACI, the drive will continue to run at the last known ACI input.

This parameter is only effective when the Source of Frequency is commanded by a 4 to 20 mA signal. The ACI input is considered lost when the ACI signal falls below 2 mA.

2 - 06 Line Start Lockout Factory Setting: d 0

Settings	d 0	enable
	d 1	disable

When enabled, the AC drive will not start when powered up with run commands applied. To start in Line Start Lockout mode, the AC drive must see the run command go from stop to run after power up. When Line Start Lockout is disable (also known as Auto-Start), the drive will start when powered-up with run commands applied.

Group 3: Output Function Parameters

3 - 00	Desired Frequency Attained	Factory Setting: d 1.0
Settings	d 1.0 to d 400 Hz	Unit: 0.1Hz



If a Multi-function output terminal is set to function as Desired Frequency Attained (Pr.3-03=d9), then the output will be activated when the programmed frequency is attained.

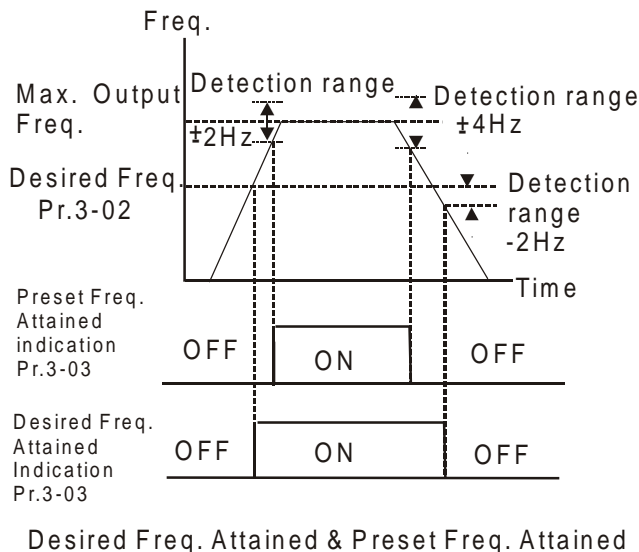

3 - 01	Terminal Count Value	Factory Setting: d 0
Settings	d 0 to d 999	



The parameter determines the value of the internal counter. The internal counter can be triggered by the external terminal (Pr.4-4 to Pr.4-6, d18). Upon completion of counting, the specified output terminal will be activated. (Pr.3-03=d14).

3 - 02	Preliminary Count Value	Factory Setting: d 0
Settings	d 0 to d 999	



When the counter value is counted up from "1" to the setting value of this parameter, the corresponding multi-function output terminal will be closed, when sets d15 as desired value attained setting. The application can be that closing the multi-function output terminal makes the AC drive operate at low speed until stop before the counting value is going to be attained.



The timing diagram is shown below:

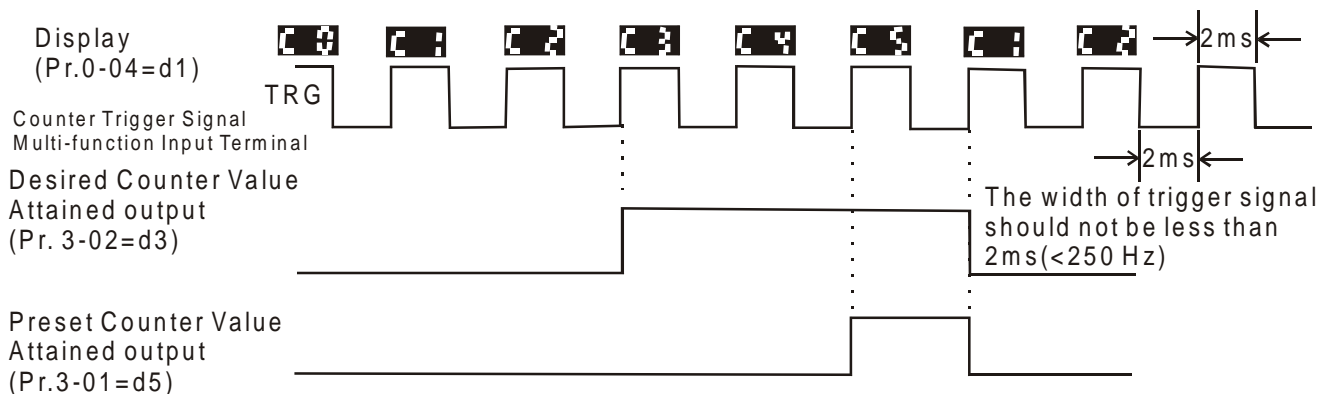

3 – 03

Multi-function
(relay output)

Factory Setting: d 8

Settings d 0 to d 16

Function Table List:

Setting	Function	Setting	Function
d 0	Not used	d 9	Desired Frequency Attained
d 1	AC Drive Operational	d 10	PLC Program Running
d 2	Maximum Output Frequency Attained	d 11	PLC Program Step Completed
d 3	Zero speed	d 12	PLC Program Completed
d 4	Over-Torque detection	d 13	PLC Operation Paused
d 5	Base-Block (B.B.) Indication	d 14	Terminal Count Value Attained
d 6	Low-Voltage Indication	d 15	Preliminary Counter Value Attained
d 7	AC Drive Operation Mode	d 16	Ready State Indicator
d 8	Fault Indication		



Function Explanations:

d 0 Not Used.

d 1 AC drive operational: the output of output terminal will be activated when there is an output from the drive.

d 2 Maximum Output Frequency Attained: the output will be activated when the AC drive attains Maximum Output Frequency.

- d 3 Zero speed:** the output will be activated when Command Frequency is lower than the Minimum Output Frequency.
- d 4 Over-Torque Detection:** the output will be activated as long as the over-torque is detected. Pr.6-04 determines the Over-Torque detection level.
- d 5 Base-Block (B.B.) Indication:** the output will be activated when the output of the AC drive is shut off by external Baseblock.
- d 6 Low Voltage Indication:** the output will be activated when low voltage is detected.
- d 7 AC Drive Operation Mode:** the output will be activated when the operation of the AC drive is controlled by External Control Terminals.
- d 8 Fault Indication:** the output will be activated when faults occur (oc, ov, oH, oL, oL1, EF, cF3, HPF, ocA, ocd, ocn, GF).
- d 9 Desired Frequency Attained:** the output will be activated when the desired frequency (Pr.3-02) is attained.
- d10 PLC Program Running:** the output will be activated when the PLC program is running.
- d11 PLC Program Step Completed:** the output will be activated for 0.5 sec. when each multi-step speed is attained.
- d12 PLC Program completed:** the output will be activated for 0.5 sec. when the PLC program cycle has completed.
- d13 PLC Program Operation Paused:** the output will be activated when PLC operation is paused.
- d14 Terminal Count Value Attained:** counter reaches Terminal Count Value.
- d15 Preliminary Count Value Attained:** counter reaches Preliminary Count Value.
- d16 Ready State Indicator**



Group 4: Input Function Parameters

4 - 00	Potentiometer Bias Frequency	Factory Setting: d0.0
	Settings d 0.0 to d 350Hz	Unit: 0.1Hz
	This parameter can be set during the operation.	
4 - 01	Potentiometer Bias Polarity	Factory Setting: d 0
	Settings d 0 Positive bias	
	d 1 Negative bias	
	This parameter can be set during the operation.	
4 - 02	Potentiometer Frequency Gain	Factory Setting: d 100
	Settings d 1 to d 200%	Unit: 1%
	This parameter can be set during the operation.	
4 - 03	Direction setting for negative bias	Factory Setting: d 0
	Settings d 0 Only receive positive bias	
	d 1 Negative bias with direction command. Positive bias means forward running and negative bias means reverse running.	
	d 2 Negative bias without direction command. Direction is controlled by keypad or external frequency command.	



Pr.4-00 to Pr.4-03 are used when the source of frequency command is the analog signal (0 to +10V DC or 4 to 20 mA DC). Refer to the following examples.

Example 1:

The following is the most common method. Set parameter 2-00 to d1 (0 to +10V signal), d2 (4 to 20mA current signal), or d3 (keypad potentiometer).

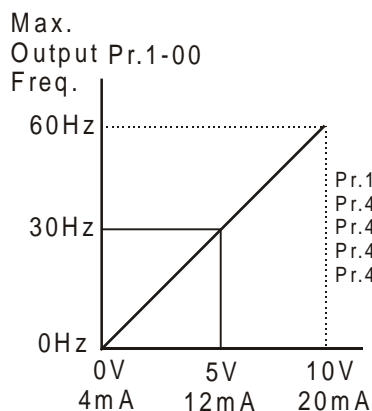

Factory Settings

Pr.1-00=60Hz--Max. output Freq.
 Pr.4-00=0Hz--Potentiometer bias freq.
 Pr.4-01=0 -- bias polarity
 Pr.4-02=100% -- pot. freq. gain
 Pr.4-03=0 -- pot. REV motion enable

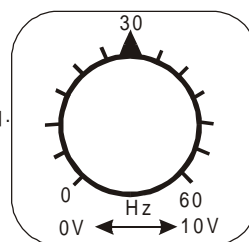

Potentiometer Scale

Example 2:

In this example with the potentiometer set to 0V the Output Frequency is 10 Hz. The mid-point of the potentiometer becomes 40 Hz. Once the Maximum Output Frequency is reached any further increase of the potentiometer will not increase output frequency.

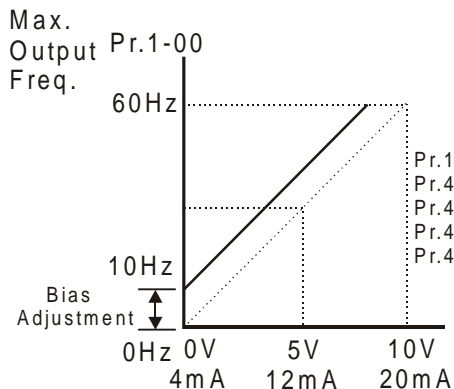

Parameter Settings

Pr.1-00=60Hz--Max. output Freq.
 Pr.4-00=10Hz--Potentiometer bias freq.
 Pr.4-01=0 -- bias polarity
 Pr.4-02=100% -- pot. freq. gain
 Pr.4-03=0 -- pot. REV motion enable

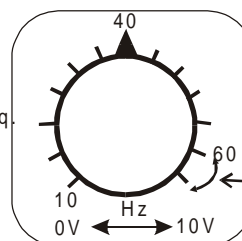

Potentiometer Scale

Example 3:

The example also shows the popular method. The whole scale of the potentiometer can be used as desired. In addition to signals of 0 to 10V and 4 to 20mA, the popular voltage signals also include signals of 0 to 5V, 20 to 4mA or that under 10V. Regarding the setting, please refer to the following examples.

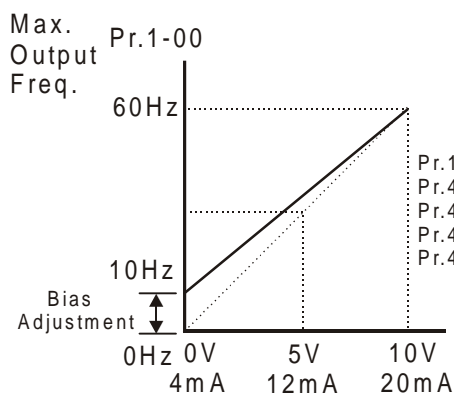

Parameter Settings

Pr.1-00=60Hz--Max. output Freq.
 Pr.4-00=10Hz--Potentiometer bias freq.
 Pr.4-01=0 -- bias polarity
 Pr.4-02=83% -- pot. freq. gain
 Pr.4-03=0 -- pot. REV motion enable

Calculation of gain

$$\text{Pr.4-02} = \left(1 - \frac{\text{Pr.4-00}}{\text{Pr.1-00}}\right) \times 100\%$$

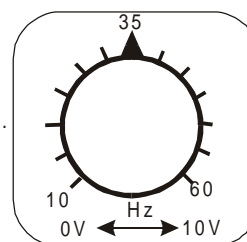

Potentiometer Scale



Example 4:

This example shows a potentiometer range of 0 to 5 Volts.

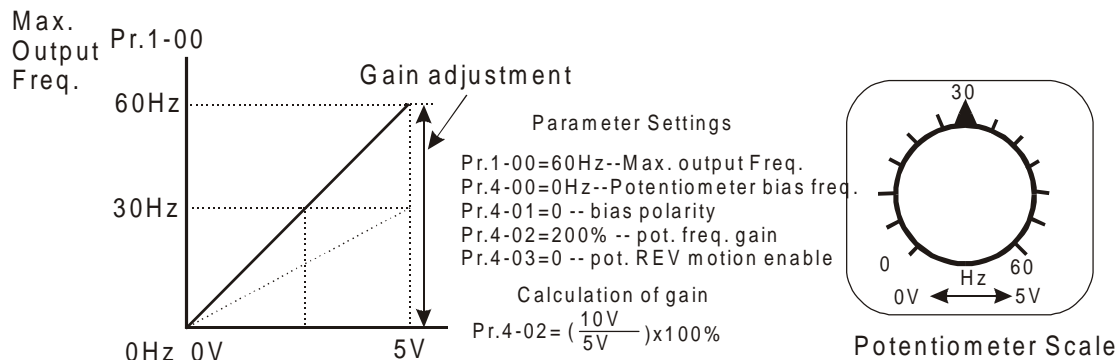

Example 5:

In this example a 1 volt negative bias is used. In a noise environment, it is advantageous to use negative bias to provide a noise margin (1V in this example).

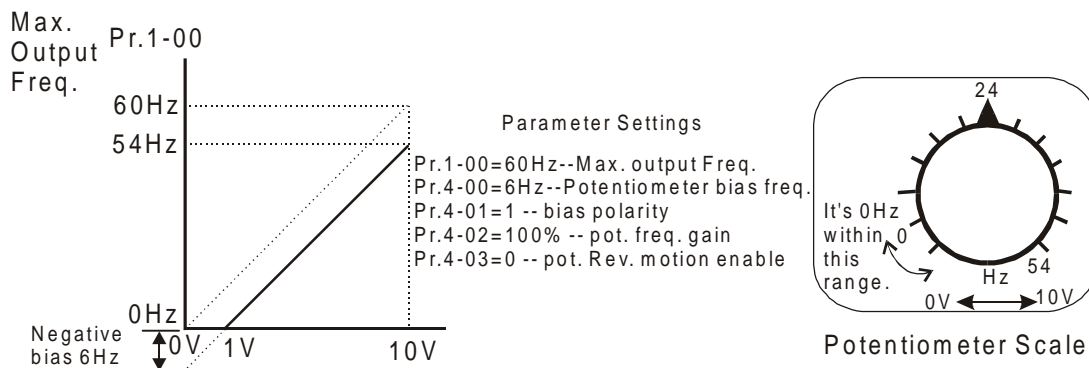

Example 6:

In this example, a negative bias is used to provide a noise margin. Also a potentiometer frequency gain is used to allow the Maximum Output Frequency to be reached.

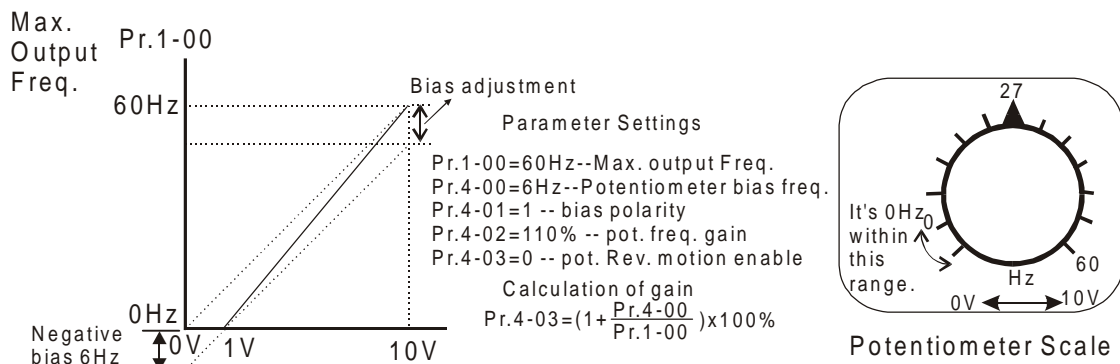

Example 7:

In this example, the potentiometer is programmed to run a motor in both forward and reverse direction. A motor will be idle when the potentiometer position is at mid-point of its scale. Using Pr.4-03 will disable the external FWD and REV controls.

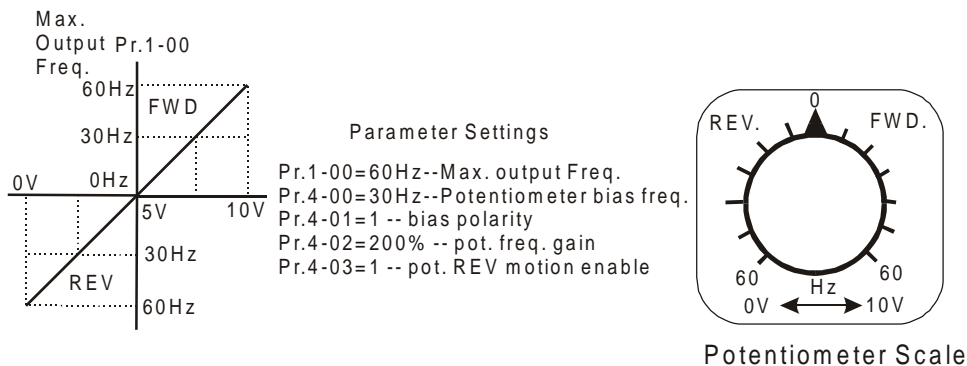

Example 8:

In this example, the option of anti-slope is shown. Anti-slope is used in an application where control of pressure, temperature, or flow is needed. Under a high pressure or flow situation, a sensor will generate a large signal such as 20 mA or 10V. With anti-slope enable, the large signal will slow or stop the AC drive.

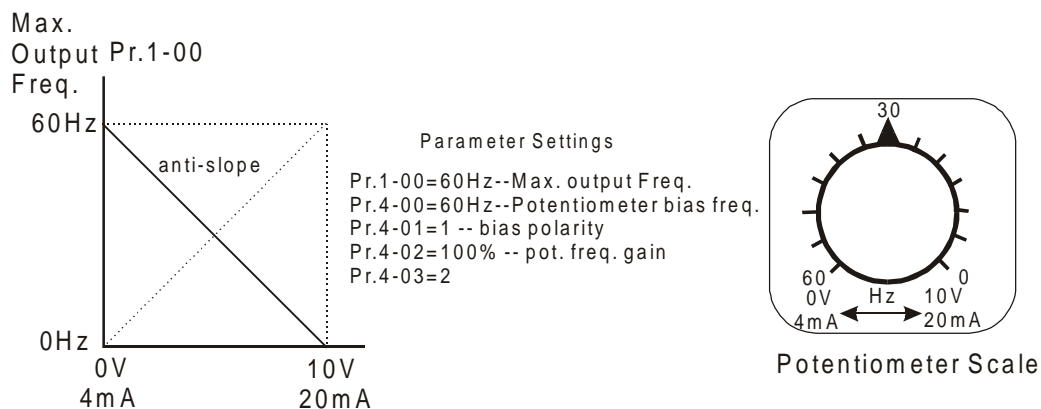

4 - 04

Multi-function Input Terminal (M0, M1)

Factory Setting: d 1

Settings d 0 to d 20

4 - 05

Multi-function Input Terminal (M2)

Factory Setting: d 6

4 - 06

Multi-function Input Terminal (M3)

Factory Setting: d 7

Settings d0, d 4 to d 20



Parameters & Functions table:

Value	Function	Value	Function
d 0	(input not used)	d11	First or Second Accel/Decel Time Selection
d 1	M0: FWD / STOP M1: REV / STOP	d12	External Base Block (N.O.) (Normally Open Contact Input)
d 2	M0: RUN / STOP M1: FWD / REV	d13	External Base Block (N.C.) (Normally Close Contact Input)
d 3	3-Wire Operation Control mode (M0,M1,M2)	d14	Increase Master Frequency
d 4	External Fault (Normally Open)	d15	Decrease Master Frequency
d 5	External Fault (Normally Closed)	d16	Run PLC Program
d 6	External Reset	d17	Pause PLC Program
d 7	Multi-Step Speed Command 1	d18	Counter Trigger Signal
d 8	Multi-Step Speed Command 2	d19	Counter Reset
d 9	Jog operation	d20	Select ACI/deselect AVI
d10	Accel/Decel Speed Inhibit		

Explanations:**d0 Parameter Disable:**

Enter value (d0) to disable any Multi-Function Input Terminal: M0, M1 (Pr.4-04), M2 (Pr.4-05) or M3 (Pr.4-06).

Note: The purpose of this function is to provide isolation for unused Multi-Function Input Terminals. Any unused terminals should be programmed to d0 to insure they have no effect on drive operation.

d1: Two wire operation: Restricted to Pr.4-04 and external terminals M0, M1.

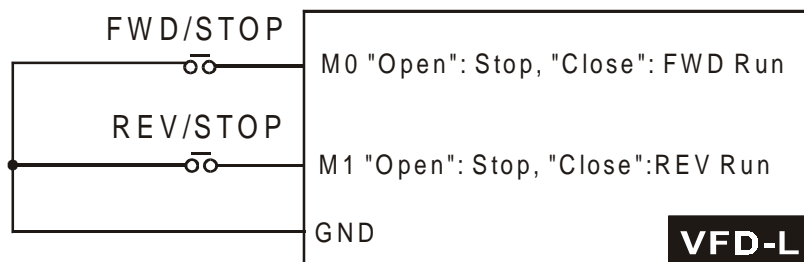

d2: Two wire operation: Restrict to Pr. 4-04 and external terminals M0, M1.

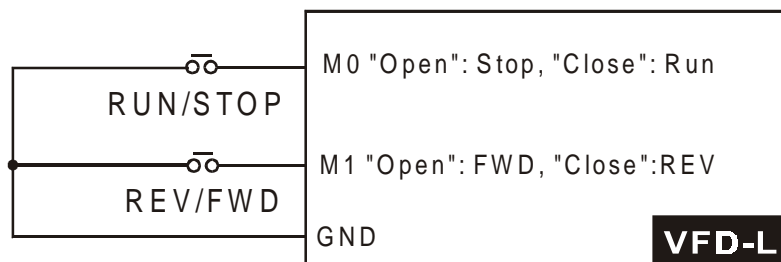

Note: Multi-function Input Terminal M0 does not have its own parameter designation. M0 must be used in conjunction with M1 to operate two and three wire control.

d3: Three Wire Control: Restricted to Pr.4-04 control terminals M0, M1, M2.

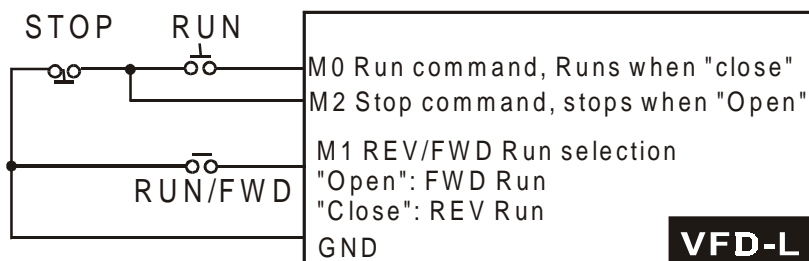

Note: When value d3 is selected for Pr. 4-04, this will over ride any value entered in Pr.4-05, since Pr.4-05 must be used for three wire control as shown above.

5

d4, d5 External Faults:

Parameter values d4, d5 programs Multi-Function Input Terminals: M1 (Pr.4-04), M2 (Pr.4-05) or M3 (Pr.4-06) to be External Fault (E.F.) inputs.

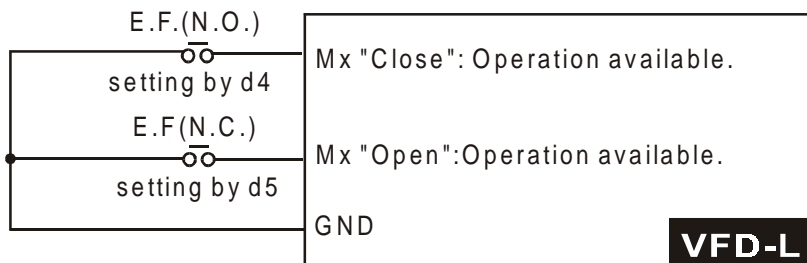

When an External Fault input signal is received, the AC drive will stop all output and display " E.F. " on Digital Keypad, the motor will free run. Normal operation can resume after the External Fault is cleared and the AC drive is reset.

d6 External Reset:

Parameter value d6 programs a Multi-Function Input Terminal: M1 (Pr.4-04), M2 (Pr.4-05) or M3 (Pr.4-06) to be an External Reset.

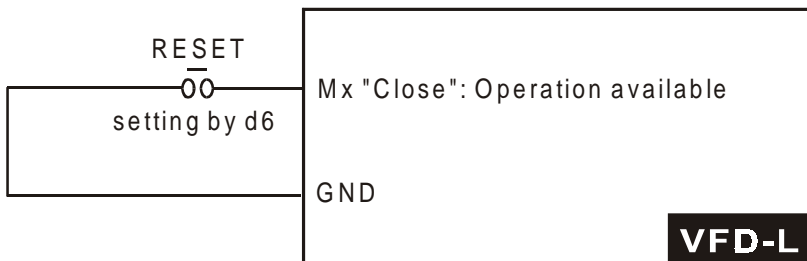



Note: the External Reset has the same function as the MODE/RESET key on the Digital keypad. After external fault such as O.H., O.C. and O.V. are clear, this input can be used to reset the drive.

d7, d8 Multi-Step Speed Command:

Parameter values d7, d8 programs any two of the following Multi-Function Input Terminals: M1 (Pr.4-04), M2 (Pr.4-05), or M3 (Pr.4-06) for multi-step speed command function.

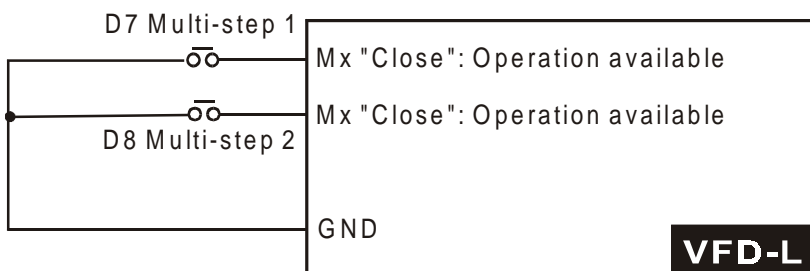

These three inputs select the multi-step speeds defined by Pr.5-00 to Pr.5-02 as shown in the following diagram. Pr.5-05 to Pr.5-8 can also control output timing by programming the AC drive's internal PLC function.

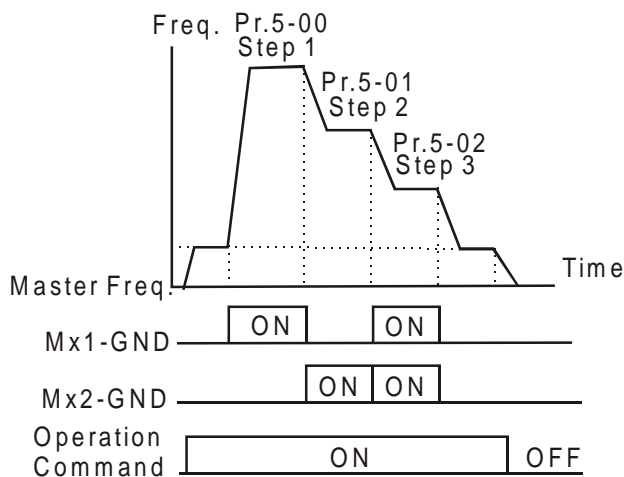

d9 Jog Operation Control:

Parameter value d9 programs Multi-Function Input Terminal: M1 (Pr.4-04), M2 (Pr.4-05) or M3 (Pr.4-06) for Jog control.

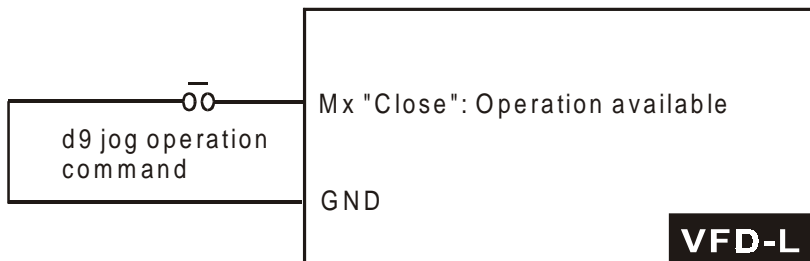

Note: Jog operation programmed by d9 can only be initiated while the motor is stopped.

(Refer to Pr.1-13, Pr.1-14.)

d10 Accel/Decel Speed Inhibit:

Parameter value d10 programs Multi-Function Input Terminal: M1 (Pr.4-04), M2 (Pr.4-05) or M3 (Pr.4-06) for Accel/Decel Inhibit. When the command is received, acceleration and deceleration is stopped and the AC drive maintains a constant speed.

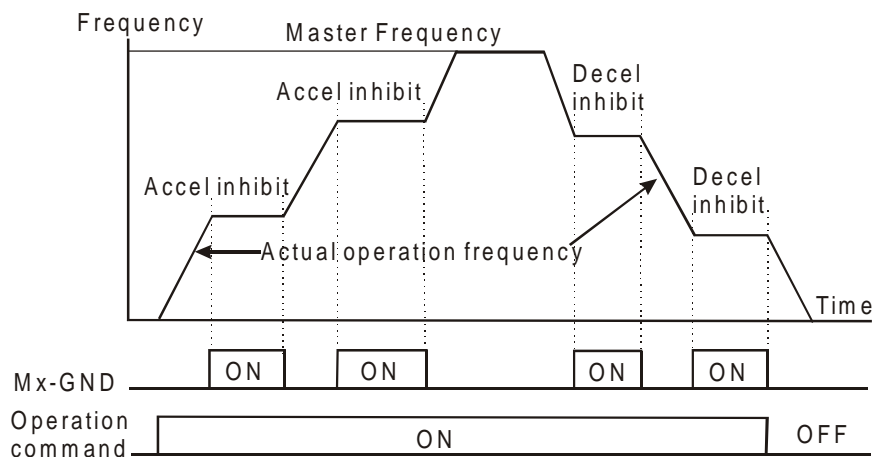

5

d11 First or Second Accel./Decel. Time Selection:

Parameter value d11 programs a Multi-Function Input Terminal: M1 (Pr.4-04), M2 (Pr.4-05) or M3 (Pr.4-06) to control selection of First or Second Accel/Decel time. (Refer to Pr.1-09 to Pr.1-12.)

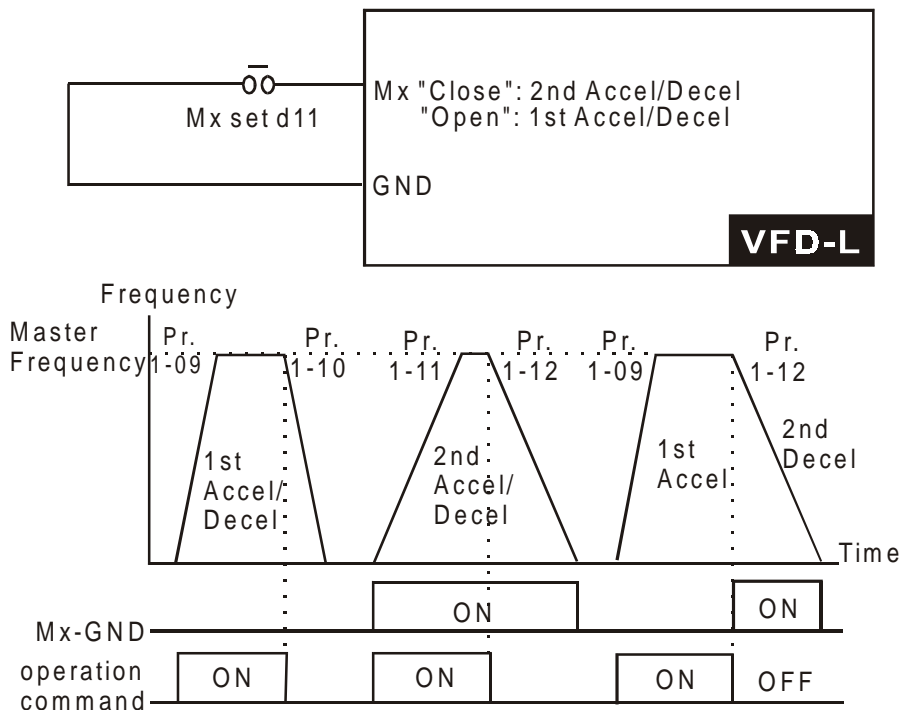



d12, d13 External Base Block:

Parameter values d12, d13 program Multi-Function Input Terminals: M1 (Pr.4-04), M2 (Pr.4-05) or M3 (Pr.4-06) for external Base Block control. Value d12 is for normally open (N.O.) input, and value d13 is for a normally closed (N.C.) input.

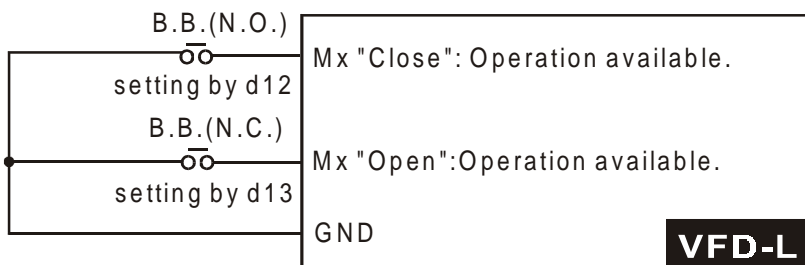

Note: When a Base-Block signal is received, the AC drive will stop all output and the motor will free run. When base block control is deactivated, the AC drive will start its speed search function and synchronize with the motor speed, and then accelerate to Master Frequency.

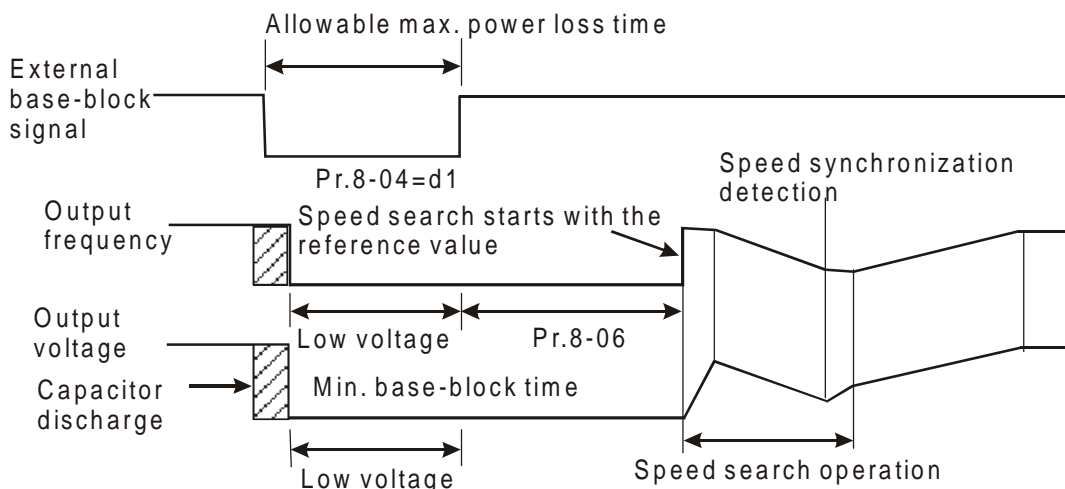

d14, d15 Increase/Decrease Master Frequency:

Parameter values d14, d15 program the Multi-Function Input Terminals: M1 (Pr.4-04), M2 (Pr.4-05) or M3 (Pr.4-06) to incrementally increase/ decrease the Master Frequency each time an input is received.

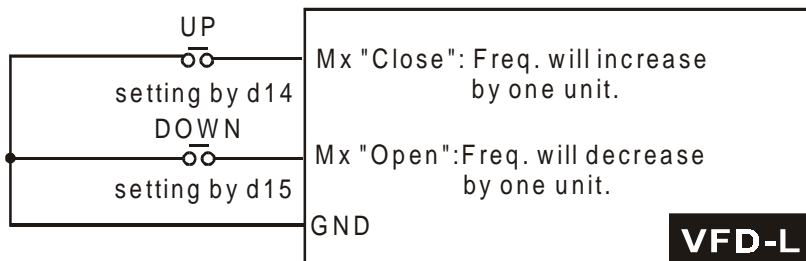

d16, d17 PLC Function Control:

Parameter value d16 programs Multi-Function Input Terminal: M1 (Pr.4-04), M2 (Pr.4-05) or M3 (Pr.4-06) to enable the AC drive internal PLC program. Parameter value d17 programs an input terminal to pause the PLC program.

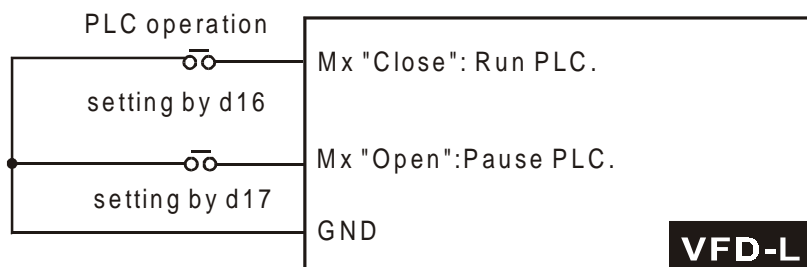

Note: Pr.5-00 to Pr.5-08 define the PLC program.

d18 Counter Trigger:

Parameter value d18 programs Multi-Function Input Terminal: M1 (Pr.4-04), M2 (Pr.4-05) or M3 (Pr.4-06) to increase the AC drive's internal counter. When an input is received, the counter is increased by 1.

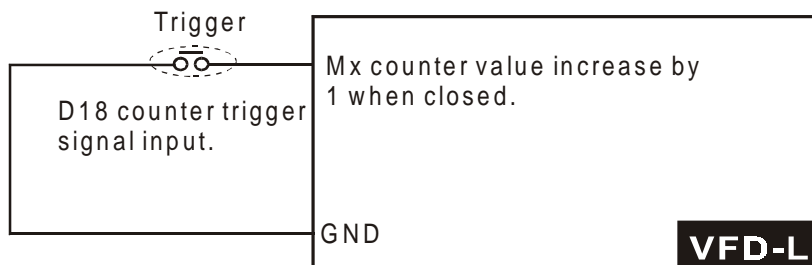

Note: The Counter Trigger input can be connected to an external Pulse Signal Generator to count a processing step or unit of material. See the diagram below.

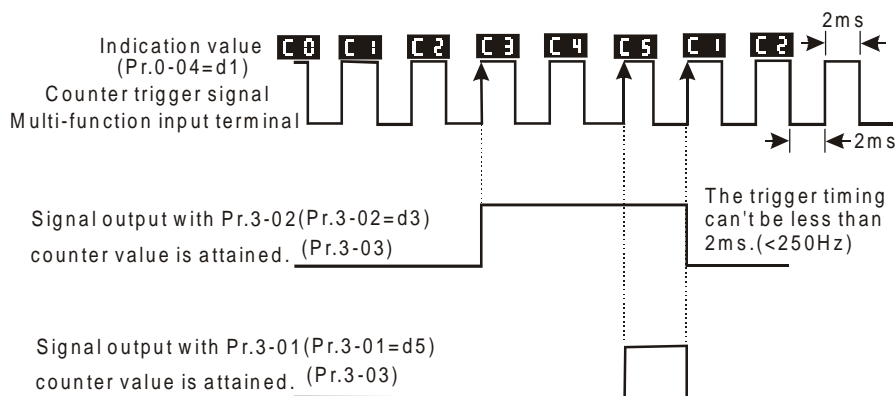



d19 Counter Reset:

Parameter value d19 programs Multi-Function Input Terminal: M1 (Pr.4-04), M2 (Pr.4-05) or M3 (Pr.4-06) to reset the counter.

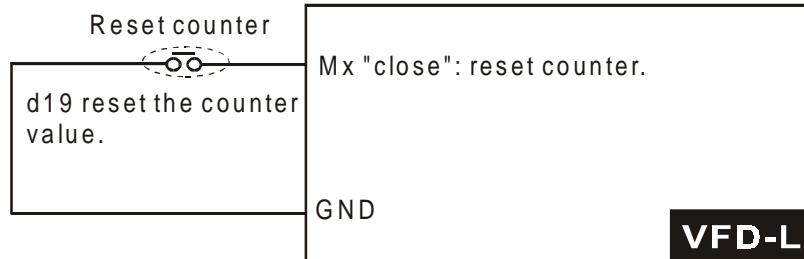

d20 Select ACI / Deselect AVI:

Parameter value d20 allows the user to select the input type ACI or AVI via an external switch. AVI is selected when the contact is open and ACI is selected when the contact is closed. Please note: the use of this feature will override Pr.2-00 programming and the jumper of the front of the drive must be moved to the correct location either across the AVI or ACI pin head.

Group 5: Multi-step Speed, Process Logic Control Parameters

5 - 00	1st Step Speed Frequency	Factory Setting: d 0.0
5 - 01	2nd Step Speed Frequency	Factory Setting: d 0.0
5 - 02	3rd Step Speed Frequency	Factory Setting: d 0.0

Settings d 0.0 to d 400 Hz Unit: 0.1Hz

This parameter can be set during operation.

 The Multi-Function Input Terminals (refer to Pr.4-04 to 4-06) are used to select one of the AC drive Multi-Step speeds. The speeds (frequencies) are determined by Pr.5-00 to 5-02 shown above.

5 - 03	PLC Mode	Factory Setting: d 0
	Settings	
	d 0	Disable PLC operation
	d 1	Execute one program cycle
	d 2	Continuously execute program cycles
	d 3	Execute one program cycle step by step
	d 4	Continuously execute program cycles step by step

5

 This parameter selects the mode of PLC operation for the AC drive. The PLC program can be used in lieu of any External Controls, Relays or Switches. The AC drive will change speeds and directions according to the user's desired programming.

Example 1 (Pr.5-03 = d1): Execute one cycle of the PLC program. Its relative parameter settings are:

1. Pr.5-00 to 5-02: 1st to 3rd step speed (sets the frequency of each step speed)
2. Pr.4-04 to 4-06: Multi-Function Input Terminals (set one multi-function terminal as d16-PLC auto-operation) .
3. Pr.3-03: Multi-Function Output (set the relay as d10-PLC operation indication, d11-one cycle in PLC auto mode or d12-PLC operation fulfillment attainment).
4. Pr.5-03: PLC mode.
5. Pr.5-04: Direction of operation for Master Frequency and 1st to 3rd step speed.
6. Pr.5-05 to 5-08: operation time setting of Master Frequency and 1st to 3rd step speed.

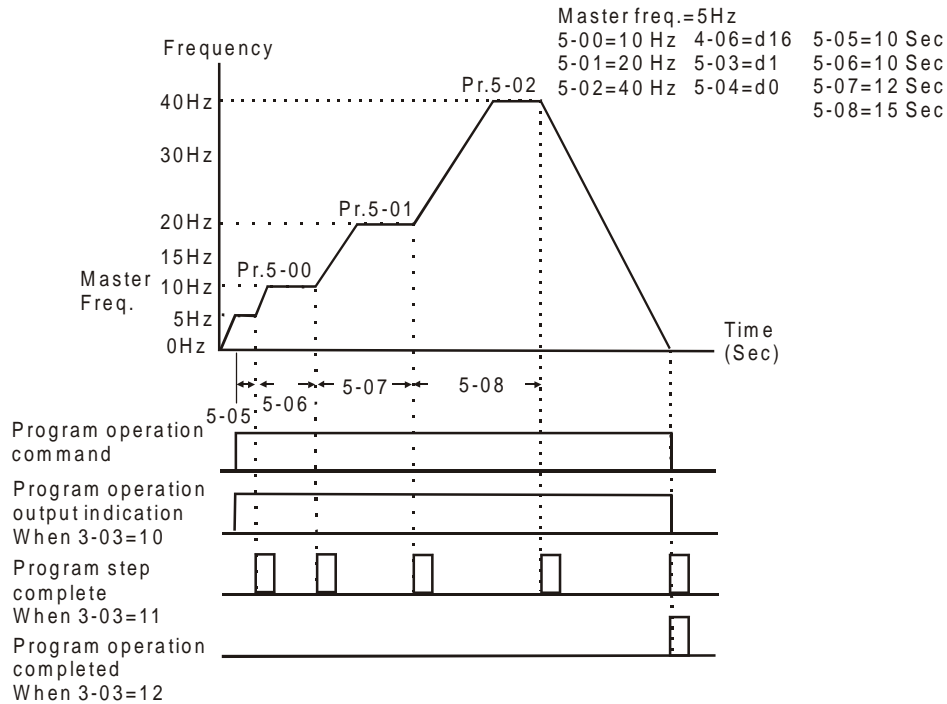

Note: The above diagram shows one complete PLC cycle. To restart the cycle, turn the PLC program off and then back on.

Example 2 (Pr.5-03 = d2): Continuously executes program cycles

The diagram below shows the PLC program stepping through each speed and the automatically starting again. To stop the PLC program, one must either pause the program or turn it off (Refer to Pr.4-05 to 4-06 value d16 and d17).

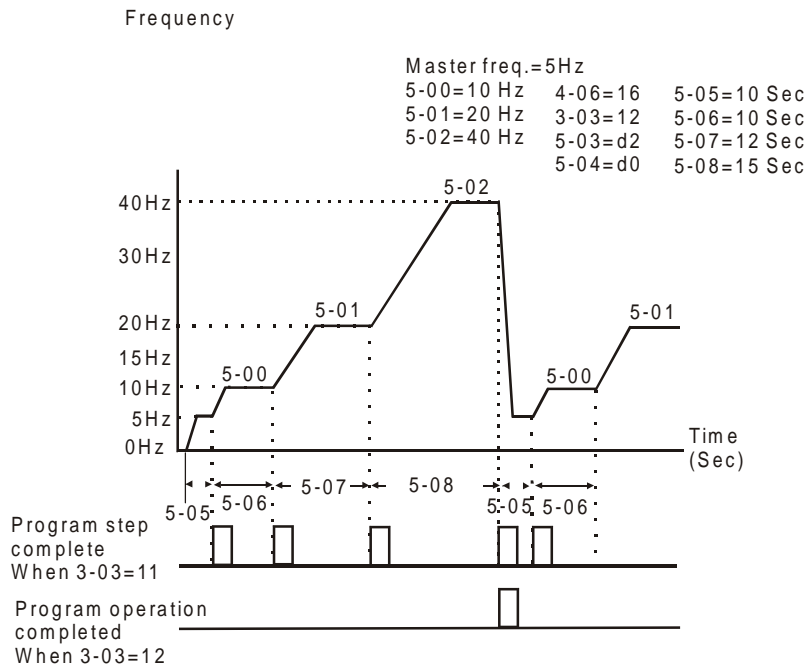

Example 3 (Pr. 5-03 = d3) Execute one cycle step by step:

The example shows how the PLC can perform one cycle at a time, within a complete cycle. Each step will use the accel/decel times in Pr.1-09 to Pr.1-12. It should be noticed that the time each step spends at its intended frequency is diminished, due to the time spent during accel/decel.

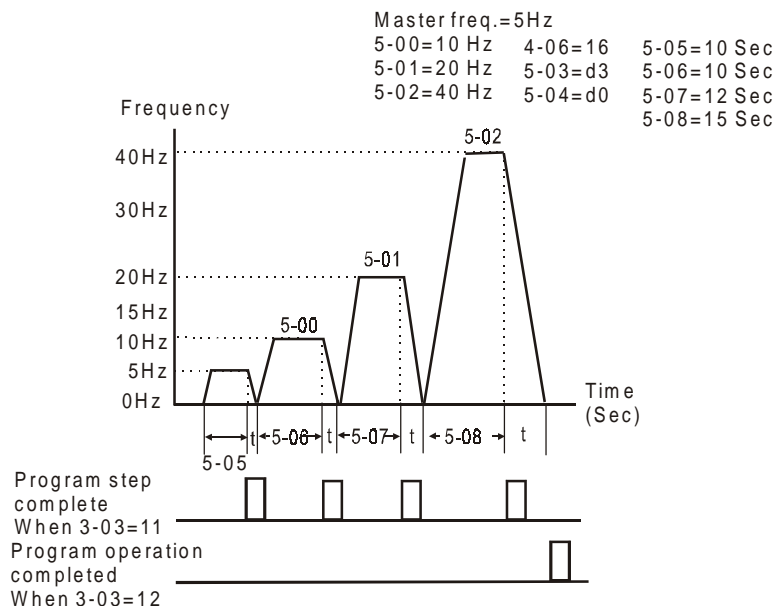

5

Example 4 (Pr. 5-03 =d 4) Continuously execute PLC cycles step by step:

In this explanation, the PLC program runs continuously step by step. Also shown are examples of steps in the Reverse direction.

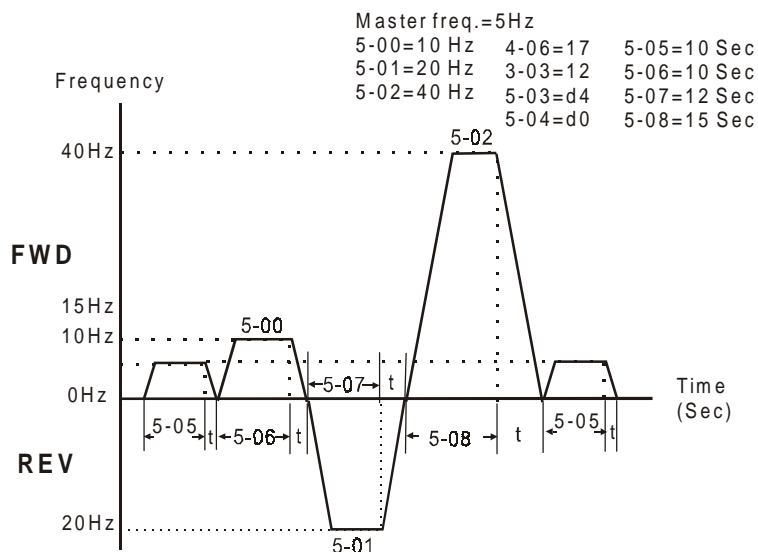

Settings d 0 to d 15



This parameter controls the direction of motion for the Multi-Step Speed Pr.5-00 to Pr.5-02 and the Master Frequency. The original direction of Master Frequency will become invalid. The equivalent 4-bit number is used to program the forward/reverse motion for each of the 4 speed steps (including Master Frequency). The binary notation for the 4-bit number must be translated into decimal notation and then be entered.

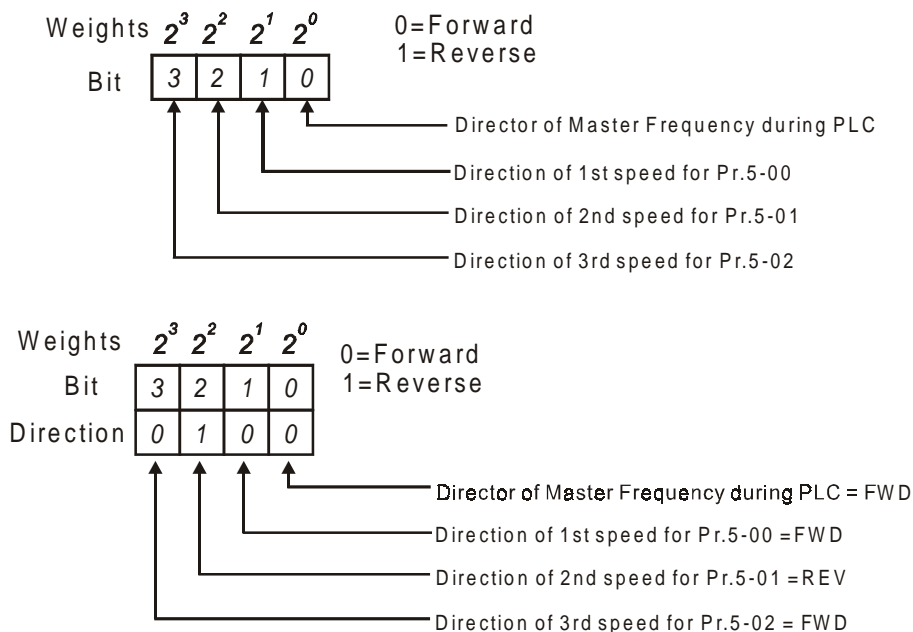

$$\begin{aligned}
 \text{The setting value} &= \text{bit3} \times 2^3 + \text{bit2} \times 2^2 + \text{bit1} \times 2^1 + \text{bit0} \times 2^0 \\
 &= 0 \times 2^3 + 1 \times 2^2 + 0 \times 2^1 + 0 \times 2^0 \\
 &= 0 + 4 + 0 + 0 \\
 &= 4 \qquad \qquad \qquad (\text{Set Pr.5-04 to d4})
 \end{aligned}$$



5 – 05	Time Duration Step 0	Factory Setting: d 0
5 – 06	Time Duration Step 1	Factory Setting: d 0
5 – 07	Time Duration Step 2	Factory Setting: d 0
5 – 08	Time Duration Step 3	Factory Setting: d 0
	Settings d 0 to d 65500	Unit: 1 sec

 Pr.5-05 to Pr.5-08 correspond to operation time of each multi-step speed defined by parameters 5-00 to 5-02. The maximum value of these parameters is 65500 sec., and it's displayed as d 65.5.

Note: If a parameter is set to “d0” (0 Sec), the corresponding step will be skipped. This is commonly used to reduce number of program steps



Group 6: Protection Parameters

6 - 00	Over-Voltage Prevention Level	Factory Setting: d 390
---------------	--------------------------------------	-------------------------------

Settings	d 0	Disable Over-Voltage Prevention
	d 350 to d 410	

Unit: 1 VAC

During deceleration, the motor DC bus voltage may exceed its Maximum Allowable Value due to motor regeneration. When this function is enabled, the AC drive will stop decelerating. Maintaining a constant output frequency when it happens. The AC drive will only resume deceleration when the voltage drops below preset value.

Note:

With a moderate inertial load, the over-voltage during deceleration won't happen, and the drive will stop in programmed time. The AC drive will automatically extend the deceleration time with high inertial loads. If deceleration time is critical for the application, then dynamic braking resistors should be used.

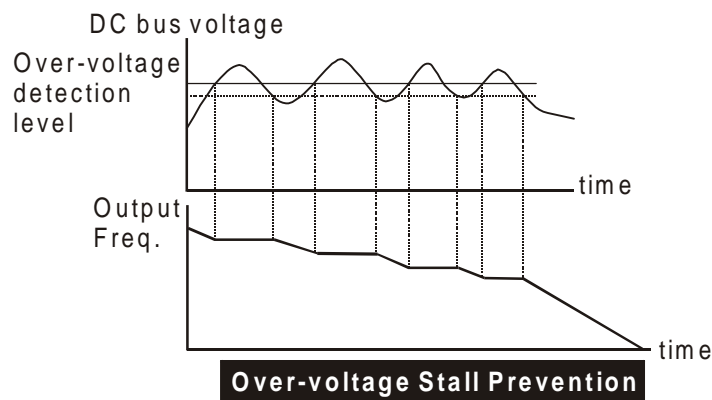

6 - 01	Over-Current Prevention Level	Factory Setting: d170
---------------	--------------------------------------	------------------------------

Settings	d 0	disable Over-Current Prevention
	d 20 to d 200%	

Unit: 1%

A setting of 100% is equal to the Rated Output Current of the drive.

During acceleration, the AC drive output current may increase abruptly to exceed the value specified by Pr.6-01 due to rapid acceleration or excessive load on the motor. When this function is enabled, the AC drive will stop accelerating and maintaining a constant output frequency. The AC drive will only resume acceleration when the current drops below the maximum value.

6 - 02	Over-Torque Detection Mode	Factory Setting: d 0
Settings	d 0	Over-Torque detection disabled.
	d 1	Over-Torque detection enabled during constant speed operation (OL2), and operation continues until the continuous operation limit (Pr.6-04) is reached.
	d 2	Over-Torque detection enabled during constant speed operation, and operation halted after over-torque detection.
	d 3	Over-Torque detection enabled during acceleration, and operation continues before the Continuous Output Time Limit (Pr.6-04) is reached.
	d 4	Over-Torque detection enabled during acceleration. Operation halted after over-torque detection

6 - 03	Over-Torque Detection Level	Factory Setting: d 150
Settings	d 30 to d 200%	Unit: 1%

 A setting of proportional to the Rated Output Current of the drive.

6 - 04	Continuous Output Time Limit	Factory Setting: d 0.1
Settings	d 0.1 to d 10.0 sec	Unit: 0.1sec

 This parameter determines the time that AC drive will run after over-torque is detected. Over-torque detection is based on the following:
If a Multi-Function Output Terminal is set as Over-Torque Detection Indication and the output current exceeds the Over-Torque Detection Level (Pr.6-04, Factory Setting: 150%), the output will be activated.

6 - 05	Electronic Thermal Overload Relay Selection	Factory Setting: d 0
Settings	d 0 Not used	
	d 1 Act with standard motor	
	d 2 Act with special motor	

 This function is used to limit the output power of the AC drive when powering a “self-cooled motor” at low speed.

**6 – 06****Electronic Thermal Characteristic**

Factory Setting: d 60

Settings d 30 to d 600Sec

Unit: 1 Sec

This parameter can be set during operation.



The parameter determines the time required activating the I^2t electronic thermal protection function. The graph below shows I^2t curves for 150% output power for 1 minute.

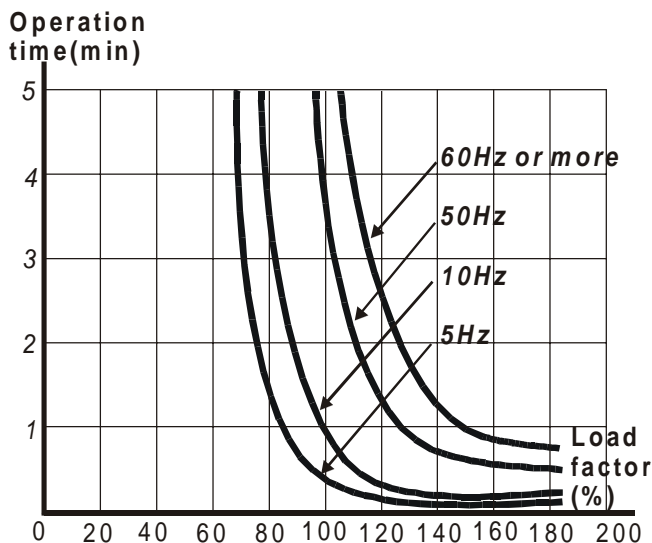

6 – 07	Present Fault Record	Factory Setting: d 0
6 – 08	Second Most Recent Fault Record	Factory Setting: d 0
6 – 09	Third Most Recent Fault Record	Factory Setting: d 0
6 – 10	Forth Most Recent Fault Record	Factory Setting: d 0
6 – 11	Fifth Most Recent Fault Record	Factory Setting: d 0
6 – 12	Sixth Most Recent Fault Record	Factory Setting: d 0

Settings	d 0	No fault occurred
	d 1	Over-current (oc)
	d 2	Over-voltage (ov)
	d 3	Overheat (oH)
	d 4	Overload (oL)
	d 5	Overload1 (oL1)
	d 6	External fault (EF)
	d 7	CPU failure (cF3)
	d 8	Hardware protection failure (HPF)
	d 9	Current exceeds 2 times rated current during acce. (ocA)
	d 10	Current exceeds 2 times rated current during dece. (ocd)
	d 11	Current exceeds 2 times rated current during steady state operation (ocn)



Pr.6-07 to 6-12 store records of the six most recent faults that had occurred. Use the MODE/RESET key to reset the drive when the fault no longer exists.

Group 7: Motor Parameters

7 - 00 Motor Rated Current Factory Setting: d 85

Settings d 30 to d 120% Unit: 1%

This parameter can be set during operation.

 This parameter will limit the AC drive output current in order to prevent the motor from overheating.

7 - 01 Motor No-load Current Factory Setting: d 50

Settings d 0 to d 90% Unit: 1%

This parameter can be set during operation.

 The rated current of the AC drive is regarded as 100%. Motor setting of no-load current will effect the slip compensation. The setting value must be less than motor rated current setting Pr.7-00

5

7 - 02 Torque Compensation Factory Setting: d 1

Settings d 0 to d 10 Unit: 1

This parameter can be set during operation.

 This parameter may be set so that the AC drive will increase its voltage output during start-up to obtain a higher initial starting torque.

7 - 03 Slip Compensation Factory Setting: d 0.0

Settings d 0.0 to d 10.0 Unit: 0.1

This parameter can be set during operation.

 When powering an asynchronous motor, the load on the AC drive will increase causing an increase in slip. This parameter may be used to compensate the nominal slip within a range of 0 to 10. When the output current of the AC drive is greater than the motor no-load current (Pr.7-01), the AC drive will adjust its output frequency according to this parameter.



Group 8: Special Parameters

8 - 00 DC Braking Voltage Level Factory Setting: d 0

Settings d 0 \leftrightarrow d30% Unit: 1%

- This parameter determines the level of DC Braking Voltage Level output to the motor during start-up and stopping. When setting DC Braking Voltage, the Maximum Output Voltage (Pr.1-02) is regarded as 100%. It is recommended to start with a low DC Braking Voltage Level and then increase until proper holding torque has been attained.

8 - 01 DC Braking Time during Start-up Factory Setting: d 0.0

Settings d 0.0 to d 60.0 sec Unit: 0.1sec

- This parameter determines the duration of time that the DC Braking Current will be applied to the motor during the AC drive start-up. DC Braking will be applied for the time set in this parameter until the Minimum Frequency is reached during acceleration.

8 - 02 DC Braking Time during Stopping Factory Setting: d 0.0

Settings d 0.0 to d 60.0 sec Unit: 0.1 sec

- This parameter determines the duration of time that the DC braking voltage will be applied to the motor during stopping. If stopping with DC Braking is desired, then Pr.2-02 must be set to RAMP stop (d 0).

8 - 03 Start-Point for DC Braking Factory Setting: d 0.0

Settings d 0.0 to d 400Hz Unit: 0.1Hz

- This parameter determines the frequency when DC Braking will begin during deceleration.

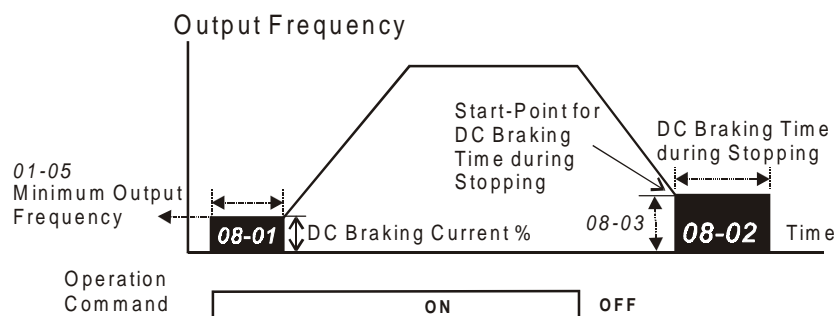

- NOTE: 1.** DC Braking during Start-up is used for loads that may move before AC drive starts, such as fans and pumps. These loads may also be moving in the wrong direction. Under such circumstances, DC Braking can be executed to hold the load in position before applying a forward motion.

2. DC Braking during stopping is used to decrease stopping time and also to hold a stopped load in position. For high inertial loads, a dynamic braking resistor may be needed for quick decelerations.

8 - 04	Momentary Power Loss Operation Selection	Factory Setting: d 0
---------------	---	-----------------------------

- | | | |
|----------|-----|--|
| Settings | d 0 | Operation stopped after momentary power loss |
| | d 1 | Operation continues after momentary power loss
Speed search start with the Master Frequency reference value |
| | d 2 | Operation continues after momentary power loss
Speed search starts with the min frequency |

8 - 05	Maximum Allowable Power Loss Time	Factory Setting: d 2.0
---------------	--	-------------------------------

Settings	d 0.3 to d 5.0Sec	Unit: 0.1Sec
----------	-------------------	--------------

-  During a power loss, if the power loss time is less than the time defined by this parameter, the AC drive will resume operation. If the Maximum Allowable Power Loss Time is exceeded, the AC drive output is then turned off.

8 - 06	Base-Block Time for Speed Search	Factory Setting: d 0.5
---------------	---	-------------------------------

Settings	d 0.3 to d 5.0Sec	Unit: 0.1Sec
----------	-------------------	--------------

-  When a momentary power loss is detected, the AC drive turns off for a specified time interval determined by Pr.8-06 before resuming operation. This time interval is called Base-Block. This parameter should be set to a value where the residual output voltage is nearly zero, before the drive resumes operation.

-  This parameter also determines the searching time when performing external Base-Block and fault reset.

8 - 07	Maximum Speed Search Current Level	Factory Setting: d 150
---------------	---	-------------------------------

Settings	d 30 to d 200%	Unit: 1%
----------	----------------	----------

-  Following a power failure, the AC drive will start its speed search operation, only if the output current is greater than the value determined by Pr.8-07. When the output current is less than that of Pr.8-07, the AC drive output frequency is at a “speed synchronization point”. The drive will start to accelerate or decelerate back to the operating frequency at which it was running prior to the power failure.

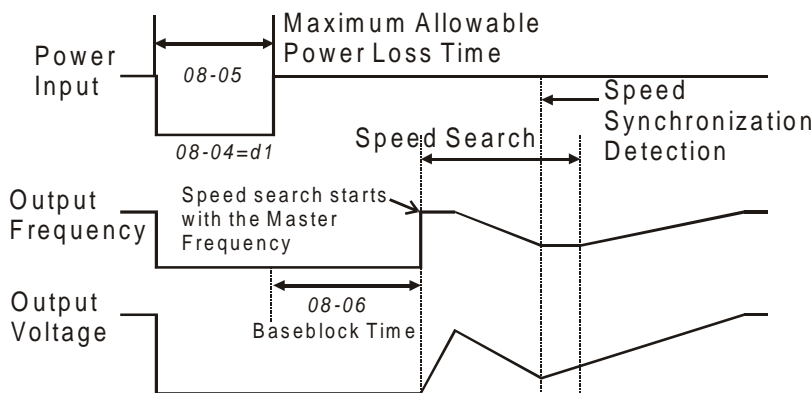

8 - 08	Skip Frequency 1 Upper Bound	Factory Setting: d 0.0
8 - 09	Skip Frequency 1 Lower Bound	Factory Setting: d 0.0
8 - 10	Skip Frequency 2 Upper Bound	Factory Setting: d 0.0
8 - 11	Skip Frequency 2 Lower Bound	Factory Setting: d 0.0
8 - 12	Skip Frequency 3 Upper Bound	Factory Setting: d 0.0
8 - 13	Skip Frequency 3 Lower Bound	Factory Setting: d 0.0

Settings d 0.0 \leftrightarrow d 400Hz

Unit: 0.1Hz

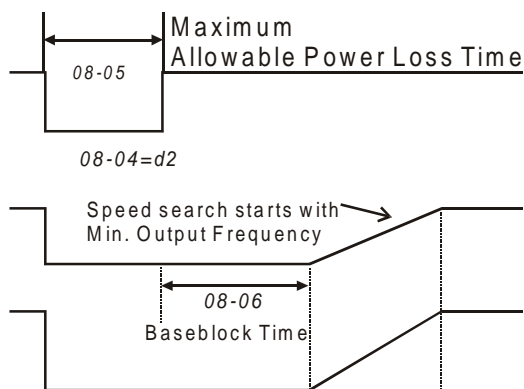

These parameters determine Skip frequency. It will cause the AC drive to skip operation at these frequency ranges with continuous frequency output.

Pr.8-9, Pr.8-11, Pr.8-13 are for Lower Bound setting, and the settings should follow as $Pr.8-9 \geq Pr.8-11 \geq Pr.8-13$.

8 - 14	Auto Restart After Fault	Factory Setting: d 0
---------------	--------------------------	----------------------

Settings d 0 to d 10

After fault occurs (allowable faults: over-current OC, over-voltage OV), the AC drive can be reset/restarted automatically up to 10 times. Setting this parameter to 0 will disable the reset/restart operation after any fault has occurred. When enabled, the AC drive will restart with speed search, which starts at the Master Frequency.



8 - 15	Automatic Voltage Regulation (AVR)	Factory Setting: d 2
---------------	---	-----------------------------

- | | | |
|----------|-----|---|
| Settings | d 0 | AVR function enabled |
| | d 1 | AVR function disabled |
| | d 2 | AVR function disabled when deceleration |

 AVR function automatically regulates the AC drive output voltage to the Maximum Output Voltage (Pr.1-02). For instance, if Pr.1-02 is set at 200 VAC and the input voltage is at 200V to 264VAC, then the Maximum Output Voltage will automatically be regarded to 200 VAC.

 Without AVR function, the Maximum Output Voltage may vary between 180V to 264VAC, due to the input voltage varying between 180V to 264 VAC.

 Selecting program value d2 enables the AVR function and also disables the AVR function during deceleration. This offers a quicker deceleration.

5

8 - 16	Dynamic Braking Voltage	Factory Setting: d 380*
---------------	--------------------------------	--------------------------------

- | | | |
|----------|------------------|--------------|
| Settings | d 350 to d 450V* | Unit: 1Volt* |
|----------|------------------|--------------|

 During deceleration, the DC-bus voltage will increase due to motor regeneration. When DC bus voltage level exceeds the Dynamic Braking Voltage, the DC brake output pins (B1, B2) will be activated.

8 - 17	DC Braking Lower Bound Limit	Factory Setting: d 0.0
---------------	-------------------------------------	-------------------------------

- | | | |
|----------|-----------------|-------------|
| Settings | d0.0 to d400 Hz | Unit: 0.1Hz |
|----------|-----------------|-------------|

 The setting frequency is lower than Pr.8-17, the DC Braking will not be activated when stops.



Group 9: Communication Parameters

9 - 00 Communication Address Factory Setting: d 1

Settings d 1 to 247

This parameter can be set during operation.

 If the AC drive is controlled by RS-485 serial communication, the communication address must be set via this parameter.

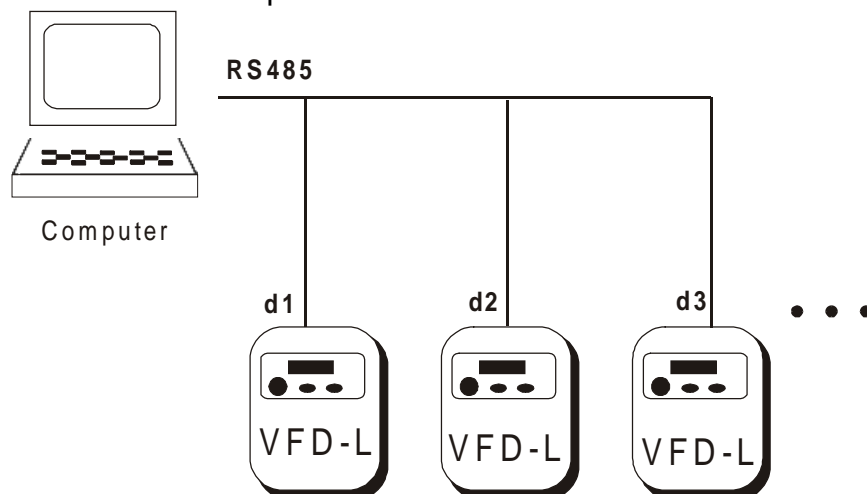

9 - 01 Transmission Speed Factory Setting: d 1

Settings d 0 Baud rate 4800 (data transmission speed: bits / second)
 d 1 Baud rate 9600 (data transmission speed: bits / second)
 d 2 Baud rate 19200 (data transmission speed: bits / second)

This parameter can be set during operation.

 Users can set parameters and control the operation of the AC drive via the RS-485 serial interface of a personal computer. This parameter is used to set the transmission speed between the computer and AC drive.

9 - 02 Transmission Fault Treatment Factory Setting: d 0

Settings d 0 Warn and keep operating
 d 1 Warn and RAMP to stop
 d 2 Warn and COAST to stop
 d 3 No Warning and keep operating

9 - 03	Modbus Communication Watchdog Timer	Factory Setting: d 0
Settings	d0 Disable	Unit: 1 sec
	d1 to d20 1 to 20 sec	

This parameter can be set during operation.

-  If the Watchdog timer function is enabled, the timer will start counting once the first valid Modbus communication signal is received after power-up or reset. The timer will reset to 0 after each valid Modbus communication message is received. If the watchdog timer reaches the value set in Pr. 9-03, the drive will stop its output and display the message "CE10" on the digital keypad. This fault can reset by an external terminal, keypad or a Modbus communication reset command.

9 - 04	Communication Protocol	Factory Setting: d 0
Settings	d 0 Modbus ASCII mode, protocol <7,N,2>	
	d 1 Modbus ASCII mode, protocol <7,E,1>	
	d 2 Modbus ASCII mode, protocol <7,O,1>	
	d 3 Modbus ASCII mode, protocol <8,N,2>	
	d 4 Modbus ASCII mode, protocol <8,E,1>	
	d 5 Modbus ASCII mode, protocol <8,O,1>	
	d 6 Modbus RTU mode, protocol <8,N,2>	
	d 7 Modbus RTU mode, protocol <8,E,1>	
	d 8 Modbus RTU mode, protocol <8,O,1>	

This parameter can be set during operation.

1.Computer Control

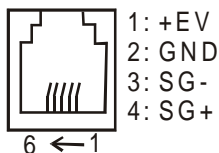

- ★ There is a built-in RS-485 serial interface, marked (RJ-11 Jack) on the control terminal block, for VFD Series. The pins are defined below:
Each VFD-L AC drive has a pre-assigned communication address specified by Pr. (9-00). The computer then controls each AC drive according to its communication address.



- ★ VFD-L can be setup to communicate on Modbus networks using one of the following modes: ASCII (American Standard Code for Information Interchange) or RTU (Remote Terminal Unit). Users can select the desired mode along with the serial port communication protocol in Pr. 9-04.

- ★ Code Meaning:

ASCII mode:

Each 8-bit data is the combination of two ASCII characters. For example, a 1-byte data: 64 Hex, shown as '64' in ASCII, consists of '6' (36Hex) and '4' (34Hex).

Character	'0'	'1'	'2'	'3'	'4'	'5'	'6'	'7'
ASCII code	30H	31H	32H	33H	34H	35H	36H	37H

Character	'8'	'9'	'A'	'B'	'C'	'D'	'E'	'F'
ASCII code	38H	39H	41H	42H	43H	44H	45H	46H

RTU mode:

Each 8-bit data is the combination of two 4-bit hexadecimal characters. For example, 64 Hex.

2.Data Format:

2.1 10-bit character frame (For 7-bit character):

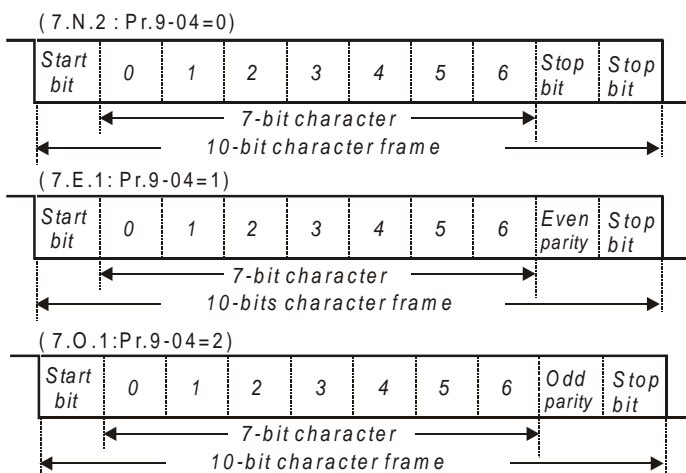

2.2 11-bit character frame (For 8-bit character):

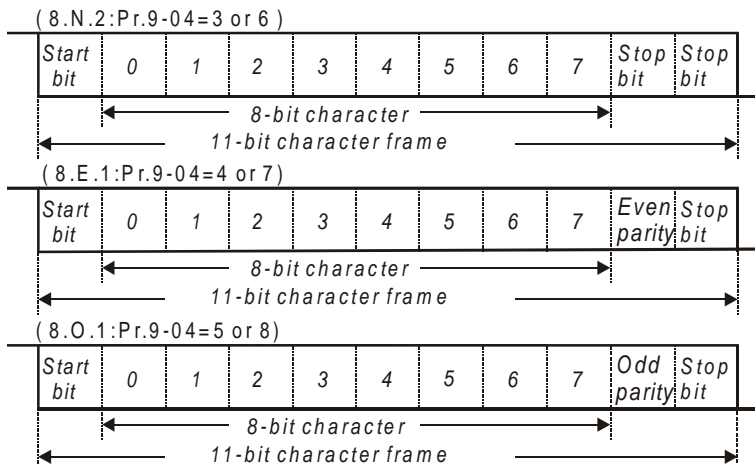

3. Communication Protocol

3.1 Communication Data Frame:

ASCII mode:

STX	Start character ':' (3AH)
ADR 1	Communication address: 8-bit address consists of 2 ASCII codes
ADR 0	
CMD 1	Command code: 8-bit command consists of 2 ASCII codes
CMD 0	
DATA (n-1)	Contents of data: $n \times 8$ -bit data consist of $2n$ ASCII codes. $n \leq 25$, maximum of 50 ASCII codes
.....	
DATA 0	
LRC CHK 1	LRC check sum: 8-bit check sum consists of 2 ASCII codes
LRC CHK 0	
END 1	End characters: END1= CR (0DH), END0= LF(0AH)
END 0	

RTU mode:

START	A silent interval of more than 10 ms
ADR	Communication address: 8-bit address
CMD	Command code: 8-bit command
DATA (n-1)	Contents of data: $n \times 8$ -bit data, $n \leq 25$
.....	
DATA 0	
CRC CHK Low	CRC check sum: 16-bit check sum consists of 2 8-bit characters
CRC CHK High	
END	A silent interval of more than 10 ms



3.2 ADR (Communication Address)

Valid communication addresses are in the range of 0 to 254. Communication address equals to 0 means broadcast to all AC drives (AMD), in this case, the AMD will not reply any message to the master device.

For example, communication to AMD with address 16 decimal:

ASCII mode: (ADR 1, ADR 0)='1','0' => '1'=31H, '0'=30H

RTU mode: (ADR)=10H

3.3 CMD (Command code) and DATA (data characters)

The format of data characters depends on the command code. The available command codes are described as followed: Command code: 03H, read N words. The maximum value of N is 12. For example, reading continuous 2 words from starting address 2102H of AMD with address 01H.

ASCII mode:

Command message:

STX	'.'
ADR 1	'0'
ADR 0	'1'
CMD 1	'0'
CMD 0	'3'
Starting data address	'2'
	'1'
	'0'
	'2'
Number of data (count by word)	'0'
	'0'
	'0'
	'2'
LRC CHK 1	'D'
LRC CHK 0	'7'
END 1	CR
END 0	LF

Response message:

STX	'.'
ADR 1	'0'
ADR 0	'1'
CMD 1	'0'
CMD 0	'3'
Number of data (count by byte)	'0'
	'4'
	'1'
	'7'
Content of starting data address 2102H	'7'
	'7'
	'0'
	'0'
Content of data address 2103H	'0'
	'0'
	'0'
	'0'
LRC CHK 1	'7'
LRC CHK 0	'1'
END 1	CR
END 0	LF

RTU mode:

Command message:

ADR	01H
CMD	03H
Starting data address	21H
	02H
Number of data (count by word)	00H
	02H
CRC CHK Low	6FH
CRC CHK High	F7H

Response message:

ADR	01H
CMD	03H
Number of data (count by byte)	04H
Content of data address 2102H	17H
	70H
Content of data address 2103H	00H
	00H
CRC CHK Low	FEH
CRC CHK High	5CH

Command code: 06H, write 1 word

For example, writing 6000(1770H) to address 0100H of AMD with address 01H.

5

ASCII mode:

Command message:

STX	‘:’
ADR 1	‘0’
ADR 0	‘1’
CMD 1	‘0’
CMD 0	‘6’
Data dress	‘0’
	‘1’
	‘0’
	‘0’
	‘1’
	‘7’
	‘7’
	‘0’
LRC CHK 1	‘7’
LRC CHK 0	‘1’
END 1	CR
END 0	LF

Response message:

STX	‘:’
ADR 1	‘0’
ADR 0	‘1’
CMD 1	‘0’
CMD 0	‘6’
Data address	‘0’
	‘1’
	‘0’
	‘0’
Data content	‘1’
	‘7’
	‘7’
	‘0’
LRC CHK 1	‘7’
LRC CHK 0	‘1’
END 1	CR
END 0	LF

**RTU mode:**

Command message:

ADR	01H
CMD	06H
Data address	01H 00H
Data content	17H 70H
CRC CHK Low	86H
CRC CHK High	22H

Response message:

ADR	01H
CMD	06H
Data address	01H 00H
Data content	17H 70H
CRC CHK Low	86H
CRC CHK High	22H

3.4 CHK (check sum)

ASCII mode:

LRC (Longitudinal Redundancy Check) is calculated by summing up, module 256, the values of the bytes from ADR1 to last data character then calculating the hexadecimal representation of the 2's-complement negation of the sum.

For example, reading 1 word from address 0401H of the AC drive with address 01H

STX	':'
ADR 1	'0'
ADR 0	'1'
CMD 1	'0'
CMD 0	'3'
Starting data address	'0' '4' '0' '1'
Number of data	'0' '0' '0' '1'
LRC CHK 1	'F'
LRC CHK 0	'6'
END 1	CR
END 0	LF

$01H+03H+04H+01H+00H+01H=0AH$, the 2's-complement negation of 0AH is **F6H**.

RTU mode:

ADR	01H
CMD	03H
Starting address	21H 02H
Number of data (count by word)	00H 02H
CRC CHK Low	6FH
CRC CHK High	F7H

CRC (Cyclical Redundancy Check) is calculated by the following steps:

- Step 1: Load a 16-bit register (called CRC register) with FFFFH.
- Step 2: Exclusive OR the first 8-bit byte of the command message with the low order byte of the 16-bit CRC register, putting the result in the CRC register.
- Step 3: Shift the CRC register one bit to the right with MSB zero filling. Extract and examine the LSB.
- Step 4: If the LSB of CRC register is 0, repeat step 3, else Exclusive or the CRC register with the polynomial value A001H.
- Step 5: Repeat step 3 and 4 until eight shifts have been performed. When this is done, a complete 8-bit byte will have been processed.
- Step 6: Repeat steps 2 to 5 for the next 8-bit byte of the command message. Continue doing this until all bytes have been processed. The final contents of the CRC register are the CRC value. **When transmitting the CRC value in the message, the upper and lower bytes of the CRC value must be swapped, i.e. the lower order byte will be transmitted first.**

The following is an example of CRC generation using C language. The function takes two arguments:

Unsigned char* data ← a pointer to the message buffer

Unsigned char length ← the quantity of bytes in the message buffer

The function returns the CRC value as a type of unsigned integer.

```

Unsigned int crc_chk(unsigned char* data, unsigned char length){
    int j;
    unsigned int reg_crc=0xFFFF;
    while(length--){
        reg_crc ^= *data++;
        for(j=0;j<8;j++){
            if(reg_crc & 0x01){ /* LSB(b0)=1 */
                reg_crc=(reg_crc>>1) ^ 0xA001;
            }else{
                reg_crc=reg_crc >>1;
            }
        }
    }
    return reg_crc;
}

```



3.5 Address list:

The contents of available addresses are shown as below:

Content	Address	Functions	
AC drive Parameters	ggnnH	gg means parameter group, nn means parameter number, for example, the address of Pr 4-01 is 0401H. Referencing to chapter 5 for the function of each parameter. When reading parameter by command code 03H, only one parameter can be read at one time.	
Command	2000H	Bit 0-1	00: No function 01: Stop 10: Run 11: Jog + Run
		Bit 2-3	Not used
		Bit 4-5	00: No function 01: FWD 10: REV 11: Change direction
		Bit 6-15	Not used
	2001H	Freq. command	
	2002H	Bit 0	1: EF (external fault) on
		Bit 1	1: Reset
		Bit 2-15	Not used
Status monitor Read only	2100H	Error code: 0: No errors occurred 1: Over-current (oc) 2: Over-voltage (ov) 3: Overheat (oH) 5: Overload1 (oL1) 6: External fault (EF) 7: CPU failure (cF3) 8: Hardware protection failure (HPF) 9: Current exceeds 2 times rated current during accel (ocA) 10: Current exceeds 2 times rated current during decel (ocd)	



Content	Address	Functions	
Status monitor Read only	2100H	11: Current exceeds 2 times rated current during steady state operation (ocn) 12: Reserved 13: Reserved 14: Low voltage (Lv) 15: CPU failure 1 (cF1) 16: CPU failure 2 (cF2) 17: Base block 18: Overload (oL2) 19: Auto accel/decel failure (cFA) 20: Software protection enable (codE)	
	2101H	Status of AC Drive	
Bit 0-1		00: RUN LED light off, STOP LED light up 01: RUN LED blink, STOP LED light up 10: RUN LED light up, STOP LED blink 11: RUN LED light up, STOP LED light off	
		Bit 2	01: Jog active
		Bit 3-4	00: REV LED light off, FWD LED light up 01: REV LED blink, FWD LED light up 10: REV LED light up, FWD LED blink 11: REV LED light up, FRD LED light off
			Bit 5-7
Bit 8			1: Main freq. Controlled by communication
Bit 9			1: Main freq. Controlled by external terminal
Bit 10		1: Operation command controlled by communication	
Bit 11		1: Parameters have been locked	
Bit 12-15		Not Used	
2102H		Frequency command F (XXX.XX)	
2103H		Output Frequency H (XXX.XX)	
2104H		Output Current A (XXX.XX)	
2105H	DC-BUS Voltage U (XXX.XX)		
2106H	Output Voltage E (XXX.XX)		
2107H	Step number of Multi-Step Speed Operation		
2108H	Step number of PLC operation		
2109H	Time of PLC Operation		
210AH	Counter Value		



3.6 Exception response:

Except for broadcast messages, the AC drive is been expected to return a normal response after receiving command messages from the master device. The following depicts the conditions that no normal response is replied to the master device.

The AC drive does not receive the messages due to a communication error; thus, the AC drive has no response. The master device will eventually process a timeout condition.

The AC drive receives the messages without a communication error, but cannot handle it, an exception response will return to the master device and an error message “CExx” will display on the keypad of AC drive. The xx of “CExx” is a decimal code equal to the exception code that will describe below.

In the exception response, the most significant bit of the original command code is set to 1, and an exception code explains the condition that caused the exception is returned. An example of exception response of command

code 06H and exception code 02H:

ASCII mode:

STX	‘:’
ADR 1	‘0’
ADR 0	‘1’
CMD 1	‘8’
CMD 0	‘6’
Exception code	‘0’
	‘2’
LRC CHK 1	‘7’
LRC CHK 0	‘7’
END 1	CR
END 0	LF

RTU mode:

ADR	01H
CMD	86H
Exception code	02H
CRC CHK Low	C3H
CRC CHK High	A1H

The meaning of exception code:

The AC drive receives the messages, but detects a communication error, thus, no response is returned, but there will be error message “CExx” displayed on the keypad of AC drive. The master device will eventually process a timeout condition. The xx of “CExx” is a decimal code, the meaning of the error message is below:



Error message	Meaning
1	Illegal command code: The command code received in the command message is not available for the AC drive.
2	Illegal data address: The data address received in the command message is not available for the AC drive.
3	Illegal data value: The data value received in the command message is not available for the AC drive.
4	Slave device failure: The AC drive is unable to perform the requested action.
5	Reserved
6	AC drive busy: The time interval between commands is too short. Please keep an interval of 10ms at least after the return of a command. If no command returned, please keep a 10ms interval at least for the same reason.
7	Reserved
8	Reserved
9	Check Sum Error Check if the Check Sum is correct.
10	Watchdog Timer The timer will reset to 0 after each valid Modbus communication message is received.
11	Frame Error: Check if the Baud rate comply with the data format.
12	The command message is too short.
13	Command message length is out of range.
14	The command messages include the data that does not belong to '0' to '9', 'A' to 'F' except starting and end character (only for Modbus ASCII mode).



3.7 Communication program of PC:

The following is a simple example of how to write a communication program for Modbus ASCII mode on a PC by C language.

```
#include<stdio.h>
#include<dos.h>
#include<conio.h>
#include<process.h>

#define PORT 0x03F8 /* the address of COM1 */

/* the address offset value relative to COM1 */
#define THR 0x0000
#define RDR 0x0000
#define BRDL 0x0000
#define IER 0x0001
#define BRDH 0x0001
#define LCR 0x0003
#define MCR 0x0004
#define LSR 0x0005
#define MSR 0x0006

unsigned char rdat[60];
/* read 2 data from address 2102H of AC drive with address 1 */
unsigned char tdat[60]={':', '0', '1', '0', '3', '2', '1', '0', '2',
                      '0', '0', '0', '2', 'D', '7', '\r', '\n'};

void main(){
    int i;
    outportb(PORT+MCR,0x08);          /* interrupt enable */
    outportb(PORT+IER,0x01);         /* interrupt as data in */
    outportb(PORT+LCR,(inportb(PORT+LCR) | 0x80));
    /* the BRDL/BRDH can be access as LCR.b7==1 */
    outportb(PORT+BRDL,12);          /* set baudrate=9600,
12=115200/9600*/
    outportb(PORT+BRDH,0x00);
    outportb(PORT+LCR,0x06);         /* set protocol, <7,N,2>=06H
```

```
<7,E,1>=1AH, <7,O,1>=0AH
<8,N,2>=07H, <8,E,1>=1BH
<8,O,1>=0BH */
for(i=0;i<=16;i++){
    while(!(inportb(PORT+LSR) & 0x20)); /* wait until THR empty */
    outportb(PORT+THR,tdat[i]); /* send data to THR */
}

i=0;
while(!kbhit()){
    if(inportb(PORT+LSR) & 0x01){ /* b0==1, read data ready */
        rdat[i++]=inportb(PORT+RDR); /* read data form RDR */
    }
}
}
```

CHAPTER 6 MAINTENANCE AND INSPECTIONS

Modern AC drives are based on solid state electronics technology, preventive maintenance is required to operate this AC drive in its optimal condition, and to ensure a long life. It is recommended to perform a monthly check up of the AC drive by a qualified technician. Before the check up, always turn off the AC Input Power to the unit. ***Wait at least 2 minutes after all display lamps have gone out.***

6.1 Periodic Inspection:

Basic check up items to detect if there were any abnormality during the operation:

1. Whether the motors are operating as expected.
2. Whether the installation environment is abnormal.
3. Whether the cooling system is operating as expected.
4. Whether any irregular vibration or sound occurred during the operation.
5. Whether the motors are overheated during the operation.
6. Always check the input voltage of the AC drive with Voltmeter.

6.2 Periodic Maintenance



WARNING! Disconnecting AC power before processing!

1. Tighten and reinforce the screws of the AC drive if necessary, cause it may loose due to the vibration or changing of temperatures.
2. Whether the conductors or insulators were corroded and damaged.
3. Check the resistance of the insulation with Mega-ohmmeter.
4. Often check and change the capacitors and relays.
5. If use of the AC drive is discontinued for a long period of time, turn the power on at least once every two years and confirm that it still functions properly. To confirm functionality, disconnect the motor and energize the AC drive for 5 hours or more before attempting to run a motor with it.
6. Clean off any dust and dirt with a vacuum cleaner. Place special emphasis on cleaning the ventilation ports and PCBs. Always keep these areas clean, as accumulation of dust and dirt can cause unforeseen failures.

CHAPTER 7 Troubleshooting and Fault Information

The VFD-L AC drive has a comprehensive fault diagnostic system that includes several different alarms and fault messages. Once a fault is detected, the corresponding protective functions will be activated. The following faults are displayed on the AC drive digital keypad. The six most recent faults can be read on the digital keypad display by viewing Pr.6-07 to Pr.6-12.

NOTE: Faults can be cleared by a reset from the keypad or Input Terminal.

Common Problems and Solutions:

Fault Name	Fault Descriptions	Corrective Actions
OC	The AC drive detects an abnormal increase in current.	<ol style="list-style-type: none"> 1. Check whether the motors horsepower corresponds to the AC drive output power. 2. Check the wiring connections between the AC drive and motor for possible short circuits. 3. Increase the Acceleration time. 4. Check for possible excessive loading conditions at the motor. 5. If there are any abnormal conditions when operating the AC drive after short-circuit being removed, it should be sent back to manufacturer.
OU	The AC drive detects that the DC bus voltage has exceeded its maximum allowable value.	<ol style="list-style-type: none"> 1. Check whether the input voltage falls within the rated AC drive input voltage. 2. Check for possible voltage transients. 3. Bus over-voltage may also be caused by motor regeneration. Either increase the decel time or add an optional braking resistor. 4. Check whether the required braking power is within the specified limits.



Fault Name	Fault Descriptions	Corrective Actions
OH	The AC drive temperature sensor detects excessive heat.	<ol style="list-style-type: none"> 1. Ensure that the ambient temperature falls within the specified temperature range. 2. Make sure that the ventilation holes are not obstructed. 3. Remove any foreign objects on the heatsinks and check for possible dirty heat sink fins. 4. Provide enough spacing for adequate ventilation.
LU	The AC drive detects that the DC bus voltage has fallen below its minimum value.	Check whether the input voltage falls within the rated AC drive's input voltage.
OL	The AC drive detects excessive drive output current.	<ol style="list-style-type: none"> 1. Check whether the motor is overloaded. 2. Reduce torque compensation setting as set in Pr.7-02. 3. Increase the AC drive's output capacity. 4. Note: The AC drive can withstand up to 150% of the rated current for a maximum of 60 seconds.
OL1	Internal electronic overload trip	<ol style="list-style-type: none"> 1. Check for possible motor overload. 2. Check electronic thermal overload setting. 3. Increase motor capacity. 4. Reduce the current level so that the drive output current does not exceed the value set by the Motor Rated Current Pr.7-00.
OL2	Motor overload. Check the parameter settings (Pr.6-03 to Pr.6-05)	<ol style="list-style-type: none"> 1. Reduce the motor load. 2. Adjust the over-torque detection setting to an appropriate setting (Pr.06-03 to Pr.06-05).
CE1	Communication Error	<ol style="list-style-type: none"> 1. Check the connection between the AC drive and computer for loose wires. 2. Check if the communication protocol is properly set.



Fault Name	Fault Descriptions	Corrective Actions
ocA	Over-current during acceleration: 1. Short-circuit at motor output. 2. Torque boost too high. 3. Acceleration time too short. 4. AC drive output capacity is too small.	1. Check for possible poor insulation at the output line. 2. Decrease the torque boost setting in Pr.7-02. 3. Increase the acceleration time. 4. Replace the AC drive with one that has a higher output capacity (next HP size).
ocd	Over-current during deceleration: 1. Short-circuit at motor output. 2. Deceleration time too short. 3. AC drive output capacity is too small.	1. Check for possible poor insulation at the output line. 2. Increase the deceleration time. 3. Replace with the AC drive with one that has a higher output capacity (next HP size).
ocn	Over-current during steady state operation: 1. Short-circuit at motor output. 2. Sudden increase in motor loading. 3. AC drive output capacity is too small.	1. Check for possible poor insulation at the output line. 2. Check for possible motor stall. 3. Replace the AC drive with one that has a higher output capacity (next HP size).
EF	The external terminal EF-GND goes from OFF to ON.	1. When external terminal EF-GND is closed, the output will be turned off. (Under N.O. E.F.) 2. Press RESET after fault has been cleared.
cf1	Internal memory IC can not be programmed.	1. Return to the factory. 2. Check the EEPROM on the control board.



Fault Name	Fault Descriptions	Corrective Actions
cF2	Internal memory IC can not be read.	<ol style="list-style-type: none"> 1. Return to the factory. 2. Reset drive to factory defaults.
cF3	Drive's internal circuitry abnormal.	Return to the factory.
HPF	Hardware protection failure	Return to the factory.
codeE	Software protection failure	Return to the factory.
cFA	Auto accel/decel failure	Don't use the function of auto acceleration /deceleration.
bb	External Base Block. AC drive output is turned off.	<ol style="list-style-type: none"> 1. When the external input terminal (B.B) is active, the AC drive output will be turned off. 2. Disable this connection and the AC drive will begin to work again.



CHAPTER 8 SUMMARY OF PARAMETER SETTINGS

Group 0: User Parameters

⚡The parameter may be set during operation.

Parameters	Functions	Settings	Factory Setting
0-00	Identity code of drive (Read only)	1: 40W 2: 100W 3: 200W 4: 400W 5: 750W 6: 1.5KW	
0-01	Rated current display (Read only)	40W: 0.4A 100W: 0.8A 200W: 1.6A 400W: 2.5A 750W: 4.2A 1.5K: 7.0A	
0-02	Parameter reset	10: Reset Parameters to Factory Setting	0
⚡ 0-03	Start-up display of AC drive	0: F (Frequency command) 1: H (output frequency) 2: U (user-defined unit) 3: A (output current)	0
⚡ 0-04	User-defined Unit	0: Display User-Defined Unit (u) 1: Display Counter Value (C) 2: Display Process Operation (1=tt) 3: Display DC-BUS voltage (U) 4: Display output voltage (E)	0
⚡ 0-05	User-defined coefficient K	0.1 ~ 160	1.0
0-06	Software version	Read only	#.#
0-07	Password input	0 ~ 999	0
0-08	Password configuration	0 ~ 999	0

Group 1: Basic Parameters

Parameters	Functions	Settings	Factory Setting
1-00	Maximum operation Freq.	50.0 ~ 400Hz	60.0
1-01	Maximum setting Freq.	10.0 ~ 400Hz	60.0
1-02	Maximum output voltage	2.0 ~ 255V	220
1-03	Mid-point freq.	1.0 ~ 400Hz	1.0
1-04	Mid-point voltage	2.0 ~ 255V	12.0
1-05	Minimum output freq.	1.0 ~ 60.0Hz	1.0



	Parameters	Functions	Settings	Factory Setting
	1-06	Minimum output voltage	2.0 ~ 255V	12.0
	1-07	Upper bound of freq.	1 ~ 110%	100
	1-08	Lower bound of freq.	0 ~ 100%	0.0
↗	1-09	Accel time 1 (Tacc1)	0.1 ~ 600 Sec	10.0
↗	1-10	Decel time 1 (Tdec1)	0.1 ~ 600 Sec	10.0
↗	1-11	Accel time 2	0.1 ~ 600 Sec	10.0
↗	1-12	Decel time 2	0.1 ~ 600 Sec	10.0
↗	1-13	JOG Accel time	0.1 ~ 600 Sec	10.0
↗	1-14	JOG Decel time	0.0 ~ 600 Sec	10.0
↗	1-15	JOG frequency	1.0Hz~400Hz	6.0
	1-16	Auto-accel/decel	0: Linear Accel/Decel 1: Auto accel, linear decel 2: Linear accel, auto decel, 3: Auto Accel/Decel 4: Linear accel. Auto decel, stall prevention during deceleration 5: Auto accel. Linear decel, stall prevention during deceleration	0
	1-17	S-curve setting in acceleration	0 ~ 7	0
	1-18	S-curve setting in deceleration	0 ~ 7	0

Group 2: Operation Method Parameters

	Parameters	Functions	Settings	Factory Setting
	2-00	Source of frequency command	0: Digital keypad 1: 0 ~ 10V from AVI 2: 4 ~ 20mA from AVI 3: Controlled by V.R on drive 4: RS-485 communication interface	0
	2-01	Source of operation command	0: By digital keypad 1: By external terminals, keypad STOP enable 2: By external terminals, keypad STOP disable 3: By RS-485 communication interface, keypad STOP enable 4: By RS-485 communication interface, keypad STOP disable	0
	2-02	Stop method	0: Ramp stop 1: Coast stop	0
	2-03	Carrier freq.	3 ~10K Hz	10



2-04	Reverse operation inhibit	0: Enable reverse 1: Disable reverse 2: Disable forward	0
2-05	ACI (4 ~ 20mA) input loss detection	0: Accel to 0Hz 1: Stop immediately, display EF 2: Run with the last freq.	0
2-06	Line Start Lockout	0: Enable 1: Disable	0

Group 3: Output Function Parameters

Parameters	Functions	Settings	Factory Setting
3-00	Desired freq. attained	1.0 ~ 400 Hz	1.0
3-01	Terminal count value	0 ~ 999	0
3-02	Preliminary count value	0 ~ 999	0
3-03	Multi-function (relay output)	0: not used 1: AC drive operational 2: Max. Output Freq. Attained 3: Zero Speed 4: Over Torque 5: Base-Block (B.B.) 6: Low Voltage Detection 7: AC Drive Operation Mode 8: Fault Indication 9: Desired Freq. Attained 10: PLC Program Running 11: PLC Program Step Complete 12: PLC Program Complete 13: PLC Program Operation Pause 14: Terminal Count Value Attained 15: Preliminary Count Value Attained 16: Ready State Indicator	8

8

Group 4: Input Function Parameters

Parameters	Functions	Settings	Factory setting
⚡ 4-00	Potentiometer bias freq.	0.0 ~ 350Hz	0.0
⚡ 4-01	Potentiometer bias polarity	0: positive bias 1: negative bias	0
⚡ 4-02	Potentiometer freq. gain	1 ~ 200%	100
4-03	Potentiometer reverse motion enable	0: not used 1: reverse motion enable 2: forward motion only	0



Parameters	Functions	Settings	Factory setting
4-04	Multi-function input terminal1 (M0, M1) (d 0~d 20)	0: not used 1: M0: FWD/STOP, M1:REV/STOP 2: M0: FWD/REV, M1:RUN/STOP 3: M0, M1, M2: 3-wire operation control mode 4: External fault, normally open (N.O.) 5: External fault, normally closed (N.C.) 6: RESET 7: multi-step speed command 1 8: multi-step speed command 2 9: jog operation 10: accel/decel speed inhibit 11: first or second accel/decel time selection 12: base-block (B.B.),normally open (N.O.) 13: base-block (B.B.),normally closed (N.C) 14: increase master freq. 15: decrease master freq. 16: run PLC program 17: pause PLC 18: counter trigger signal 19: counter reset 20: select ACI/deselect AVI	1
4-05	Multi-function input terminal 2(M2)		6
4-06	Multi-function input terminal 3(M3) (d 0, d 4~d 20)		7

Group 5: Multi-step Speed and PLC Parameters

Parameters	Functions	Settings	Factory Setting
5-00	1 st step speed freq.	0.0 ~ 400Hz	0.0
5-01	2 nd step speed freq.	0.0 ~ 400Hz	0.0
5-02	3 rd step speed freq.	0.0 ~ 400Hz	0.0
5-03	PLC mode	0: Disable PLC operation 1: Execute one program cycle 2: Continuously execute program cycles 3: Execute one program cycle step by step (separate by STOP) 4: Continuously execute one program cycle step by step (separate by STOP)	0
5-04	PLC forward/reverse motion	0 ~ 15 (0: Forward 1: Reverse)	0
5-05	Time duration step 0	0 ~ 65500 Sec	0
5-06	Time duration step 1	0 ~ 65500 Sec	0
5-07	Time duration step 2	0 ~ 65500 Sec	0
5-08	Time duration step 3	0 ~ 65500 Sec	0



Group 6: Protection Parameters

Parameters	Functions	Settings	Factory Setting
6-00	Over-Voltage Prevention Level	0:disable 350~410V	390
6-01	Over-current Prevention Level	0: disable 20~200%	170
6-02	Over-torque detection	0:disable 1:enable during constant speed operation and continues until the continuous limit is reached. 2:enabled during constant speed operation and halted after detection. 3:enabled during accel and continues before continuous output time limit is reached. 4:enabled during accel and halted after over-torque detection.	0
6-03	Over-torque detection level	30 ~ 200%	150
6-04	Over-torque detection time	0.1 ~ 10.0 Sec	0.1
6-05	Electronic thermal overload relay	0: Not used 1: Act with standard motor 2: Act with special motor	0
6-06	Electronic thermal characteristic	30~600 Sec	60
6-07	Present fault record	0: No fault occurred	0
6-08	Second most recent fault record	1: oc (over current) 2: ov (over voltage)	
6-09	Third most recent fault record	3: oH (over heat) 4: oL (over load)	
6-10	Forth most recent fault record	5: oL1 (electronic thermal) 6: EF (external fault)	
6-11	Fifth most recent fault record	7: Reserved 8: Reserved	
6-12	Sixth most recent fault record	9: ocA (current exceed during acceleration) 10: ocd (current exceed during deceleration) 11: ocn (current exceed during steady state)	



Group 7: Motor Parameters

	Parameters	Functions	Settings	Factory Setting
↗	7-00	Motor rated current	30~120 %	85
↗	7-01	Motor no-load current	0 ~ 90 %	50
↗	7-02	Torque compensation	0 ~ 10	1
↗	7-03	Slip compensation	0.0 ~ 10.0	0.0

Group 8: Special Parameters

	Parameters	Functions	Settings	Factory Setting
	8-00	DC braking voltage level	0 ~ 30%	0
	8-01	DC braking time during start-up	0.0 ~ 60.0 Sec	0.0
	8-02	DC braking time during stopping	0.0 ~ 60.0 Sec	0.0
	8-03	Start-point for DC braking	0.0 ~ 400.0 Sec	0.0
	8-04	Momentary power loss	0: Stop operation after momentary power loss. 1: Continues after momentary power loss, speed search starts with master freq. 2: Continues after momentary power loss, speed search starts with min. output freq.	0
	8-05	Max. allowable power loss time	0.3 ~ 5.0 Sec	2.0
	8-06	B.B. time for speed search	0.3~5.0 Sec	0.5
	8-07	Max. speed search current level	30~200%	150
	8-08	Skip freq. 1 upper bound	0.0~400 Hz	0.0
	8-09	Skip freq. 1 lower bound	0.0~400 Hz	0.0
	8-10	Skip freq. 2 upper bound	0.0~400 Hz	0.0
	8-11	Skip freq. 2 lower bound	0.0~400 Hz	0.0
	8-12	Skip freq. 3 upper bound	0.0~400 Hz	0.0
	8-13	Skip freq. 3 lower bound	0.0~400 Hz	0.0



Parameters	Functions	Settings	Factory Setting
8-14	Auto restart after fault	0~10	0
8-15	AVR function	0: AVR function enable 1: AVR function disable 2: AVR function disable when decel	2
8-16	Dynamic braking voltage	350 ~ 450V	380
8-17	DC braking lower bound limit	0.0 ~ 400 Hz	0.0

Group 9: Communication Parameters

Parameters	Functions	Settings	Factory Setting				
⚡ 9-00	Communication address	1 ~ 247	1				
⚡ 9-01	Transmission speed	0: Baud rate 4800 1: Baud rate 9600 2: Baud rate 19200	1				
⚡ 9-02	Transmission fault treatment	0: Warn and continue running 1: Warn and ramp to stop 2: Warn and coasting stop 3: No warn and keep running	0				
⚡ 9-03	Modbus communication watchdog timer	0: Disable 1~20: 1 ~ 20 Sec	0				
⚡ 9-04	Communication protocol	<table border="1"> <tbody> <tr> <td>ASCII mode</td> <td>0: 7,N,2 1: 7,E,1 2: 7,O,1 3: 8,N,2 4: 8,E,1 5: 8,O,1</td> </tr> <tr> <td>RTU mode</td> <td>6: 8,N,2 7: 8,E,1 8: 8,O,1</td> </tr> </tbody> </table>	ASCII mode	0: 7,N,2 1: 7,E,1 2: 7,O,1 3: 8,N,2 4: 8,E,1 5: 8,O,1	RTU mode	6: 8,N,2 7: 8,E,1 8: 8,O,1	0
ASCII mode	0: 7,N,2 1: 7,E,1 2: 7,O,1 3: 8,N,2 4: 8,E,1 5: 8,O,1						
RTU mode	6: 8,N,2 7: 8,E,1 8: 8,O,1						



SPECIFICATIONS

Voltage Class		115V		230V			
Model Number VFD-□□□L□□A/B		002	004	002	004	007	015
Applicable Motor Output (kW)		0.2	0.4	0.2	0.4	0.7	1.5
Output Rating	Rated Output Capacity (KVA)	0.6	1.0	0.6	1.0	1.6	2.7
	Rated Output Current (A)	1.6	2.5	1.6	2.5	4.2	7.0
	Max. Output Voltage (V)	3-phase corresponds to double input voltage		Three-phase corresponds to input voltage			
	Rated Frequency (Hz)	1.0~400Hz					
Power	Rated Input Current (A)	6	9	4.9/1.9	6.5/2.7	9.7/5.1	*/9
	Input voltage Tolerance	Single phase 90~132V 50/60Hz		Single / 3-phase 180~264V 50/60Hz			3-phase 180~264V 50/60Hz
	Frequency tolerance	±5%					
Control Characteristics	Control system		SVPWM (Sinusoidal Pulse Width Modulation, carried frequency 3kHz~10kHz)				
	Output Frequency Resolution		0.1Hz				
	Torque Characteristics		Including the auto-torque, auto-slip compensation, starting torque can be 150% at 5 Hz				
	Overload Endurance		150% of rated current for 1 minute				
	Accel/Decel Time		0.1~600Sec. (can be set individually)				
	V/F pattern		V/F pattern adjustable				
	Stall Prevention Level		20~200%, setting of Rated Current				
Operating Characteristics	Frequency Setting	Keypad	Setting by ▲▼ keys or V.R				
		External Signal	Potentiometer-5KΩ/0.5W, DC 0 ~ +10V (input impedance 100KΩ), 4~20mA (output impedance 250Ω), multi-function inputs 1 to 3 (3steps, JOG, UP/DOWN command), communication setting				
	Operation Setting	Keypad	Setting by RUN//STOP keys				
	Signal	External Signal	M0,M1,M2,M3 can be combined to offer various modes of operation, RS-485 communication port				
	Multi-function Input Signal		Multi-step selection 0 to 3, Jog, accel/decel inhibit, first/second accel/decel switch, counter, PLC Operation, external Base Block (NC,NO) selection				
Multi-function Output Signal		AC Drive Operating, Frequency Attained, Non-zero speed, Base Block, Fault Indication, Local/Remote indication, PLC Operation indication.					
Other Function		AVR, S-curve, Over-Voltage Stall Prevention, DC Braking, Fault Records, Adjustable Carried Frequency, Starting Frequency Setting of DC Braking , Over-Current Stall Prevention, Momentary Power Loss restart, Reverse Inhibition, Frequency Limits, Parameter Lock/Reset					
Protection		Over Voltage, Over Current, Under Voltage, Overload, Electronic thermal, Overheating, Self-testing					
Other		Including EMI Filter					
Cooling		Forced air-cooling					
Environment	Installation Location		Altitude 1,000 m or below, keep from corrosive gasses, liquid and dust				
	Ambient Temperature		-10℃~40℃ (Non-Condensing and not frozen)				
	Storage Temperature		-20℃ to 60℃				
	Ambient Humidity		Below 90%RH (non-condensing)				
	Vibration		9.80665m/s ² (1G) less than 20Hz, 5.88m/s ² (0.6Gat) 20 to 50Hz				

ACCESSORIES

B.1 Non-fuse Circuit Breaker Chart

Per UL 508C, paragraph 44.8.6, part a,

1. For 1-phase drives, the current rating of the breaker shall be four times maximum of input current rating.
2. For 3-phase drives, the current rating of the breaker shall be four times maximum of output current rating.

(Note: Please select enough current capacity of NFB.)

1-phase		3-phase	
Model	Input Current (A)	Model	Output Current (A)
VFD002L11A	6.0	VFD002L21A	1.6
VFD002L21A	4.9	VFD004L21A	2.5
VFD004L11A	9.0	VFD007L21A	4.2
VFD004L21A	6.5	VFD015L23A	7.5
VFD007L21A	9.7		

Fuse Specification Chart

Smaller fuses than those shown in the table are permitted.

Model	I (input)(A)	I (output)(A)	Line Fuse	
			I (A)	Bussmann P/N
VFD002L11A	6.0	1.6	15(20)	JJN-15(20)
VFD002L21A(1 Ø/3 Ø)	4.9/1.9	1.6/1.6	15/6.4	JJN-15/JJN-6
VFD004L11A	9.0	2.5	30	JJN-30
VFD004L21A(1 Ø/3 Ø)	6.5/2.7	2.5/2.5	20/10	JJN-20/JJN-10
VFD007L21A(1 Ø/3 Ø)	9.7/5.1	4.2/4.2	30/16.8	JJN-30/JJN-15
VFD015L23A	9.0	7.5	30	JJN-30

B

DIMENSIONS

Unit: mm (inches)

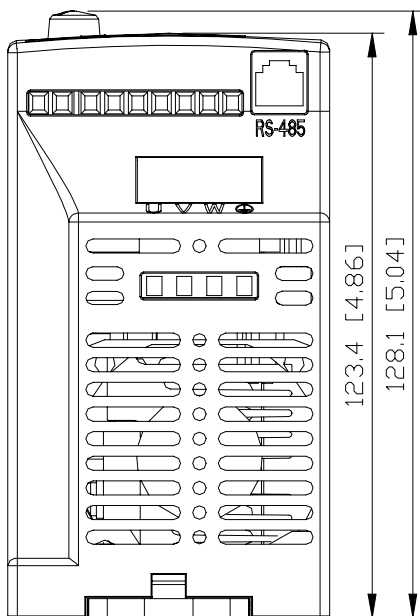
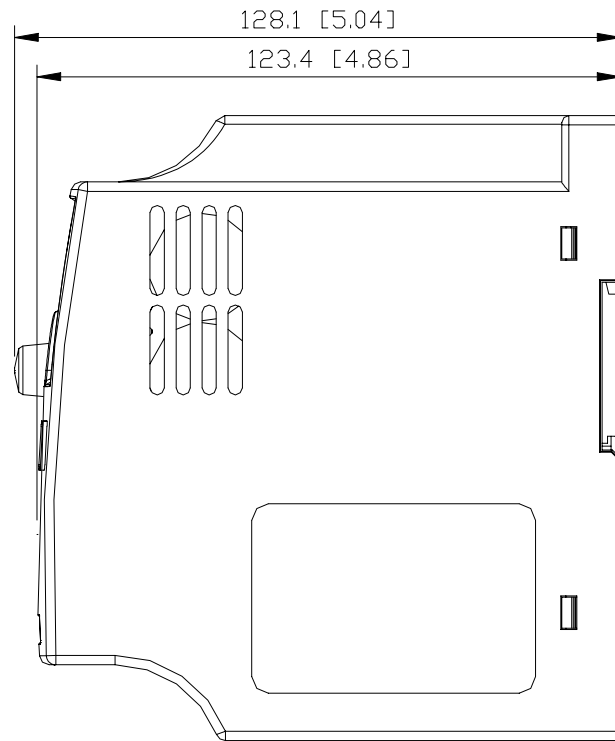
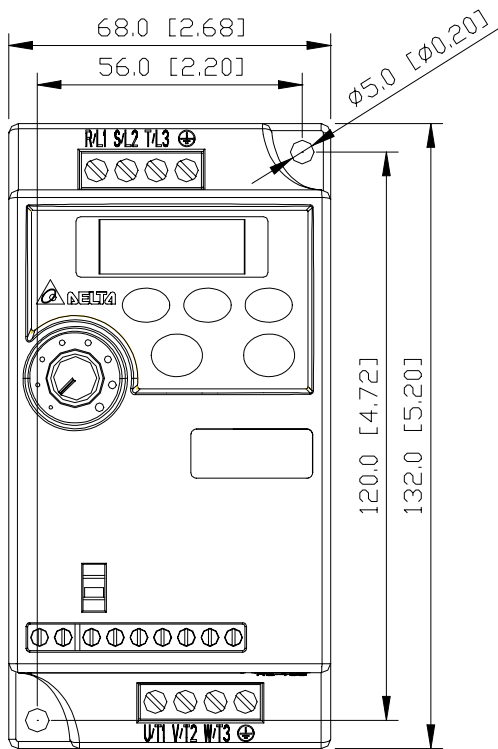



DELTA ELECTRONICS, INC.

**EC Declaration of Conformity
According to the Low Voltage Directive 73/23/EEC and the
Amendment Directive 93/68/EEC**

For the following equipment:

AC Motor Drive

(Product Name)

VFD002L11A, VFD002L11B, VFD002L21A, VFD002L21B, VFD004L11A,
VFD004L11B, VFD004L21A, VFD004L21B, VFD007L21A, VFD007L21B,
VFD015L23A

(Model Name)

is herewith confirmed to comply with the requirements set out in the Council Directive 73/23/EEC for electrical equipment used within certain voltage limits and the Amendment Directive 93/68/EEC. For the evaluation of the compliance with this Directive, the following standard was applied:

EN 50178

The following manufacturer/importer is responsible for this declaration:

Delta Electronics, Inc.

(Company Name)

31-1, Shien Pan Road, Kuei San Industrial Zone, Taoyuan Shien, Taiwan,
R.O.C.

(Company Address)





EC Declaration of Conformity
According to the Electromagnetic Compatibility 89/336/EEC and
the Amendment Directive 93/68/EEC

For the following equipment:

AC Motor Drive

(Product Name)

VFD002L11A, VFD002L11B, VFD002L21A, VFD002L21B, VFD004L11A,
VFD004L11B, VFD004L21A, VFD004L21B, VFD007L21A, VFD007L21B,
VFD015L23A

(Model Designation)

is herewith confirmed to comply with the requirements set out in the Council Directive 89/336/EEC for electromagnetic compatibility and the Amendment Directive 93/68/EEC. For the evaluation of the compliance with this Directive, the following standard was applied:

EN61800-3, EN55011, EN61000-4-2, EN61000-4-3, EN61000-4-4,
EN61000-4-5, EN61000-4-6, EN61000-4-8

The following manufacturer/importer is responsible for this declaration:

Delta Electronics, Inc.

(Company Name)

31-1, Shien Pan Road, Kuei San Industrial Zone, Taoyuan Shien, Taiwan,
R.O.C.

(Company Address)