



CONTENTS

Controller

22
page
Temperature
Controllers 

52
page
Recorders 

54
page
Digital Counter /
Timers 

52
page
Analog Timers 

67
page
Multi Pulse
Meters 

74
page
Electrode Level Switch,
Data Storage Device
Communication Converter,
Temperature and Humidity Converter 

Sensor

76
page
Proximity Sensors 

88
page
Photo Sensors 

103
page
Rotary Encoders 

Electric Power Device

107
page
Thyristor Power
Regulators 

115
page
Solid State Relays 

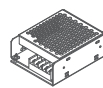
128
page
Power supplies 

Control switch

131
page
Control Switches /
Combination Display Lights 

139
page
Power / Main /
Cam switches 

142
page
Limit Switches 

144
page
Micro Switches 

145
page
Foot/Mono Lever/
Pendant Switches 

Sign Towers & Lights

149
page
Sign Towers 

154
page
Wall Mounted Lights 

155
page
Turn Lights 



157
page
Warning Lights 





Etc



158
page
Terminal Blocks, Power Buzzers,
Fuse Holders, Control Boxes 

Selection Table



Temperature Controllers



Type	LCD Temperature Controllers	
Model	VX series	
Appearance	 	
Features	<ul style="list-style-type: none"> Wide viewing angle LCD and white backlight Several input sensor support (TC, RTD, Voltage, Current) High precision (0.2 % accuracy) 	<ul style="list-style-type: none"> High speed sampling cycle (50 ms) IP65 (IEC 60529) front degree of protection Convenient parament setting by USB cable
Power voltage	100-240 V a.c. 50/60 Hz, 24 V d.c., Class2	
Accuracy	±0.2 % of FS ± 1 digit	
Input	RTD, thermocouple, DC voltage, DC current	
Output	Relay output, SSR output, current output	
Control type	ON/OFF, PID control, 2DOF PID control	
Page	22	



Type	Multi Input / Output Temperature Controllers	Easy Operation Temperature Controllers	Multi Input Temperature Controllers	
Model	NX series	DX series	AX series	KX series
Appearance				
Features	<ul style="list-style-type: none"> Fuzzy function, PID auto-tuning 3 zone PID/ Group PID 3 types Ramp control function Heating / cooling control, Heater break alarm 3 set value type selection function by digital input (DI) Communication function (RS485/422) 	<ul style="list-style-type: none"> PID auto-tuning Direct/reverse operation internal selection High and Low alarm output Control loop break alarm (LBA) Decimal point display and high / low setting limitation Retransmission output 	<ul style="list-style-type: none"> Multi Input High speed sampling cycle (0.1 sec) Installation depth: 63 mm Control output selectable : reverse operation/ direct operation Control loop break alarm (LBA) 	<ul style="list-style-type: none"> Multi Input Decimal point position selection 2-stage step function by external contact (KX4S) Output operation selectable : reverse operation/direct operation PID auto-tuning
Power voltage	100-240 V a.c. 50/60 Hz, 24 V d.c.		100-240 V a.c. 50/60 Hz	100-240 V a.c. 50/60 Hz, 24 V d.c.(Exclude KX4S)
Accuracy	0.5 % of FS		±0.3 % of FS	0.5 % of FS
Input	RTD, thermocouple, DC voltage			
Output	Relay output, SSR output, current output			
Control type	PID control/ ON-OFF control			
Page	26	28	25	30

Type	Multi-Channel Digital Temperature Controllers	Modular Multi-Channel Temperature Controllers	Multi Input Temperature Controllers
Model	MC9	ML series	MT100
Appearance			
Features	<ul style="list-style-type: none"> 4/8 channel control function Multi-memory function (ax 8 X 8) Heating / cooling control (4 channels) Digital input(DI) Communication function (RS232, RS485/422) 	<ul style="list-style-type: none"> Sampling cycle 50 ms 8 Event output contact units Max. 32 parallel connections (including ML-E) Unit power, communication connection by side connector Communication function (RS232C, RS485) 	<ul style="list-style-type: none"> Input 4 channels (control: 2 channels, monitoring: 2 channels) Temperature, pressure, current detection alarm functions Abnormal history display and saving functions Medium replenishment and suction function Communication function (RS485/422)
Power voltage	100-240 V a.c. 50/60 Hz		100-240 V a.c. 50/60 Hz
Accuracy	±0.3 % of FS ±1 Digit		Temperature : ±0.3 % of FS ± 1 Digit Pressure : ±3 % of FS ±1 Digit
Input	RTD, thermocouple, DC voltage		RTD, thermocouple
Output	Relay output, SSR output, current output, Triac output	Relay output, SSR output, current output	
Control type	PID control / ON-OFF control		PID control
Page	40	38	39



■ Temperature Controllers





Type	Modular Programmable Temperature Controllers	2-Channel Programmable Temperature Controllers
Model	TD510	TD300
Appearance		
Features	<ul style="list-style-type: none"> · Several alarm functions · Multi input (RTD, TC, VDC) · Communication function built-in (RS485) · Detachable and expandable structure · Digital Recorder function (internal memory, SD card storage) · Digital input (DI) max. 32 contacts, digital output (DO) max. 32 contacts 	<ul style="list-style-type: none"> · Max. 100 patterns, 100 segments/pattern (total 2,400 segments) · Several alarm functions (output: 4 contacts, operation: 20 types) · Digital input (DI) 8 contacts, Digital output (DO) 8 contacts · Communication function
Power voltage	100-240 V a.c. 50/60 Hz	
Accuracy	±0.15 % of FS	±0.1 % of FS
Input	RTD, thermocouple, DC voltage	
Output	Relay output, SSR output, current output	
Control type	PID control/ ON-OFF control	
Page	32	33



Type	Modular Programmable Temperature & Humidity Controllers	Programmable Temperature & Humidity Controllers
Model	TH510	TH300
Appearance		
Features	<ul style="list-style-type: none"> · Communication function built-in (RS485) · Detachable and expandable structure · Temperature, humidity independent PID control · Digital recorder function (internal memory, SD card storage) · Digital input (DI) max. 32 contacts, digital output (DO) max. 32 contacts 	<ul style="list-style-type: none"> · 100 patterns (total 2000 segments, 100 segments / pattern) · Temperature, humidity independent PID control · Digital input (DI) 4 contacts, digital output (DO) 12 contacts · Communication function
Power voltage	100-240 V a.c. 50/60Hz	
Accuracy	Temperature: ±0.1 % of FS / Humidity: ±1 % of FS	Temperature: ±0.2 % of FS / Humidity: ±2 % of FS
Input	RTD, DC voltage	
Output	SSR output, current output	
Control type	PID control/ ON-OFF control	
Page	34	35

Type	Thermal Shock Test Controllers	Programmable Temperature Controllers
Model	TS510	NP200
Appearance		
Features	<ul style="list-style-type: none"> · Damper & elevator method support · Multi input(RTD, TC, VDC) · Communication function built-in(RS485) · Detachable and expandable structure · Digital Recorder function (internal memory, SD card storage) · Digital input (DI) max. 32 contacts, digital output (DO) max. 32 contacts 	<ul style="list-style-type: none"> · Multi input / output, ± 0.1 % high accuracy · 30 patterns, 300 segment (1 pattern / 99 segments) · Heating / cooling PID control · 3-level PID selection (4 PID groups) · PID auto-tuning mode 2 types · Digital input (DI) 7 contacts, User output (UO) 10 contacts · Communication function
Power voltage	100-240 V a.c. 50/60Hz	
Accuracy	RTD : ±0.1% of FS, thermocouple : ±0.15 % of FS	±0.1 % of FS
Input	RTD, thermocouple, DC voltage	
Output	SSR output, current output	
Control type	PID control/ ON-OFF control	
Page	37	36



Selection Table

Type	Board Type Temperature Controllers		Cost-Effective Digital Temperature Controllers
Model	BX8	SM100	ED6
Appearance			
Features	<ul style="list-style-type: none"> Fuzzy function, PID auto-tuning 3 zone PID/ Group PID 3 types Ramp control function Heating / cooling control, Heater break alarm 3 set value type selection function by digital input (DI) Communication function (RS485) 	<ul style="list-style-type: none"> 20 Channel integrated digital temperature controller ± 0.5% display accuracy of max. range Several alarm functions. (digital output 3 contacts) Communication function built-in (RS485/422, RS232C) 	<ul style="list-style-type: none"> Heating/cooling control selection Alarm output and timer output selection ON/OFF, Proportional control selection 0.1 °C / 1 °C selection Delay output time setting
Power voltage	100-240 V a.c. 50/60 Hz		100-240 V a.c. 50/60 Hz, 10-24 V a.c. 50/60 Hz or 10-24 V d.c.
Accuracy	±0.5% of FS ±1 Digit	±0.5 % of FS	±0.5 % of FS ±1 Digit
Input	RTD, thermocouple, DC voltage		RTD, thermocouple
Output	Relay output, SSR output, current output		Relay output, SSR output
Control type	PID control/ ON-OFF control		Proportional control, ON/OFF control
Page	43	42	49

Type	Easy Operation Temperature Controllers		Temperature Controllers Without Indicator	
Model	HY-8000S / 8200S / 72D / 48D	DF2	HY-1000, HY-2000, ND4	ND4
Appearance				
Features	<ul style="list-style-type: none"> Proportional control or ON / OFF control Convenient temperature setting Alarm setting (HY-8200S) Sharp digital display 	<ul style="list-style-type: none"> Proportional control or ON / OFF control Convenient temperature setting Auxiliary output setting (SUB) Sharp digital display 	<ul style="list-style-type: none"> Proportional control or ON/OFF control Convenient temperature setting Plug-in method Burnout function Strong against vibrations and impacts, so it can be installed directly on the machine 	
Power voltage	110/220 V a.c. 50/60Hz (Common)	110/220 V a.c. 50/60 Hz (Common)	HY-1000 : 110/220 V a.c. 60 Hz (Common) HY-2000 : 110/220 V a.c. 60 Hz (Common)	110 V a.c. 60 Hz, 220 V a.c. 60 Hz ※ The ND4 power voltages are divided into 110 V and 220 V specifications.
Accuracy	±1 % of FS ±1 Digit		Non-indicating	
Input	RTD, thermocouple, DC voltage		RTD, thermocouple	
Output	Relay output, SSR output, current output		Relay output	
Control type	Proportional control			
Page	44	45	46	47

Type	Temperature Controllers For Refrigerators		Temperature Controllers For Greenhouses
Model	BR6A	BR6	HD6
Appearance			
Features	<ul style="list-style-type: none"> Heating/cooling control selection Alarm output, timer output selection ON/OFF, Proportional control selection 0.1°C / 1°C selection Delay output time setting Operation convenience improved with the set move key 	<ul style="list-style-type: none"> Heating/cooling control selection Alarm output and timer output selection ON/OFF, Proportional control selection 0.1 °C / 1 °C selection Delay output time setting 	<ul style="list-style-type: none"> Greenhouse open / close motor control only 1-, 2-stage control operation according to set value Hysteresis setting by ON/OFF output Operation according to temperature and time setting 0.1 °C display function
Power voltage	100-240 V a.c. 50/60 Hz or 100-240 V d.c.	100-240 V a.c. 50/60 Hz 10-24 V a.c. 50/60 Hz or 10-24 V d.c.	100-240 V a.c. 50/60 Hz
Accuracy	±1 % of FS ±1 Digit		±1 % of FS
Input	Hanyoung Nux exclusive sensor (TH-570N)		Hanyoung Nux exclusive sensor (TH-540N)
Output	Relay output, SSR output		Relay output
Control type	Proportional control, ON/OFF control		
Page	48		49



■ Temperature Indicators

Type	Digital Temperature Indicators	Multi Input Temperature Indicators
Model	BK3	BK6-M
Appearance		
Features	<ul style="list-style-type: none"> · 0.5 % high accuracy indicator · Simple exclusive indication · Character height 14.2/20.0 mm LED applied 	<ul style="list-style-type: none"> · Multi Input (thermocouple, RTD, voltage · current) · Retransmission output (4 - 20 mA d.c.) · Temperature unit selection · Measured value correction function
Power voltage	110/220 V a.c. 50/60Hz(Common)	100-240 V a.c. 50/60 Hz
Accuracy	±0.5 % of FS	±0.5 % of FS ±1 Digit
Input	RTD, thermocouple, DC voltage, DC current	Multi Input (19 types), thermocouple, RTD
Page	50	51





■ Data Storage Devices

■ Floatless Level Switches

■ Electrode Holder



Type	Data Storage Devices	Floatless Level Switches	Electrode Holder
Model	EM310	FS - 3A	HY-ER3
Appearance			
Features	<ul style="list-style-type: none"> · 32 Mbyte data storage device · Convenient panel installation type (72 × 36 mm) · USB port for memory stick connection 	<ul style="list-style-type: none"> · Used for agricultural water, water treatment plant, sewage treatment plant, factory and several surface water control · Lightweight and easy to install · Operation status is indicated by LED 	<ul style="list-style-type: none"> · IP63 (IEC 60529) degree of protection · The PBT flame retardant provides robustness and reduces the fire risk · Body and cover are connected by hook coupling structure so they are easily detached by screwdriver
Power voltage	24 V d.c. 500 mA	110 V a.c. 50/60 Hz, 220 V a.c. 50/60 Hz	-
Page	74	75	

■ Converters



Type	Ethernet To Serial Converters	Communication Converters		Temperature / Humidity Converters
Model	HMCE-103	CV310	CV300	CV250
Appearance				
Features	<ul style="list-style-type: none"> · Several connection interface support (RS232 / RS485 / RS422) · Open network protocol support · Up to 3 clients can be simultaneously connected 	<ul style="list-style-type: none"> · RS232 and RS485 / RS422 · 2 kV electrical insulation built-in protection device · RS485 Echo, Non-Echo function support · Excellent compatibility with fast transmission/reception switching speed · Max. 1.2 Km, 256 Node connection available 	<ul style="list-style-type: none"> · RS422/485 Line Drive Automatic Control · Switch settings enable/disable various modes of operation · Up to 1.5 km, 256 node connectivity · LED for Power and Data Communication Status Indication 	<ul style="list-style-type: none"> · DIN rail and bolt fixing mounting method · Uniform with DC signal · Relative humidity calculation by dry bulb temperature and wet bulb temperature · Two-wire transmission line is simple · Linear signal
Power voltage	5 V d.c. (±10 %)	9-30 V d.c.	9 V, 300mA d.c. Adapter (1.3 Ø d.c Jack)	100-240V a.c. 50/60 Hz
Page			74	



Selection Table

Recorders

Type	Touch Screen Recorders		2-channel temperature controllers & recorders	
Model	GR200A		RT9N	
Appearance	 			
Features	<ul style="list-style-type: none"> High-definition screen : 5.7" 640×480 TFT-LCD Large memory: SD and SDHC card support (internal memory: 80 MB) 3-language support: Korean, English, Chinese (simplified) Data storage and parameter backup function with SD card RS485/422/ETHERNET 		<ul style="list-style-type: none"> Multi input/output Communication function(RS485) Free scale function PID auto-tuning Temperature record & control 	
Power voltage	100-240 V a.c. 50/60 Hz			
Accuracy	±0.15 % of FS ±1 Digit		±0.5 % of FS	
Input	RTD, thermocouple, DC voltage			
Channels	2/4/8/12 channels		1/2 channels	
Contact outputs	6contacts, 12contacts		Alarm: 2 contacts, Control output: 1 contact	
Page	52		53	



Counter / Timers



Type	LCD Counter / Timers	
Model	LC series	
Appearance	 	
Features	<ul style="list-style-type: none"> Improved visibility with the wide viewing angle LCD and white display Using the tack switch and applying ABS material (enhanced durability) IP66 Protection Structure (Front of Product) Pre-scale setting range expanded (0.00001 ~ 999999) Support for RS485 Communication (Modbus RTU) 	
Power voltage	100-240 V a.c. 50/60 Hz, 24-48 V a.c. 50/60 Hz or 24-48 V d.c. (Voltage fluctuation rate: ±10 %)	
Type	Preset method	
Control functions	Counter, Timer	
Display digits	4 digits, 6 digits	
Setting stages	1-stage setting, 2-stage setting	
Page	54	

Type	Digital Counter / Timers	Digital Counter
Model	GF series	LC1
Appearance	 	
Features	<ul style="list-style-type: none"> Counter & timer functions Pre-scale setting (GF7) 14 input operations, 16 output operations Decimal places setting 16 timer ranges (decimal / sexagesimal 8 types) NPN/PNP (voltage / non-voltage) input selection 	<ul style="list-style-type: none"> Compact LCD indicating total counter External power not needed with the built-in battery You can reuse the product by replacing the battery Small Power consumption and long battery life Non-voltage or voltage input IP66 (IEC 60529) degree of protection (front side)
Power voltage	100-240 V a.c. 50/60 Hz	Lithium battery built-in
Type	Preset method, Indication only	Indication only
Control functions	Counter, Timer	Counter
Display digits	4 digits, 6 digits	8digits (addition)
Setting stages	1-stage setting, 2-stage setting	-
Page	55	56

■ Timers





Type	LCD Timers	
Model	LT4 / LT4S	
Appearance		
Features	<ul style="list-style-type: none"> Bright and easy to view with the wide viewing angle LCD IP66 Protection Structure (Front of Product) Time limit 1c, Instantaneous 1c + Time limit 1c, Time limit 2c, STAR + DELTA Minimum signal time selection (1 ms / 20 ms) 	<ul style="list-style-type: none"> Several time ranges (0.01 sec ~ 9999 hrs) Several operation modes (LT4: 7 operation modes, LT4S: 10 operation modes) One-shot output time setting (0.01 sec ~ 99.99 sec)
Power voltage	24 - 240 V a.c. 50/60 Hz or 24 - 240 V d.c.	
Display digits	4 digits	
Time specs	0.01 sec ~ 9999 hour	
Page	57	

Type	LCD Timers		LCD Weekly & Yearly Time Switches
Model	LT1	LF4N	LY series
Appearance			
Features	<ul style="list-style-type: none"> External power not needed with the built-in battery You can reuse the product by replacing the battery Long battery life with small power consumption Non-voltage or voltage input IP66 Protection Structure (Front of Product) 	<ul style="list-style-type: none"> LCD display (displays several functions) Multi input ranges (10 types) Multi output operations (10 types) Bar graph over time display Reset, start and inhibit inputs 	<ul style="list-style-type: none"> Easy to check and change programs Automatic change of seasonal program according to season setting function It is possible to add the yearly program to the weekly program The holiday setting function can block the output during the selected holidays
Power voltage	Lithium battery built-in	24-240 V a.c. 50/60 Hz or 24-240 V d.c.	100-240 V a.c. 50/60 Hz
Display digits	8 digits (addition)	3 digits	4 digits, 2 lines
Type	Indication only	-	-
Time specs	-	0.01 s ~ 9990 h	Minimum spacing interval: 1 minute
Page	56	60	61



Type	Digital Twin Timers		Digital Timers
Model	TT7H	TT4	TF4A
Appearance			
Features	<ul style="list-style-type: none"> Output operation control according to external START input signal Individual setting of ON time and OFF time Wide power specifications (100 - 240 V a.c. 50/60 Hz) 	<ul style="list-style-type: none"> Free voltage (100 - 240 V a.c. 50/60 Hz) Dual timer & twin timer functions (Can be used as 2 independent timers) Output operation control according to external input signal (START, RESET, INHIBIT) 	<ul style="list-style-type: none"> Simple functions, convenient setting Range selection with front side deep switch (2 types) Decimal or sexagesimal Relay or transistor output
Power voltage	220 V a.c. 60Hz	100-240 V a.c. 50/60Hz	100-240 V a.c. 50/60 Hz, 24-60 V d.c.
Display digits	4 digits		3 digits, 4 digits
Time specs	0.01 s ~ 9999 hour		Refer to standard range
Page	58		59



Selection Table

Analog Timer



Type	Timing Relays	ON-Delay Timer	Twin / Dual Timers	Multi Timers	Star-Delta Timers
Model	T21	T38N, T48N, T57N	TF62N, TF62D	MA4N	MA4SD
Appearance					
Features	<ul style="list-style-type: none"> Timing Relay (time limit 4c) Plug-in type (14 pins) Time range and operation mode customizable by the user Several time ranges Multi operation mode 	<ul style="list-style-type: none"> Time progress display using ON LED Several time ranges (7 types) Time unit selectable (hours, minutes, seconds) Several model configurations (5 types) 	<ul style="list-style-type: none"> Time progress display using ON LED Several time ranges (7 types) Time unit selectable (hours, minutes, seconds) Several model configurations (5 types) 	<ul style="list-style-type: none"> Output operation modes (6 types) Multi range (4 types) Time units (4 types) Reset, start and inhibit inputs 	<ul style="list-style-type: none"> 8-pin plug type High capacity motor start timer Star-delta contact outputs, Instantaneous contact outputs Wide power specifications (AC/DC dual usage)
Power voltage	100-120 V a.c. 50/60 Hz, 200-230 V a.c. 50/60 Hz, 24 V d.c.	24-240 V a.c. 50/60 Hz or 24-240 V d.c., 12 V d.c.(T48N Only, Order Specification)	24-240 V a.c. 50/60 Hz or 24-240 V d.c.		100-240 V a.c. 50/60 Hz, 24-240 V d.c.
Time specs	0.1 s ~ 24 hour	0.01 s ~ 60 hour	Time range selection (3 types)	Minimum spacing interval : 1 minute	1~300 s
Page	62	63	64	65	66



Multi Pulse Meters



Type	LCD Multi Pulse Meters	
Model	LP3	
Appearance		
Features	<ul style="list-style-type: none"> Improved visibility with the wide viewing angle LCD and white display 66.4 mm Short Back Length IP66 Protection Structure (Front of Product) 	<ul style="list-style-type: none"> Expand Maximum Display Range : -99999 ~ 99999 Various functions : AUTO ZERO, Start compensation timer, comparative output limit, hysteresis, Set display period, select time unit, display maximum and minimum values, electrostatic memory, etc.
Power voltage	100-240 V a.c. 50/60 Hz	
Operation modes	Number of revolutions, frequency, speed, Moving speed, cycle, transit time, time difference, time width, measured length, interval, integration, absolute ratio, error ratio, density, error	
Input frequency	Contactless (max. 50 KHz, ON/OFF pulse width 10 us min), contact (max. 30 Hz, ON/OFF pulse width min. 16.6 ms)	
Display cycle	0.05, 0.5, 1, 2, 4, 8 sec	
Output	Proportional control, ON/OFF control	
Page	67	

Type	Small LCD Pulse Meters	Multi Pulse Meters	Digital Wattmeters
Model	LP1	BP6	WM3
Appearance			
Features	<ul style="list-style-type: none"> Small LCD Pulse Meters Rotation speed / Frequency measurement 5-digit display available External power not needed with the built-in battery Non-voltage or free voltage input 	<ul style="list-style-type: none"> Auto zero time setting Comparative output (HH, H, GO, L, LL) Start compensation timer function Max. value (5 types), min value (5 types) save Power outage compensation function Max. 50 KHz 	<ul style="list-style-type: none"> Effective power display by RMS measurement Converter not needed with the voltage and current measurement method Several outputs (Relay 4 - 20 mA d.c open collector)
Power voltage	Lithium battery built-in	100-240 V a.c. 50/60 Hz, 24-60 V a.c. 50/60 Hz or 24-60 V d.c.	100-240 V a.c. 50/60 Hz
Operation modes	Revolution speed, frequency	Number of revolutions, frequency, speed, Moving speed, cycle, transit time, time difference, time width, pulse width, pulse interval, integration counter, absolute ratio, error ratio, density, error	<ul style="list-style-type: none"> Remote local switching (communication output type) Display max / min value by front key Function of handling average value and delaying displaying cycle Changing comparative output setting Set value changing protective function
Input frequency	-	50 KHz	-
Display cycle	-	0.05, 0.5, 1, 2, 4, 8 sec	Min. : 0.1 second, Max. 2 second
Output	-	Relay, transistor	Display only, 4 - 20 mA d.c. relay (HI, GO, LO), transistor, communication (RS485)
Page	68	72	70

Selection Table





Type	LCD Multi Panel Meters	
Model	LM	
Appearance		 
Features	<ul style="list-style-type: none"> · Use optical night angle LCD and white backlight · Short rear length of 68 mm (LM3) and 81 mm (LM6) · IP66 Protection Structure (Front of Product) 	<ul style="list-style-type: none"> · RMS and AVG Selection Instrumentation · MODBUS Communication Support · Maximum measurement input specification (500 V d.c., 500 V a.c., 5A d.c., 5A a.c.)
Power voltage	100-240 V a.c. 50/60 Hz	
Display digits	-9999 ~ 9999	
Functions	Operation mode (6), hysteresis, alternating current frequency measurement, zero adjustment, initialization, lower display deviation correction, key lock transmission output scale adjustment, start compensation timer, free scale, slope adjustment, error correction, display period delay, maximum/minimum monitoring,	
Input	· DV: DC voltage · DA: DC current · AV: AC voltage / frequency · AA: AC current / frequency	
Output	· Contact Output : 3-layer, SPST (1a), 250 V a.c. 5A · Contactless output : 3-speed, NPN/PNP, Open Collector, 12-24 V d.c. 50mA · Transmission Output (4-20 mA), RS485 Output	
Page	69	

Type	Digital Scale Meters	Non-Power Scale Meters
Model	HP3	HLP1
Appearance		
Features	<ul style="list-style-type: none"> · High accuracy indicator ($\pm 0.03\%$ of F.S) · Max. display (-19999 ~ 19999) · Communication function (RS232 or RS485) selection 	<ul style="list-style-type: none"> · Non-power free scale · High accuracy indicator ($\pm 0.3\%$ of FS) · Max. display (-1999 ~ 9999) · Current input (4-20mA d.c.)
Power voltage	100-240 V a.c. 50/60 Hz	Non-power
Display digits	± 19999	-1999 ~ 9999
Functions	Scale meter	
Input	1 channel 1 - 5 V d.c., 4 - 20 mA d.c.	4-20mA d.c.
Output	4 - 20 mA d.c. Alarm output 2 contacts	Indication only
Page	72	68



Type	Digital Voltmeter / Ammeters	
Model	BS	BA1
Appearance		
Features	<ul style="list-style-type: none"> · Bright and clear LED display · Cost-effective · Max. display 1999 · Average value measurement 	<ul style="list-style-type: none"> · Bright and clear LED display · Cost-effective · Max. display 1999
Power voltage	BS1: 100-240 V a.c. 50/60 Hz, BS3/6: 110/220 V a.c. 50/60 Hz (Common)	5 V d.c., 12-24 V d.c.
Display digits	± 19999	
Functions	Polarity display (BS3) Indication value hold by external contact	Decimal point and polarity display over range indication
Input	4 - 20 mA d.c. / 1 - 5 V d.c. AC voltmeter / AC ammeter/ DC voltmeter / DC ammeter	4 - 20 mA d.c. / 1 - 5 V d.c. DC voltmeter / DC ammeter
Output	Indication only	
Page	71	73



Selection Table

■ Proximity Sensors



Type	Inductive Round Type Proximity Sensors	Inductive Square Type Proximity Sensors	Inductive Flat Type Proximity Sensors	Capacitive Type Proximity Sensors
Model	UP□R series	UP□S series	UP□F series	CUP series
Appearance				
Features	<ul style="list-style-type: none"> Wide operating voltage (5-35 V d.c. : DC 3-wire) Noise resistant reinforced circuit 2-wire type nonpolar applied 	<ul style="list-style-type: none"> Wide operating voltage (5-35 V d.c. : DC 3-wire) Noise resistant reinforced circuit 2-wire type nonpolar applied 	<ul style="list-style-type: none"> Wide operating voltage Noise resistant reinforced circuit 2-wire type proximity nonpolar applied 	<ul style="list-style-type: none"> Noise resistant reinforced circuit Leakage current less than 2 mA 20-240 V a.c. 50/60 Hz or 20-240 V d.c.
Power voltage	12-24 V d.c., 100-240 V a.c. 50/60 Hz			12-24 V d.c., 20-240 V a.c. 50/60 Hz or 20-240 V d.c.
Shield	Shield, Non shield	-		Non shield
Sensing distance	1.5, 2, 4, 5, 8, 10, 15 mm	2, 4, 5, 8, 10, 12, 15, 20 mm	8 mm	8, 15 mm
Protective Structure	IP67			
Page	76	81	84	86

■ Photo Sensors

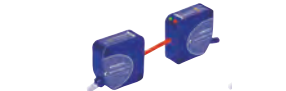

Type	General Purpose Photo Sensors	Amplifier Built-In Photo Sensors	Flat Photo Sensors
Model	PB series	PLD	PY series
Appearance			
Features	<ul style="list-style-type: none"> 25.4mm standard mounting hole Hanyoung Nux new ASIC chip used (operation stability, long-distance detection) Built-in VR for sensitivity adjustment Excellent noise immunity and reduced disturbance of light influence Strong protection circuit 	<ul style="list-style-type: none"> Power reverse connection and output short Diffuse-reflective type with 2 m of sensing distance 1 ms response time Sensitivity adjustment volume built-in 	<ul style="list-style-type: none"> Light ON / Dark ON mode switching selection by control wire Power reverse connection and output short Convenient installation with the ultra slim size (16 X 28 X 8 mm) 1 ms response time Control output and stable output display
Power voltage	12-24 V d.c.		
Sensing mode	Through-beam, Diffuse-reflective, Retro-reflective (mirror), Retro-reflective (polarized mirror), Distance-settable	Diffuse-reflective	Through-beam
Sensing distance	7 m, 10 m, 15 m, 0.1 - 3 m, 1 m, 100 mm, 400 mm	2m	3 m
Operating mode	Light ON, Dark ON	Light ON	Light ON, Dark ON
Operating mode	Max. 1 ms		
Protective Structure	IP65	IP64	IP67
Page	88	94	89

Type	Voltage Output Photo Sensors	Round Photo Sensors	U-Shaped Fast Response Photo Sensors	Long Distance Detection Photo Sensors
Model	PN series	PR series	PU series	PEN series
Appearance				
Features	<ul style="list-style-type: none"> Power reverse connection and output short circuit protecting circuit built-in Motion display light attached Sensitivity adjustment volume attached 	<ul style="list-style-type: none"> Output cutoff over current protecting circuit built-in Sensitivity adjustment volume attached Light ON /Dark ON selection 	<ul style="list-style-type: none"> Solid die casting case Optic axis control not needed Sensitivity adjustment volume attached Operating mode selection by power polarity reverse connection 	<ul style="list-style-type: none"> Long distance detection Stability indication
Power voltage	12-24 V d.c.			24-240 V a.c. 50/60 Hz or 24-240 V d.c.
Sensing mode	Through-beam, Diffuse-reflective, Retro-reflective		Through-beam	Through-beam, Diffuse-reflective, Retro-reflective
Sensing distance	3 m, 0.1 - 1 m, 200 mm	7 m, 10 m, 0.1~2 m, 0.1 m, 0.4m	30 mm, 50 mm	10 m, 0.1 - 5 m, 700 mm
Operating mode	Light ON, Dark ON			
Response time	Max.3 ms	Max.1 ms	Max.1 ms	Max.20 ms
Protective Structure	-	IP66	IP65	IP64
Page	90	91	92	96



■ Photo Sensors

Type	Power /Amplifier Built-In Photo Sensors	Power Built-In Photo Sensors	Distance-settable Photo Sensors
Model	PTX series	PE series	PL-D2B
Appearance			
Features	<ul style="list-style-type: none"> Terminal block type connection for convenient wiring Wide power voltage range Timer function available NPN/PNP open collector simultaneous output with DC power 	<ul style="list-style-type: none"> Cost-effective Wide power voltage Relay output Operation status indication attached Lower impact of dust with the flat lens 	<ul style="list-style-type: none"> Distance setting reflective type by 2 split photo diodes Power reverse connection and output short circuit protective circuit built-in
Power voltage	24-240 V a.c. 50/60 Hz or 24-240 V d.c.	24 V d.c., 100-240 V a.c. 50/60 Hz or 100-240 V d.c.	12-24 V d.c.
Sensing mode	Through-beam , Diffuse-reflective, Retro-reflective		Distance-settable
Sensing distance	15 m, 7 m, 1 m	5 m, 0.1 - 3 m, 500 mm	0.2 - 2 m
Operating mode	Light ON , Dark ON		
Response time	Power built-in type : max. 20 ms Amplifier built-in type : max. 1 ms	Max.25 ms	Max.2 ms
Protective Structure	IP66	IP54	IP65
Page	93	92	95

■ Fiber Optic Sensors

Type	Fiber Optic Sensors		Multi-Function Digital Fiber Optic Sensors
Model	PG series	PFB	PFD
Appearance			
Features	<ul style="list-style-type: none"> Applicable to any application with the AMP unit 4 type and several fiber unit types. Easy to install to a 35 mm wide DIN rail, so less installing space is needed. 	<ul style="list-style-type: none"> Sensitivity setting by auto-teaching External teaching input/external synchronous input Output delay time (40 ms fixed) Light ON/ Dark ON selection by slide switch 	<ul style="list-style-type: none"> Sensitivity setting by auto-teaching 7-Segment 4-digit LED display Mark detection/ counter / tachometer functions (multi-type) Output delay time setting(1~9999 ms)
Power voltage	12-24 V d.c.		
Sensing mode	Through-beam, Diffuse-reflective		
Sensing distance	By fiber optic cable		
Operating mode	Light ON , Dark ON		
Response time	Max. 1 ms		RM : Max. 1 ms, RG : Max. 0.7 ms
Protective Structure	IP40	IP40	IP40
Page	97	99	98

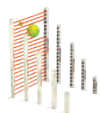
■ Area Sensors



Type	Area Sensors	Area Sensors
Model	PAS series	PAN series
Appearance		
Features	<ul style="list-style-type: none"> Less installation space (thickness : 13.5 mm, width : 30 mm) Automatic sensitivity correction function built-in Minimum sensing object (Ø30 mm) 	<ul style="list-style-type: none"> Several optical axis distances(20/40 mm) Output short circuit protection circuit built-in Operating mode selection (all optical axes/1 optical axis light ON)
Power voltage	12-24 V d.c. ±10% ripple (p-p) 10% or less	
Sensing mode	Through-beam	
Sensing distance	5 m	7 m
Operating mode	Light ON or Dark ON	Emitter : M/S mode switch switching type (Master / Slave) Receiver : D/L mode switch switching type (Dark ON, Light ON)
Response time	Max. 7 ms	Max. 15 ms
Protective Structure	IP40 (IEC Specification)	IP65 (IEC Specification)
Page	100	101

■ Sensor Controllers





Type	Sensor Controllers
Model	HPA-12
Appearance	
Features	<ul style="list-style-type: none"> NPN/PNP dual usage input sensor controller Solid output contact (250 V 3 A, more than 100,000 times) Convenient installation with plug in method
Power voltage	220 V a.c. 50/60 Hz
Functions	Universal
Power consumption	Approx. 4 VA
External output power	12 V d.c., ± 10 %, 50 mA max.
Output	Relay 1c, 250 V a.c., 3A (resistive load)
Page	102

Selection Table





■ Sensor Controllers

Type	Universal	High function (timer)	For connection of 2 connections.
Model	HPAN-C7	HPAN-CT7	HPAN-C7W
Appearance			
Features	· Contact/contactless, 2 outputs built-in (HPAN-C7, HPAN-CT7) · For connecting 2 sensor · Corresponds to DIN rail		
Power voltage	100-240 V a.c. 50/60 Hz ±10 %		
Functions	2 inputs 1 output		2 inputs 2 output
Power consumption	Approx. 5 VA		
External output power	12 V d.c. (± 10 %), load current : max. 200 mA		
Output	Contact	OUT 1	OUT 1, OUT 2
	Contactless	Relay 1 c, 250 V a.c., 3A (resistive load) ※ HPAN - C7W (1 c X 2 relay contact)	
	NPN open collector 30 V d.c., Max. 200 mA		-
Page	102		





■ Rotary Encoders

Type	Ø30, Ø40, Ø50 Shaft Type	Ø40 Hollow Shaft Type	Ø40 Blind Shaft Type	Wheel Type
Model	HE30B, HE40B, HE50B	HE40H	HE40HB	PSC
Appearance				
Features	· Wide power voltage (5 - 12 / 12 - 24 V d.c.) · Several output specifications · Convenient installation structure	· Wide power voltage (5-12 V d.c. / 12-24 V d.c.) · Several output specifications · Convenient installation structure	· Wide power voltage (5-12 V d.c. / 12-24 V d.c.) · Several output specifications · Convenient installation structure	· The wheel type detection structure is suitable for length and speed measurement · Several measuring units (6 types) · Convenient installation structure
Power voltage	5-12 V d.c.±5 %, 12-24 V d.c.±5 %, 5 V d.c.±5 %			5-12 V d.c.± 5 %, 12-24 V d.c.±5 %, 5 V d.c.± 5 %
Output phase difference	Phase difference between A, B phases : T/4±T/8 (1 cycle of A phase=T)			
Response time	Max.1 μs			
Number of pulses	1, 2, 5, 10, 12, 15, 20, 25, 30, 40, 45, 50, 60, 75, 100, 120, 125, 150, 192, 200, 240, 250, 256, 300, 360, 400, 500, 512, 600, 800, 1000, 1024			According to the minimum measured length
Page	103	104	105	106



■ Thyristor Power Regulators





Type	3-Phase Power Regulator	Small single-phase power regulator		Small 3-phase power regulator
Model	TPR-3	TPR-2G	TPR-2M	TPR-3M
Appearance				
Features	· Status indication with 9 LEDs · Various alarm functions · Soft start / Soft down · Built-in fast fuse	· TPR-2N compliant · An economical price · Slim Size · Phase Control, Cycle Control (Order Specification) · Various alarm verification functions (50A/70A only)	· Several protection functions (heater break, overcurrent, heat sink overheating, SCR short circuit, etc) · Improved safety by of circuit power supply and load power supply separation (free voltage) · SOFT START(60sec), SOFT UP/DOWN(15sec)	· 110 mm (width) small 3-phase slim type thyristor power regulators · Improved safety with the separate power supply · 4 LEDs to check operation status and alarm · Several alarm functions. "Caution" and "warning" alarm separation.
Power voltage	220 V a.c., 380 V a.c. / 440 V a.c.	220 V a.c. 50/60 Hz, 380 V a.c. 50/60 Hz	100-240 V a.c. 50/60 Hz, 100-440 V a.c. 50/60 Hz	100-240 V a.c. 50/60 Hz
Rated current	200 A, 250 A, 320 A, 500 A	25 A, 35 A, 50 A, 70 A	25 A, 35 A	25 A, 45 A
Control type	Phase control, ON/OFF control	Phase control (Shipment Mode), Fixed cycle control(Optional), Variable cycle control(Optional)	Phase control (standard), Variable cycle control (optional)	Phase control, Fixed cycle control (Option) Variable cycle control (Option)
Page	107	108	109	110

Selection Table



Type	Slim Type Single-Phase Thyristor Power Regulators	3-Channel Each Phase Control Thyristor Power Regulators		Slim Type 3-Phase Thyristor Power Regulators
Model	TPR-2SL	TPR-3SL-EP	TPR-3CH-EC	TPR-3SL
Appearance		 NEW	 NEW	
Features	<ul style="list-style-type: none"> Alarm output divided into caution and warning Several Control types available depending on load Several protection functions Improved safety by of circuit power supply and load power supply separation (free voltage circuit) 	<ul style="list-style-type: none"> 3 individual phase controls available in one product Setting and monitoring with RS485 communication Load input power single-phase, and 3-phase available. Free voltage available (100-440 V a.c) Several protection functions 	<ul style="list-style-type: none"> 3 individual phase controls available in one product Set up and monitor with Ether CAT communication Load input power single phase, all three phases possible Various protection features 	<ul style="list-style-type: none"> The slimmest type among 3-phase thyristor power regulators under the same rating (110 mm) The heat sink excellent design and several protection circuits provide high durability. Improved safety with the separation of circuit power supply and load power supply Several alarm functions
Power voltage	100-240 V a.c. 50/60 Hz, 380-440 V a.c. 50/60 Hz	100-240 V a.c. 50/60 Hz, 100-440 V a.c. 50/60 Hz		100-240 V a.c. 50/60 Hz, 380-440 V a.c. 50/60 Hz
Rated current	40 A, 55 A, 70 A, 90 A, 110 A, 130 A, 160 A, 200 A	40 A, 55 A, 70 A, 90 A, 130 A, 160 A		
Control type	Phase control, cycle control, ON/OFF control (dip switch selection)	Phase control, fixed cycle control, variable cycle control, ON/OFF control		
Page	111	112	113	114

■ Solid State Relays



Type	Single-phase contactless relay	Single-Phase Solid State Relays For PCB Substrate
Model	SSR-2C	HSR-PD
Appearance	 NEW	
Features	60 °C / 80 °C Temperature detection prevents overheating	<ul style="list-style-type: none"> High insulation between input and output Compact, lightweight, with large capacity High reliability as non-contact Zero cross switching
Input voltage	4-32 V d.c.	4-32 V d.c.
Rated load current	25 A, 40 A	3 A, 5 A
Load voltage	90-264 V a.c. 50/60 Hz	90-240 V a.c. 50/60 Hz
Page	115	127

Type	Single-Phase Solid State Relays		3-Phase Solid State Relays	
Model	SSR-2	HSR-2	SSR-3	HSR-3
Appearance	 NEW		 NEW	
Features	<ul style="list-style-type: none"> Terminal protection cover for safety Operation check by operation indicator (red LED) Zero cross switching/ random switching 	<ul style="list-style-type: none"> High insulation between input and output High reliability as non-contact C-R Snubber, Zero cross switching 	<ul style="list-style-type: none"> Terminal protection cover for safety Operation check by operation indicator (red LED) Zero cross switching / random switching 	<ul style="list-style-type: none"> High insulation between input and output High reliability as non-contact C-R Snubber, Zero cross switching
Input voltage	4.6-32 V d.c., 70-264 V a.c.	4-32 V d.c., 90-264 V d.c.	4.6-32 V d.c., 70-264 V a.c.	4-32 V d.c., 90-264 V d.c.
Rated load current	10 A, 20 A, 30 A, 40 A	10 A, 20 A, 30 A, 40 A, 50 A, 70 A	10 A, 20 A, 30 A, 40 A	10 A, 20 A, 30 A, 40 A, 50 A, 70 A
Load voltage	Low pressure : 90-264 V a.c. 50/60 Hz,		High pressure : 90-480 V a.c. 50/60 Hz	
Page	116	118	120	122

Selection Table

Type	Slim Type Single-Phase Solid State Relays	2-Wire Cutoff Solid State Relays	Slim Type 3-Phase Solid State Relays
Model	HSR-SL	HSR-2SLD	HSR-3SL
Appearance			
Features	<ul style="list-style-type: none"> · 22.4 mm Slim Type · Load voltage 90 - 264 V a.c. / 90 - 480 V a.c. · High insulation between input and output · C-R Snubber, Zero cross switching 	<ul style="list-style-type: none"> · Status indication with several LED displays · Control each phase simultaneously with the 2-wire disconnection function · When the temperature of heat sink is 60 °C / 80 °C, the alarm output works and operation stops · It has the mandatory functions required from FPD industry 	<ul style="list-style-type: none"> · Improved safety and working convenience with the heat sink one-body type · Can be installed in small spaces with the small design · It is the slimmest type among the 3-phase solid state relays under the same rating (79 mm)
Operating voltage range	4-32 V d.c.		
Rated load current	15 A, 25 A, 40 A	25 A, 40 A	15 A, 25 A, 40 A
Load voltage	Low pressure: 90-264 V a.c. 50/60 Hz, High pressure: 90-480 V a.c. 50/60 Hz		
Page	124	125	126

■ Power Supplies

Type	DIN Rail Type Power Supplies	Enclosed type Power Supplies	Small Rail Type				
Model	DPS	TPS	HNPS				
Appearance							
Features	<ul style="list-style-type: none"> · 35 mm width DIN Rail installation method · Low output voltage fluctuation · High efficiency and low heat generation · Overcurrent, overvoltage, overheating protection functions 	<ul style="list-style-type: none"> · Input inrush current limit · Output voltage adjustable volume · Overcurrent/overvoltage/short circuit protection/overheating protection 	<ul style="list-style-type: none"> · Easy Rail Installation (DIN) · Output Voltage Variable · Overcurrent Protection · Input Inlet Current Limit 				
Power output	<table border="1"> <tr> <td>1output</td> <td>15 W, 30 W, 50 W,</td> </tr> <tr> <td>2output</td> <td>75 W, 100 W, 120 W, 180 W, 216W, 240 W</td> </tr> </table>	1output	15 W, 30 W, 50 W,	2output	75 W, 100 W, 120 W, 180 W, 216W, 240 W	15 W, 30 W, 50 W, 75 W, 100 W 55 W, 100 W, 150 W, 220 W, 230 W, 350 W, 450 W	3 W, 7.5 W -
1output	15 W, 30 W, 50 W,						
2output	75 W, 100 W, 120 W, 180 W, 216W, 240 W						
Input voltage	100-240 V a.c., 100-120 V a.c., 200-240 V a.c.		100-240 V a.c. 50/60 Hz				
Output voltage	5 V, 12 V, 15 V, 24 V, 48 V	5 V, 12 V, 15 V, 24 V, 48 V, 24/05 V, 24/12 V, 24/24 V	5 V, 12 V, 15 V, 24 V				
Voltage fluctuation range	± 5 ~ 10 % (According to internal VR)		±10 % (Variable by volume : V.ADJ)				
Protection circuit	Overcurrent, overvoltage, overheating, output short-circuit protection		Overcurrent protection				
Dielectric strength	2,700 V a.c. 1 min (Input - Output)		3 kVAC (Input - Output to), 1.5 kVAC (Input - Between FG), 500 V a.c. (Output to FG), (Detection current : 10 mA, to 1 min)				
Page	129	128	130				



■ Control Switches

Type	Ø 22, Ø 25, Ø 30 Advanced LED Switch	Ø 25, Ø 30 Affordable LED Switch	Ø 16, Ø 22 Small LED Switch
Model	MR	CR	DR
Appearance			
Features	<ul style="list-style-type: none"> · 3 aluminum guard and 2 plastic guard types provide wide configuration possibilities · Double break snap action open / close contacts with self-diagnosis function for high contact reliability 	<ul style="list-style-type: none"> · 1a1b one-body type · Long life with the bright LED light source · Convenient product configuration with the modular actuators and contacts · High contact reliability with the slow-make contact point and self-diagnosis function 	<ul style="list-style-type: none"> · 1a1b one-body type · Long life with the bright LED light source · The control and contact parts are modular and convenient to configure the product.
Type	Push buttons, illuminated push buttons, pilot lamps, selectors, key selectors, illuminated selectors, emergency switches, illuminated emergency switches, buzzers	Push buttons, illuminated push buttons, pilot lamps, selectors, key selectors, emergency switches	Push buttons, illuminated push buttons, pilot lamps, selectors, key selectors, illuminated selectors, emergency switches, illuminated emergency switches
Power voltage	100-240 V a.c. 50/60 Hz, 380 V a.c. 50/60 Hz, 12-24 V a.c. 50/60 Hz or 12-24 V d.c.		100-240 V a.c. 50/60 Hz, 12-24 V a.c. 50/60 Hz or 12-24 V d.c.
Dielectric strength	2,000 V a.c. for 1 min	1,500 V a.c. 60 Hz for 1 min	1500 V a.c. 50/60 Hz for 1 min
Page	135	133	131



Control Switches

Type	Ø22, Ø25 Combined LED Switch
Model	AR
Appearance	
Features	<ul style="list-style-type: none"> Elegant European design Easy to attach and detach actuators and contacts Ø22, Ø25 Dual usage
Type	Push buttons, illuminated push buttons, pilot lamps, selectors, illuminated selectors, key selectors, emergency switches
Power voltage	110 V a.c. 50/60 Hz, 220 V a.c. 50/60 Hz
Dielectric strength	2,000 V a.c. for 1 min (among pole terminals)
Page	137



Combination Display Lights

Type	LED Square Indicators	LED Combination Display Lights
Model	CR40	CDN
Appearance		
Features	<ul style="list-style-type: none"> Display surface size 40 X 32 mm Bright LED light source Convenient individual mounting, gathered / assembled mounting Gathered / assembled mounting by the + appearance connector (Die casting) 	<ul style="list-style-type: none"> Display surface size 30 X 30 mm, 30 X 40 mm 2 Type 6 Indicating colors Simple assembling. Able to change the colors on the spot Max. 200 compositions (10 rows, 20 columns)
Power voltage	100-240 V a.c. 50/60 Hz, 380 V a.c. 50/60 Hz, 12-24 V d.c.	110/220 V a.c. 50/60 Hz, 24 V a.c. 50/60 Hz or 24 V d.c.
LED Display Color	Red, green, yellow, blue, white	Red, green, yellow, white, orange, blue
Dielectric strength	1,500 V a.c. for 1 min	2,000 V a.c. for 1 min
Page	138	

Power Switches

Type	Power Switches	
Model	HY-500	BE
Appearance		
Features	<ul style="list-style-type: none"> Directly turn ON/OFF the power of compact electric motor Exposed type/flush type, plastic/cold rolled steel case Push buttons for turning ON/OFF electric motors (forward, reverse operations) Lamp power ON/OFF switch mounting type Electrical appliances safety certification 	<ul style="list-style-type: none"> Directly turn ON/OFF the power of compact electric motor Exposed type/flush type, plastic/cold rolled steel case Push buttons for turning ON/OFF electric motors (forward, reverse operations) Waterproof non-flammable ABS Plastic Case
Rated capacity	250 V a.c. 15A	440 V a.c. 15 ~30 A
Display legends	ON, OFF, FOR, STOP, REV	
Case material	Cold rolled steel case, Plastic	Cold rolled steel case, Non-flammable ABS
Page	139	

Cam Switches



Type	Cam switches	
Model	HY-SQ5/255/305/MRK	SQ4
Appearance		
Features	<ul style="list-style-type: none"> HY-SQ5 /305/255 series Several surfaces (square, Ø25 round, Ø30 round) Switch-board switch A/S, V/S, C/S standard manufacturing product Machine tools and electrical installation custom circuit configurations for every industry HY-MRK Handle lock function by key lock Rated current 20 A, high capacity cam switches/custom circuit configuration 	<ul style="list-style-type: none"> Small Cam switches (48 X 48 mm) 2 operation handles (H type, R type) Ammeter switch (AS), Voltmeter switch (VS) Small cam switches with several circuit configurations
Rated insulation voltage	600 V	690 V a.c.
Rated current	10 A	16A-24 V a.c., 8A-48 V a.c., 5A-110 V a.c., 3A-220 V a.c., 1.8A-380 V a.c.
Dielectric strength	2,500 V a.c. for 1 min	
Page	141	140

Main Switches



Type	Main Switches
Model	MAS
Appearance	
Features	<ul style="list-style-type: none"> Designed as rapid switching structure for excellent contact reliability Lock ring applied in the OFF state Handle and contact parts with detachable structure (MAS-025) 2 color types of handle and handle guard (red/yellow and black/white) Ø22, Ø30 (MAS-025), 4 holes fixed panel mounting Clear indication of ON/OFF contact status (turning OFF the operation handle will block all contacts)
Rated insulation voltage	690 V a.c.
Rated current	25 A, 63 A, 125 A
Materials	Non-flammable
Page	140

Selection Table

■ Limit Switches

Type	Aluminum Die Casting	Zinc Die Casting	Plastic Case
Model	HY-M900	HY-L800	HY-LS800
Appearance			
Features	<ul style="list-style-type: none"> · Solid die casting case and 2 circuits double micro switch built-in · High mechanical intensity with the heat resistant, oil proof and dust protection structure · Check the operation state on the outside with the operation indicator 	<ul style="list-style-type: none"> · Zinc die casting body and plastic cover structure · 4 actuator types provide wide selection possibilities · Applicable to machine tools, transportation machines, assembling lines and several industrial machines 	<ul style="list-style-type: none"> · Compact size and lightweight with the plastic case · The plastic case is safe against electric leakage · 6 actuator types provide wide selection possibilities
Open/close frequency	Mechanical: 120 times/min, electrical: 20 times/min	Mechanical: 120 times/min, electrical: 30 times/min	
Insulation resistance	Min. 100 MΩ (500Vd.c.)		
Dielectric strength	Among terminals : 1000 V a.c. 50/60 Hz for 1 min, Among unfilled metal parts : 1500 V a.c. 50/60 Hz for 1 min	Among terminals : 1500 V a.c. 50/60 Hz for 1 min, Among unfilled metal parts : 2000 V a.c. 50/60 Hz for 1 min	1,000 V a.c. 50/60 Hz for 1 min, 2,000 V a.c. 50/60 Hz for 1 min
Page	142		143

■ Micro Switches

Type	Micro Switches	
Model	HY-700	ZCN-500
Appearance		
Features	<ul style="list-style-type: none"> · Certain operation and long life with the snap action tool · Excellent repetitive accuracy and 10 A open/close capacity · Standard type, installation hole gap: 25.4 mm, fixed with M4 bolt · 9 actuator types provide wide selection possibilities · Terminal protective cover (optional) 	<ul style="list-style-type: none"> · Certain operation and long life with the beryllium copper and running spring to the strong chemically resistant resin case. · Compact, lightweight, with strong mechanical durability · 9 Actuator types provide wide selection possibilities
Open/close frequency	Mechanical: 120 times/min, Electrical: 20 times/min	
Insulation resistance	Min. 100 MΩ (500 V d.c.)	
Rated current	10 A 250 V a.c.	
Page	144	143

■ Foot Switches

Type	Foot Switches
Model	HY-100
Appearance	
Features	<ul style="list-style-type: none"> · High mechanical safety with the aluminum case · Micro switch with excellent electrical reliability built-in · Protective cover from falling materials and safety latch lever attached. (HY-104) · Cable locker applied (HY-103, 104) · Cost-effective plastic case (HY-101)
Rated current	10 A 250 V a.c.
Foot switch materials	Plastic, aluminum
Contact structure	C Contact
Page	145



■ Mono Lever Switches



Type	Mono Lever Switches
Model	LEL/LES
Appearance	
Features	<ul style="list-style-type: none"> · 4-direction switches that can operate 4 directions in a single lever · The lever tilting direction minimizes malfunctions during use and it is suitable for products that are frequently switched in direction. · There are auto returning, manual returning and mixed types depending on lever operation type.
Rated insulation voltage	600 V
Rated electric current	3 A 250 V a.c.
Dielectric strength	2,500 V a.c. for 1 min
Page	145

■ Pendant Switches

Type	Pendant Switches
Model	HY-P series
Appearance	
Features	<ul style="list-style-type: none"> · Easy wiring and operation with the wire holder bending structure (15°) · Solidity improved with the thicker high impact ABS resin, and anti-slip structure · The wide internal wiring space makes wiring easier and more convenient · Several new features on-demand (LED, volume, toggle switch).
Degree of protection	IP-65 (IEC 60529) (emergency switch type included)
Materials	Case : high impact ABS, Contacts : AgSnO2
Insulation resistance	Min. 100 MΩ (500 V d.c.)
Page	146

■ Sign Towers

Type	Ø25 Modular LED Sign Towers		Ø60 Modular LED Sign Towers		Ø55 Sign Towers	
Model	STE025		STE060		HY-TN	
Appearance						
Feature	<ul style="list-style-type: none"> · Ø25 column type, suitable installation structure for small machines and narrow spaces · Long life with high brightness LED light source · 1~3 stacks and 3 color types · Easy installation with pipe direct installation structure 		<ul style="list-style-type: none"> · Long life with the high brightness LED light source · Simple structure from 1 to 5 stacks · Several mounting supporters · Convenient configuration (number of stacks and colors) with the modular type 		<ul style="list-style-type: none"> · Ø55 round type · 1~5 stacks and 5 color types · Incandescent bulb type 	
Function	Continuous light only		Continuous light, continuous light/flashing/buzzer (selection by external signal)			
Diameter	Ø25		Ø60		Ø55	
Supporter	L type bracket (sold separately)		Plastic round supporter, L type bracket, elbow type supporter (optional)		Plastic round supporter, L type bracket, elbow type supporter (optional), Plastic supporter with pipe connection	
Rated voltage	24 V d.c.		24 V d.c., 100-240 V a.c. 50/60 Hz		24 V d.c., 220 V a.c. 50/60 Hz	
Number of stacks & colors	1~3 stacks (red, green, yellow)		1~5 stacks (red, green, yellow, blue, white)			
Page	153		152		151	

Type	Ø40, Ø60, Ø80 LED Sign Towers		Ø25, Ø40, Ø60, Ø80 LED Sign Towers	
Model	STS		STL	
Appearance				
Features	<ul style="list-style-type: none"> · Several sizes (Ø40, Ø60, Ø80) · Long life with the high brightness LED light source · 1~5 stacks and 5 color types · 3 installation types 		<ul style="list-style-type: none"> · Several sizes (Ø25, Ø40, Ø60, Ø80) · 1~5 stacks and 5 color types · Convenient installation with the aluminium pipe direct installation structure 	
Function	Continuous light only		Continuous light/flashing/buzzer models (selection by external signal)	
Diameter	Ø40, Ø60, Ø80		Ø25, Ø40, Ø60, Ø80	
Supporter	Plastic round supporter, L type bracket, elbow type supporter (optional)		Plastic round supporter, L type bracket, elbow type supporter (optional)	
Rated voltage	24 V a.c. 50/60 Hz or 24 V d.c., 12 V a.c. 50/60 Hz or 12 V d.c. (Order-made)		24 V d.c., 24 V a.c. 50/60 Hz or 24 V d.c., 100-240 V a.c. 50/60 Hz	
Number of stacks & colors	1~5 stacks (red, green, yellow, blue, white)			
Page	149		150	

■ Indicating Lights



Type	LED Wall Mounted Lights	
Model	WME	WMS
Appearance		
Features	<ul style="list-style-type: none"> · 3-color slim type, suitable for wall mounting · Long life with the high brightness LED light source · 2 body type: beige or chrome plated · Continuous light, flashing light, 2-melody buzzer built-in · Degree of protection IP54 (IEC 60529) 	<ul style="list-style-type: none"> · 1~5 stacks, suitable for wall mounting · Long life with the high brightness LED light source · 2 types of buzzer melodies (single melody/beeping) · Continuous light, flashing light · Degree of protection IP54 (IEC 60529)
Rated voltage	24 V a.c. 50/60 Hz or 24 V d.c., 12 V a.c. 50/60 Hz or 12 V d.c. (Order-made)	
Functions	Continuous light · flashing · buzzers	
Number of stacks and colors	3 Tires Red, Green, Yellow	1~5 Tires Red, Green, Yellow, Blue, White
Page	154	

■ Panel lamp

Type	LED Basic Panel Lamp
Model	HL
Appearance	
Features	<ul style="list-style-type: none"> · Easy to install in tight spaces · Protection from obstruction through an internal protection circuit. · Improved cost-effectiveness through non-insulated SMPS methods · High Efficiency LED Recruitment (using LG Innotec G3 series LEDs)
Rated voltage	220 V a.c.
Number of stacks and colors	Light Color
Page	153

Selection Table



■ Turn Lights

Type	Signal Lights (Xenon)	Ø84 LED Signal Lights	Ø70 LED Signal Lights
Model	RLA-WX/WXB	LT	SLB
Appearance			
Features	<ul style="list-style-type: none"> · Ø118 Rotating continuous light only, rotating continuous light and buzzers built-in · Excellent instant light emitting and high brightness · Less current consumption compares to the rotating light and 4 times longer life expectancy compared to the regular lamp · Simple attaching/detaching due to the permanent magnet attachment type (for cars) · Degree of protection IP54 (IEC 60529) 	<ul style="list-style-type: none"> · Rotational flickering function by the sequential flashing · Long life with the high brightness LED light source · Ø84 round cap, direct or supporter mounting · Acrylic cap for excellent visible light transmittance · Solid and smart design · Degree of protection IP54 (IEC 60529) 	<ul style="list-style-type: none"> · Continuous light, flashing light, buzzer (selection by external signal) · Long life with the high brightness LED light source · Select Ø70 round type cap, rectangular type cap, direct installation, supporter mounting installation · Cost-effective, simple installation structure · Solid polycarbonate protective cap · Degree of protection IP54 (IEC 60529)
Diameter	Ø118	Ø84	Ø70
Rated voltage	110 V a.c. 50/60 Hz, 220 V a.c. 50/60 Hz, 12 V d.c., 24 V d.c.	12-24 V a.c. 50/60 Hz, 110/220 V a.c. 50/60 Hz, 12-48 V d.c.	12 V a.c. 50/60Hz or 12 V d.c., 24 V a.c. 50/60 Hz or 24 V d.c., 110-240 V a.c. 50/60 Hz
Functions	Rotating continuous light · buzzers	Rotating continuous light · Flashing · Buzzer built-in	Lit, flashing, buzzer (selected by external input signal)
Colors	Red, blue, white	Red, yellow, green, blue	Red, yellow, green
Page	156	157	



■ Warning Lights

Type	Ø60 / Ø84 / Ø100 / Ø150 Revolving Warning Lights					
Model	T060 / T084	T060 / T084	T060 / T084 T100 / T150	T060 / T084 / T100	T060 / T084 T100 / T150	T060 / T084 / T100
Appearance						
Features	<ul style="list-style-type: none"> · Ø60 / Ø84 / Ø100 / Ø150 Rotating continuous light, rotating continuous light and buzzers · High luminance LED light source bright and long life · Several supporter mounting type · Cost-effective, simple installation structure · Solid polycarbonate protective cap · Rotational structure with the excellent abrasion resistive acetal gear · Degree of protection IP54 					
Diameter	Ø60, Ø84, Ø100, Ø150					
Rated voltage	● 12 V d.c. : 0.08 A, ● 24 V d.c. : 0.06 A, ● 110 - 220 V a.c. : 0.03 A			● 12 V d.c. : 0.09 A, ● 24 V d.c. : 0.07 A, ● 110 - 220 V a.c. : 0.04 A		
Functions	Rotating continuous light · buzzers					
Colors	Red, Yellow, Green, Blue					
Page	155					

■ Buzzers

Type	Power Buzzers	4-Tone Buzzers	3-Tone Electronic Buzzers
Model	HY-256/306/606/606N	HY-606MD/MA	HY-226M/256M
Appearance			
Features	<ul style="list-style-type: none"> · Compact size, lightweight, high capacity buzzer melody · Excellent alarm function · Suitable for panel installation · Low Power consumption 	<ul style="list-style-type: none"> · Compact, light weight, high capacity tones · Low Power consumption and long life expectancy · Simple installation structure with the panel installation type 	<ul style="list-style-type: none"> · Compact, lightweight, with 3 melodies · Front LED illuminates during buzzer operation · Simple installation structure with the panel installation type · Low Power consumption
Rated voltage	110 V a.c. 50/60 Hz, 220 V a.c. 50/60 Hz, 12 V d.c., 24 V d.c.	110 V a.c. 50/60Hz, 220 V a.c. 50/60 Hz 12d.c., 24 V d.c.,	100-240 V a.c. 50/60 Hz, 12 V d.c., 24 V d.c.
Power consumption	4 VA, 8 VA, 30 mA	2.5 W	0.6 W, 13.5 W
Volume (1 m distance)	85 dB max	98 dB max	80 dB max
Page	158		

■ Terminal Blocks

Type	Assembly Terminal Blocks		Fixing Type Terminal Blocks
Model	HYBT-15A2	HYTM	HYT
Appearance		 NEW	 NEW
Features	<ul style="list-style-type: none"> · DIN rail installation structure · Possible to assemble the terminal block with different capacity to the same fixing plate · Excellent attaching / detaching of terminal at the temporal position 	<ul style="list-style-type: none"> · New design (simple and robust image) · Contact protective structure for the terminal block live parts · O-type and Y-type crimp terminal use more convenient with the screw self-up structure · Din Rail one-touch assemblable and detachable structure (using slotted screwdriver during removal) 	<ul style="list-style-type: none"> · Several polarities for each current capacity, easy selection · Body made of phenolic resin (60 - 500 A) and ABS flame retardant resin (10 - 30 A) · Because the bolt and plate underwent heat treatment and rust-proof treatment, it has excellent electrical and mechanical characteristics · Standard product of rated current · Simple installation
Rated insulation voltage	600 V		
Rated current	15 A	15 A, 25 A, 35 A, 60 A, 100 A	10 A, 20 A, 30 A, 60 A, 100 A, 150 A, 200 A, 300 A, 400 A, 500 A
Insulation resistance	Min. 100 MΩ (between each charging part and between each charging part and mounting metal plate)		
Page	159		161

■ Fuse Holders

Type	Fuse Holders
Model	HY-F15/HY-F30
Appearance	
Features	<ul style="list-style-type: none"> ● HY-F15 series <ul style="list-style-type: none"> · LED continuous light indication during fuse disconnection / safety cover installation structure · DIN rail and bolt fixing structure / Easy installation by 1P, 2P, 3P individual products ● HY-F30 series <ul style="list-style-type: none"> · Body materials are made of NYLON66 with glass fiber and have excellent electrical insulation, strong against impact and heat · The fuse comes out when replacing it, which provides excellent safety
Rated current	250 V a.c. 15 A, 24 V d.c. 10 A, 600 V a.c. 30 A
Remarks	110-220 V a.c., 12-24 V d.c., 110-600 V a.c.
Page	162

■ Cable Connectors

Type	Cable Connectors
Model	HYC-M1/HYC-M2
Appearance	
Features	<ul style="list-style-type: none"> · Applied as waterproof and spinning-proof when extending the cable from many machine tools · PF 1/2 cover fixing type nut · Nut tightening structure by the seal rubber and stuffing washer
Materials	PC (Resin)
Remarks	Ø8, Ø11
Page	162

■ Control Boxes





Type	Control Boxes
Model	HY-25/HY-30
Appearance	 UPGRADE
Features	<ul style="list-style-type: none"> · Rolled iron and ivory color enamel painted · Several operating switches attached (Ø25 and Ø30) · Several specifications (1 ~ 6 holes)
Materials	Rolled steel
Remarks	Ø25, Ø30
Page	162

TEMPERATURE CONTROLLER

VX series



Specifications

Model		VX9	VX2	VX7	VX4	
Appearance						
W×H×D(mm)		96.0 × 96.0 × 63.0	48.0 × 96.0 × 63.0	72.0 × 72.0 × 63.0	48.0 × 48.0 × 63.0	
Input	Thermocouple	K, J, E, T, R, B, S, L, N, U, W, PLII				
	Reference junction compensation accuracy	±1.5 °C (within -10 ~ 50 °C)				
	RTD	JPT100, PT100				
	Allowable line resistance	Each 3 wire within 10 Ω (However, the resistance between the three lines shall be the same.)				
	DC voltage / current	1 ~ 5 V (4 ~ 20 mA), 5 V (0 ~ 20 mA), 0 ~ 10 V, 0 ~ 50 mV, 0 ~ 100 mV				
	Sampling cycle	50 ms				
Control output	Relay output	<ul style="list-style-type: none"> Rated switching capacity : 5A 250 V a.c., 5 A 30 V d.c. Max. switching voltage : 250 V a.c., 110 V d.c. Mechanical life : 2 million times (at 180 CPM) Max. switching power : 750 VA, 90 W Max. switching current : 5 A 				
	SSR output	12 V d.c. ± 1 V d.c. pulse voltage (Load resistance min. 600 Ω)				
	SCR output	4 ~ 20 mA ±0.2 % of FS ±1 digit, Load resistance min. 600 Ω				
Control	Control type	ON/OFF, PID control, 2DOF PID control				
	Output operation	Reverse action, direct action				
Memory	Non-volatile memory life	<ul style="list-style-type: none"> EEPROM unlocked : when setting E2P.L: OFF in G.SET group - EEPROM life: 1 million times write guaranteed, EEPROM lock setting: when setting E2P.L: ON in G.SET group - store in RAM 				
Display	Display method	Wide viewing angle LCD				
USB Loader	Communication method	USB 2.0				
	Protocol	Protocol : PC-LINK	Baudrate : 38400 bps	Start bit : 1 bit	Data bit : 8bit	
	Communication distance	Max.5 m				
Option	Auxiliary Output	Relay 1 to 4 points, rated switching capacity : 5A 250 V a.c., 5 A 30 V d.c.				
	DI	2 or 4 points <ul style="list-style-type: none"> Enter the junction: ON: 1 KE or less, OFF: 100 KΩ or higher Outflow current: approximately 2 mA per input Enter contactless point: ON: 1.5 V max., OFF: 0.1 mA max. Open state voltage: approximately 5 V d.c. 				
	Transmission Output	1 point, 4 to 20 mA ±0.2% of FS ±1 digit, load resistance: not more than 600 Ω				
	Remote input	1 contact, 4 ~ 20 mA (1 ~ 5 V)				
	Current input	1 contact or 2 contacts, 0.0 - 50.0 A, CT-70 Current Detector (Salar Sale)				
	RS-485	Communication method	EIA RS485 standard, 2-wire half-duplex			
		Max. connections	31 (Address setting 1~99 available)			
		Communication sequence	No sequence			
		Communication distance	Within 1.2 km			
		Communication speed	4800, 9600, 14400, 19200, 38400, 57600 BPS			
Bit		<ul style="list-style-type: none"> Start bit : 1 bit Data bit : 7 or 8 bit Parity bit : NONE / EVEN / ODD Stop bit : 1 or 2 bit 				
Power	AC Power-On Voltage	100-240 V a.c. 50/60 Hz				
	DC Power-On Voltage	24 V d.c., Class2				
	Voltage fluctuation rate	±10 % of power voltage				
	Insulation Resistance	Min. 20 MΩ, 500 V d.c.				
	Voltage Resistance	3,000 V a.c. 50/60 Hz 1 minute (between primary and secondary terminals)				
	AC Voltage-type power consumption	9.0 VA or less	8.5 VA or less	8.5 VA or less	8.5 VA or less	
	DC Voltage-type power consumption	3.2 W or less	2.7 W or less	2.8 W or less	2 W or less	
	Ambient temperature & humidity	-10 ~ 50 °C, 35 ~ 85 % RH (without condensation)				
	Storage temperature	-25 ~ 65 °C				
	Ambient	 <ul style="list-style-type: none"> Electrostatic Discharge(ESD) : KN61000-4-2 Conductive RF(CS) : KN61000-4-6 EFT(RS) : KN61000-4-3 SURGE : KN61000-4-5 				
Weight (g)	IP65 (The front part)	IP65 (The front part)	IP65 (The front part)	IP66 (The front part)		
	290	202	194	120		
Components	BODY, FIXED BRACKET, RESISTANCE 250 Ω (1%), RUBBER PACKING, HANDLING INSTRUCTIONS					

Suffix code

Model	Code										Content
VX	<input type="checkbox"/>	<input type="checkbox"/>	<input type="checkbox"/>	<input type="checkbox"/>	<input type="checkbox"/>	<input type="checkbox"/>	<input type="checkbox"/>	<input type="checkbox"/>	<input type="checkbox"/>	<input type="checkbox"/>	LCD Digital Temperature Controller
Size	2										48(W) × 96(H) × 63(D) mm
	4										48(W) × 48(H) × 63(D) mm
	7										72(W) × 72(H) × 63(D) mm
	9										96(W) × 96(H) × 63(D) mm
Sensor	U										Universal input
OUT 1 (Control Output 1)	M										Relay
	S										SSR
	C										SCR
OUT 2 (Control Output 2)	N										None
	M										Relay
Power	A										100-240 V a.c. 50/60 Hz
	D										24 V d.c., Class2
Sub output	A1										Relay 1 (VX4 standard)
	A2										Relay 2 (VX2, VX7, VX9 standard)
	A3										Relay 3 (※ *1,*2)
	A4										Relay 4 (※ *2)
Communication											None
	C										RS-485
Retransmission output (RET)											None
	T										4 ~ 20 mA
Digital Input (DI)											None
	D2										2 Contacts (DI 1 ~ 2)
	D4										4 Contacts (DI 1 ~ 4)
Current Detection Input (CT)											None
	H1										CT 1
	H2										CT 2
Remote input (REM)											None
	R										4 ~ 20 mA (1 - 5 V)

※ *1) You cannot select from VX4. However, if OUT2=M is selected, SUB3 is available depending on the setting of the parameter.
 ※ *2) You can select from VX2, 7, 9 (VX4 is excluded)
 ※ The orderable name configuration of the VX is available in the User's Guide, Catalog, Please refer to our website.

※ Separate
 - Current Detector: CT-70
 - USB Loader Cable: NMC-UM210
 - Terminal Protection Cover

VX2	VX4	VX7	VX9
TC2A-COV	TC4A-COV	TC7A-COV	TC9A-COV

New product

High function

Programmable Temperature Humidity

Thermal shock Test control

Multi-channel

Economy Ignorance For freezer

Indicator

Input Type INP Parameters and Input Sensor Type and Range

● Thermocouple and side temperature resistor

Classification	kind	Parameter Settings		Temperature range		Error
		Display	Communication	°C	°F	
THERMO COUPLE	K	K0	1	-200 ~ 1370	-328 ~ 2498	±0.2 % of FS ± 1 digit ±0.2 % of FS ± 1 digit 100~200 °C : ±2.0 % of FS ± 1 digit
		K1	2	-100.0 ~ 500.0	-148 ~ 932	
	J	J0	3	-200 ~ 1200	-328 ~ 2192	
		J1	4	-199.9 ~ 900.0	-328 ~ 1652	
	E	E1	5	-199.9 ~ 900.0	-328 ~ 1652	
	T	T1	6	-199.9 ~ 400.0	-328 ~ 752	
	R	R0	7	0 ~ 1700	32 ~ 3092	
	B	B0	8	100 ~ 1800	212 ~ 3272	
	S	S0	9	0 ~ 1700	32 ~ 3092	
	L	L1	10	-199.9 ~ 900.0	-328 ~ 1652	
	N	N0	11	-200 ~ 1300	-328 ~ 2372	
	U	U1	12	-199.9 ~ 400.0	-328 ~ 752	
	W	W0	13	0 ~ 2300	32 ~ 4172	
	PLII	PL0	14	0 ~ 1300	32 ~ 2372	
RTD	JPt100	JPt0	20	-200 ~ 500	-328 ~ 932	±0.2 % of FS ± 1 digit
		JPt1	21	-199.9 ~ 500.0	-328 ~ 932	
	Pt100	Pt0	22	-200 ~ 640	-328 ~ 1184	
		Pt1	23	-199.9 ~ 640.0	-328 ~ 1184	

● DC Current and Voltage

Classification	kind	Parameter Settings		Range	Error
		Display	Communication		
Current Input	4 ~ 20 mA (※)	1-5 V	30	-1999 ~ 9999	±0.2 % of FS ± 1 digit
	0 ~ 20 mA (※)	5 V	31		
VDC / mVDC	1 ~ 5 V	1-5 V	30		
	0 ~ 5 V	5 V	31		
	0 ~ 10 V	10 V	32		
	0 ~ 50 mV	0.05 V	33		
	0 ~ 100 mV	0.1 V	34		

※ If direct current is used, it is recommended to use a 250 Ω (high precision of 0.1%) resistor connected in parallel to the outside of the terminal. The 250 Ω (1%) resistance enclosed in the product is not a precise resistance, so please be aware of the use.

TEMPERATURE CONTROLLER

Connectivity

● VX2

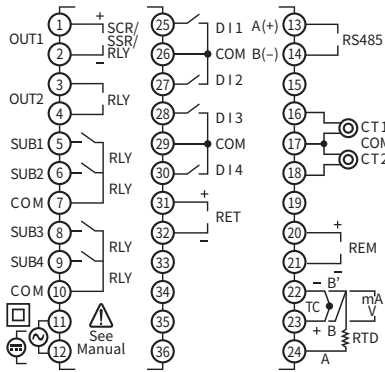

● VX4

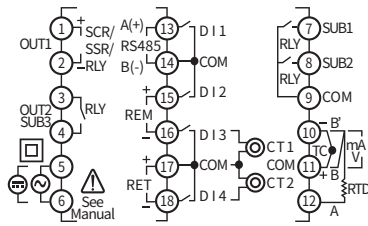

● VX7

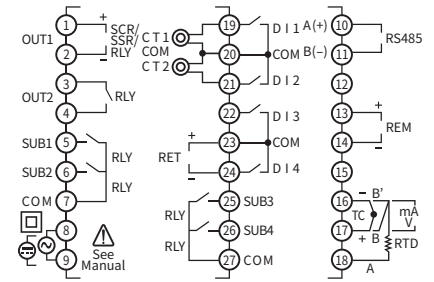

● VX9

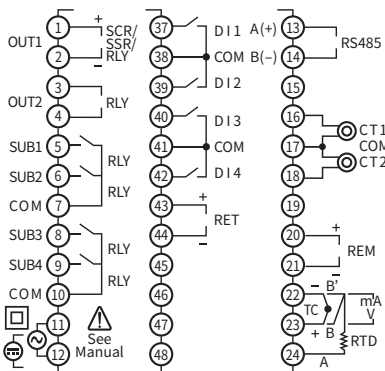

※ Use the following geometry for terminals.

[Unit : mm]

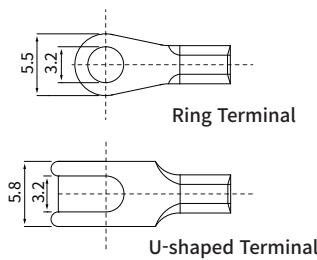

■ Racket Assembly Diagram

● VX4

● VX2, VX7, VX9

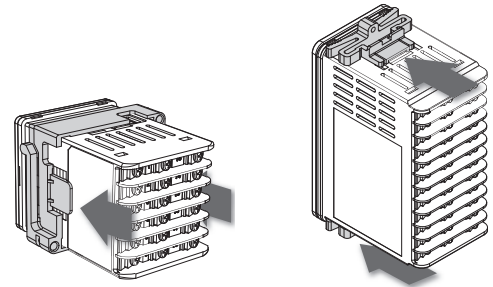

Separate

■ USB Loader Cable (NMC-UM210, ※Separate)

※ USB2.0 Mini 5PIN Cable

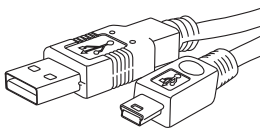

■ Current Detector (CT-70, ※Separate)

※ HBAEnable in Options
(Current ratio 1000 : 1, Current detection range 0.0 - 50.0 A)

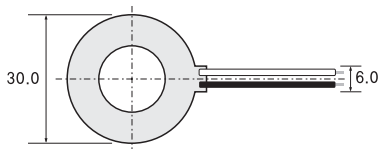

[Unit : mm]

■ Protective Cover Dimensions (※Separately)

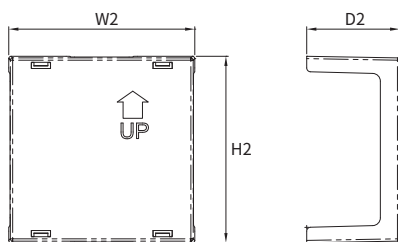

VX2	VX4	VX7	VX9
TC2A-COV	TC4A-COV	TC7A-COV	TC9A-COV

Appearance dimensions and panel processing dimensions

■ Product Appearance Dimensions

[Unit : mm]

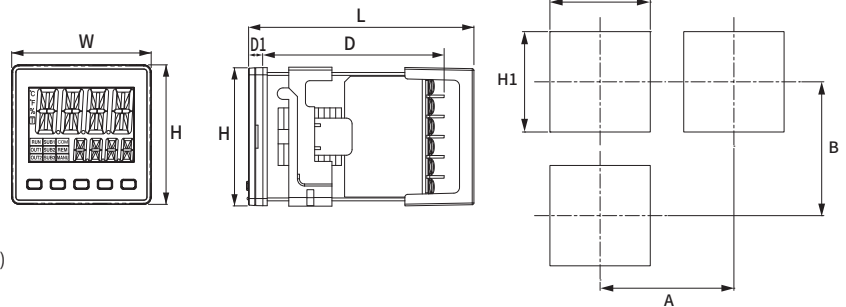





Sortation	Display	VX2	VX4	VX7	VX9
Product appearance	W	48.0	48.0	72.0	96.0
	H	96.0	48.0	72.0	96.0
	D	63.0	63.0	63.0	63.0
	D1	5.5	5.0	5.5	5.5
	L	78.4	78.4	78.4	78.4
panel processing	W1 * 1)	45.0	45.0	69.0	93.0
	H1 * 1)	93.0	45.0	69.0	93.0
	A	70.0	60.0	83.0	117.0
	B * 2)	122.0	60.0	100.0	117.0
Protection Cover	W2	48.4	48.0	71.8	96.0
	H2	94.4	48.1	71.8	96.0
	D2	26.9	24.0	26.9	26.9

* 1) +0.5 mm Apply Tolerance

* 2) Apply 100.0 mm when using USB loader cable on VX4

AX series

Specifications

Model		AX9	AX2	AX7	AX3	AX4
Appearance						
W×H×D(mm)		96.0×96.0×63.0	48.0×96.0×63.0	72.0×72.0×63.0	96.0×48.0×63.0	48.0×48.0×63.0
Input type		Multi input (Selection by internal parameters), (RTD :Pt 100 Ω, IEC 751)				
Sampling cycle		100 ms				
Input impedance		Max. 1 MΩ				
Allowable input voltage		10Vd.c. max				
Accuracy		±0.3 % of FS ±1 digit (in case of R type, ±1.0 % of FS ± 1 digit in the 0 ~ 600 °C range)				
Display		7 Segment LED (PV : Red, SV : green)				
Front size (mm)	PV	22.5×11.2	14.5×7.0	14.5×7.0	15.9×7.6	13.0×6.5
	SV	18.7×9.3	10.8×5.2	9.4×4.7	12.0×6.0	9.2×5.2
Insulation Resistance		Min. 20 MΩ, 500 V d.c for 1 min (between 1st and 2nd terminal)				
Dielectric strength		2300 V a.c. 50/60 Hz for 1 min (between 1st and 2nd terminal)				
Control type		PID control (PID control by auto-tuning), ON/OFF control, P control				
Control output operation		Direct action / reverse action (selection by parameter setting)				
Control output type	Relay output (RLY 1)		1 A contact, 3 A 240 V a.c. 3 A 30 V d.c. (resistive load) But the relay control output can be set as alarm output when not in use.			
	Voltage output (SSR)	Time-division proportional control (CYC)	12 - 15 V d.c. pulse voltage (load resistance min. 600 Ω)			
		Phase control (PHA)				
	Current output (SCR)		4 - 20 mA d.c. (load resistance max. 600 Ω)			
Power voltage		100 - 240 V a.c. 50/60 Hz (10 % of power voltage)				
Voltage fluctuation rate		±10% of power voltage				
Power consumption		Max. 5.5 VA				
Ambient temperature & humidity		- 5 ~ 50 °C, 35 ~ 85 % RH (Without condensation)				
Weight (g)		400	320	300	320	180

New product

High function

Programmable Temperature Humidity

Thermal shock Test control

Multi-channel

Economy Ignorance For freezer

Indicator

Suffix code

Model	Code	Content
AX	<input type="checkbox"/> - <input type="checkbox"/> <input type="checkbox"/>	Multi Input Digital Temperature Controller
Appearance	2	48(W) X 96(H) mm
	3	96(W) X 48(H) mm
	4	48(W) X 48(H) mm
	7	72(W) X 72(H) mm
	9	96(W) X 96(H) mm
Option	1	Relay 1 + Relay 2+SSR
	2	Relay 1 + Relay 2 + Relay 3 + SSR
	1B	SSR + Relay 1(form C) + Relay 2
	2B	SSR + Relay 1(form C) + Relay 2 + Relay 3
	3	4 - 20 mA + Relay 2
	4	4 - 20 mA + Relay 2 + Relay 3
Power	A	100-240 V a.c. 50/60 Hz

※ The relay output operates as control output, alarm output and LBA output depending on the internal parameter settings.







Range and Input Type

Sortation	Symbol	Input	Range	
			°C	°F
TC	$\mathcal{K}1$	K	- 100 ~ 1200	-148 ~ 2192
	$\mathcal{K}2$		-100.0 ~ 500.0	-148 ~ 932
	\mathcal{J}	J	-100.0 ~ 500.0	-148 ~ 932
	\mathcal{R}	R	0 ~ 1700	32 ~ 3092
	\mathcal{T}	T	-100.0 ~ 400.0	-148 ~ 752
RTD	\mathcal{Pt}	Pt100 Ω	-100.0 ~ 400.0	-148.0 ~ 752.0

TEMPERATURE CONTROLLER

NX series

Specifications

Model	NX9	NX2	NX7	NX3	NX4	NX1
Appearance						
W×H×D(mm)	96.0×96.0×100.0	48.0×96.0×100.0	72.0×72.0×100.0	96.0×48.0×100.0	48.0×48.0×100.0	48.0×24.0×100.0
Input	Thermocouple input	K, J, E, T, R, B, S, L, N, U, W, PL2				
	RTD input	Pt 100Ω, KPt 100Ω				
	DC voltage input	1-5 V d.c., -10-20 mV d.c., 0-100 mV d.c., 4-20 mA d.c. (Attach 250 Ω external resistor)				
	Input sampling cycle	250 ms				
	Input display resolution	Basically, below the measuring range decimal point				
	Input impedance	·Thermocouple and DC voltage input (mV): min. 1 MΩ, ·DC voltage input (V): approx. 1 MΩ				
	Allowable signal source resistance	·Thermocouple : max. 250 Ω ·DC voltage : max. 2 kΩ				
	Lead wire allowable resistance	RTD (max. 10 Ω. but the resistance among 3 lines should be same)				
	Allowable input voltage	Within ±10 V (thermocouple, RTD, DC voltage (mV)), within ±20 V (DC voltage (V))				
	Scaling	-1999 ~ 9999 (SL-L ~ SL-H Range)				
	Input correction	-100.0 % ~ 100.0 % of FS				
	Reference contact compensation error	±1.5 °C (15 ~ 35 °C Range), ±2.0 °C (0 ~ 50 °C Range)				
Input disconnection detection	·Thermocouple: Select OFF, UP/DOWN Scale ·Side temperature resistance: UP Scale (Current detected during thermocouple and side temperature resistance BURN-OUT: about 50 nA)					
Performance	Display accuracy	±0.5 % of FS ±1 Digit, thermocouple (K, J, E, T, R, B, S, L, U, W, PL2) ±1.0 % of FS ±1 Digit, thermocouple (N) ±0.5 % of FS ±1 Digit, RTD (KPt100 Ω, Pt100 Ω), DC voltage				
	External power supply	12 V d.c., 20 mA max. (Cannot be used when using retransmission output)				
	Insulation Resistance	·1 Blocker to 2 Blocker: 500 V d.c. 20 MΩ or higher ·1 Blocker to GROUND: 500 V d.c. 20 MΩ or higher ·2 Blocker to GROUND: 500 V d.c. 20 MΩ or higher				
	Dielectric strength	·1 Blocker to 2 Blocker : 2,300 V a.c. 50/60Hz for a minute ·1 Blocker to GROUND : 2,300 V a.c. 50/60Hz for a minute ·2Blocker to F and G : 1,500 V a.c. 50/60Hz for a minute				
Communication (Optional)	Communication method	RS-422 (4-wire), RS-485 (2-wire)				
	Protocol	PC Link STB, PC Link with Checksum, MODBUS (RTU), MODBUS (ASCII)				
	Communication speed	2400, 4800, 9600, 14400, 19200 BPS				
	Max. number of connections	31 (Address setting 1 ~ 99)				
Communication distance	Max. 1.2 km (total length)					
Control functions and output	Control method	PID auto-tuning				
	Control operation	a) reverse operation (heating) / forward operation (cooling) arbitrary selection (by parameter setting) b) simultaneous heating / cooling control				
	Setting Range	Refer to range and input code				
	Contact input (DI)	Select among 3 preset temperatures with external contact				
	Auto-tuning 2 types	Select target value / low target value auto-tuning				
	Proportional band	0.1 ~ 999.9 % (Heating / Cooling type : 0.0 ~ 999.9 %)				
	Integral time	OFF, 1 ~ 6,000 sec				
	Differential time	OFF, 1 ~ 6,000 sec				
	ARW(Anti Reset Wind-up)	Auto, 50.0 ~ 200.0 % (Proportional band)				
	ON / OFF control	Select output type by parameter				
	PID selection	Zone PID / Group PID selection				
	Manual reset	Manual reset can be set when Integral time is OFF				
Output amount at input disconnection (OUT1)	-5.0 ~ 105.0(Normal type), 0.0 ~ 105.0 %(Heating / cooling type)					
Output amount at input disconnection (OUT2)	0.0 ~ 105.0 %					
Power voltage	100-240 V a.c. (±10% of power voltage) 24 V a.c. / Vd.c.					
Power consumption	Up to 6.0 W, 10 VA or less, 8 VA (NX1)					
Ambient temperature & humidity	0 ~ 50 °C, 35 ~ 85 % RH (without condensation)					
Storage temperature	-25 ~ 70 °C					
Weight(g)	472	342	344	340	342	94

Suffix code (NX2, 3, 4, 7, 9)

Model	Code	Content
NX	<input type="checkbox"/> - <input type="checkbox"/> <input type="checkbox"/> <input type="checkbox"/>	Multi Input/Output Temperature Controller
Appearance	2	48(W) X 96(H) mm
	3	96(W) X 48(H) mm
	4	48(W) X 48(H) mm
	7	72(W) X 72(H) mm
	9	96(W) X 96(H) mm
Control type	0	Normal type (heating control)
	1	Heating / cooling control (simultaneous)
	2	Heating / cooling control (NX4-20 only)
NX9 Option	0	-
	1	RS485, HBA
NX7 Option	0	-
	1	RS485, HBA
	2	SV2, SV3, HBA
NX2, 3 Option	0	SV2, SV3
	1	HBA
	2	RS485
NX4-0 Option	0	-
	1	HBA, AL2
	2	SV2, SV3
	3	RET, RS485
	4	RS485
	5	AL1, AL2
	6	AL1, AL2, SV2
7	RS485, HBA	
NX4-1 Option	0	-
	4	RS485
NX4-2 Option	0	AL1
	4	AL1
Power voltage		100-240 V a.c. 50/60 Hz
	D	24 V d.c.

New product
High function
Programmable Temperature Humidity
Thermal shock Test control
Multi-channel
Economy Ignorance For freezer
Indicator

Note.
1: OUT1 (terminal ①-②-③) is applied as AL1
However, when selecting control output SSR/SCR6 :
OUT1 (terminal ⑥-⑦) applies as SV2
However, if relay control output

OUT2 (Terminal ⑩-⑪) applies as SSR/SCR

OUT2 (Terminal ⑩-⑪) applies as RLY

Suffix code (NX1)

(Note) NX1-1□ products can select control outputs 6, 9, 10, and 11 outputs.

Model	Code	Content
NX1-	<input type="checkbox"/> <input type="checkbox"/> <input type="checkbox"/>	Multi Input/Output Temperature Controller 48(W) X 24(H) mm
Control type	0	General type
	1	Heating/cooling control (simultaneous)
General type Option	0	Option: RET, Terminal number ④, ⑤: RET, Terminal number ⑥, ⑦: OUT1(RLY), Output Selection Initial Value: 3
	1	Option: -, Terminal number ④, ⑤: OUT1(SSR/SCR), Terminal number ⑥, ⑦: -, Output Selection Initial Value: 1
	2	Option: RS485/RET, Terminal number ④, ⑤: RET, Terminal number ⑥, ⑦: OUT1(RLY), Output Selection Initial Value: 3
	3	Option: RS485, Terminal number ④, ⑤: OUT1(SSR/SCR), Terminal number ⑥, ⑦: -, Output Selection Initial Value: 1
	4	Option: ALM, Terminal number ④, ⑤: OUT1(SSR/SCR), Terminal number ⑥, ⑦: ALM, Output Selection Initial Value: 1
	5	Option: RS485/ALM, Terminal number ④, ⑤: OUT1(SSR/SCR), Terminal number ⑥, ⑦: ALM, Output Selection Initial Value: 1
Heating/Cooling Option	0	Option: -, Terminal number ④, ⑤: OUT2(SSR/SCR), Terminal number ⑥, ⑦: OUT1(RLY), Output Selection Initial Value: 6
	1	Option: -, Terminal number ④, ⑤: OUT1(SSR/SCR), Terminal number ⑥, ⑦: OUT2(RLY), Output Selection Initial Value: 10
	2	Option: RS485, Terminal number ④, ⑤: OUT2(SSR/SCR), Terminal number ⑥, ⑦: OUT1(RLY), Output Selection Initial Value: 6
Power voltage		100-240 V a.c. 50/60 Hz
	D	24 V d.c.

* OUT1 (Heated Output), OUT2 (Cooled Output), RLY (Relay Output), SSR (Voltage Pulse Output), SCR (Current Output, 4-20mA d.c.), RET (Transmission Output)





Range and Input Type

Model	Code	Input	Range (°C)	Degree	Relative height
Thermocouple(TC)	1	K *2	-200 ~ 1370	±0.5 % of FS ±1 digit	<p>Caution</p> <p>● Measurement Input Wiring</p> <ul style="list-style-type: none"> - Be sure to disconnect the regulator body and external supply when wiring the measurement input lines. There is a risk of electric shock. - Please connect carefully to the polarity of the input. If you connect it incorrectly, it causes the cause of the main body failure. - Please use SHIELD processed wiring for the input. Also, please ground SHIELD with 1 point. - Route the measurement input signal between the power circuit and the ground circuit if possible. - The FS shall be measured from the minimum to the maximum of each range measurable range. - Digit is the minimum display <p>*1) 0 ~ 400 °C Range: ±10 % of FS ±1 digit *2) Below 0 °C: ±1.0 % of FS ±1 digit *3) 20 → KPt100 Ω (C1603) 21, 22 → Pt100 Ω (IEC751) *4) When using current input, select code number "30" and attach a 250 Ohm 0.1% resistance to the input signal terminal.</p>
	2	K *2	-199.9 ~ 999.9		
	3	J *2	-199.9 ~ 999.9		
	4	E *2	-199.9 ~ 999.9		
	5	T *2	-199.9 ~ 400.0		
	6	R	0 ~ 1700		
	7	B *1	0 ~ 1800		
	8	S	0 ~ 1700		
	9	L *2	-199.9 ~ 900.0		
	10	N	-200 ~ 1300	±1.0 % of FS ±1 digit	
	11	U *2	-199.9 ~ 400.0	±0.5 % of FS ±1 digit	
	12	W	0 ~ 2300		
	13	Platinel II	0 ~ 1390		
Temperature resistance (RTD)	20	KSPt100 Ω *3	-199.9 ~ 500.0	±0.5 % of FS ±1 digit	
	21	Pt100 Ω *3	-199.9 ~ 640.0		
	22	Pt100 Ω *3	-200 ~ 640		
DC Voltage (V d.c. / mV d.c.)	30	1-5 V d.c.	-1999 ~ 9999 (Using scaling functions (SL-H/SL-L))	±0.5 % of FS ±1 digit	
	31	0-10 V d.c.			
	32	-10-20 mV d.c.			
	33	0-100 mV d.c.			
DC Current	30	4-20 mA d.c. *4			

TEMPERATURE CONTROLLER

DX series

Specifications

Model		DX9	DX2	DX7	DX3	DX4
Appearance						
W×H×D (mm)		96.0×96.0×100.0	48.0×96.0×100.0	72.0×72.0×100.0	96.0×48.0×100.0	48.0×48.0×100.0
Input	Thermocouple input	K, J, R				
	RTD input	Pt 100 Ω				
	DC voltage input	1-5 V d.c., 0-10 V d.c., 4-20 mA d.c.				
	Input sampling cycle	250 ms				
	Input display resolution	Basically 1 °C max. (0.1 °C max. on decimal point range)				
	Input impedance	Thermocouple and DC voltage input (mV) : min. 1 MΩ. DC voltage input (V) : approx. 1 MΩ				
	Allowable signal source resistance	Thermocouple max. 250 Ω, DC voltage max. 2 kΩ				
	Lead wire allowable resistance	RTD max. 10 Ω. (but the resistance among 3 lines should be same)				
	Allowable input voltage	±20 V d.c. for 1 min				
	Input correction	±100 % of FS				
	Input scaling	-1999 ~ 9999 (Within SL12 ~ SL13 range, with voltage/current input)				
	Reference contact compensation error	±3.5 °C (0 ~ 50 °C range)				
Input disconnection detection	UP Scale					
Performance	Display accuracy	±0.5 % of FS but ± 1% of FS with voltage input				
	Retransm. output accuracy	±0.2mA d.c. (Load resistance max. 600 Ω, output range 3.2 ~ 20.8 mA d.c.)				
	Insulation voltage	Min. 20 MΩ (500 V d.c.) between input terminal and power terminal, between power terminal and protective earth terminal (enclosure)				
	Dielectric strength	2300 V a.c. 50/60 Hz for 1 min (between input terminal and power terminal, between power terminal and protective earth terminal)				
Control functions and output	Control type	PID Auto-tuning				
	Control operation	Reverse action (heating) or direct action (cooling), by internal setting (SL9)				
	Setting range	Same as input range chart				
	Proportional band	0 ~ 100 % of FS				
	Integral time	0 ~ 3,600 sec				
	Derivative time	0 ~ 3,600 sec				
	ARW(Anti Reset Wind-up)	Auto(A=0), 0 ~ 100 % of FS				
	ON/OFF control	Setting Proportional band to "0" turns ON/OFF control				
	During ON/OFF control hysteresis	0~10 % of FS				
	Control loop break alarm (LBA)	1 ~ 7,200 sec (Generally, 2 times the integral time)				
	Proportional period	1 ~ 100 sec.				
	Decimal point position	1 ~ 4 ("2" When setting 000.0)				
	Retransmission output	4-20 mA d.c. (Measured value)				
	Alarm type	High alarm(ALH), low alarm(ALL), high/low within range alarm (deviation setting, absolute setting)				
	Alarm setting range	0 ~ 100 % of FS				
High alarm (ALH) hysteresis set	0 ~ 10 % of FS					
Output	Relay output	Contact capacity : 1c, 250 V a.c. 5 A (resistive load)				
	Voltage output (SSR)	Approx. min. 12 V d.c. (load resistance min. 600 Ω)				
	Current	4 ~ 20 mA d.c. (load resistance max. 600 Ω). Accuracy: ±0.2 mA				
	Temperature alarm (Relay)	<ul style="list-style-type: none"> ● DX4Alarm output (ALM): high, low alarm, LBA common, 1 a X 1 contact ● High alarm (ALH) : 1 C X 1 contact (but DX7: 1 a X 1 contact) ● Low alarm (ALL) : 1 a X 1 contact 250 V a.c. 5A (resistive load) 				
	LBA (Relay)					
Current output	4 ~ 20 mA d.c. (load resistance max. 600 Ω), accuracy: ±0.2 mA.					
Power voltage	100-240 V a.c. 50/60 Hz, 24 V d.c. (Selection by Suffix code)					
Voltage fluctuation rate	±10 % of power voltage					
Power consumption	12 VA (100-240 V a.c., 24 V a.c.), 4.5 W (24 V d.c.)					
Ambient temperature & humidity	0 ~ 50 °C, 35 ~ 85 % RH (Without condensation)					
Storage temperature	-25 ~ 65 °C					
Vibration resistance	10-55 Hz, 0.76 mm, X, Y, Z each direction 2 hours					
Shock resistance	300 m/s ² 6 directions each 3 times					
Weight (g)	472	342	344	340	342	

Suffix code

Model	Code	Content
DX	□- □ □ □ □ □ □	Digital Temperature Controller
Appearance	2	48(W) x 96(H) mm
	3	96(W) x 48(H) mm
	4	48(W) x 48(H) mm
	7	72(W) x 72(H) mm
	9	96(W) x 96(H) mm
Input	K	K thermocouple
	J	J thermocouple
	R	R thermocouple
	P	RTD (Pt 100 Ω)
	V	1-5 V d.c.
	C	4-20 mA d.c.
	F	0-10 V d.c.
Control output	M	Relay contact output
	C	Current output (4-20 mA d.c.)
	S	SSR (Voltage pulse output, 12 V d.c.)
Alarm output	S	Alarm output 1 contact (Model : DX4)
	W	Alarm output 2 contacts (all models except DX4)
Option	A	Retransmission output (4-20mA d.c. measured value)
	N	None (DX4, DX7 No retransmission output)
Control operation ※ Selection by SL9 (initial value: R)	R	Reverse action (heating control)
	D	Direct action (except cooling)
Power voltage		No display (100-240 V a.c.)
	C	24 V a.c. 50/60 Hz or 24 V d.c.

New product
High function
Programmable Temperature Humidity
Thermal shock Test control
Multi-channel
Economy Ignorance For freezer
Indicator







Range and input code chart

Classification	Code	Input	Range (°C)		Accuracy
			1°C (SL2 : X1XX)	0.1°C (SL2 : X0XX)	
Thermocouple (TC)	0001	K	-50 ~ 1,300	-50.0 ~ 999.9	±0.5 % of FS
	0101	J	-50 ~ 600	-50.0 ~ 600.0	
	0100	R	0 ~ 1700	0.0 ~ 999.9	
RTD	0011	Pt100 Ω	-199 ~ 640	-199.0 ~ 640.0	
Voltage/Current	0000	1-5 V d.c.	-1999 ~ 9999	Decimal point by SL4	1 % of FS
	0000	4-20 mA d.c.	-1999 ~ 9999		
	1111	0-10 V d.c.	-1999 ~ 9999		

TEMPERATURE CONTROLLER

KX series

Specifications

Model		KX9N	KX2N	KX7N	KX3N	KX4N	KX4S
외형							
W×H×D(mm)		96.0×96.0×100.0	48.0×96.0×100.0	72.0×72.0×100.0	96.0×48.0×100.0	48.0×48.0×100.0	48.0×48.0×87.0
Input	Thermocouple input	K, J, E, T, R, B, S, L, N, U, W, PL2					
	RTD input	Pt 100 Ω, KPt 100 Ω					
	DC voltage input	1-5 V d.c. (4-20 mA d.c.), 0-10 V d.c.					
	Input display resolution	Basically, below the range decimal point					
	Input sampling cycle	250 ms					
	Allowable signal source resistance	Max. 250 Ω (Thermocouple input), max. 2 kΩ (DC voltage input)					
	Lead wire allowable resistance	RTD : max. 10 Ω/1 wire. The resistance between 3 lines should be same					
	Allowable input voltage	±20 V d.c. for 1 min					
	Scaling	0.0 % ~ 100.0 % of FS					
	Reference contact compensation error	±3.5 °C (0 ~ 50 °C range)					
Input disconnection function	Up-scale and output OFF when input is disconnected						
Performance	Display accuracy	± 0.5 % of FS (but, 0 ~ 400 °C range of B thermocouple is out of guarantee range). Refer to "range and input code chart"					
	Insulation Resistance	Min. 20 MΩ, 500 V d.c., for 1 min (between 1st and 2nd terminal)					
	Dielectric strength	2300 V a.c. 50/60 Hz for 1 min (between 1st and 2nd terminal)					
Control functions and output	Setting range	Refer to "Range and input code chart"					
	Control type	PID control, ON/OFF control					
	Proportional band (P)	Within input range					
	Integral time	0 ~ 3600 sec.					
	Derivative time	0 ~ 3600 sec.					
	ARW (Anti Reset Wind-up)	Within input range					
	Control loop break alarm (LBA)	0 ~ 7200 sec.					
	Proportional period	0 ~ 100 sec.					
	Control output hysteresis	0 ~ 10 % of FS					
	ON/OFF control	Set the Proportional band to "0" (0.0)					
	Alarm type	Absolute alarm, deviation alarm (high alarm, low alarm, within range alarm)					
	Range over display	When exceed max. range "0000", when exceed min range "UUUU" flashing					
	Decimal point function	Decimal point position selection by parameter during DC voltage input					
	Decimal point position selection	Decimal point selection during current input and DC voltage (0~3 position)					
	Input correction value setting	-100.0 ~ 100.0 of FS					
	High or low alarm hysteresis	0 ~ 10 % of FS					
	High / Low range Limit	Within input range					
Output operation	Direct / reverse action selectable by setting						
Scale setting	-199 ~ 9999 (High and low scale setting during DC voltage input)						
Control output	Relay output	● NO : 5 A 250 V a.c., 5 A 30 V d.c. (Resistive load) ● NC : 3 A 250 V a.c., 1 A 30 V d.c. (Resistive load)					
	Voltage output (SSR)	Min. 12 V d.c., pulse voltage (load resistance min. 600 Ω)					
	Current output (SCR)	4-20 mA d.c. (Load resistance min. 600 Ω), Accuracy : ±0.2 mA					
Alarm output	Relay output	250 V a.c. 3 A (load resistance) ※ refer to connection diagram(contact), but KX4N: 1A contact, 250 V a.c. 1 A (load resistance)					
Retransm. output	Current output	4-20 mA d.c. (Load resistance max. 600 Ω), Accuracy: ±0.2 mA					
Power voltage		100-240 V a.c. 50/60 Hz, 24 V d.c. (KX4S 제외)					
Voltage fluctuation rate		±10 % of power voltage					
Power consumption		11 VA max.				7 VA max.	
Ambient temperature & humidity		0 ~ 50 °C, 35 ~ 85 % RH (Without condensation)					
Weight (packed)		400	320	300	320	180	

Suffix code

Model	Code				Content	
KX	□	□	□	□	Digital Temperature Controller (Multi Input)	
Dimensions	2N				48(W) X 96(H) mm	
	3N				96(W) X 48(H) mm	
	4N				48(W) X 48(H) mm	
	7N				72(W) X 72(H) mm	
	9N				96(W) X 96(H) mm	
	4S				48(W) X 48(H) mm	For 11 pin sockets (2-stage step function by external contact)
Control output	M				Relay	
	S				SSR (Voltage pulse 12 V d.c.)	
	C				SCR (Current 4-20mA d.c.)	
Alarm output	C				※ KX4N, KX4S only	ALH, ALL, LBA (1a common output)
					※ KX4S Not selectable	
	E				KX2N, KX3N, KX9N	ALH(1c),ALL(1a)
					KX7N, KX4N (Optional)	ALH(1a),ALL(1a)
	K				※ KX4N, KX4S Not selectable	
					KX2N, KX3N, KX9N (Optional)	ALH(1c),ALL(1a),LBA(1a)
				KX7N (Optional)	ALH(1a),ALL(1a),LBA(1a)	
Retransmission output (optional)	A				※ Selectable only in the following models KX4N-□C KX2N-□E, KX3N-□E, KX9N-□E KX2N-□K, KX3N-□K, KX9N-□K	Retransmission output (RET) 4-20 mA d.c.
		N			None	
Power voltage	A				100-240 V a.c. 50/60 Hz	
		D			24 V d.c. (But KX4S excluded)	

New product
High function
Programmable Temperature Humidity
Thermal shock Test control
Multi-channel
Economy Ignorance For freezer
Indicator

* When using 4 - 20 mA input, please attach 250 Ω 0.1% resistor to 1 - 5 V d.c input terminal

Range and Input Type

Classification	Code(SL1)	Input type	Range (°C)		
			1 °C (SL2 : X1XX)	0.1 °C (SL2 : X0XX)	
Thermocouple(TC)	0001	K	- 50 ~ 1300	- 50.0 ~ 999.9	
	0101	J	* 2	- 50 ~ 600	- 50.0 ~ 600.0
	1100	E		- 199 ~ 999	- 199.9 ~ 999.9
	1101	T		- 50 ~ 400	- 50 ~ 400.0
	0100	R		0 ~ 1700	0.0 ~ 999.9
	0110	B	* 1	0 ~ 1800	0.0 ~ 999.9
	0111	S		0 ~ 1700	0.0 ~ 999.9
	1000	L	* 2	- 199 ~ 900	- 199.9 ~ 900.0
	1001	N	* 2	- 199 ~ 1300	- 199.9 ~ 999.9
	1010	U		- 199 ~ 400	- 199.9 ~ 400.0
	1011	W(Re5-Re25)		0 ~ 2300	0.0 ~ 999.9
RTD	0010	KPt100 Ω(Old type)		- 199 ~ 500	- 199.9 ~ 500.0
	0011	Pt100 Ω(IEC)		- 199 ~ 640	- 199.9 ~ 640.0
DC Voltage(V d.c.)	0000	1-5 V d.c.	* 3	- 199 ~ 9999	Select Decimal Points by SL4
	1111	0-10 V d.c.	* 3		

※ K, J, E, T, R, B, S, N : IEC 584. L, U : DIN 43710, W(Re5-Re25) : Hoskins Mfg.Co.USA. Pt100 Ω : IEC 751, KS C1603. (Kpt100 Ω : Rt =139.16 Ω

※ Rt : Resistance value at 100°C).

※ 4 - 20 mA When using a current input, attach 250 Ω 0.1% shunt resistance to both ends of the input terminals in 1-5 V d.c. input mode.

※ Degree : ± 0.5 % of FS

* 1) The 0 to 400°C range is outside the warranty range

* 2) ±1% of FS in the range below 0°C

* 3) ± 1 % of FS

TEMPERATURE CONTROLLER

TD510 CE

Specifications

Model		TD510		
Appearance				
W×H×D (mm)		145.0×145.0×33.5		
Power voltage		100-240 V a.c. 50/60 Hz (Voltage fluctuation rate: ±10 % of power voltage) 30 V A max		
Dielectric strength		<ul style="list-style-type: none"> ● Between 1st and 2nd terminals: Min. 1500 V a.c for 1 min ● Between 1st and FG terminals: Min. 1500 V a.c for 1 min ● Between 2nd and FG terminals: Min. 1500 V a.c for 1 min 		
Input type		<ul style="list-style-type: none"> ● 2 types of RTD (Pt-100, KPt-100) ±0.1 % of FS ±1 Digit ● 11 types of thermocouple (K, J, E, T, R, B, S, L, N, U, Wire 5 - 26) ±0.15 % of FS ±1 Digit ● 4 types of DC voltage (-10 - 20 mV, 0 - 100 mV, 1 - 5 V, 0 - 30 V) ±0.1 % of FS ±1 Digit 		
Sampling cycle		250 ms		
Contact output (DO)	Up to 32 relay contacts	A contact	30 V d.c. 3 A max, 250 V a.c. 3 A	
		B contact	NO : 30 V d.c. 5 A max, 250 V a.c. 5 A	
Control output	SSR output	ON : 18 V d.c. Pulse voltage (Load resistance min. 800 Ω)		
	SCR output	4-20 mA d.c. (Load resistance max. 600 Ω)		
Retransmission output	Current output	4-20 mA d.c.		
	Load resistance	Load resistance max. 600 Ω		
	Output type	Present value (PV), Set value (SV), output volume (MV), Random selection		
	Refresh interval	250 ms		
Functions	Input type	Input calibration (sensor bias)	Temperature 2 contacts : EUS(0 ~ 100 %)	
		Scaling	DC voltage (VDC): Input scaling according to conversion range	
		Input filter(LPF)	0 ~ 120 sec	
	Control mode	Operation type	Constant-value / Program control	
	Control output	Temperature control output	SSR or SCR (4 - 20 mA d.c.) output selection	
		Pattern	100 patterns (1 pattern / 100 segments)	
	Control operation	Segment	2,000 segments	
		PID group	4 groups	
		Auto-tuning	Auto-tuning according to target set value	
		Proportional band	0.00 ~ 100.00 % (ON / OFF control for 0.00%)	
		Integral time	0 ~ 3,000 seconds (OFF state if 0 second is set)	
		Derivative time		
		ON/OFF control	Set proportional band (PB) to 0	
		Direct/reverse action	Depending on the direct/reverse action selection of the control output	
	Hysteresis	EUS (0 ~ 100 %)		
Retransmission output	Temperature (Ch.1 and 2)	4 - 20 mA d.c. Present value (PV), Set value (SV), output volume (MV)		
	Scaling	Auto scaling for defined upper/lower, limit range (4 - 20 mA d.c.)		
Alarm setting	Setting alarm	System alarm: 8 contacts. Assign 4 of 8 pattern alarms to a pattern		
	Alarm type	High/Low absolute, High/Low deviation, Within/Out of range (alarm direction, hold)		
	Absolute alarm setting range	EU (0 ~ 100 %)		
	Deviation alarm setting range	EUS (-100 ~ 100 %)		
	Hysteresis	EUS (0 ~ 100 %)		
Display		TFT Color LCD (115.2 × 86.4 mm)		
Resolution		640 × 480 pixel		
Back light		LED Back light		
Back light life		Approx. 40,000 h		
Touch type		Resistive type (4 Wires)		
Language		Korean/English/Chinese (Simplified)		
Saving functions	Internal memory	Non-volatile memory : 80 MB		
	External memory	SD Card (8 GB)		
	Saving interval	1 ~ 360 sec		
Memory information		Program information, set value save, recovery, temperature set / process / output value		
Ambient temperature & humidity		0 ~ 50 °C, 20 ~ 90 % RH (Without condensation)		
Weight (g)		1,320		

Suffix code

Model	Code	Content
TD51	<input type="checkbox"/> - <input type="checkbox"/> <input type="checkbox"/> <input type="checkbox"/> <input type="checkbox"/>	Programmable Temperature Controller
Channels	0	2 Channel
	1	1 Channel
Display part	1	5.7" TFT-LCD
	N	None
Input/output	1	8 input contacts · 6 output contacts (1 module)
	2	8 input contacts · 14 output contacts (2 modules)
	3	16 input contacts · 16 output contacts (3 modules)
	N	No input/output
Language	S	Korean, English and Chinese (simplified)
	T	Korean, English and Chinese (traditional)

Components

Product	Model	Content
Display part	TD51□-1N□	Display part (5.7" TFT LCD)
Control module	TD510-MAIN	Temperature 2-channel control module
	TD511-MAIN	Temperature 1-channel control module
Power module	TM-PWR	Power module
Input module	TM-DI	Module with 16 input contacts
Output module	TM-DO	Module with 8 output contacts
Input/output module	TM-DIO	Module with 8 input and 6 output contacts

※ This product consists of display part / power module / control module / input module / output module (digital input (DI) with up to 32 contacts, digital output (DO) with up to 32 contacts).

New product
High function
Programmable Temperature Humidity
Thermal shock Test control
Multi-channel
Economy Ignorance For freezer
Indicator

TD300

Specifications

Model	TD300	
Appearance		
W×H×D (mm)	96.0×96.0×100.0	
Power voltage	100-240Va.c. 50/60 Hz Max. 10 W (voltage fluctuation rate: ±10 % of power voltage)	
Screen	3.5" TFT-LCD and touch panel interface	
Program	Up to 100 patterns, individual pattern operation possible for each channel / Up to 2,400 segments (up to 100 segments per pattern)	
Input (2 channels)	Pt100 (IEC751)	-200.0 ~ 640.0 °C, ±0.1 % of FS
	TC_K	-200.0 ~ 1,370.0 °C, ±0.1 % of FS
	TC_J	-200.0 ~ 1,200.0 °C, ±0.1 % of FS
	TC_E	-200.0 ~ 1,000.0 °C, ±0.1 % of FS
	TC_T	-200.0 ~ 400.0 °C, ±0.1 % of FS
	TC_R	0 ~ 1,700.0 °C, ±0.1 % of FS
	TC_S	0 ~ 1,700.0 °C, ±0.1 % of FS
	mV	0 - 100 mV or -10 - 20 mV (-999.9 ~ 9999.9), ±0.1 % of FS
	VDC	0 - 10 V (The signal range can be set, -999.9 ~ 9999.9), ±0.1 % of FS
4 - 20 mA	4 - 20 mA : 250 Ω using the external resistor, V d.c. 1 ~ 5 V using after setting	
Sampling cycle	500 ms	
Output	Control output	2 contacts for each channel (heating/cooling)
	Voltage pulse output (SSR)	24 V d.c. Pulse (Load resistance min. 600 Ω), minimum pulse width : 10 ms
	Current output (SCR)	4-20 mA d.c. (Load resistance max. 600 Ω)
	Relay output	NO → 250 V a.c. 5 A / 30 V d.c. 5 A
Communication	Protocol	PCLINK, Modbus-ASCII
	Specifications	● RS232C : 9600 ~ 38400 bps max. 10 m ● RS422/485 : 9600 ~ 38400 bps max. 1.2 km 256 Mode
Ambient temperature & humidity	0 ~ 50 °C, 20 ~ 90 % RH (Without condensation)	
Weight(g)	850	

Suffix code

Model	Code	Content
TD300	<input type="checkbox"/> <input type="checkbox"/>	2-Channel Programmable Temperature Controller
Communication	1	RS485/422
	2	RS232C
Language	1	Korean/English (standard type)
	2	English/Chinese (simplified)

TEMPERATURE CONTROLLER

TH510 CE

Specifications

Model		TH510	
Appearance			
W×H×D (mm)		145.0×145.0×33.5	
Power voltage		100-240 V a.c. Voltage fluctuation rate ±10 %	
Power frequency		50/60 Hz	
Power consumption		30 V A max	
Dielectric strength		<ul style="list-style-type: none"> ● Between 1st and 2nd terminals: Min. 1500 V a.c. for 1 min ● Between 1st and FG terminals: Min. 1500 V a.c. for 1 min ● Between 2nd and FG terminals: Min. 1500 V a.c. for 1 min 	
Input type		<ul style="list-style-type: none"> ● 2 types of RTD (Pt-100, KPt-100) ±0.1 % of FS ±1 Digit ● 2 types of DC voltage (1 - 5 V, 0 - 30 V) ±0.1 % of FS ±1 Digit 	
Sampling cycle		250 ms	
Contact outputs(DO)	Relay contact max. 32 contacts	A contact	30 V d.c. 3 A max, 250 V a.c. 3 A
		B contact	NO : 30 V d.c. 5 A max, 250 V a.c. 5 A
Control output	SSR output	ON : 18 V d.c. pulse voltage (load resistance min. 800 Ω)	
	SCR output	4-20 mA d.c. (Load resistance max. 600 Ω)	
Retransmission output	Current output	4-20 mA d.c.	
	Load resistance	Load resistance max. 600 Ω	
	Output type	Present value (PV), Set value (SV), output volume (MV), Random selection	
	Refresh interval	250 ms	
Input type	Input calibration (sensor bias)	Temperature 1 contact: EUS (0 ~ 100%) Humidity 1 contact: EUS (0 ~ 100%)	
	Dry/wet bulb sensor compensation	Compensate the difference between the wet and dry bulb sensor after removing the wet bulb sensor gauze.	
	Scaling	DC voltage (VDC): Input scaling according to conversion range	
	Input filter (LPF)	0 ~ 120 sec	
Control mode	Operation type	Constant-value / Program control	
Control output	Temperature control output	Output (SSR) or current output (4 - 20 mA d.c.) selection	
	Humidity control output		
Control operation	Pattern	100 patterns (1 pattern / 100 segments)	
	Segment	2000 Segment	
	PID group	16 groups (temperature 4 zones X humidity 4 zones)	
	Auto-tuning	Auto-tuning according to target set value	
	Proportional band	0.00 ~ 100.00 % (for 0.00 %, ON/OFF control)	
	Integral time	0.0 ~ 3000 sec. (OFF status when 0 sec is set)	
	Derivative time		
ON/OFF control	Set 0.0 to proportional band (PB)		
Re-transmission output	Temperature, Humidity	Current output (4 - 20 mA d.c.) Present value PV, Set value (SV), output volume (MV) selection	
	Scaling	Automatic scaling of set high and low range (4 - 20 mA d.c.)	
Alarm setting	Setting alarm	System alarm: 8 contacts Assign 4 of 8 pattern alarms to a pattern	
	Alarm type	High/Low absolute, High/Low deviation, Within/Out of range (alarm direction,hold)	
	Absolute alarm setting range	EU (0 ~ 100 %)	
Display		TFT color LCD (115.2 × 86.4 mm)	
Resolution		640 × 480 pixel	
Back light		LED back light	
Back light life		Approx. 40,000 h	
Touch type		Resistive type (4 Wires)	
Language		Korean/English/Chinese (simplified)	
Saving functions	Internal memory	Non-volatile memory : 80 MB	
	External memory	SD card (8 GB)	
	Saving interval	1 ~ 360 sec	
Memory information		Program information, set value, recovery, temperature set / process / output value	
Ambient temperature & humidity		0 ~ 50 °C, 20 ~ 90 % RH (without condensation)	
Weight (g)		1,320	

Suffix code

Model	Code	Content
TH	<input type="checkbox"/> 1 <input type="checkbox"/> 0 - <input type="checkbox"/> <input type="checkbox"/> <input type="checkbox"/>	Programmable Temperature & Humidity Controller
Display part	5	5.7" TFT-LCD
Input/output	1	8 input contacts.6 output contacts (1 module)
	2	8 input contacts.14 output contacts (2 module)
	3	16 input contacts.16 output contacts (3 modules)
Language	S	Korean, English and Chinese (simplified)
	T	Korean, English and Chinese (traditional)
Communication		RS485
	E	RS485, Ethernet

※ Basic components (power module, Control module)

※ This product consists of power module/control module/Input module/output module 32 contacts, (digital input (DI) with up to 32 contacts, digital output (DO) with up to 32 contacts).

Components

Product	Model	Content
Display part	TH510-1N□	Display part (5.7" TFT LCD)
Control module	TH510-MAIN	Temperature & Humidity Control Module
Power module	TM-PWR	Power module
Input module	TM-DI	Module with 16 input contacts
Output module	TM-DO	Module with 8 output contacts
Input/output module	TM-DIO	Module with 8 input and 6 output contacts

TH300 CE

Specifications

Model	TH300	
Appearance		
W×H×D (mm)	96.0×96.0×100.0	
Program	100 Pattern (100 segments / 1 pattern) max. 2000 segments	
Screen	TFT LCD 70.08 × 52.56 mm (3.5")	
Functions	Contact input (DI): 4 contacts, Contact output (DO): max. 12 contacts, RS232/485	
Power voltage	100-240 V a.c. 50/60 Hz (voltage fluctuation rate: ±10 %)	
Display accuracy	● Temperature (°C) : ±0.2 % of FS ● Humidity (%RH) : ±2 % of FS	
Sampling cycle	500 ms	
Input type	Pt100 Ω or 0-5 V d.c.	
Output	Control output (OUT)	● ON : 24 V d.c. pulse voltage ● OFF : 0.1 V d.c. max. ● Pulse voltage (load resistance min. 800 Ω) ● Cycle time: 1 ~ 1000 sec
	Retransmission output (RET)	● Temperature / humidity : 4 - 20 mA d.c. (load resistance max. 600 Ω) present value (PV), output volume (MV), set value (SV) ※by internal selection ● Resolution: approx. 7,000 ● Refresh interval : 500 ms
	Contact output (DO)	● Relay : 8 contacts (1a X 8 contacts), N.O : 30 V d.c. 5 A, 240 V a.c. 5 A ● Transistor: 4 contacts (open collector output). 24 V d.c. 300 mA max
Control type	PID auto-tuning	
Ambient temperature & humidity	0 ~ 50 °C, 20 ~ 90 % RH (Without condensation)	
Weight (g)	850	

Suffix code

Model	Code	Content
TH300	<input type="checkbox"/> <input type="checkbox"/>	Programmable Temperature & Humidity Controllers
Communication	1	RS232C communication
	2	RS485/422 communication
Language	1	Korean/English (standard type)
	2	English/Chinese (simplified)
	3	English/Chinese (traditional)

New product

High function

Programmable Temperature Humidity

Thermal shock Test control

Multi-channel

Economy Ignorance For freezer

Indicator

TEMPERATURE CONTROLLER

NP200

Specifications

Model		NP200
Appearance		
W×H×D(mm)		96.0×96.0×100.0
Power voltage		100-240 V a.c. 50/60 Hz voltage fluctuation rate: ±10 %
Power consumption		Max. 6.0 W / max. 10 VA
Input (Multi Input)	Thermocouple input	K, J, E, T, R, B, S, L, N, U, W, PLII,
	RTD	Pt100 (KS/IEC 751), KPt100 (KS)
	DC voltage input	1-5 V d.c. 0 - 10 V, -10 - 20 mV, 0 - 100 mV
	DC Current input	4 - 20 mA (Attach 250 Ω external resistor)
Control		● Relay output, voltage output (SSR), current output (SCR) ● Control behavior : PID control, ON/OFF control
Alarm type		High/Low, High/Low deviation
Communication method		RS485/422, 2-wire half-duplex or 4-wire half-duplex (by wiring method)
Setting		By front Shift up, Down keys
Display		PV : Digital LED, SV : Graphic LCD
Display accuracy		0.1 % of FS (Full Scale)
Setting accuracy		1 or 0.1 % (according to input range)
External control		4 alarm outputs (Run, Reset, Step, Hold)
Pattern		30 patterns, Up to 99 segments per pattern can be set
Segment		300 Segment
Set time unit of program		Hours, minutes or minutes, seconds
Sampling cycle		100 ms
Insulation Resistance		Min. 500 V a.c. 20 MΩ
Dielectric strength		2300 V a.c. 50/60 Hz for 1 min (between 1st and 2nd terminals and between 1st terminal and ground)
Ambient temperature & humidity		0 ~ 50 °C, 35 ~ 85 % RH (Without condensation)
Weight (g)		696

Suffix code

Model	Code	Content
NP200	<input type="checkbox"/> <input type="checkbox"/>	Programmable Temperature Controller (96 X 96 mm)
Control type	0	Normal type (heating)
	1	Heating/cooling type (synchronous control type)
Option	0	None
	1	RS422 / 485 (Communication function)
	2	DI 4 contacts (DI 4~7)
	3	RS422 / 485(Communication function), DI 4contacts

※ Selection specification of DI 1 to 3 standard mounting (DI 4 to 7)

Range and Input Type

Classification	Input	Input code	Range(°C)	Accuracy	Relative height
Thermocouple(TC)	K	*1 K1	-200.0 ~ 1370.0	±0.10 % of FS ±1digit	※ Display Range: -5% of the above range ~ +105 % *1: Below 0°C : ±0.2 % of FS ±1digit *2 : 0 ~ 400 °C Range : ±5 % of FS ±2digit
	K	*1 K2	-200.0 ~ 1000.0		
	J	*1 J	-200.0 ~ 1200.0		
	E	*1 E	-200.0 ~ 1000.0		
	T	*1 T	-200.0 ~ 400.0		
	R	R	0 ~ 1700	±0.15 % of FS ±1digit	
	B	*2 B	0 ~ 1800		
	S	S	0 ~ 1700	±0.1 % of FS ±1digit ±0.2 % of FS ±1digit	
	L	*1 L	-200.0 ~ 900.0		
	N	N	-200.0 ~ 1300.0		
	U	*1 U	-200.0 ~ 400.0		
W	W	0 ~ 2300			
RTD	Platinel II	Platinel2	0.0 ~ 1300.0	±0.1 % of FS ±1digit	
	JPt100	JPT100	-200.0 ~ 500.0		
DC Voltage(V)	Pt100	PT100	-200.0 ~ 640.0	Scaling range SL-L ~ SL-H = -2000 ~ 14000	
	1 - 5 V	1/5 V	※ If current input is used, attach a 250 Ω 0.1% resistance between terminals 19 and 20 to use it as a 4-20 mA d.c. input.		
0 - 10 V	0/10 V				
DC Voltage(mV)	-10 - 20 mV	10/20 mV			
DC Current	0 - 100 mV	0/100 mV			
	4-20 mA d.c.	1/5 V※			

TS510 CE

Specifications

Model		TS510	
Appearance			
W×H×D (mm)		145.0×145.0×33.5	
Power voltage		100 – 240 V a.c. Voltage fluctuation rate: ±10 % of power voltage ±10 %	
Power frequency		50/60 Hz	
Power consumption		30 VA max	
Dielectric strength		<ul style="list-style-type: none"> ● Between 1st and 2nd terminals: min. 1500 V a.c. for 1 min ● Between 1st terminal and FG: min. 1500 V a.c. for 1 min ● Between 2nd terminal and FG: min. 1500 V a.c. for 1 min 	
Input type		<ul style="list-style-type: none"> ● Thermocouple 11 types (K, J, E, T, R, B, S, L, N, U, Wre 5-26) ±0.15 % of FS ±1 digit ● RTD 2 types (Pt-100, KPt-100) ±0.1 % of FS ±1 Digit, ● Current voltage 4 types (-10 ~ 20 mV, 0 ~ 100 mV, 1 ~ 5 V, 0 ~ 30 V) ±0.1 % of FS ±1 Digit 	
Sampling cycle		250 ms	
Contact outputs (DO)	Relay contact max. 32 contacts	A contact	30 V d.c. 3 A max, 250 V a.c. 3 A
		B contact	NO : 30 V d.c. 5 A max, 250 V a.c. 5 A
Control output	SSR output	ON : 18 V d.c. Pulse voltage (Load resistance min. 800 Ω)	
	SCR output	4~20 mA d.c. (Load resistance max. 600 Ω)	
Retransmission output	SCR output	4~20 mA d.c.	
	Current output	Load resistance max. 600 Ω	
	Load resistance	Laboratory PV, Laboratory SV, hot chamber PV, cold chamber PV	
	Output type	250 ms	
Input	Input correction	EUS(0 ~ 100 %)	
	Input filter	0 ~ 120 sec	
Control operation	Control output	Output (SSR) or current output (4 ~ 20 mA d.c.) selection	
	Test pattern	Max. 100, test type (10 types) selection per each pattern	
	PID group	Hot chamber/cold chamber each 4 groups, deviation PID	
	Auto-tuning	Auto-tuning according to target set value	
	Proportional band	0.00 ~ 100.00 % (for 0.00 %, ON/OFF control)	
	Integral time/ Derivative time	0.0 ~ 3000 sec. (OFF status when 0 sec is set)	
	ON/OFF control	Set 0.0 to proportional band (PB)	
	Direct/reverse action	Depending on the direct/reverse action selection of the control output	
	Direct/reverse action	ARW zone setting (50 ~ 1000 % of proportional band)	
	A.T GAIN	0.0 ~ 10.0	
Alarm setting	Setting alarm	System alarm 8 contacts	
	Alarm type	High/Low absolute, High/Low deviation, Within/Out of range (alarm direction, hold)	
	Absolute alarm setrange	EU (0 ~ 100 %)	
Display		TFT color LCD (115.2 × 86.4 mm)	
Resolution		640 × 480 pixel	
Back light		LED back light	
Back light life		Approx. 40,000 h	
Touch type		Resistive type (4 Wires)	
Language		Korean/English/Chinese (simplified)	
Saving functions	Internal memory	Non-volatile memory : 80 MB	
	External memory	SD card (8 GB)	
	Saving interval	1 ~ 360 sec	
Memory information		Program information, set value, recovery, temperature set / process / output value	
Ambient temperature & humidity		0 ~ 50 °C, 20 ~ 90 % RH (Without condensation)	
Weight(g)		Approx. 1.32 kg	

New product
High function
Programmable Temperature Humidity
Thermal shock Test control
Multi-channel
Economy Ignorance For freezer
Indicator

Suffix code

Model	Code	Content
TS510-	<input type="checkbox"/> <input type="checkbox"/> <input type="checkbox"/>	Thermal Shock Test Controller
Display part	1	5.7" TFT-LCD
	N	None
Input/output	1	16 input contacts · output 8 contacts (2 modules) + power module + control module
	2	16 input contacts · 16 output contacts (3 modules) + power module + control module
	3	16 input contacts · output 24 contacts (4 modules) + power module + control module
	N	No input/output
Language	S	Korean, English and Chinese (simplified)
	T	Korean, English and Chinese (traditional)

Components

Product	Model	Content
Display part	TS510-1N□	Display part (5.7" TFT LCD)
Control module	TS510-MAIN	Temperature 3-channel control module
Power module	TM-PWR	Power module
Input module	TM-DI	Module with 16 input contacts
Output module	TM-DO	Module with 8 output contacts
Input/output module	TM-DIO	Module with 8 input and 6 output contacts

※ This product basically consists of display and control parts (power, control, input, output modules). Digital input (DI) with up to 32 contacts, digital output (DO) with up to 32 contacts

TEMPERATURE CONTROLLER

ML

Specifications

Model	ML-D4	ML-D2H	ML-E
Appearance			
W×H×D(mm)	30.0×100.0×96.9		
Power voltage	24 V d.c.		
Voltage fluctuation rate	±10 % of power voltage		
Power consumption	ML-D4S/C Max.7W	ML-D4M Max.5W	ML-D2H MM Max.5W
Thermocouple	K, J, E, T, R, B, S, L, N, U, W, PL2		
RTD	Pt 100 Ω, KPt 100 Ω		
DC voltage	0 - 100 mV, 1 - 5 V, 0 - 10 V		
Sampling cycle	50 ms		
Input display resolution	Below minimum unit of input range		
Input impedance	Thermocouple and DC voltage input: min. 1 MΩ		
Allowable input	<ul style="list-style-type: none"> ● Allowable input voltage : Within -2 - 5 V (thermocouple, RTD), within -5 to 12 V (DC voltage) ● Effect of allowable input resistance : approximately 0.2 uV/Ω ● Permissible input line resistance: not more than 10 Ω of side temperature resistance. However, the resistance between the three lines will be the same) 		
Input correction	±100% of input range		
Reference junction compensation error	±1.5 °C (0 ~ 50 °C)		
Input disconnection detection (Burn-out)	up scale		
Control Output	Relay	● 1a contact ● 250 V a.c. 3 A, 30 V d.c. 3 A	
	Voltage output (SSR)	● Approx. 12 V min (Load resistance min. 600 Ω) with short-circuit, limit to about 25 mA ● Time resolution: bigger between control cycle 0.1 % or 10 ms	
	Current output (SCR)	● 4-20 mA d.c. (Load resistance min. 600 Ω) ● Accuracy: ±0.1 % of FS (4 - 20 mA range)	
RS232C communication	<ul style="list-style-type: none"> ● Communication method : RS-232 standard ● Max. communication distance : 15 m ● Communication speed : 9600 bps ● Start bit : 1 bit ● Data length : 8 bit ● Parity bit : Even ● Stop bit : 1 bit ● Supported protocol : PC-Link 		
RS485 communication	<ul style="list-style-type: none"> ● Max. number of connections : 31 units ● Communication sequence : No sequence ● Response time : Reception handling time + (response time x 10 ms) ● Stop bit : 1, 2 bit [initial value: 1] ● Data length : 7, 8 bit [initial value: 8] ● Parity bit : None, odd, even [initial value: even] ● Start bit : 1 bit ● Max. communication distance : 1200 m ● Communication method : RS485 standard / 2-wire half-duplex ● Supported protocol : PC-Link, PC-Link with SUM, Modbus ASCII/RTU [[Initial value: PC-Link] ● Communication speed : 9600, 19200, 38400, 57600, 76800 bps [Initial value: 9600] 		
Ambient temperature & humidity	0 ~ 50 °C / 35 ~ 85 % RH (Without condensation)		
Operating environment	No toxic gases, magnetic fields or dust generating areas		
Warming-up	At least 30 min		
Ambient temperature influence	Thermocouple, DC voltage: bigger between ±3 uV / °C or ±0.03 % of FS / °C, RTD : ±0.1 °C / °C max		
Power supply change influence	Bigger between ±3 uV / 10 V or ±0.03 % of FS / 10 V		
Storage temperature & humidity	-25 ~ 65 °C / 5 ~ 95% RH (Without condensation)		
Weight (g)	220		

Suffix code

ML-D2H Modular Temperature Controllers

Model	Code	Content
ML-D	2 H □	Modular Temperature Controller
Number of channels	2	2 Channels
Input	H	Heating/cooling control (simultaneous), heater break alarm (HBA)
Control output	MM	OUT1 : Relay output / OUT2 : Relay output
	SM	OUT1 : SSR Output / OUT2 : Relay output
	SS	OUT1 : SSR Output / OUT2 : SSR Output
	CM	OUT1 : 4-20 mA d.c. / OUT2 : Relay output
	CS	OUT1 : 4-20 mA d.c. / OUT2 : SSR Output
	CC	OUT1 : 4-20 mA d.c. / OUT2 : 4-20 mA d.c.

ML-D4 Modular Temperature Controllers

Model	Code	Content
ML-D	4 □	Modular Temperature Controller
Number of channels	4	4 Channels
Control output	M	Relay output
	S	SSR output (12 V d.c.)
	C	SCR output (4-20 mA d.c.)

Ex: temperature controller 4 channel relay output : ML-D4M

ML-E Modular Event Outputs

Model	Content
ML-E	Modular Event Output Unit (8 contacts relay)

MT100

Specifications

Model		MT100
Appearance		
W×H×D(mm)		155.0×130.0×16.5
Input	Display screen	MONO LCD (128 X 64 mm)
	Temperature input (Multi Input)	4 contacts, thermocouple (K,J), RTD (Pt 100 Ω)
	Sampling cycle	1 Sec
	Measuring range	0 ~ 300 °C
	Input correction	±100 % of FS
	Input impedance	Approx. 1 MΩ (thermocouple input)
	Reference contact compensation error	± 1.5 °C (0 ~ 50 °C range)
	Allowable input lead resistance	RTD (max. 10 Ω, but the resistance among 3 lines should be same)
	Input disconnection detection	UP SCALE(Reverse action), DOWN SCALE(Direct action)
	Pressure input	contact (4 - 20 mA d.c. or contact input)
	Pressure sampling cycle	1sec.
	Pressure scale range	0.00 ~ 10.00 (Decimal point fixed)
	Control input	Max. 8 contacts (ON / OFF resistance: 1 ~ 10 KΩ)
Performance	Display accuracy	Temperature: ±0.3 % of FS ±1 Digit, pressure: ±3 % of FS ±1 Digit
	Insulation Resistance	Min. 20 MΩ (500 V d.c.) measuring terminal-power terminal
	Dielectric strength	2300 V a.c., 50/60 Hz for 1 min (between measuring terminal and power terminal, between power terminal and ground terminal)
Control functions and output	Digital input (DI)	8 contacts (① Option, ② Over pressure, ③ Overheating, ④ Over pump direct action, ⑤ Over pump reverse action, ⑥ Medium supplement termination, ⑦ Medium supplement start, ⑧ RUN/RESET)
	Current detection input	3 phases (3 CT)
	Contact output (DO)	6 contacts (① Option, ② Temperature alarms, ③ Inhale, ④ Ramp direct action, ⑤ Ramp reverse action, ⑥ Medium supplement)
	Control output	Cooling control output (relay) 1 contact, heating control output (SSR) 1 contact
	Reverse phase detection	3-phase motor reverse rotation detection function
	Operation reservation	Reserve run time (time or weekly reservation)
	Forced cooling	When requiring sudden cooling, 100% cooling output after stopping heating output
	Preheating function	Control by preheating set value to prevent winter frost
	Abnormal history monitoring	Up to 20 errors can be memorized and displayed
	Control type	PID auto-tuning
	Proportional band	0(0.0) to the maximum value of range
	Integral time	1 ~ 3,600 sec
	Derivative time	1 ~ 3,600 sec
	ARW(Anti Reset Wind-up)	Auto, 0 ~ 100 %((Proportional band)
	ON/OFF control	Set the proportional band to "0"
	Alarm type	6 external alarms by contact input
	Communication function	RS485/422
Control output	Cooling (relay)	● Contact capacity: 1 a, 250 V a.c., 1 A, 30 V d.c. 1 A (resistive load) ● Proportional period: 1 ~ 1000 sec ● Time resolution: bigger between 0.1 % or 16.667 ms
	Heating (SSR)	● Voltage pulse: approx. min. 12 V d.c. (load resistance min. 600 Ω) ● Proportional period: 1 ~ 1000 sec, ● Time resolution: bigger between 0.1 % or 16.667 ms
	Contact output 6 contacts (DO)	1 a, 250 V a.c., 1 A, 30 V d.c. 1 A (Resistive load)
Communication specifications	● Communication method : 2-wire half-duplex or 4-wire half-duplex ● Max. number of connections : 31 ● Communication distance : 1,200 m ● Communication sequence : No sequence ● Communication speed: 9,600 bps ● Start bit : 1 bit ● Stop bit : 1 bit ● Data length : 8 bit ● Parity bit : NONE ● Protocol : PC-Link with SUM	
Power voltage	100-240 V a.c. 50/60 Hz	
Voltage fluctuation rate	±10 % of power voltage	
Power consumption	8 VA	
Ambient temperature & humidity	0 ~ 50 °C, 35 ~ 85 % RH (Without condensation)	
Storage temperature	-25 ~ 65 °C	
Weight (g)	850	

New product
High function
Programmable Temperature Humidity
Thermal shock Test control
Multi-channel
Economy Ignorance For freezer
Indicator

Suffix code

Model	Code	Content
MT100	<input type="checkbox"/> <input type="checkbox"/> <input type="checkbox"/>	Multi Input Mold Temperature Controller
Communication	0	No communication
	1	RS485/422
Pressure inspection	0	No pressure inspection
	1	Pressure inspection by contact input
	2	Pressure inspection by 4 - 20 mA d.c.
Current inspection (HB)	0	HB None
	1	HB 3 contacts ※CT(CTL-6-S) sold separately

TEMPERATURE CONTROLLER

MC9 CE

Specifications

Model		MC9	
Appearance			
W×H×D(mm)		96.0×96.0×100.0	
Input	Thermocouple	K, J, R, S, B, E, N, T, W, PL2, U, L	
	RTD	Pt100 Ω, KPt100 Ω	
	DC voltage	0-5 V, 1-5 V, 0-10 V, 4-20 mA (Attach 250 Ω external resistor)	
	Sampling cycle	1 sec	
	Input display resolution	Basically, below the range decimal point	
	Input impedance	Thermocouple and DC voltage input: min. 1 MΩ	
	Allowable input resistance	Approx. 0.2 μV/Ω	
	Allowable input lead resistance	RTD (Max. 10 Ω. but the resistance among 3 lines should be same)	
	Allowable input voltage	Within -2 - 5 V (thermocouple, RTD), within -5 to 12 V (DC voltage)	
	Scaling	0.0 % ~ 100.0 % of FS	
	Input correction	±100 % of FS	
	Reference contact compensation error	±1.5 °C (0 ~ 50 °C range)	
Input disconnection detection		UP SCALE(Reverse action), DOWN SCALE(Direct action)	
Performance	Degree of indication	Thermocouple	Bigger between ±0.3 % of FS ±1 Digit or ±2 °C
		RTD	Bigger between ±0.3 % of FS ±1 Digit or ±0.8 °C
		DC voltage	±0.3 % of FS ±1 Digit
	Insulation Resistance	20 MΩ 이상 (500 V d.c.), measuring terminal - power terminal	
	Dielectric strength	2,300 V a.c. 50/60 Hz, 1 min measuring terminal - power terminal	
Control function and output	Control type	PID auto-tuning	
	Simultaneous channel setting	4/8 channels simultaneous setting of the same value	
	Control operation	a) Reverse action (heating) / direct action (cooling). by "suffix code" b) Heating/cooling simultaneous control (4 channels only)	
	Setting range	Same as range and input code	
	Digital input (DI)	RUN/STOP or control zone selection by contact input	
	Auto-tuning	Auto-tuning by parameter selection	
	Proportional band	0(0.0) to the maximum value of range	
	Integral time	1 ~ 3,600 sec	
	Derivative time	1 ~ 3,600 sec	
	ARW(Anti Reset Wind-up)	Auto, 0 ~ 100 % (Proportional band)	
	Gradient setting	0(0.0) to max. range/1 min (gradient setting for target value)	
	Scan function	Displays the measured value and set value for each channel sequentially	
	ON/OFF control	Set the proportional band to "0"	
	Multi-memory zone	8 zone selection for each channel	
	Heater break alarm (HBA)	0.0 - 100.0 A (ON/OFF control, can be used on time proportional control output)	
	HBA dead band setting	0 ~ 100 sec	
	Loop break alarm (LBA)	0.1 ~ 200.0 min (dead band : 0 ~ 100 sec.)	
	Alarm output	Up to 3 contacts, parallel (OR) operation for all channels (by selected specifications)	
	Alarm type	Selection by parameter	
	Control output	Relay output	● Contact capacity : 1 a, 250 V a.c. 3 A (resistive load) ● Proportional period : 1 ~ 1000 sec ● Time resolution : Lower between 0.1 % or 10 ms
Voltage output (SSR)		● Voltage pulse : approx. min. 12 V d.c. (load resistance min. 600 Ω) ● Proportional period : 1 ~ 1000 sec ● Time resolution : Lower between 0.1 % or 10 ms	
Current output (SCR)		● Current: 4 - 20 mA d.c., 0 - 20 mA (load resistance max. 600 Ω) ● Accuracy: ±1.0 % of FS (4 - 20 mA range)	
Triac		200 V a.c. 0.5 A (Ambient temperature 40 °C max), Zero Crossing function	
Alarm output (relay)	Temperature alarms (AL1,2,3)	1 a, 250 V a.c., 1 A, 30 V d.c. 1 A (resistive load) / Output points: Max. 3 points (by selected specifications)	
	Heater break alarm (HBA)	1 a 1 contact, 250 V a.c., 1 A, 30 V d.c. 1 A (resistive load) ● Measuring current: 1 - 100 A a.c. (resolution: 0.5 A, ± 5 % of FS ± 1 Digit) ● CT for heater break detection: Model name JS81L (J&D Electronic.Co.Ltd) ● Accuracy: bigger between ± 5 % of FS or ± 2 A	
	Loop break alarm (LBA)	1 a 1 contact, 250 V a.c., 1 A, 30 V d.c. 1 A (resistive load) / Proportional period: 1 ~ 1000 sec	
Power voltage		100-240 V a.c. 50/60 Hz	
Voltage fluctuation rate		±10 % of power voltage	
Power consumption		12 VA	
Ambient temperature & humidity		0 ~ 50 °C, 35 ~ 85 % RH (Without condensation)	
Storage temperature		-25 ~ 65 °C	
Vibration resistance		10 - 55 Hz, single amplitude 0.75 mm, 3 axes each direction, 2 h	
Shock resistance		300 m/s ² , 3 axes each direction, 3 times	
Weight (g)		700	

Temperatrue controllers

Suffix code

MC9 (4 channels)

Model	Code	Content
MC9-4	<input type="checkbox"/> <input type="checkbox"/> <input type="checkbox"/> <input type="checkbox"/> <input type="checkbox"/> <input type="checkbox"/>	4-Channel Digital Temperature Controllers
Control Type	D	For cooling control (Direct action)
	R	For heating control (Reverse action)
	W	Heating cooling simultaneous control
Input type	<input type="checkbox"/>	Refer to "Range and input code chart"
Heating output (output 1 ~ 4)	M	Relay contact output
	S	Output for SSR drive
	T	Output for Triac drive
	4	Current output (4-20 mA d.c.)
	5	Current output (0-20 mA d.c.)
Cooling output (output 5~8) * if control types are D and R then fix to N * if control type is W then select among M,S, t, 4 and 5	N	None (if control output operation is DR)
	M	Relay contact output
	S	Output for SSR drive
	T	Output for Triac drive
	4	Current output (4-20 mA d.c.)
	5	Current output (0-20 mA d.c.)
Option	N	None
	1	AL2, AL3
	2	AL2, AL3 + RS232 + contact input
	3	AL2, AL3 + RS485 / 422 + contact input
	4	AL2, AL3 + heater break
Power voltage	2	100-240 V a.c. 50/60 Hz

MC9 (8 channels)

Model	Code	Content
MC9-8	<input type="checkbox"/> <input type="checkbox"/> <input type="checkbox"/> <input type="checkbox"/> <input type="checkbox"/> <input type="checkbox"/>	8-Channel Digital Temperature Controllers
Control Type	D	For cooling control (Direct action)
	R	For heating control (Reverse action)
Input type	<input type="checkbox"/>	Refer to "Range and input code chart"
Heating output (output 1 ~ 4)	M	Relay contact output
	S	Output for SSR drive
	T	Output for Triac drive
	4	Current output (4-20 mA d.c.)
	5	Current output (0-20 mA d.c.)
Cooling output (output 5~8) * if control types are D and R then fix to N * if control type is W then select among M,S, t, 4 and 5	N	None (when selected, input channels 5 ~ 8 are for indication)
	M	Relay contact output
	S	Output for SSR drive
	T	Output for Triac drive
	4	Current output (4-20 mA d.c.)
	5	Current output (0-20 mA d.c.)
Option	N	None (alarm output AL1, 2, 3 built-in)
	2	RS232 + contact input
	3	RS485 / 422 + contact input
	4	heater break
Power voltage	2	100-240 V a.c. 50/60 Hz

New product
High function
Programmable Temperature Humidity
Thermal shock Test control
Multi-channel
Economy Ignorance For freezer
Indicator

Range and input code chart

Classification	Code	Input type	Range (°C)	Accuracy
Thermocouple (TC)	K0	K	-200 ~ 1370	Bigger between $\pm 0.3\%$ of FS ± 1 Digit or ± 2 °C
	K1	K	-199.9 ~ 999.9	
	J0	J	-200 ~ 1200	
	J1	J	-199.9 ~ 999.9	
	E0	E	-199.9 ~ 999.9	
	E1	E	-199.9 ~ 999.9	
	T0	T	-199.9 ~ 400.0	
	R0	R	0 ~ 1700	
	R1	R	0.0 ~ 999.9	
	B0	B	0 ~ 1800	
	B1	B	0.0 ~ 999.9	
	S0	S	0 ~ 1700	
	S1	S	0.0 ~ 999.9	
	L0	L	-199.9 ~ 900.0	
	N0	N	-200 ~ 1300	
	N1	N	-199.9 ~ 999.9	
	U0	U	-199.9 ~ 400.0	
W0	W	0 ~ 2300		
A0	PL2	0 ~ 1390		
RTD	P0	KPt100 Ω	-199.9 ~ 500.0	Bigger between $\pm 0.3\%$ of FS ± 1 Digit or ± 0.8 °C
	D0	Pt100 Ω	-199.9 ~ 600.0	
DC voltage(mV)	V0	0-5 V d.c.	-199.9 ~ 999.9	$\pm 0.3\%$ of FS ± 1 Digit
	V1	1-5 V d.c.	-199.9 ~ 999.9	
	V2	0-10 V d.c.	-199.9 ~ 999.9	

※ When using current input, please attach 250 Ω 0.1% resistor to input signal terminal

TEMPERATURE CONTROLLER

SM100 CE

Specifications

Model		SM100-□□12	SM100-□□16	SM100-□□20
Appearance				
Number of channels		12 channels	16 channels	20 channels
Measurement input	Input type	● Thermocouple (K), range : -199.9 °C ~ 999.9 °C / RTD (Pt100 Ω)		● Range : -199.9 °C ~ 640.0 °C
	Display accuracy	±0.5 % of max. range (± 0.5 % of FS)		
	RJC compensation accuracy	Within display accuracy		
	Sampling cycle	1 sec.		
	Input correction	-1,200.0 °C ~ 1,200.0 °C		
	Input filter	0.0 ~ 120.0 sec.		
	Burn-out operation	Thermocouple : Upscale RTD : Upscale		
Settings and display	Setting method	Setting by communication program		
	Number of settings	12 contacts	16 contacts	20 contacts
	Memory Storage	Storage by Semiconductor		
	Device address setting	Setting by built-in HEX BCD switch (1 to 15)		
Display LED	Power indication, communication indication, control output indication			
Control output	Output Type	SSR driving voltage pulse output (driving voltage: 12 V d.c., load resistance min. 600 Ω)		
	Control operation	Time proportional PID or ON/OFF control		
	Number of PID groups	1 Group / Channel		
	Proportional cycle (output cycle)	1 sec. ~ 100 sec.		
	Proportional band (P)	0 ~ 1200.0 °C		
	Integral time (I)	1 ~ 3600 sec.		
	Derivative time (D)	1 ~ 3600 sec.		
	ARW (Anti Reset Wind-up)	0.1 ~ 100.0 % ※ "0" setting (Auto)		
	Manual reset	0.0 ~ 100.0 % (During ON/OFF control)		
	Hysteresis	0 ~ 120.0 °C (During ON/OFF control)		
	Control output operation	Cooling control (direct action) / heating control (reverse action) selection		
Contact input	Emergency output	0.0 ~ 100.0 %		
	Number of external contact inputs	1 contact (RUN/STOP by built-in dip switch)		
Communication specifications	Communication standard	RS485/422(4-Wire type)		
	Communication method	Half duplex		
	Max. number of connections	15 ※ Address setting by HEX BCD switch		
	Communication sequence	No sequence		
	Start bit	1 Bit		
	Stop bit	1 Bit		
	Parity bit	Even		
	Data length	8 Bit		
	Transmission speed	19200 bps		
	Communication distance	1.2 km max		
	Communication protocol	PC Link with SUM		
Response time	Reception handling time + (response setting time × 25 ms)			
Power voltage	100 ~ 240 V a.c. 50/60 Hz (±10% of rated power voltage)			
Power consumption	max.25 VA			
Insulation resistance	Min. 20 MΩ. between power terminal and ground (500 V d.c. Mega)			
Dielectric strength	2000 V a.c. for 1 min (between power terminal and ground)			
Ambient temperature & humidity	0 ~ 50 °C, 20 ~ 85 % RH (Without condensation)			
Storage temperature	-20 °C ~ 70 °C			
Vibration resistance	10 - 55 Hz 19.6 m/s ² 3 axes 6 directions 2 h			
Shock resistance	196 m/s ² 3 axes 6 directions each 3 times			
Case material	Cold rolled steel plate (SPC)			
Weight (g)	1270			

Suffix code

Model	Code	Content
SM100-	□ □ □ □	Multi-channel Board Type Temperature Controller (basic specifications: alarm output 3 contacts, built-in run/stop SW 1 contact, RS485/422)
Input type	K	K(CA) thermocouple input (IEC 584-1)
	P	Pt100 Ω RTD input (IEC 751)
Output form	A	Control output (SSR driving voltage pulse output)
	N	No control output (Indication only)
Number of control contacts (Number of channels)	20	20 Channels (standard product)
	16	16 Channels
	12	12 Channels

BX8

Specifications

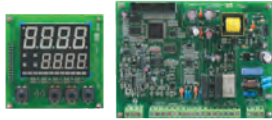
Model		BX8	
Appearance			
Power voltage		100-240 V a.c. (Voltage fluctuation rate: ±10 %)	
Input	Input	<ul style="list-style-type: none"> ● Thermocouple : K, J, E, T, R, B, S, L, N, U, WRe 5-26, PL-II (Refer to input signal and measuring range) ● RTD : Pt100 Ω, KPt100 Ω, ● DC voltage input : 1 - 5 V, -10 - 20 mV, 0 - 100 mV (Freescale) 	
	Sampling cycle	250 ms	
	Input impedance	Thermocouple and DC voltage input (mV): min. 1 MΩ, DC voltage input (V): approx. 1 MΩ	
	Allowable signal source resistance	Thermocouple: max. 250 Ω, voltage: max. 2 kΩ	
	Lead wire allowable resistance	RTD : max. 10 Ω/1 wire (but the conductor resistance among 3 wires should be same)	
	Allowable input voltage	Within ±10 V (thermocouple, RTD, voltage: mV d.c.), within ±20 V (voltage: V d.c.)	
	Noise removal rate	NMRR (normal mode): 40 dB min (50/60 Hz ±1 %), CMRR (common mode): 120 dB min (50/60 Hz ±1 %)	
	Standard	Thermocouple/RTD (KS/IEC 751/DIN)	
	Reference contact compensation error	±1.5 °C (15 ~ 35 °C interval), ±2.0 °C (0 ~ 50 °C interval)	
	Input disconnection detection (BURN-OUT)	Thermocouple: OFF, UP/DOWN Scale selection, RTD : UP Scale (thermocouple and RTD BURN-OUT) detection current: approx. 50 nA	
Measuring accuracy	±0.5 % (FULL SCALE)		
Output	Retransmission output	<ul style="list-style-type: none"> ● Current output range : 4-20 mA d.c. ● Load resistance : max. 600 Ω ● Resolution : approx. 3,000 ● Output refresh interval : 250 ms ● Accuracy : ±0.5% of max. scale (4 - 20 mA range) ● Output ripple : ±0.3% of max. scale (P-P) max. (150 Hz) 	
	Alarm output (HBA)	<ul style="list-style-type: none"> ● Contact capacity : 240 V a.c. 1 A, 30 V d.c. 1 A (Resistive load) ● Contact configuration : 1 a ● Output points: Depending on model specifications (refer to connection diagram) ● Number of contacts : 1 contact · Current measuring range : 1 - 50 A a.c. (resolution: 0.5 A, ±5 % of max. scale ±1 digit) ● Alarm output : selectable in alarm output ● Dead band : 0 ~ 100 % of max. range ● Other : available during ON/OFF control or time proportional output (but not during current output or cooling output) ● Break detection is not possible below 0.2 sec. during output on 	
	Control output	Relay contact output	<ul style="list-style-type: none"> ● Contact capacity : 240 V a.c. 3 A, 30 V d.c. 3 A (Resistive load) ● Contact configuration : 1 C ● Time resolution : smaller between 0.1 % or 10 ms ·Proportional period: 1 ~ 1000 s ● Output operation : Time proportional, ON/OFF ● ON / OFF hysteresis: 0 ~ 100 % (Full Scale) ● Output limit : 0.0 ~ 100.0 % range high limit (OH), low limit(OL) selectable (Also during auto-tuning)
		SSR output (Voltage pulse output)	<ul style="list-style-type: none"> ● ON voltage: min. approx. 24 V d.c. (load resistance min. 600 Ω, 30 mA current limit during short circuit) ● Proportional period : 1 ~ 1000 s ● OFF voltage : max. 0.1 V d.c. ● Output operation: time proportional ● Time resolution : smaller between 0.1 % or 10 ms ● Output limit : 0.0~100.0 % range, high limit (OH) low limit(OL) selectable (also during AT)
		Current output (4 -20 mA)	<ul style="list-style-type: none"> ● Current output range : 4 - 20 mA d.c. ● Load resistance : max. 600 Ω ● Output refresh interval : 250 ms ● Output operation : continuous PID ● Accuracy : ±0.5% of max. scale (4 - 20 mA range) ● Resolution : approx. 3000 ● Output ripple : ±0.3% of max. scale (P-P) max. (150 Hz) ● Output limit : -5.0 ~ 105.0 %range, high limit (OH) low limit(OL) selectable (also during AT)
	Weight (g)	300	

※ Control output : output can be selected from relay, current or SSR, heating / cooling type can be set individually.

Suffix code

Model	Code	Content
BX8-	<input type="checkbox"/> <input type="checkbox"/>	Board Type Digital Temperature Controller
Control type	0	Normal
	1	Heating/cooling type
Option	0	SV2 / SV3 (Basic specifications: alarm output 2 contacts , (1 contact is determined by cooling output))
	1	HBA
	2	RS485
	3	HBA / RS485





New product
High function
Programmable Temperature Humidity
Thermal shock Test control
Multi-channel
Economy Ignorance For freezer
Indicator

TEMPERATURE CONTROLLER

HY-8000/8200/72/48

UPGRADE

Specifications

Model		HY-48	HY-72	HY-8000	HY-8200
Appearance					
W×H×D(mm)		96.0×96.0×125.0	96.0×96.0×125.0	72.0×72.0×110.0	48.0×48.0×100.0
Input	Thermocouple input	TC-K			
	Reference junction compensation accuracy	±1.5 °C (within -10 ~ 50 °C)			
	RTD input	Pt100 Ω			
	Allowable wiring resistance	10 Ω or less, but the resistance between 3 wires should be the same)			
	Input sampling cycle	500 ms			
Control output	Output type	Relay : 1C, 250 V a.c. 5A			
	Control type	ON/OFF control, Proportional control (Selective by Internal DIP switch)			
	Proportional band	1 ~ 10 °C			
	Manual reset (MR)	0 ~ 100 %			
	Control cycle	20 sec			
	Hysteresis	2 °C			
Alarm output	Output acting	Reverse acting(heating)			
	Alarm type	Model HY-8200 only. High limit alarm			
	Output type	Relay : 1C, 250 V a.c. 5A			
Power supply	Hysteresis	2 °C			
	Power supply voltage	100 - 240V a.c. 50 - 60Hz			
	Voltage fluctuation rate	± 10% of power supply voltage			
	Insulation Resistance	Min. 20 MΩ, 500 V d.c.			
	Dielectric strength	3,000 V a.c., 50/60 Hz for 1 minute (between 1st and 2nd terminal)			
Power consumption		2.1VA	2.5VA	2.6VA	3.6VA
Display accuracy		±1% of FS ±1 Digit			
Ambient temperature/humidity		0 ~ 50 °C, 35 ~ 85 % RH (without condensation)			
Storage temperature		-25 ~ 65 °C			
Weight (g)		156	164	222	232

Suffix code

Model	Code						Description
HY-	<input type="checkbox"/>	<input type="checkbox"/>	<input type="checkbox"/>	<input type="checkbox"/>	<input type="checkbox"/>	<input type="checkbox"/>	Digital temperature controller
Description	48						48(W) X 48(H) mm
	72						72(W) X 72(H) mm
	8000						96(W) X 96(H) mm
	8200						96(W) X 96(H) mm
Input	K						K thermocouple
	P						RTD, Pt 100 Ω (IEC)
Control output	M						Relay contact output
Alarm output	N						None
	O						High alarm (Only for HY-8200 model)
Control direction	R						Reverse action (Heating control)
Power supply voltage	A						100 - 240 V a.c. 50 - 60 Hz
Range code	<input type="checkbox"/>						Refer to the range and input code

Range and input code chart

Classification	Code	Input	Range (°C)			
			HY-48	HY-72	HY-8000	HY-8200
Thermocouple	04	TC-K	0 ~ 399			
	12		-	0 ~ 1199		
RTD	02	Pt100 Ω	0 ~ 199			
	04		0 ~ 399			

DF2

UPGRADE

Specifications

Model		DF2
Appearance		
W×H×D(mm)		48.0 × 96.0 × 62.5
Input	Thermocouple input	TC-K
	Reference junction compensation accuracy	±1.5°C (within -10 ~ 50 °C)
	RTD input	Pt100 Ω
	Allowable wiring resistance	10 Ω or less, but the resistance between 3 wires should be the same)
	Input sampling cycle	500 ms
Control output	Output type	Relay : 1C, 250 V a.c. 5A
	Control type	ON/OFF control, Proportional control (Selective by Internal DIP switch)
	Proportional band	1 ~ 10 °C
	Manual reset (MR)	0 ~ 100 %
	Control cycle	20 sec
	Hysteresis	2 °C
	Output acting	Reverse acting(heating)
Power supply	Power supply voltage	100 - 240 V a.c. 50 - 60 Hz
	Voltage fluctuation rate	± 10% of power supply voltage
	Insulation Resistance	Min. 20 MΩ, 500 V d.c.
	Dielectric strength	3,000 V a.c., 50/60 Hz for 1 minute (between 1st and 2nd terminal)
	Power consumption	2.4 VA
Display accuracy		± 1% of FS ± 1 Digit
Ambient temperature/humidity		0 ~ 50 °C, 35 ~ 85% RH (without condensation)
Storage temperature		-25 ~ 65 °C
Weight (g)		156

New product
High function
Programmable Temperature Humidity
Thermal shock Test control
Multi-channel
Economy Ignorance For freezer
Indicator

Suffix code

Model	Code	Description
DF	<input type="checkbox"/> <input type="checkbox"/> <input type="checkbox"/> <input type="checkbox"/> <input type="checkbox"/> <input type="checkbox"/> <input type="checkbox"/> <input type="checkbox"/>	Economical Digital Temperature Controller
Appearance	2	48(W) X 96(H) mm
Input	K	K thermocouple
	P	RTD Pt100 Ω (IEC)
Control output	M	Relay output
Alarm output	N	None
Control operation	R	Reverse action (heating control)
Power supply voltage	A	100 - 240 V a.c. 50-60 Hz
Range code	<input type="checkbox"/>	Refer to "Range and input code chart"

Range and input code chart

Classification	Code	Input	Range (°C)
Thermocouple	04	TC-K	0 ~ 399
	12		0 ~ 1199
RTD	02	Pt100 Ω	0 ~ 199
	04		0 ~ 399

TEMPERATURE CONTROLLER

HY-1000, HY-2000

UPGRADE

Specifications

Model	HY-1000	HY-2000
Appearance		
W×H×D(mm)	72.0×72.0×109.2	96.0×96.0×103.9
Power supply voltage	110 V a.c. / 220 V a.c. 60 Hz	
Voltage variation rate	Rated Voltage ± 10 %	
Power consumption	Approx. 3 VA max	
Input	Thermocouple, Resistive	
Control method	Proportional control	
Setting method	Analog Setting	
Display method	Non-Display	
Control output	Relay : 1 C, 277 V a.c. 6 A	
Setting accuracy	Within ± 2.0 % of Max. Range	
Proportional band	3 % of Max. Range (fixed)	
Proportional cycle	Relay Output : Approx. 20 sec	
External input resistance	<ul style="list-style-type: none"> • Thermocouple : Below 100 Ω • Resistive : Below 5 Ω Per 1 Wire (The resistance of each wire should be the same.) 	
Dielectric strength	2000 V a.c. 60 Hz for 1 min	
Relay life expectancy	<ul style="list-style-type: none"> • Mechanical : Min.10 millions times. • Electrical : Min. 100 thousands times. (277 V a.c. 6 A Resistive load) 	
Ambient temperature · humidity	0 ~ 50 °C, 35 ~ 85% R.H (Without condensation)	
Weight (g)	• HY-1000 : 210 • HY-2000 : 270 ※ Including brackets	

Suffix code



Model	Code	Description
HY-	<input type="checkbox"/> - <input type="checkbox"/> <input type="checkbox"/> <input type="checkbox"/> <input type="checkbox"/> <input type="checkbox"/> <input type="checkbox"/>	Analog temperature controller
Appearance	1000	72 mm x 72 mm
	2000	96 mm x 96 mm
input	K	TC K
	P	Pt 100
Control output	M	Relay contact output
Control operation	R	Reverse action (heating) control
Power	A	110 V a.c. / 220 V a.c.
Range code		See range code table

Range and input code chart

Division	Code	Range (°C)
Thermocouple	04	0 ~ 400
	12	0 ~ 1200
RTD	02	0 ~ 200
	04	0 ~ 400

ND4

Specifications

Model		ND4	ND4(For socket)
Appearance			
W×H×D(mm)		48.0×48.0×79.5	48.0×48.0×78.0
Input	Thermocouple	K, J (J Type is for HY-2000 only)	
	RTD	Pt100 Ω(IEC751)	
	Allowable signal source resistance	Max. 100 Ω (thermocouple input)	
	Lead wire allowable resistance	RTD max. 10 Ω. (but the resistance among 3 lines should be same)	
Control functions and output	Control type	Proportional control, ON/OFF control (by suffix code)	
	Control operation	Reverse action or direct action (by suffix code)	
	Setting range	Same as input range chart	
	Proportional band	3 % of FS(Fixed)	
	Proportional period	Approx. 25 ~ 30 sec (Relay output), Approx. 2 ~ 4 sec (voltage output (SSR))	
	Hysteresis	Approx. 2 % of FS, fixed (ON/OFF control, 400 °C standard)	
	Input disconnection detection	Output OFF when range is over	
	Control output	Relay (1 c, 250 V a.c., 3 A resistive load)	
Power voltage		110/220 V a.c. 60 Hz (But for ND4, 110 V a.c. or 220V a.c. are separated)	
Voltage fluctuation rate		±10 % of power voltage	
Power consumption		Max. 3 VA	
Dielectric strength		2000 V a.c. 50/60 Hz for 1 min (Between different live parts)	
Ambient temperature & humidity		0 ~ 50 °C, 35 ~ 85 % RH (without condensation)	
Storage temperature		-25 ~ 65 °C	
Weight (g)		200	

New product
High function
Programmable Temperature Humidity
Thermal shock Test control
Multi-channel
Economy Ignorance For freezer
Indicator

Suffix code

Model	Code	Content
ND4	<input type="checkbox"/> <input type="checkbox"/> <input type="checkbox"/> <input type="checkbox"/> <input type="checkbox"/>	Temperature Controller Without Indicator
Control type	F	ON/OFF control (2 position control)
	P	Proportional control
Input	K	K thermocouple
	P	RTD Pt100 Ω(IEC751)
Control output	M	Relay
Control operation	R	Reverse action (Heating control)
	D	Direct action (Cooling control)
Range code		Refer to "Range and input code chart"
Terminal structure	T	Terminal type

※ Specify the power voltage of ND4 separately (110 V a.c. or 220 V a.c.)

Range and input code chart

Code	ND4	
	Input	Range (°C)
1	Pt	-50 ~ 50
2	Pt	-100 ~ 100
3	Pt	0 ~ 100
5	Pt, K	0 ~ 200
6	Pt, K	0 ~ 300
7	Pt, K	0 ~ 400

TEMPERATURE CONTROLLER

BR6A

Specifications

Model	BR6A	
Appearance		
W×H×D(mm)	74.9×32.9×69.3	
Power consumption	Max. 5 VA (220 V a.c. 60 Hz)	
Input sensor	Hanyoung Nux exclusive sensor (TH-570N) ※ Thermistor (-50.0 ~ 150.0 °C)	
Accuracy	±1 % of FS ±1 Digit	
Control output (Main output)	Relay output	Contact configuration: 1c, 250 V a.c. 5A (resistive load)
	SSR	10 V d.c. min (load resistance min. 500 Ω)
Alarm / Defrost	Relay	Contact configuration: 1c, 250 V a.c. 5A (resistive load)
Control operation	Proportional operation (P control), ON/OFF operation	
Setting method	Set, increase, decrease, digital method by shift key	
Other features	Defrost timer, alarm function, heating/cooling dual usage	
Ambient temperature & humidity	0 ~ 50 °C, 35~85 % RH (Without condensation)	
Line resistance	Max. 10 Ω for 1 wire	
Weight	120	

Suffix code

Model	Code	Content
BR6A -	<input type="checkbox"/> <input type="checkbox"/> <input type="checkbox"/> <input type="checkbox"/> <input type="checkbox"/>	Digital Temperature Controller (Proportional control, ON/OFF control selectable by setting)
Input	N	Hanyoung Nux exclusive sensor (TH-570N) ※ Thermistor
Control output	M	Relay Contact outputs
	S	SSR output (Voltage pulse 12 V d.c.)
Option	0	None (basic specifications: alarm output 1 contact)
	1	Communication (RS-485, MODBUS ASCII / RTU)
Power voltage	P4	100-240 V a.c. 50/60 Hz
LED color	W	White LED
	R	Red LED

BR6 CE

Specifications

Model	BR6	
Appearance		
W×H×D(mm)	77.0×35.0×70.5	
Power voltage	100-240 V a.c. 50/60 Hz, 10-24 V a.c. 50/60 Hz or 10-24 V d.c.	
Power consumption	Max. 5 VA (220 V a.c. 60 Hz)	
Input sensor	Hanyoung Nux exclusive sensor (TH-540N) ※ Thermistor (NTC) (-40.0 ~ 90.0 °C)	
Accuracy	±1 % of FS ±1 digit	
Control output (Main Output)	Relay output	Contact configuration: SPDT, 250 V a.c., 5 A (resistive load)
	SSR	Approx. 5 V d.c. (load resistance min. 500 Ω) max. approx. 50 mA
Control type	ON / OFF, Proportional control selectable by setting	
Setting method	Set, increase, decrease, digital method by key	
Other features	Defrost timer, alarm function, heating / cooling dual usage	
Ambient temperature & humidity	0 ~ 50 °C, 35 ~ 85 % RH (Without condensation)	
Weight (g)	116	

Suffix code

Model	Code	Content
BR6-	<input type="checkbox"/> <input type="checkbox"/> <input type="checkbox"/> <input type="checkbox"/>	Digital Temperature Controller (basic specifications: alarm output 1 contact)
Control type	F	ON/OFF, Proportional control selectable by setting
Input	N	Hanyoung Nux exclusive sensor (TH-540N) ※ Thermistor
Control output	M	Relay
	S	SSR (Voltage pulse output 5 V d.c.)
Power voltage	P3	10-24 V a.c. 50/60 Hz or 10-24 V d.c.
	P4	100-240 V a.c. 50/60 Hz

ED6

Specifications

Model	ED6	
Appearance		
W×H×D(mm)	77.0×35.0×70.5	
Power voltage	100-240 V a.c. 50/60 Hz, 10-24 V a.c. 50/60Hz or 10-24 V d.c.	
Power consumption	5.5 VA	
Input sensor	K, Pt100 Ω, 4-20 mA d.c., 1-5 V d.c.	
Accuracy	± 0.5 % of FS ±1 Digit	
Control output (Main Output)	Relay output	Contact configuration: 1 c, 250 V a.c. 5 A (resistive load)
	SSR	Approx. 5 V d.c. (load resistance min. 500 Ω) max. approx. 50 mA
Control type	Proportional control, ON/OFF control selectable by setting	
Setting method	Set, increase, decrease, digital method by key	
Other features	Sub output (alarm, defrost timer), heating / cooling dual usage	
Ambient temperature & humidity	0 - 50 °C, 35 ~ 85 % RH (Without condensation)	
Weight (g)	116	

New product
High function
Programmable Temperature Humidity
Thermal shock Test control
Multi-channel
Economy Ignorance For freezer
Indicator

Suffix code

Model	Code	Content
ED6	<input type="checkbox"/> <input type="checkbox"/> <input type="checkbox"/> <input type="checkbox"/> <input type="checkbox"/>	Digital Temperature Controller
Control type	F	ON/OFF, Proportional control selectable by setting
Input	K	Thermocouple K
	P	RTD Pt100 Ω (IEC751)
	C	4-20 mA d.c. (External resistance 250 Ω installation), 1-5 V d.c.
Control output	M	Relay output
	S	SSR (Voltage pulse output 5 V d.c.)
Power voltage	A	Alarm or defrost timer (Alarm or Defrost)
	N	None
Power voltage	P3	10-24 V a.c. 50/60Hz or 10-24 V d.c.
	P4	100-240 V a.c. 50/60 Hz

HD6

Specifications

Model	HD6	
Appearance		
W×H×D(mm)	77.0×35.0×70.5	
Power voltage	100-240 V a.c. 50/60 Hz	
Power consumption	Max. 2 VA	
Input sensor	TH-540N (103ET: -40.0 ~ 90.0 °C, 2 m ~ 20 m)	
Accuracy	±1 % + 1 Digit of display value	
Control output (relay contact)	OPEN OUT: 250 V a.c. 5 A, CLOSE OUT: 250 V a.c. 5 A	
Control type	ON/OFF control (control by temperature and time)	
Setting method	Digital method by FND and button	
Other features	Green house operation / window closing motor control output	
Ambient temperature & humidity	0 ~ 50 °C, 35 ~ 85 % RH (Without condensation)	
Weight(g)	116	

Suffix code

Model	Code	Content
HD6	<input type="checkbox"/> <input type="checkbox"/> <input type="checkbox"/> <input type="checkbox"/>	Cost-Effective Digital Temperature Controller
Control type	F	ON/OFF control
Input	N	Hanyoung Nux exclusive sensor (TH-540N) ※ Thermistor
Control output	M	Relay
Power voltage	P4	100-240 V a.c. 50/60 Hz

TEMPERATURE CONTROLLER

BK3

Specifications

Model		BK3
Appearance		
W×H×D(mm)		96.0×48.0×100.2
Input sensor	Thermocouple	K
	RTD	Pt100 Ω(IEC)
Input sampling time		500 ms
Input display resolution		Usually less than indication value 1 °C (0.1 °C)
Input impedance		1 MΩ (thermocouple)
Allowable signal source resistance		Thermocouple (100 Ω max)
Allowable wiring resistance		RTD (10 Ω max) but resistances among 3 wires should be same
Allowable input voltage		Within ±10 V d.c. (thermocouple, RTD)
Display accuracy		±0.5 % of FS ±1 Digit (but, if less than 599 °C with R input, warranty not applied)
Insulation resistance		20 MΩ min (500 V d.c.)
Dielectric strength		2,000 V a.c. 50/60 Hz, for 1 min, (between the different recharging part)
Power Supply Voltage		110/220 V a.c. 50/60 Hz (Dual usage)
Voltage fluctuation		±10 % of power supply voltage
Power consumption		4 VA max
Ambient temperature		0 ~ 50 °C
Storage temperature		-25 ~ 65 °C
Vibration resistance		10 - 50 Hz, Peak amplitude for 2 hrs each in X, Y and Z direction
Shock resistance		300 m/s ² each in X, Y and Z direction for 3 times
Weight		350 g

Suffix code

Model	Code	Content
BK3-	<input type="checkbox"/>	Digital Temperature Indicator
Input	K	K thermocouple
	K1	(refer to the range and input code chart)
	P1	Resistance Temperature Detector(RTD)
	P2	Pt100 Ω (refer to the range and input code chart)

Range and input code chart

Classification	Code	Input	Range (°C)
Thermocouple	K	K thermocouple	0 ~ 1,300 °C
	K1		0.0 ~ 200.0
RTD	P1	Pt100 Ω	-199 ~ 600 °C
	P2		-199.9 ~ 199.9 °C

BK6-M

Specifications

Model		BK6-M	
Appearance			
W×H×D(mm)		72.0×36.0×87.5	
Input	Input	Multi Input selectable by setting	
	Thermocouple	K, J, E, T, R, B, S, L, N, U, W, PL2	
	RTD	Pt 100 Ω(IEC 751), KPt 100 Ω	
	Input sampling cycle	500 ms	
	DC voltage	1-5 V d.c. (4-20 mV d.c.), -10-20 mV d.c., 0-100 mV d.c.	
	Input impedance	● Thermocouple and DC voltage input (mV) : min. 1 MΩ ● DC voltage input(V) : approx. 1 MΩ	
	Allowable signal source resistance	Thermocouple (max. 100 Ω) DC voltage (max. 2 kΩ)	
	Allowable wiring resistance	RTD max. 10 Ω (but the resistance among 3 lines should be same)	
	Allowable input voltage	Within ±10 V (thermocouple, RTD, DC voltage (mV)). within ±20 V (DC voltage (V))	
	Input correction	Correction by internal parameter	
Reference contact compensation error	±2.0 °C (0 ~ 50 °C)		
Performance	Accuracy	Thermocouple	±0.5 % of FS ±1 Digit)
		RTD	±0.5 % of FS ±1 Digit)
		DC voltage / current	±0.5 % of FS ±1 Digit)
	Insulation resistance	Min. 20 MΩ (500 V d.c.)	
	Dielectric strength	2,000 V a.c. 50/60 Hz 1 minute (Between different live parts)	
Power voltage	100-240 V a.c. 50/60 Hz		
Voltage fluctuation rate	±10 % of power voltage		
Power consumption	Max. 4 VA		
Ambient temperature & humidity	0 ~ 50 °C, 35 ~ 85% RH (Without condensation)		
Storage temperature	-25 ~ 65 °C		
Weight (g)	120		

New product
High function
Programmable Temperature Humidity
Thermal shock Test control
Multi-channel
Economy Ignorance For freezer
Indicator

Suffix code

Model	Code	Content
BK6-M	□	Multi InputDigital Temperature Indicator
Option	0	None
	1	RET (Retransmission output 4 - 20 mA d.c.)

Range and input code chart

Classification	Code	Input	Range (°C)	Accuracy	비고	
Thermocouple(TC)	1	K	*2	-200 ~ 1370	±0.5 % of FS ±1 digit	*1) 0 to 400°C range: ±10% of FS ±1 digit *2) Below 0°C: ±1.0 % of FS ±1 digit *3) -150.0 to 150.0°C below: ±1.0% of FS ±1 digit *4) When using current input, select code number "30" and attach a 250 Ohm 0.1% resistance to the input signal terminal.
	2	K	*2	-199.9 ~ 999.9		
	3	J	*2	-199.9 ~ 999.9		
	4	E	*2	-199.9 ~ 999.9		
	5	T	*2	-199.9 ~ 400.0		
	6	R	*2	0 ~ 1700		
	7	B	*1	0 ~ 1800		
	8	S		0 ~ 1700		
	9	L	*2	-199.9 ~ 900.0		
	10	N		-200 ~ 1300	±1.0 % of FS ±1 digit	
	11	U	*2	-199.9 ~ 400.0	±0.5 % of FS ±1 digit	
	12	W		0 ~ 2300		
	13	Platinel II		0 ~ 1390		
RTD (RTD)	20	KPt100 Ω	*3	-199.9 ~ 500.0	±0.5 % of FS ±1 digit	
	21	Pt100 Ω	*3	-199.9 ~ 640.0		
Voltage/Current (VDC / mV DC)	30	5 V d.c.		1-5 V d.c.	±0.5 % of FS ±1 digit	
	32	20 mV d.c.		10 - 20 mV d.c.		
	33	100 mV d.c.		0 - 100 mV d.c.		
DC Current	30	20 mA d.c.	*4	4-20 mA d.c.		

GRAPHIC RECORDERS

GR200A CE

UPGRADE

Specifications

Model		GR200A
Appearance		5.7" 
W×H×D(mm)		145.0×145.0×173.5
Power input	Power voltage	100 - 240 V a.c. Voltage fluctuation rate ±10 %
	Power frequency	50 - 60 Hz
	Power consumption	25 VA max
	Maximum internal fuse ratings	250 V a.c.
Insulation resistor		20 MΩ between the power terminal and the FG terminal or 500 V d.c.
Number of channels		2, 4, 8, 12 (Refer to the type configuration)
Input type		<ul style="list-style-type: none"> ▪ 12 thermocouples (K, J, E, T, R, B, S, L, N, U, Wre 5-26, PL-II) ▪ 2 thermoresistors (Pt-100, KPt-100) ▪ DC voltage 4 types (-10 - 20 mV, 0 - 100 mV, 1 - 5V, 0 - 30 V) ※ The current input (4 - 20 mA d.c.) is available when you use resistance 250 Ω (0.5 W / 0.1 %) on input terminals.
Sampling cycle		250 ms
Current to measure the thermoresistor (RTD)		About 0.21 mA
Input resistor		Thermocouple : More than 1 MΩ, VDC : More than 1 MΩ
Allowable wiring resistor		<ul style="list-style-type: none"> ▪ Thermocouple : Less than 200 Ω ▪ VDC : Less than 2 kΩ ▪ Thermoresistor : Maximum 100 Ω/wire (The RTD is up to 10 Ω/wire for the range of -100.00 - .150.00)
Impact of the wiring resistor		Thermoresistor : ±0.3 °C/10 Ω (The 3 lines have the same wiring resistors)
Allowable input voltage		<ul style="list-style-type: none"> ▪ Thermocouple : Less than ±10 V d.c. ▪ VDC : Less than ±33 V d.c.
Accuracy		±0.15 % of F.S, ±1 digit (Except the RJC temperature error) ※ Refer to the input table
RJC temperature error		±1.5 °C (0 ~ 50 °C)
Sensor short detection (Burn-out)		UP-Scale during disconnection
Maximum input		4
Input method		No voltage contact input
On/Off detection resistor		Consider on less than 1 kΩ minimum and off larger than 10 kΩ
Minimum detection time		0.25 second
Maximum number of outputs		12
Output type		Relay output
Maximum ratings		5 A 250 V a.c., 5 A 30 V d.c.
Recommended ratings		2 A 250 V a.c., 2 A 30 V d.c.
Relay life		50,000 times at the maximum ratings, 100,000 times at the recommended ratings
Ambient temperature		-20 ~ 70 °C
Temperature change		Less than 20 °C/h
Ambient humidity		5 - 95 % RH (no condensation)
Ambient temperature		0 ~ 50 °C
Temperature change		10 °C/h or below
Ambient humidity		20 ~ 90 % RH (no condensation)
Magnetic field		400 A/m or less
Altitude		Less than 2,000 m above the sea level
Weight		About 1.32 kg

Suffix code

Model	Code	Content
GR200A -	<input type="checkbox"/> <input type="checkbox"/> <input type="checkbox"/>	Touch Screen Graphic Recorder
Input channel	2	2 channels
	4	4 channels
	8	8 channels
	12	12 channels
External contact input & output (DI / DO)	N	None
	1	DI 2 contacts + DO 6 contact
	2	DI 4 contacts + DO 12 contacts
Communication function	1	RS 422/485 + ETHERNET

RT9N

Specifications

Model	RT9N
Appearance	
W×H×D(mm)	96.0×96.0×100.0
Power voltage	100-240 V a.c. (±10%), 50/60 Hz
Power consumption	Max. 15 W, max. 20 VA
Sampling cycle	250 ms
Input	<ul style="list-style-type: none"> ● Thermocouple : K, J, E, T, R, S, B, L, N, U, WRe 5 - 26, PL- II ● RTD : Pt 100 Ω, KSPT 100 Ω ● DC voltage : 1-5 V d.c., 0-10Vd.c., -10-20 mV d.c., 0-100 mV d.c. (freescale type)
Input display resolution	Basically below the decimal point of the measuring range table
Input impedance	Thermocouple and DC voltage input (mV): min. 1 MΩ. DC voltage input(V): approx. 1 MΩ
Alarm	Relay output (AL1,AL2)
Allowable signal source resistance	Thermocouple (max. 250 Ω). DC voltage (max. 2 kΩ)
Allowable wiring resistance	RTD max. 10 Ω. (but the resistance among 3 lines should be same)
Allowable input voltage	Within ±10 V (thermocouple,RTD,DC voltage (mV)) Within ± 20 V (DC voltage (V)).
Noise removal rate	NMRR (normal mode): 40 dB min , CMRR (common mode): 120 dB min (50/60 Hz ± 1 %)
Applicable standard	Thermocouple/RTD (KS/IEC 751/DIN)
Reference contact compensation error	±1.5 °C (15 ~ 35 °C 사이), ±2.0 °C (0 ~ 50 °C range)
Accuracy	Indication and record accuracy: ±0.5 % (Full Scale)
Record	<ul style="list-style-type: none"> ● Recording paper check: If there is no recording paper, the P-END lamp on the front display window lights and recording stops ● Printing method: 203 dpi (8.0 dots/mm) 384 dots per line ● Recording paper speed: (20, 30, 60, 120, 180, 300, 600, 900) mm/h ● Measurement point: 1 contact ● Response time: varies according to recording speed ● Recording method: Thermal line ● Recording paper: width 57.5 mm, length approx. 16 m

2~12 channels
Touch panel

2 channels
For recording
paper

Suffix code

Model	Code	Content
RT9N-	<input type="checkbox"/> <input type="checkbox"/> <input type="checkbox"/>	2-Channel Temperature Controller/Recorder
Control type	0	Temperature recorder only
	1	Temperature recorder and controller
Number of channels	1	1 channel
	2	2 channel
Option	0	None (AL1 built-in)
	1	AL2
	2	AL2, RS485 communication
	3	RS485 communication

1-Channel type only

Range and input code chart

Classification	NO.	Input type	Indication Symbols	Range (°C)	Accuracy	비고
Thermocouple (TC)	1	K	*2 K	-200 ~ 1370	±0.5% of FS ±1 digit	<p>⚠ Caution Measurement Input Wiring</p> <ul style="list-style-type: none"> - Disconnect the regulator body and external supply power when wiring the measurement input lines. - Pay attention to the polarity of the input and connect the input signal between the power circuit and the ground circuit. - Please use SHIELD-treated wiring for the input and ground SHIELD to 1 point. <p>Digit is the minimum display</p> <ul style="list-style-type: none"> *1) 0 ~ 400 °C range : ±10 % of F.S ±1 digit *2) Max. 0 °C : ±1.0 % of F.S ±1 digit *3) -150.0 ~ 150.0 °C range : ±1.0 % of F.S ±1 digit *4) When using current input, select code number "30" and attach a 250 Ohm 0.1% resistance to the input signal terminal. <p>FS from the minimum to the maximum of each range measurable range.</p> <p>When selecting the input type, the selection number is set in the value display window (SV). However, do not set a number that does not have an input signal selection number.</p>
	2	K	*2 K	-199.9 ~ 999.9		
	3	J	*2 J	-199.9 ~ 999.9		
	4	E	*2 E	-199.9 ~ 999.9		
	5	T	*2 T	-199.9 ~ 400.0		
	6	R	*2 r	0 ~ 1700	±0.5% of FS ±1 digit	
	7	B	*1 b	0 ~ 1800		
	8	S	S	0 ~ 1700	±0.5% of FS ±1 digit	
	9	L	*2 L	-199.9 ~ 900.0		
	10	N	n	-200 ~ 1300		
	11	U	*2 U	-199.9 ~ 400.0	±1.0% of FS ±1 digit	
	12	W	w	0 ~ 2300		
	13	Platinel II	PLII	0 ~ 1390		
RTD	20	KSPT100 Ω	*3 KSP	-199.9 ~ 500.0	±0.5% of FS ±1 digit	
	21	Pt100 Ω	*3 PI	-199.9 ~ 640.0		
Direct voltage (VDC/mV DC)	30	1-5 V d.c.	dCB	Scaling range SL-L : -1999 SL-H : 9999	±0.5% of FS ±1 digit	
	31	0-10 V d.c.	dCB			
	32	-10 ~ 20 m V d.c.	dCnB			
	33	0-100 m V d.c.	dCnB			
Direct current	30	4-20 mA d.c.	*4 dCB	4-20 mA d.c.		

DIGITAL COUNTER/TIMERS

LC series



Specifications

Model	LC6	LC4	LC3	LC7
Appearance				
W×H×D(mm)	72.0×36.0×84.1	48.0×48.0×79.5	96.0×48.0×71.1	72.0×72.0×92.9
Power voltage	100-240 V a.c. 50/60 Hz, 24-48 V a.c. 50/60 Hz or 24-48 V d.c. (Voltage fluctuation rate: ±10 %)			
Power consumption	2-stage setting: max. 12 VA. 1-stage setting: max. 11 VA			
Character height	Counting unit (10.5 mm), Setting unit (6.7 mm)	6-digit: counting unit (10.8 mm), setting unit (8 mm) 4- digit: counting unit (14 mm), setting unit (8.5 mm)	Counting unit (14.5 mm), Setting unit (10 mm)	Counting unit (17.2 mm), Setting unit (12.5 mm)
Maximum counting speed	1 CPS / 30 CPS / 1 KCPS / 10 KCPS			
Power outage compensation	10 years (using non-volatile memory)			
Input	<ul style="list-style-type: none"> ● Selection of input method by external switch (voltage input / non-voltage input) ● Counter : composed of CP1, CP2, RESET, BATCH-RESET ● Voltage input : HIGH level (5 - 30 V d.c.), LOW level (0 - 2 V d.c.), input resistance (about 4.5 kΩ) ● Timer : composed of START, INHIBIT, RESET ● Non-voltage input : impedance during short-circuit (max. 1 kΩ), residual voltage during short-circuit (max. 2 V d.c.) 			
Minimum input signal time	1 ms / 20 ms (START, INHIBIT, RESET inputs)			
External power supply	Max. 12 V d.c. 100 mA			
ONE SHOT output	0.01 ~ 99.99 SEC			
Control output	1-Stage setting	OUT (SPST, 1a)	OUT (SPDT, 1c)	OUT (SPDT, 1c)
	2-Stage setting	OUT1 (SPST, 1a), OUT2 (SPDT, 1c) * OUT2 of LC6-P62C: SPST configuration		
	Capacity	SPDT: NC (250 V a.c. 5A), NO (250 V a.c. 2A) SPST: 250Va.c. 5A, resistive load		
	1-Stage setting	NPN circuits (OUT, BAT.O) * LC4-P61C/P41C models NPN 1 circuit configuration		
	2-Stage setting	-	NPN 2 circuits (OUT1, OUT2)	NPN 2 circuits (OUT1, OUT2)
Capacity	Open collector, 30 V d.c. 100 mA max			
Timer operation error	Power start: max. ±0.01 % ±0.05 sec, Reset start: max. ±0.01 % ±0.03 sec			
Communication	<ul style="list-style-type: none"> ● Protocol : Modbus-RTU ● Synchronization: Asynchronous ● Max. connections : 31 (Address:1 ~ 127) ● Start bit : 1 bit (Fixed) ● Data bit : 8 bit ● Communication speed : 2,400 / 4,800 / 9,600 / 19,200 / 38,400 bps ● Communication type : RS485 (2-Wire half-duplex) ● Effective distance : Max. within 800 m ● Response waiting time : 5 ~ 99 ms ● Stop bit : 1 bit (Fixed) ● Parity bit : None / Odd / Even 			
Insulation Resistance	Min. 100 MΩ (500 V d.c.) conductive terminal - unfilled metal			
Dielectric strength	2,000 V a.c. 60 Hz for 1 min (Different live part terminals)			
Noise immunity	Square-wave noise by noise simulator (1 μs pulse every 16 ms), ±2000 V (pulse width 1 μs)			
Vibration resistance	10 - 55 Hz, single amplitude 0.5 mm, 3-axis each direction, 2 h			
Relay life	Electrical	Min. 50,000 times		
	Mechanical	Min. 10 million times		
Degree of protection	IP66 (IEC 60529) (Product front)			
Storage temperature	-20 ~ 65 °C			
Ambient temperature & humidity	-10 ~ 55 °C, 35 ~ 85 % RH (Without condensation)			
Certified	CE			
Weight (g)	196	140	143	222



Suffix code

Model	Code	Content
LC	<input type="checkbox"/> <input type="checkbox"/> <input type="checkbox"/> <input type="checkbox"/> <input type="checkbox"/> <input type="checkbox"/>	LCD Counter / Timer
Appearance	3	96(W) × 48(H) mm
	4	48(W) × 48(H) mm
	6	72(W) × 36(H) mm
	7	72(W) × 72(H) mm
Type	P	Preset Counter / Timer
Display digits	4	4 Digit display (9999) ※ LC4 only
	6	6 digit display (999999)
Setting stages	1	1 Stage setting
	2	2 Stage setting
Sub output	N	No sub output
	C	RS485 (MODBUS-RTU)
Power voltage	A	100-240 V a.c. 50/60 Hz
	D	24-48 V a.c. 50/60 Hz or 24-48 V d.c.

GF series

UPGRADE

Specifications

Model		GF7A	GF4A	GF4A-□□□S
Appearance				
W×H×D(mm)		72.0×72.0×75.0	48.0×48.0×79.8	48.0×48.0×63.3
Power supply voltage		100 - 240 V a.c. 50/60 Hz (Voltage fluctuation rate : ± 10 %)		
Power Consumption		P62 (7.6 VA), P61 (6.6 VA) T6 (5.6 VA) P42 (7.3 VA), P41 (6.6 VA)	P41 (6.4 VA) T4 (5.6 VA)	P41S (5.9 VA) T4S (5.4 VA)
Display method		White 7 segment LED		
Character size		P62/P61/T6 (11.5 X 5.2 mm) P42/P41 (13.6 X 7.8 mm)	8.5 X 5.0 mm	
Counting speed		1 / 30 / 1k / 5k cps		
Blackout compensation		10 Years (nonvolatile memory used)		
Return time		500 ms or less		
Timer operation error		Power start : ± 0.01 % ± 0.05 seconds or less (ratio to setting value)		
Input		<ul style="list-style-type: none"> Input method selection by external switch (voltage input / no - voltage input) Counter (composed of CP1, CP2, RESET), timer (composed of INHIBIT, RESET) Voltage input : HIGH level (5 V - 30 V d.c.), LOW level (0 V - 2 V d.c.), input resistance (about 4.7 kΩ) No - voltage input : Impedance in case of short circuit (1 kΩ or less), residual voltage in case of short - circuit (2 V d.c. or less) 		
Min. input signal time		20 ms or more (RESET, INHIBIT input)		
One-shot output time	1st stage	0.5 seconds fixed		
	2st stage	0.05 to 5.8 seconds		
External power supply		12 V d.c. 100 mA max.		
Control output	Contact	1st stage	OUT (SPDT, 1c)	
		2st stage	OUT1 (SPDT, 1c), OUT2 (SPDT, 1c)	
		Capacity	SPDT : NC (250 V a.c. 2 A, 250 V a.c. 5 A), NO (250 V a.c. 5 A), Resistance load	
	Non-contact	1st stage	OUT (NPN Open collector)	
		2st stage	OUT1, OUT2 (NPN 2 open collector circuits)	
		Capacity	30 V d.c. 100 mA max.	
Relay life		Electrical (more than 50,000 times), Mechanical (more than 10 million times)		
Insulation Resistance		100 MΩ or more (based on 500 V d.c. mega)		
Dielectric strength		2,000 V a.c. 60 Hz 1 minute (between the conductive part terminal and the case)		
Noise resistance		Square wave noise by noise simulator ±2,000 V (Pulse width 1 μs)		
Vibration		Durability : 10 · 55 Hz (1 minute cycle), Double amplitude 0.75 mm, X · Y · Z 2 hours each direction Malfunction : 10 · 55 Hz (1 minute cycle), Double amplitude 0.5 mm, X · Y · Z 10 minutes each direction		
Ambient temperature and humidity		-10 ~ 55 °C, 35 ~ 85 % R.H.		
Storage temperature		-20 ~ 65 °C		
Weight (g)		T6 : 150 g P41 : 184 g P61 : 180 g	T4 : 100 g P41 : 108 g	T4S : 84 g P41S : 92 g

New product
Count/Timer

Small LCD
counter

Digital
Counter/
Timer

New product
Timer

Small LCD
Timer

Digital
Twin Timer

Digital
Timer

Weekly/
yearly
Time switch

Timing
Relay

Analog
ON-Delay
Timer

Analog
Twin/Dual
Timer

Analog
Multi
Timer

Star-delta
Timer

Suffix code

Model	Code	Description
GF	□- □ □ □ □	Digital counter/timer
Appearance	4A	48(W) X 48(H) mm
	7A	72(W) X 72(H) mm
Model	P	Preset counter/timer
	T	Total counter/timer
Display digits	6	6 Digit-display (999999) ※ GF7A model only
	4	4 Digit-display (9999)
Control output	2	2 - Stage output ※ GF7A model only
	1	1 - Stage output
	-	No output (Display only)
Terminal structure	S	8 Pin plug ※ GF4A model only
	-	Terminal

DIGITAL COUNTER/TIMERS

LC1 CE

Specifications

Model		LC1	LC1-F
Appearance			
W×H×D(mm)		48.0×24.0×54.0	
Input type		Non voltage input (no indication)	Voltage input (24 - 240 V a.c., 6 - 240 V d.c.)
Power voltage		Lithium battery built-in	
Input operation		Up Count	
Counting speed		1/30/100/ 1K cps	20 cps
Input conditions		<ul style="list-style-type: none"> ● Residual voltage when it breaks : 0.7 V ● Max. impedance when it breaks: max. 10 kΩ ● Min impedance when it opens: min. 1 MΩ 	<ul style="list-style-type: none"> ● HIGH : 24 - 240V a.c. / 6 - 240 V d.c. ● LOW : 0 - 2 V a.c./DC
Reset	Input type	Non-voltage input	
	Minimum signal width	Min. 20 ms	
Battery life		More than 7 years (approx. 25 °C) ※ this is calculated value so it is not certified value (replacing cycle reference value)	
External setting switch		<ul style="list-style-type: none"> ● SW1 : Internal battery ON/OFF, front reset key selectable ● SW2 : Count speed selectable 	SW1 : Internal battery ON/OFF, front reset key selectable
External connection		Terminal Blocks (4P)	
Display method		7 Segment LCD (character height: 8.7 mm)	
Display digits		8 Digits	
Insulation resistance		Min. 100 MΩ (500 V d.c), conductive terminal - unfilled metal	
Dielectric strength		2000 V a.c. 50/60 Hz for 1 min (conductive terminal - unfilled metal)	
Vibration resistance		10 - 55 Hz, Double amplitude 0.75 mm, 3 axes each direction, 2h	
Shock resistance		300 m/s, 3 Axes each direction each 3 times	
Ambient temperature & humidity		-10 ~ 55 °C / 35 ~ 85 % RH (Without condensation)	
Storage temperature		-25 ~ 65 °C	
Degree of protection		IP66 (IEC 60529) (Front side)	
Weight (g)		58	

LT1 CE



Specifications

Model		LT1	LT1-F
Appearance			
W×H×D(mm)		48.0×24.0×54.0	
Input type		Non-voltage input (no display)	Voltage input (24-240 V a.c. / 6-240 V d.c.)
Power voltage		Lithium battery built-in	
Operation type		UP Timer	
Time display		9999 h 59 m 59 s / 99999 h 59.9 m / 999999 h 59 m / 9999999.9 h	
Time accuracy		± 0.01 %	
Input conditions		<ul style="list-style-type: none"> ● Residual voltage when breaks : 0.7 V ● Max. impedance when breaks: max. 10 kΩ ● Min impedance when opens: min. 1 MΩ 	<ul style="list-style-type: none"> ● HIGH : 24-240 V a.c./6-240 V d.c. ● LOW : 0-2 V a.c./0-2.4 V d.c.
Battery life		More than 10 years (approx. 25 °C) ※ This is calculated value so it is not certified value (Replacing cycle reference value)	
External setting switch		● SW1 : Internal battery ON/OFF, front reset key selectable	● SW2 : Time range selection
External connection		Terminal Blocks (4P)	
Display method		7 Segment LCD (Character height : 8.7 mm)	
Display digits		8 Digits	
Insulation resistance		Min. 100 MΩ (500 V d.c), conductive terminal - unfilled metal	
Dielectric strength		2000 V a.c. 50/60 Hz for 1 min (Conductive terminal - unfilled metal)	
Vibration resistance		10 - 55 Hz, double amplitude 0.75 mm, 3 axes each direction, 2h	
Shock resistance		300 m/s, 3 axes each direction each 3 times	
Ambient temperature & humidity		-10 ~ 55 °C / 35 ~ 85 % RH (Without condensation)	
Storage temperature		-20 ~ 65 °C	
Degree of protection		IP66 (IEC 60529) (Front side)	
Weight (g)		58	

LT4 series

NEW

Specifications

Model		LT4 (Socket type)	LT4S (Socket type)
Appearance			
W×H×D(mm)		48.0×48.0×65.7	
Power voltage		24-240 V a.c. 50/60 Hz, 24-240 V d.c. Combined	
Allowable voltage fluctuation rate		±10% of power voltage	
Power consumption		Max. 4 VA (24 - 240 V a.c. 50/60 Hz) Max. 1.6 W (24 - 240 V d.c.)	Max. 4.5 VA (24 - 240 V a.c. 50/60 Hz) Max. 2 W (24 - 240 V d.c.)
Display method		Wide viewing angle negative LCD display	
Display mode		Up display and down display	
Display digits		4 Digits	
Character height		PV display : 14mm, SV display : 8.5mm	
Return time		Max. 100 ms	
External connection		Socket 8-pin	
Operating time range		0.01 sec ~ 9999 hour	
External input	Input signal	-	START, INHIBIT, RESET
	Input method	-	<ul style="list-style-type: none"> ● Non-voltage input ● Impedance during short-circuit: max. 1 kΩ ● Voltage during short-circuit: max. 0.5 V ● Impedance during open: min. 100 kΩ
Minimum input time		-	START, INHIBIT, RESET minimum input signal width 1 ms / 20ms selection
Operating time error		Power START : max. ± 0.01 % ±0.05 sec., Signal START : max. ± 0.005 % ±0.03 sec.	
Control output	Operation mode	POND / PFKF / PFKN / PINT / TWON / TWOF / S-D	SOND / SFKF / SINT / SNFN / SNFF / SOFD / S.OND / S.FKN / S.INT / S.ODR
	Contact configuration	Time limit 2c, instantaneous 1c + time limit 1c	Time limit 1c
	Contact capacity	250 V a.c. 3A resistive load (NO : 5A, NC : 3A)	250 V a.c. 5A resistive load
Relay life		<ul style="list-style-type: none"> ● Mechanical life: min. 10 million times ● Electrical life: min. 100,000 times (250 V a.c. 5A resistive load) 	
Insulation Resistance		Min. 100 MΩ (500 V d.c. Mega standard, conductive terminal - exposed unfilled metal part)	
Dielectric strength		2000 V a.c. 60 Hz for 1 min (Conductive terminal - exposed unfilled metal part)	
Noise immunity		± 2 kV (among operation power terminals, pulse width = 1 us, square wave noise by noise simulator)	
Vibration resistance		10 - 55 Hz (for 1 min) single amplitude 0.5 mm X, Y, Z each direction 2 hours	
Shock resistance		300 m/s ² (30G) X, Y, Z Each direction 3 times	
Degree of protection		IP66 (IEC 60529) (Product front)	
Ambient temperature & humidity		-10 ~ 55 °C, 35 ~ 85 % RH (However, there will be no condensation.)	
Storage temperature		-25 ~ 65 °C	
Certified			
Weight (g)		86	84

New product
Counter/Timer

Small LCD
counter

Digital
Counter/
Timer

New product
Timer

Small LCD
Timer

Digital
Twin Timer

Digital
Timer

Weekly/
yearly
Time switch

Timing
Relay

Analog
ON-Delay
Timer

Analog
Twin/Dual
Timer

Analog
Multi
Timer

Star-delta
Timer



Suffix code

Model	Code	Content
LT4	□	LCD Timer
Control output		Time limit 2c, time limit 1c + instantaneous 1c
	S	Time limit 1c

DIGITAL COUNTER/TIMERS

TT SERIES

Specifications

Model		TT7H	TT4-P42A	TT4-P42B
Appearance				
W×H×D(mm)		72.0×72.0×63.0	48.0×48.0×87.0	48.0×48.0×87.0
Power voltage		220 V a.c. 60Hz	100-240 V a.c. 50/60 Hz	
Allowable voltage fluctuation rate		±10% of power voltage		
Power consumption		Approx. 9.6 VA (with 220 V a.c. 60 Hz)	Max. 9.1 VA (220 V a.c. 60 Hz)	
Display method		ON Time display window: Red FND 4 digits (Character height: 18.7 mm) OFF Time display window: Red FND 4 digits (Character height: 14.5 mm)	PV : Character height 11 mm, SV : Character height 8 mm	
External connection method		Terminal	11-Pin socket	8-Pin socket
Minimum signal time		START: min. 1s	START: min. 20 ms (RST / INH)	-
Control output	Contact configuration	Output: time limit SPDT (1c)		
	Contact capacity	● NO : 250 V a.c. 5 A (Resistive load) ● NC : 250 V a.c. 2 A (Resistive load)		
Relay life	Mechanical	Min. 10 million times		
	Electrical	Min. 100,000 times (250 V a.c. 3A resistive load)		
Dielectric strength		2,000 V a.c. 50/60 Hz for 1 min		
Noise immunity		±2 kV (Between operation power terminals), square wave noise by noise simulator (pulse width = 1μs)		
Insulation Resistance		Insulation Resistance		
Vibration resistance		10 - 55 Hz (1 Minute cycle), peak amplitude 0.75 mm X·Y·Z each direction 1 hour		
Shock resistance		300 m/s ² , X·Y·Z each direction 3 times		
Ambient temperature & humidity		-10 ~ 55 °C, 30 ~ 85 % RH (without condensation)		
Storage temperature		-20 ~ 65 °C		
Weight (g)		300	108	

Suffix code

TT7H

Model	Code	Content
TT7H-	<input type="checkbox"/> <input type="checkbox"/> <input type="checkbox"/> <input type="checkbox"/>	Digital Twin Timer
Settings	P	Preset method
Display digits	4	4 Digit display (9999)
Control output	1	1-Stage output
External connection	A	9-Pin terminal type (external input)

TT4

Model	Code	Content
TT4	<input type="checkbox"/> <input type="checkbox"/> <input type="checkbox"/> <input type="checkbox"/>	Digital Dual Timer
Settings	P	Preset method
Display digits	4	4 Digit display (9999)
Control output	2	2-Stage output
External connection	A	11-Pin socket type
	B	8-Pin socket type

TF4A

UPGRADE

Specifications

Model	TF4A-A	
Appearance		
Power voltage	100 - 240 V a.c. 50/60 Hz	
Voltage fluctuation rate	Power voltage $\pm 10\%$	
Power consumption	3.2 VA	
Display	White 7 segments LED	
Character size	Character height (8.5 mm), Character width (5.0 mm)	
Timer operation	Power On Start	
Return time	500 ms max.	
Timer operation error	<ul style="list-style-type: none"> ● Power start : $\pm 0.01\% \pm 0.05$ seconds or less ● Reset start : $\pm 0.01\% \pm 0.03$ seconds or less 	
Input	<ul style="list-style-type: none"> ● Input method selection by external switch (Voltage input / No voltage input) ● RESET, INHIBIT Composed of input ● Voltage input : HIGH level (5 V - 30 V d.c.), LOW level (0 V - 2 V d.c.), Input resistance (Approx. 4.7 kΩ) ● No voltage input : Impedance in case of short circuit (1 kΩ below), Residual voltage in case of short circuit (2 V d.c. below) 	
Input signal time	20 ms below (RESET, INHIBIT input)	
Control output	Time limit 1c (SPDT) SPDT : NC (250 V a.c. 2 A), NO (250 V a.c. 5 A), Resistance load	
Relay life time	Electrical (more than 50,000 times), Mechanical (more than 10 million times)	
External connection method	8-pin socket	
Insulation resistance	100 M Ω or more (500 V d.c. Mega standard)	
Dielectric strength	2,000 V a.c. 60 Hz 1 minute (Between the conductive part terminal and the case)	
Noise immunity	Square wave noise by noise simulator $\pm 2,000$ V (Pulse width 1 μ s)	
Vibration	<ul style="list-style-type: none"> ● Durability : 10 - 55 Hz (1 minute cycle), Double amplitude 0.75 mm, X · Y · Z 2 hours each direction ● Malfunction : 10 - 55 Hz (1 minute cycle), Double amplitude 0.5 mm, X · Y · Z 10 minutes each direction 	
Ambient temperature & humidity	-10 ~ 55 $^{\circ}$ C, 35 ~ 85 % R.H.	
Storage temperature	-20 ~ 65 $^{\circ}$ C	
Weight (g)	Approx. 92 g	

Suffix code

Model	Code	Content
TF4A-	□-	Digital Timer, 48(W) X 48(H) mm
Time Specifications	A	100 - 240 V a.c. 50/60 Hz

New product
Count/Timer

Small LCD
counter

Digital
Counter/
Timer

New product
Timer

Small LCD
Timer

Digital
Twin Timer

Digital
Timer

Weekly/
yearly
Time switch

Timing
Relay

Analog
ON-Delay
Timer

Analog
Twin/Dual
Timer

Analog
Multi
Timer

Star-delta
Timer

DIGITAL COUNTER/TIMERS

LF4N CE

Specifications



Model		LF4N-A	LF4N-B	LF4N-C	LF4N-D
Appearance					
W×H×D(mm)		48.0×48.0×69.5			
Input	Input signal	Reset, start, inhibit. ✖ LF4N-A and LF4N-D only.			
	Non-voltage input	Paragraph level (during transistor ON): residual voltage max. 0.7 V d.c., impedance max. 2 kΩ			
	Contact input	Open level (during transistor OFF): impedance min. 100 kΩ Use a contact that can open and close 5 V d.c., 2 μA sufficiently			
Performance	Repetition accuracy	● Max. ±0.01 % ±0.05 s of set value (power start), ● Max. ±0.005 % ±0.03 s of set value (start signal)			
	Return time	Max. 0.1 s			
	Noise immunity	Square wave noise by noise simulator (1 μs pulse width), ±2 kV (between operation power terminals)			
	Insulation resistance	Min. 100 MΩ (500 V d.c.) conductive terminal - unfilled metal			
	Dielectric strength	2000 V a.c. 60 Hz for 1 min (different live part terminals)			
Function and output	Output operation mode	Operating mode 10 types (selection by front digital switch) but LF4N-B, LF4N-C (A mode: POWER ON delay fixed)			
	Time display method	Set by internal UP / Down selection switch			
	Time range	Time range 10 types (selection by front digital switch)			
	Set value recognition	Constant recognition (setting can be changed even during energization)			
	Control output	SPDT (1c), 250 V a.c. 3A, resistive load			
		Time limit 1c	Time limit 1c, instantaneous 1c	Time limit 1c × 2	Time limit 1c
Applicable socket	8-Pin socket			11-Pin socket	
Power voltage		24-240 V a.c. 50/60 Hz or 24-240 V d.c. (Universal)			
Voltage fluctuation rate		±10% of power voltage			
Power consumption	240Va.c.	Approx. 2.5 VA	Approx. 2.9 VA		Approx. 2.5 VA
	240Vd.c.	Approx. 1.5 W	Approx. 2.1 W		Approx. 1.5 W
Ambient temperature & humidity		-10 ~ 55 °C, 35 ~ 85 % RH (Without condensation)			
Storage temperature		-20 ~ 65 °C			
Vibration resistance		10 - 55 Hz, Double amplitude 0.75 mm, 3 axes each direction, 2 h			
Shock resistance		300 m/s ² , 3 axes each direction each 3 times			
Weight (g)		80	86		82

Suffix code

Model	Code	Content		
LF4N-	□	LCD Timer		
Types selection	A	Time limit 1c	Operating mode (10 types)	
	B	Time limit 1c, instantaneous 1c	ON delay output (A mode fixed)	
	C	Time limit 2c		
	D	Time limit 1c	Operating mode (10 types)	
Power voltage	24-240 V a.c. 50/60 Hz or 24-240 V d.c. (Common)			

LY series

Specifications

Model		LY4	LY7
Appearance			
W×H×D(mm)		48.0×48.0×59.8	72.0×72.0×56.0
Power voltage		100-240 V a.c. 50/60Hz (Universal)	
Allowable voltage fluctuation rate		±10 % of power voltage	
Power consumption		Approx. 2.6 VA(220 V a.c. 60Hz)	Approx. 4.2 VA (220 V a.c.. 60 Hz)
Display method		LCD Display method (display digits: 4 digits 2 lines) 1st display: character height 7.8 mm, 2nd display: character height 5.2 mm	LLCD Display method (Display digits: 4 digits 2 lines) 1st display: character height 12 mm, 2nd display: character height 7 mm
1 cycle time		● During weekly setting: 1 week (7 Days) ● Yearly setting: for 1 year (Calendar until 2099 built-in)	
Power outage compensation time		More than 5 consecutive years (25°C)	
Setting steps	Number of program steps	Weekly program: 64 steps, yearly program: 32 Steps	
	Number of season settings	4 Seasons (Spring, Summer, Fall, Winter)	
	Number of holiday settings	16 Times	
Installation structure (external connection)		Flush panel mount type, and exposed panel mount type (dual usage) Din rail installation and screw fixing	
Cycle error		±15 Sec/month (25°C)	
Time error		±0.01% max. ±0.05 sec (setting error, voltage error, temperature error)	
Control output	Contact configuration	OUT : SPST (1a)	2 Independent circuits. OUT1 : SPDT (1c), OUT2 : SPDT (1c)
	Contact capacity	15 A 250 V a.c. (Resistive load)	
	Mechanical life	Min. 10 million times	
	Electrical life	Min. 50,000 times (250 V a.c. 15 A resistive load)	
Insulation Resistance		Min. 100 MΩ (500 V d.c. Mega standard, conductive terminal - exposed unfilled metal part)	
Dielectric strength		2000 V a.c. 50/60 Hz for 1 min (Conductive terminal - exposed unfilled metal part)	
Noise immunity		±2 kV(Among operation power terminals), square wave noise by noise simulator (pulse width= 1 μs)	
Vibration resistance		10 - 55 Hz (1 minute cycle) double amplitude 0.75 mm X·Y·Z each direction 1 hour	
Shock resistance		300 m/s² X·Y·Z each direction 3 times	
Ambient temperature & humidity		-10 ~ 55 °C, 35 ~ 85 % RH (without condensation)	
Storage temperature		-20 ~ 65 °C	
Weight (g)		100	275

New product Count/Timer
Small LCD counter
Digital Counter/Timer
New product Timer
Small LCD Timer
Digital Twin Timer
Digital Timer
Weekly/yearly Time switch
Timing Relay
Analog ON-Delay Timer
Analog Twin/Dual Timer
Analog Multi Timer
Star-delta Timer

Suffix code

Model	Code	Content
LY-	<input type="checkbox"/>	LCD Weekly, Yearly Time Switch
Appearance	4	48(W) X 48(H) mm
	7	72(W) X 72(H) mm
Power voltage		100-240 V a.c. 50/60 Hz(Common)

ANALOG TIMERS

T21

Specifications

Model	AC	T21 - 1 / 3 / 6 / 3H - 4A20
	DC	T21 - 1 / 3 / 6 / 3H - 4D24
Appearance		
Power voltage	AC	100-120 V a.c. 50/60 Hz, 200-230 V a.c. 50/60 Hz
	DC	24 V d.c.
Allowable voltage fluctuation rate		±10% of power voltage
Power consumption	AC	Max. 3.1 VA (230 V a.c. 60 Hz)
	DC	Max. 1.5 W (24 V d.c.)
Return time		Max. 100 ms
Time range	1	0.1 sec ~ 10 min
	3	0.3 sec ~ 30 min
	6	0.6 sec ~ 60 min
	3H	0.3 hrs ~ 24 hrs
Time error (Repetition error)		±1 % max. (ratio of maximum scale)
Time error (Setting error)		±10 % max. (ratio of maximum scale)
Control output	Operation mode	Power ON delay, interval, flicker OFF start, flicker ON start
	Contact configuration	4a4b
	Contact capacity	240 V a.c. 3A Resistive load
Relay life		● Mechanical life : min. 10 million times, ● Electrical life : min. 100,000 times
Insulation resistance		Min. 100 MΩ (500 V d.c. standard, conductive terminal - exposed unfilled metal part)
Dielectric strength		2000 V a.c. 50/60 Hz for 1 min (conductive terminal - exposed unfilled metal part)
Noise immunity		±2 kV (among operation power terminals, Pulse width ±1 μs, square wave noise by noise simulator)
Vibration resistance		10 - 55 Hz (For 1 min) double amplitude 0.75 mm X·Y·Z each direction 1 hour
Shock resistance		300 m/s ² X·Y·Z each direction 3 times
Ambient temperature & humidity		- 10 ~ 50 °C, 35 ~ 85 % RH (Without condensation)
Storage temperature		- 25 ~ 65 °C
Weight (g)		42



Suffix code

Model	Code	Content
T21-	<input type="checkbox"/> <input type="checkbox"/> <input type="checkbox"/>	Timing Relay
Time range	1	1 sec, 10 sec, 1 min, 10 min
	3	3 sec, 30 sec, 3 min, 30 min
	6	6 sec, 60 sec, 6 min, 60 min
	3H	3 hrs, 6 hrs, 12 hrs, 24 hrs
Contact configuration	4	4a4b
Power voltage	A20	200-230 V a.c.
	D24	24 V d.c.
	A10	100-120 V a.c.

Selection by side dip switch

T38N, T48N, T57N CE

Specifications

Model	Exposed type	T38N	T48N	T57NE
	Panel type			T57NP
Appearance				
W×H×D (mm)		40.5×50.5×74.0	48.0×48.0×78.7	<ul style="list-style-type: none"> Exposed type : 50.0×70.0×86.2 Panel type : 57.5×84.4×83.7
Functions		Power On Delay Timer		
Power voltage		24-240 V a.c. 50/60 Hz, 24-240 V d.c., 12Vd.c. (Order-made for T48N)		
Voltage fluctuation rate		±10 % of power voltage		
Power consumption		Max. approx. 4.5 VA (240 V a.c. 60 Hz) ● Max. approx. 1.5 W (24 V d.c.)		
Return time		Max. 100 ms		
Time range	01	0.01 ~ 1 s / 0.01 ~ 1 m / 0.01 ~ 1 h		
	03	0.01 ~ 3 s / 0.01 ~ 3 m / 0.01 ~ 3 h		
	06	0.01 ~ 6 s / 0.01 ~ 6 m / 0.01 ~ 6 h		
	10	0.01 ~ 10 s / 0.01 ~ 10 m / 0.01 ~ 10 h		
	30	0.01 ~ 30 s / 0.01 ~ 30 m / 0.01 ~ 30 h		
	60	0.01 ~ 60 s / 0.01 ~ 60 m / 0.01 ~ 60 h		
	12H	0.01 ~ 12 h / 0.01 ~ 24 h / 0.01 ~ 48 h ('24h' and '48h' time setting '12h' : 'x2' and 'x4')		
Time error	Repeating error	Max. ±0.3 % (ratio of maximum scale)		
	Setting error	Max. ±5 % (ratio of maximum scale)		
Control output	Output mode	POWER ON DELAY		
	Contact configuration	A output (time limit 1c + instantaneous 1a) / B output (time limit 1c + instantaneous 1c) / C output (time limit 2c)		
	Contact capacity	250 V a.c. 3 A (Resistive load)		
Relay life		<ul style="list-style-type: none"> Mechanical life : min. 10 million times Electrical life : min. 100,000 times 		
Dielectric strength		2,000 V a.c. 50/60 Hz For 1 min		
Noise immunity		±2 kV (among operation power terminals), square wave noise by noise simulator (pulse width:1 μs)		
Insulation resistance		Min. 100 MΩ (500 V d.c. Mega standard)		
Vibration resistance		10 - 55 Hz (For 1 min) double amplitude 0.5 mm X·Y·Z each direction 2 hours		
Shock resistance		300 m/s ² (30 G) X·Y·Z each direction 3 times		
Ambient temperature & humidity		-10 ~ 55 °C, 30 ~ 85 % RH (Without condensation)		
Storage temperature		-25 ~ 65 °C		
Weight (g)		150		

Suffix code

Model	Code	Content
Appearance	<input type="checkbox"/> - <input type="checkbox"/> <input type="checkbox"/> <input type="checkbox"/> <input type="checkbox"/> <input type="checkbox"/> <input type="checkbox"/>	Analog Timer
	T38N	40(W) X 50(H) mm
	T48N	48(W) X 48(H) mm
	T57N	58(W) X 84(H) mm
Installation structure	P	Panel type (T38N panel adapter sold separately)
	E	Exposed type (select with T48N panel type)
Range (Dip switch selection)	01	1 sec, 1 min, 1 hour
	03	3 sec, 3 min, 3 hour
	06	6 sec, 6 min, 6 hour
	10	10 sec, 10 min, 10 hour
	30	30 sec, 30 min, 30 hour
	60	60 sec, 60 min, 60 hour
	12	12 hour, 24 hour, 48 hour
Control output	A	Time limit: 1c contact, instantaneous: 1a contact
	B	Time limit: 1c contact, instantaneous: 1c contact
	C	Time limit 2c contact
Power voltage		24-240 V a.c. 50/60 Hz or 24-240 V d.c. (Common)
	12	12 V d.c. (Only for T48N, order-made)
Output operation		On-Delay
	S	Interval (Order-made)



※ The installation type is only applied to the T57N, TF62N and TF62D (T38N model requires the separate purchase of panel adapter)

New product Count/Timer
Small LCD counter
Digital Counter/Timer
New product Timer
Small LCD Timer
Digital Twin Timer
Digital Timer
Weekly/yearly Time switch
Timing Relay
Analog ON-Delay Timer
Analog Twin/Dual Timer
Analog Multi Timer
Star-delta Timer

ANALOG TIMERS

TF62N/62D

Specifications

Model	Exposed type	TF62NE	TF62DE
	Panel type	TF62NP	TF62DP
Appearance			
W×H×D (mm)	<ul style="list-style-type: none"> Exposed type : 50.0×62.0×91.2 Panel type : 57.5×84.5×83.7 		<ul style="list-style-type: none"> Exposed type : 50.0×77.0×91.2 Panel type : 57.5×84.4×83.7
Functions	Twin timer		Dual timer
Power voltage	24-240 V a.c. 50/60Hz or 24-240 V d.c. (Common)		
Voltage fluctuation rate	±10 % of power voltage		
Power consumption	<ul style="list-style-type: none"> Max. approx. 4.5 VA (240 V a.c. 60 Hz), Max. approx. 1.5 W (24 V d.c.) 		
Return time	Max. 100 ms		
Time range	01	0.01 ~ 1 s / 0.01 ~ 1 m / 0.01 ~ 1 h	
	03	0.01 ~ 3 s / 0.01 ~ 3 m / 0.01 ~ 3 h	
	06	0.01 ~ 6 s / 0.01 ~ 6 m / 0.01 ~ 6 h	
	10	0.01 ~ 10 s / 0.01 ~ 10 m / 0.01 ~ 10 h	
	30	0.01 ~ 30 s / 0.01 ~ 30 m / 0.01 ~ 30 h	
	60	0.01 ~ 60 s / 0.01 ~ 60 m / 0.01 ~ 60 h	
Time error	Repeating error	Max. ±0.3 % (ratio of maximum scale)	
	Setting error	Max. ±5 % (ratio of maximum scale)	
Control output	Output mode	FLICKER (ON Start)	FLICKER (ON-A Start)
	Contact configuration	D type (time limit 1c)	F type (time limit 2c)
	Contact capacity	250 V a.c. 3 A (Resistive load)	
Relay life	<ul style="list-style-type: none"> Mechanical life: min. 10 million times, Electrical life : min. 100,000 times 		
Dielectric strength	2,000 V a.c. 60 Hz for 1 min		
Noise immunity	±2 kV (among operation power terminals), square wave noise by noise simulator (pulse width:1 μs)		
Insulation resistance	Min. 100 MΩ (500 V d.c. Mega standard)		
Vibration resistance	10 - 55 Hz (for 1 min) single amplitude 0.5 mm X·Y·Z each direction 2 hours		
Shock resistance	300 m/s ² (30 G) X·Y·Z each direction 3 times		
Storage temperature	-25 ~ 65 °C		
Ambient temperature & humidity	-10 ~ 55 °C, 30 ~ 85 % RH (Without condensation)		
Weight (g)	150		

Suffix code

Model	Code	Content
Appearance	<input type="checkbox"/> - <input type="checkbox"/> <input type="checkbox"/> <input type="checkbox"/> <input type="checkbox"/> <input type="checkbox"/>	Analog Timer
	TF62N	Twin timer 58(W) X 84(H) mm
	TF62D	Dual timer 58(W) X 84(H) mm
Installation structure	P	Panel type
	E	Exposed type
Range (Dip switch selection)	01	1 sec, 1 min, 1 hour
	03	3 sec, 3 min, 3 hour
	06	6 sec, 6 min, 6 hour
	10	10 sec, 10 min, 10 hour
	30	30 sec, 30 min, 30 hour
	60	60 sec, 60 min, 60 hour
Control output	D	TF62N Twin timer fixed code
	F	TF62D Dual timer fixed code
Power voltage		24-240 V a.c. 50/60 Hz or 24-240 V d.c. (Common)
	12	12 V d.c. (only for T48N, order-made)

※ Installation type selection is only applied to the model T57N, TF62N and TF62D (Model T38N requires separate purchase of panel adapter)

MA4N series CE

Specifications

Model	MA4N-A	MA4N-B	MA4N-C
Appearance			
W X H X D (mm)	48.0×48.0×61.3		
Power voltage	24-240 V a.c. 50/60Hz or 24-240 V d.c.		
Voltage fluctuation rate	±10 % of power voltage		
Power consumption	5.3 VA (240 V a.c.), 2.5 W (240 V d.c.)		
Return time	Max. 0.1 sec		
Min signal width	START input, INHIBIT input, RESET input: min. 20 ms		-
Input	<ul style="list-style-type: none"> ● Non-voltage input, ● Impedance during short circuit : max. 2 kΩ, ● Residual voltage during short circuit: max. 0.7 V d.c. , ● Impedance during open: min. 100 kΩ 		-
Output	Time limit 2c	Time limit 1c, instantaneous 1c	Time limit 2c, time limit 1c + instantaneous 1c
	<ul style="list-style-type: none"> ● NO : 10 A 125 V a.c., 5 A 250 V a.c., 5 A 30 V d.c. ● NC : 3 A 125 V a.c., 2 A 250 V a.c., 1 A 30 V d.c. 		
Repeating error	Max. ±0.3 %		
Setting error	Max. ±5 %. ±0.05 sec		
Temperature error	Max. ±2 %		
Insulation resistance	Min. 100 MΩ (500 V d.c. mega standard)		
Dielectric strength	2,000 V a.c. 50/60 Hz for 1 min		
Impulse voltage	Max. ±2000 V		
Vibration resistance	10 - 55 Hz Double amplitude 0.75 mm		
Shock resistance	300 m/s ² (approx. 30 G)		
Life	Mechanical	Min. 10 million times (switching frequency 180 times / min)	
	Electrical	More than 100 thousand times (250 V a.c. 3 A resistive load)	
Terminal structure	Plug 11-pin		Plug 8-pin
Ambient temperature & humidity	-10 ~ 55 °C, 35 ~ 85 % RH (단, 결로현상이 없을 것)		
Storage temperature	-20 ~ 65 °C		
Weight (g)	Approx. 100 g (fixtures included)		

New product Count/Timer
Small LCD counter
Digital Counter/Timer
New product Timer
Small LCD Twin Timer
Digital Twin Timer
Digital Timer
Weekly/yearly Time switch
Timing Relay
Analog ON-Delay Timer
Analog Twin/Dual Timer
Analog Multi Timer
Star-delta Timer

Suffix code

Model	Code	Content
MA4N-	<input type="checkbox"/>	Analog Multi Timer
Type	A	Time limit 2c ※ 11-pin type
	B	Time limit 1c + instantaneous 1c ※11-pin type
	C	Time limit 2c, time limit 1c + instantaneous 1c ※ by mode selection (8-pin type)
Power voltage		24-240 V a.c. 50/60 Hz or 24-240 V d.c.

ANALOG TIMERS

MA4SD

Specifications

Model		MA4SD	MA4SDI
Appearance			
W X H X D (mm)		48.0×48.0×61.3	
Power voltage		100-240 V a.c. 50/60Hz, 24-240 V d.c.	
Allowable voltage fluctuation rate		±10 % of power voltage	
Power consumption		Approx. 3.8 VA (100-240 V a.c. 60 Hz), Approx. 1.9 W (24-240 V d.c.)	
Return time		Max. 100 ms	
Operating time range		1 ~ 300 Sec	
λ Operating time error		● Repetition error : max. ±0.3 % ● Setting error : max. ±5 % ● Voltage error : max. ±0.5 % ● Temperature tolerance : max. ±2 % (ratio of maximum scale)	
Δ Conversion time error		Max. ±25 %	
Control output	Operation mode	Power ON Start	
	Contact configuration	λ Contacts : 1a, Δ Contacts : 1a	λ Contacts : 1a, Δ contacts: 1a, instantaneous contacts: 1a
	Contact capacity	250 V a.c. 5 A resistive load	
Relay life		● Mechanical: min. 5 million times ● Electrical: min. 100,000 times (250 V a.c. 5 A resistive load)	
Insulation resistance		Min. 100 MΩ (500 V d.c. Mega standard, conductive terminal - exposed unfilled metal part)	
Dielectric strength		2000 V a.c. 50/60 Hz for 2 min (conductive terminal - exposed unfilled metal part)	
Noise immunity		±2 kV (among operation power terminals, pulse width ±1 μs, square wave noise by noise simulator)	
Vibration resistance		10 - 55 Hz (for 1 min), double amplitude 0.75 mm X·Y·Z each direction 1 hour	
Shock resistance		300 m/s ² (30G) X·Y·Z each direction 3 times	
Ambient temperature & humidity		-10 ~ 55 °C, 35 ~ 85 % RH (Without condensation)	
Storage temperature		-25 ~ 65 °C	
Weight (g)		Approx. 95 g (fixtures included)	



Suffix code

Model	Code	Content
MA4	□	Analog Multi Timer (Star-Delta Timer), 48 (W) × 48 (H) mm
Control output	SD	λ (Star) output, Δ (Delta) output
	SDI	Instantaneous output, λ (Star) output, Δ (Delta) output

LP3



Specifications

Model		LP3-5A5	LP3-5A3	LP3-5AN
Appearance				
WXHxD(mm)		96.0×48.0×71.1		
Power voltage		100-240 V a.c. 50/60 Hz		
Power consumption		Max. 15 VA	Max. 13 VA	Max. 10 VA
Display method		Negative LCD display		
Character size		PV value (14.5 mm), SV value (10 mm)		
Input frequency		Contactless (max. 50 KHz, ON/OFF pulse width 10 us min), contact (max. 30 Hz, ON/OFF pulse width min. 16.6 ms)		
Input type	Voltage	[H] level (4.5 - 24 V d.c.), [L] level (0 - 1 V d.c.), input impedance (4.5 kΩ)		
	Non-voltage	Impedance during short circuit (max. 300 Ω), residual voltage (1 V max), impedance during open (min. 100 kΩ)		
Measuring range		F1, F2, F10, F11, F12, F13 : 0.0005 ~ 50 KHz, F3, F4, F5, F6 : 0.001 s ~ 3200 s, F7, F8, F9 : 0 ~ 4x10 ⁹		
Measuring accuracy		F1, F4, F10, F11, F12, F13 : FS ±0.05 % rdg ±1 digit, F2, F3, F5, F6 : FS ±0.01 % rdg ±1 digit		
External power supply		12 V d.c. ±10 % 100 mA		
Display cycle		0.05 sec / 0.5 sec / 1 sec / 2 sec / 4 sec / 8 sec		
Display range		-99999 ~ 99999		
Power outage compensation		Approx. 10 years (applying non-volatile EEPROM)		
Control output		HH (SPST), H (SPST), GO (SPST), L (SPST), LL (SPST) * HH/H output COM common, * LL/L output COM common	H (SPDT), GO (SPST), L (SPDT)	-
		NO contact (250 V a.c. 5 A resistive load), NC contact (250 V a.c. 2 A resistive load)		
Relay Life	Electrical	Min. 100 thousand times		
	Mechanical	Min. 10 million times (250 V a.c. 2A)		
Vibration resistance		10 - 55 Hz double amplitude 0.75 mm X·Y·Z each direction 2 hours		
Insulation Resistance		Min. 100 MΩ (500 V d.c.), conductive terminal - unfilled metal		
Dielectric strength		2000 V a.c. at 60Hz for 1 min (different live part terminals)		
Noise immunity		±2000 V (pulse width 1 μs, apply square wave noise by noise simulator among power terminals)		
Degree of protection		IP66 (IEC 60529) (product front)		
Ambient temperature & humidity		-10 ~ 50 °C, 35 ~ 85 % RH (Without condensation)		
Storage temperature		-20 ~ 60 °C		
Certified				
Weight (g) ※		210	208	154

※ The weight includes the terminal cover and the cover weight is 8g.

New product
Multi-pulse
meter

Small LCD
Pulse meter

Multi
Pulse meter

New product
Multi Panel
meter

Digital
Multi Panel
meter

Digital
Wattmeter

Digital
Voltage/
Ammeter

Digital
Frequency
meter

Digital
Scale meter

Digital
Small type
DC indicator

Suffix code

Model	Code	Content
LP	<input type="checkbox"/> <input type="checkbox"/> <input type="checkbox"/> <input type="checkbox"/>	LCD Multi Pulse Meter
Appearance	3	96(W) × 48(H) mm
Display digits	5	5-Digit display
Power voltage	A	100-240 V a.c. 50/60 Hz
Output specifications	N	Indication only
	3	3-stage setting (H/GO/L)
	5	5-stage setting (HH/H/GO/L/LL)

PANEL METERS

LP1

Specifications

Model		LP1
Appearance		
WXHxD(mm)		48.0×24.0×54.0
Power voltage		Non-power (battery built-in, changeable)
Display method		LCD display method, zero blanking
Battery life		More than approx. 3 years (approx. 25 °C)
Character size		8.7 mm
Input type	Voltage input (INB)	● AC voltage input: 3 - 30 V a.c. ● DC voltage input: When High 4.5 - 30 V d.c. When Low 0 - 2 V d.c.
	Voltage input (INC)	30-240 V a.c.
	Non-voltage input (INA)	● Residual voltage during short circuit: max. 0.5 V, ● Max. impedance during short circuit: max. 10 kΩ, ● Min impedance during open: min. 500 kΩ
HOLD input method		Non-voltage input
Measuring range		● rpm (1 ~ 10000 rpm), ● 0.1 rpm (0.1 ~ 1000.0 rpm), ● rps (1 ~ 1000 rps), ● Hz (1 ~ 1000 Hz), ● 0.1 Hz (0.1 ~ 100.0 Hz)
External setting switch		SW1-1 : rps / rpm, SW1-2 : ×1 / ×0.1, SW2-1 : RESET, SW2-2 : (rps, rpm) / Hz
External connection		Terminal block (5 pins)
Measuring accuracy		±0.1% rdg ±1 digit
Vibration resistance		10 - 55 Hz (1 minute cycle) double amplitude 0.75 mm X·Y·Z each direction 1 hour
Shock resistance		300 m/s² X·Y·Z each direction 3 times
Insulation Resistance		Min. 100 MΩ (500 V d.c. Mega standard, conductive terminal - exposed unfilled metal part)
Dielectric strength		2000 V a.c. 50/60 Hz for 1 min (conductive terminal - exposed unfilled metal part)
Ambient temperature & humidity		-10 ~ 55 °C, 35 ~ 85 % RH (Without condensation)
Storage temperature		-20 ~ 65 °C
Weight (g)		46

(note 1) The battery life is calculated based on the above conditions, so please consider them while replacing it

HLP1

Specifications

Model		HLP1
Appearance		
W X H X D (mm)		48.0×24.0×37.1
Input	Input specifications	4-20 mA d.c.
	Max. display digits	4 Digits (-1999 ~ 9999)
	Sampling cycle	Selection by parameter (0.5, 1, 2, 3, 4, 5 sec)
	Input correction	±3 % of FS
Performance	Accuracy	±0.3 % of FS ±1 Digit
	Insulation resistance	100 MΩ (500 V d.c.)
	Dielectric strength	2,300V a.c. 50/60 Hz for 1 min
Functions		● High limit scale setting ● Low limit scale setting ● Decimal point setting ● Display cycle setting ● Error display range setting ● High limit correction of display value ● Low limit correction of display value ● Measurement delay time setting ● Flashing function setting ● Parameter lock setting
Power voltage		Non-voltage type
Ambient temperature & humidity		-5 ~ 50 °C, 20 ~ 90 % RH (Without condensation)
Storage temperature		-25 ~ 70 °C
Vibration resistance		10 ~ 55 Hz single amplitude X·Y·Z each direction 2 hours
Shock resistance		300 m/s², X·Y·Z each direction 3 times

LM series

NEW

Specifications

Model	LM3/6-DV	LM3/6-DA	LM3/6-AV	LM3/6-AA
				
Size	<ul style="list-style-type: none"> LM3 : 96(W) X 48(H) X 68(D) mm LM6 : 72(W) X 36(H) X 81(D) mm 			
Power	100 - 240 V a.c. 50/60 Hz			
Power Consumption	<ul style="list-style-type: none"> LM3-N: 6 VA or less LM6-N: 5 VA or less LM3-3R/3RC: 10 VA or less LM6-3R: 7 VA or less LM3-3RT: 11 VA or less LM3-3N/3P: 5 VA or less LM3-3NC/3PC: 9 VA or less LM3-RC: 6 VA or less LM3-3NT/3PT: 10 VA or less LM3-RT: 7 VA or less 			
Input signal	DC voltage		DC current	
Input range	500 V / 100 V 50 V / 10 V 5 V / 1 V 200 mV / 50 mV		5 A / 2 A 500 mA / 200 mA 50 mA / 4 - 20 mA 5 mA / 2 mA	
			AC voltage / frequency	
			AC current / frequency	
AC measurement method	AVG / RMS selective measurement			
Input sampling cycle	50 ms			
Input sampling method	OVER sampling method using continuous approximation A / D converter			
Maximum allowable input	F.S. of each input range 110 %			
Frequency measurement range	0.2 ~ 9999 Hz (Frequency measurement range depends on the decimal point position)			
Display	<ul style="list-style-type: none"> Negative-LCD 4 digit 2 rows PV (White) SV (Green) 			
Character size	<ul style="list-style-type: none"> LM3 : 17.6 X 10.6 mm LM6 : 7.0 X 11.5 mm 			
Maximum display	- 9999 ~ 9999			
Display degree	<ul style="list-style-type: none"> [23 °C ± 5 °C] · F.S. ± 0.1 % rdg ± 2 digit [23 °C ± 5 °C, 5 A] · F.S. ± 0.3 % rdg ± 3 digit [50 °C ~ 10 °C] · F.S. ± 0.5 % rdg ± 3 digit 		<ul style="list-style-type: none"> [23 °C ± 5 °C] · F.S. ± 0.3 % rdg ± 3 digit [23 °C ± 5 °C, frequency] · F.S. ± 0.1 % rdg ± 2 digit [50 °C ~ 10 °C] · F.S. ± 0.5 % rdg ± 3 digit 	
Control output	<ul style="list-style-type: none"> Contact output : 3 stage, SPST (1a), 250 V a.c. 5 A 3 stage, Solid state output: 3-stage, NPN or PNP open collector, 12 - 24 V d.c. 50mA or less 			
Relay life time	<ul style="list-style-type: none"> Electrical (about 100,000 times, 250 V a.c. 5 A) Mechanical (about 5 million times) 			
Optional output	<ul style="list-style-type: none"> Transmission output (4-20 mA) RS-485 output 			
External input	<ul style="list-style-type: none"> HOLD/ZERO Optional input Non-voltage input Short circuit impedance: 300 Ω or less Residual voltage: 1 V or less Impedance when open: 100 kΩ or more 			
Communication	<ul style="list-style-type: none"> Communication protocol : Modbus-RTU Communication method : RS-485 (2-wire half duplex) Communication speed : 2400 / 4800 / 9600 / 19200 / 38400 bps 			
Insulation Resistance	100 MΩ or more (500 V d.c. Mega standard, between conductive terminal and case)			
Withstand voltage	2000 V a.c. 60 Hz 1 minute (between conductive terminal and case)			
Noise	± 2 kV(Between operation power terminals, Pulse width = 1 us, Square wave noise by noise simulator)			
Vibration resistance	10 · 55 Hz, Single amplitude 0.5 mm, 3-axis angular, 2 hours			
Protection structure	IP66 (front) Terminal block protection cover applied			
Ambient temperature and humidity	- 10 ~ 50 °C, 35 ~ 85 % RH			
Storage temperature	- 20 ~ 65 °C			

Suffix code

Model	Code	Description
LM	<input type="checkbox"/> - <input type="checkbox"/> <input type="checkbox"/> - <input type="checkbox"/> <input type="checkbox"/> <input type="checkbox"/> <input type="checkbox"/>	LCD Multi Panelmeter
Appearance	3	96(W) X 48(H) mm
	6	72(W) X 36(H) mm
Displayable Digit	4	4 Digit indication
Input Specification	DV	DC voltage
	DA	DC current
	AV	AC voltage
	AA	Alternating current
Output specifications	N	Non only (Indication option output)
	R	1-stage contact output *LM6 only (For LM6-RC/RT, 1-stage contact output fixed.)
	3R	3 - stage contact output
	3N	3 - stage NPN open collector output
	3P	3 - stage PNP open collector output
Optional output	-	Non option output
	C	RS - 485 output (MODBUS - RTU)
	T	Transmission output (4 - 20 mA d.c.)
Power supply voltage	A	100 - 240 V a.c. 50/60 Hz

New product
Multi-pulse
meter

Small LCD
Pulse meter

Multi
Pulse meter

New product
Multi Panel
meter

Digital
Multi Panel
meter

Digital
Wattmeter

Digital
Voltage/
Ammeter

Digital
Frequency
meter

Digital
Scale meter

Digital
Small type
DC indicator

PANEL METERS

WM3 CE

Specifications

Model	WM3
Appearance	
WXHxD(mm)	96.0×48.0×102.0
Method of measurement	Periodic measurement method
Input Voltage	0 - 220 V a.c.
Display Cycle	0.1 ~ 2 sec
Power factor	80 ~ 100 %
Response speed	2 seconds (maximum range)
Number of displayed lines	4 Digit (-1999 ~ 9999)
Display	7 Segment LED
Accuracy	±0.5 % of FS, ±10 Digit
Insulation Resistance	100 MΩ or more (500 V d.c.)
Voltage Resistance	2,000 V a.c. 1 minute (power terminal - input terminal)
Function	<ul style="list-style-type: none"> ● Measurement item, ● Show Average Value, ● Scale Functions, ● Set Decimal Point, ● Hold, ● Show Maximum/Minimum, ● Communication Functions, ● Effective Value (RMS) measurement function, ● Decimal Point Location, ● Hold function, ● Lock function, ● Address, ● Communication speed, ● Show Maximum Value, ● Show Min Value, ● Upper limit setting, ● Lower limit setting, ● Select Output Behavior (PSOT), ● Hysteresis Settings,
Communication Output (RS485)	You can set the address from 00 to 99 times and select the modulation rate for serial transmissions (transmission rate: 1200, 2400, 4800, 9600, 19200 bps)
Current Output (Transfer)	4-20 mA d.c. output for the current indicator (resolution: 12,000)
Transistor Output	PNP/NPN Open Collector Output (12-24V d.c. 50mA or less)
Relay Output	1 a X 3 Contact (HI, GO, LO), (220 V a.c. 5 A)
Power Voltage	100-240 V a.c. 50/60 Hz (Common)
Voltage Fluctuation Rate	-15 to 10% of the power voltage
Power Consumed	Approx. 5 VA
Ambient temperature & humidity	0 ~ 50 °C, 35 ~ 85 % RH (No condensation)
Storage temperature	-10 ~ 70 °C
Vibration resistance	10-55 Hz single amplitude for 2 hours in each of X, Y, and Z directions
Shock resistance	300 m/s ² X·Y·Z 6 each direction 3 times
Weight (g)	300

Suffix code



Model	Code	Content
WM3-	<input type="checkbox"/> <input type="checkbox"/> <input type="checkbox"/>	Digital power meter
Constants and Wires	1	Single-phase 2-ray (0-220 V a.c.)
Input Specifications	01	Input Specification Reference (see code)
Output (optional)	N	Display Only
	0	Relay (HI, GO, LO), 4-20mA d.c.
	1	Relay (HI, GO, LO)
	2	NPN open Collector (HI, GO, LO), 4-20 mA d.c.
	3	PNP open Collector (HI, GO, LO), 4-20 mA d.c.
	4	NPN open Collector (HI, GO, LO), RS485
	5	PNP open Collector (HI, GO, LO), RS485

Input Specifications

Code	Content		
01	XXX : 5 A	Universal Translator	Set Transmission Ratio (CT sold separately)
02	XXX : 1 A		Set Transmission Ratio (CT sold separately)
03	0 - 2.5 A	Dedicated Translator (H-1W)	0 - 500.0 W max. (With CT)
04	0 - 5 A		0 - 1100.0 W max. (With CT)
05	0 - 10 A		0 - 2200.0 W max. (With CT)
06	0 - 15 A		0 - 3300.0 W max. (With CT)
07	0 - 30 A	Dedicated Translator (H-2W)	0 - 6600.0 W max. (With CT)
08	0 - 50 A		0 - 11.00 KW max. (With CT)
09	0 - 80 A	Dedicated Translator (H-4W)	0 - 17.60 KW max. (With CT)
10	0 - 100 A		0 - 22.00 KW max. (With CT)
11	0 - 150 A	Dedicated Translator (H-5W)	0 - 33.00 KW max. (With CT)
12	0 - 200 A		0 - 44.00 KW max. (With CT)

BS series

Specifications

Model		BS3	BS6	BS1
Appearance				
WXHxD(mm)		96.0×48×102.0	72.0×36.0×100.0	48.0×24.0×100.0
Input	Input signal	Input voltage, current, instrument signal input (4 - 20 mA d.c. or 1 - 5 V d.c.)		
	A/D converter	Double integration method		
	Sampling cycle	300 ms		400 ms
	Response speed	Approx. 2 sec (max. range)		Approx. 3 sec (max. range)
	External control	Present value hold function by contact input		
	Max. display digits	± 1999		
	Display	7 segment LED		
Performance	Measurement and indication method	Effective value indicating method by full-wave rectification		
	Accuracy	AC : ±0.5 % of FS ±1 Digit, DC : ±0.2 % of FS ±1 Digit		
	Insulation resistance	Min. 100 MΩ (500 V d.c.)		
	Dielectric strength	1500 V a.c. for 1 min (between external terminal and case)	2000 V a.c. for 1 min (between external terminal and case)	
Power voltage		110 V / 220 V a.c. 50/60 Hz common		100-240 V a.c. 50/60 Hz common
Voltage fluctuation rate		±10 % of power voltage		-15 ~ 10 % of power voltage
Power consumption		Max. 2 VA		Max. 4 VA
Ambient temperature & humidity		0 ~ 50 °C, 35 ~ 85 % RH (without condensation)		-10 ~ 55 °C, 35 ~ 85 % RH (without condensation)
Storage temperature		-10 ~ 70 °C		-20 ~ 65 °C
Vibration resistance		10 - 55 Hz single amplitude X·Y·Z each direction 2 hours		
Shock resistance		300 m/s ² , X·Y·Z 6 directions each 3 times		
Weight (g)		350	250	150

New product
Multi-pulse
meter

Small LCD
Pulse meter

Multi
Pulse meter

New product
Multi Panel
meter

Digital
Multi Panel
meter

Digital
Wattmeter

Digital
Voltage/
Ammeter

Digital
Frequency
meter

Digital
Scale meter

Digital
Small type
DC indicator

Suffix code ※ Model name : BS6 and BS3 have different range codes

Model	Code	Content	
BS	<input type="checkbox"/> - <input type="checkbox"/> <input type="checkbox"/> <input type="checkbox"/> <input type="checkbox"/> <input type="checkbox"/>	Digital Voltmeter / Ammeter	
Appearance	6	72 X 36 mm	
	3	96 X 48 mm	
	1	48 X 24 mm	
Output	N	Display only	
Input	A	10	AC voltmeter (AC)
		20	AC ammeter (AC)
	D	10	DC voltmeter (DC)
		20	DC ammeter (DC)
		11	DC voltmeter
		21	DC ammeter
Measuring range	1	Measuring range model example: BS3-NA101 (1.999 V)	

● DC current (BS1)

Model	Measuring range	Resolution	Input impedance	Max. allowable input current
BS1-ND201	199.9 μA	0.1 μA	1 kΩ	50 mA
BS1-ND202	1.999 mA	1 μA	100 Ω	150 mA
BS1-ND203	19.99 mA	10 μA	10 Ω	300 mA
BS1-ND204	199.9 mA	100 μA	1 Ω	3 A
BS1-ND205	1.999 A	1 mA	0.1 Ω	3 A
BS1-ND206	5.00 A	10 mA	0.01 Ω	5 A
BS1-ND207	19.99 A	10 mA	Shunt use (secondary voltage 50mV)	
BS1-ND208	199.9 A	100 mA		
BS1-ND209	1999 A	1 A		

● DC current (BS3)

Model	Measuring range	Resolution	Input impedance	Max. allowable input current
BS3-ND201	1.999 mA	1 μA	100 Ω	50 mA
BS3-ND202	19.99 mA	10 μA	10 Ω	150 mA
BS3-ND203	199.9 mA	100 μA	1 Ω	300 mA
BS3-ND204	1.999 A	1 mA	0.1 Ω	3 A
BS3-ND205	5.00 A	10 mA	0.01 Ω	5 A
BS3-ND206	19.99 A	10 mA	Shunt use (secondary voltage 50mV)	
BS3-ND207	199.9 A	100 mA		
BS3-ND208	1999 A	1 A		

● DC current (BS6)

Model	Measuring range	Resolution	Input impedance	Max. allowable input current
BS6-ND201	199.9 μA	0.1 μA	100 Ω	1 mA
BS6-ND202	1.999 mA	1 μA	10 Ω	50 mA
BS6-ND203	19.99 mA	10 μA	1 Ω	150 mA
BS6-ND204	199.9 mA	100 μA	0.1 Ω	300 mA
BS6-ND205	5.00 A	10 mA	400 MΩ	5.1 A
BS6-ND206	19.99 A	10 mA	Shunt use (secondary voltage 50mV)	
BS6-ND207	199.9 A	100 mA		
BS6-ND208	1999 A	1 A		

Measuring range ● AC current (BS3, BS6, BS1)

Model	Measuring range	Resolution	Input impedance	Max. allowable input current
BS□-NA201	19.99 mA	10 μA	10 Ω	50 mA
BS□-NA202	199.9 mA	100 μA	1 Ω	300 mA
BS□-NA203	1.999 A	1 mA	0.1 Ω	3 A
BS□-NA204	5.00 A	10 mA	40 MΩ	5.1 A
BS□-NA205	19.99 A	10 mA	Current transformer use (secondary current 5A)	
BS□-NA206	30.0 A	100 mA		
BS□-NA207	100.0 A	100 mA		
BS□-NA208	150.0 A	100 mA		
BS□-NA209	199.9 A	100 mA		
BS□-NA210	300 A	1 A		
BS□-NA211	1999 A	1 A		

● AC voltage (BS3)

Model	Measuring range	Resolution	Input impedance	Max. allowable input current
BS3-NA101	1.999 V	1 mV	100 kΩ	10 V
BS3-NA102	19.99 V	10 mV	1 MΩ	50 V
BS3-NA103	199.9 V	100 mV	10 MΩ	300 V
BS3-NA104	400 V	1 V	10 MΩ	500 V
BS6-NA105	400 V	1 V	10 MΩ	500 V

● AC voltage (BS6, BS1)

※ Model name: BS1-NA105 (range: 500V)

Model	Measuring range	Resolution	Input impedance	Max. allowable input current
BS □-NA101	199.9 mV	0.1 mV	10 kΩ	10 V
BS □-NA102	1.999 V	1 mV	100 kΩ	10 V
BS □-NA103	19.99 V	10 mV	1 MΩ	50 V
BS □-NA104	199.9 V	100 mV	10 MΩ	300 V
BS6-NA105	400 V	1 V	10 MΩ	500 V
BS1-NA105	500 V	1 V	10 MΩ	500 V

● DC ammeter (BS3, BS6, BS1)

Model	Input	Display range	Input impedance	Max. allowable input current
BS □-ND211	4-20 mA DC	50.0	25 Ω	150 mA
BS □-ND212		100.0	50 Ω	150 mA
BS □-ND213		199.9	100 Ω	150 mA

● DC voltmeter (BS3, BS6, BS1)

Model	Input	Display range	Input impedance	Max. allowable input current
BS □-ND111	1-5Vd.c.	50.0	500 kΩ	100 V
BS □-ND112		100.0	500 kΩ	100 V
BS □-ND113		199.9	500 kΩ	100 V
Input Measuring range 0 - 10 V d.c. (optional)				

● DC voltage (BS3, BS6, BS1)

Model	Measuring range	Resolution	Input impedance	Max. allowable input voltage
BS□-ND101	199.9 mV	0.1 mV	10 kΩ	70 V
BS□-ND102	1.999 V	1 mV	100 kΩ	100 V
BS□-ND103	19.99 V	10 mV	1 MΩ	200 V
BS□-ND104	199.9 V	100 mV	10 MΩ	300 V
BS□-ND105	500 V	1 V	10 MΩ	600 V

PANEL METERS

HP3

Specifications

Model		HP3
Appearance		
WXHxD(mm)		96.0×48.0×100.0
Input	Input contact	1 Channel
	Input signal	4 - 20 mA / 1-5 V d.c. (2-wire current output and 3-wire voltage output type transducer only)
	Max. display digits	5 Digits (±19999)
	Sampling cycle	500 ms
	Input correction	-100 ~ 100 % of FS
	Input filter setting	0 ~ 100 sec
Performance	Degree of Display	±0.03 % of FS
	Retransmission output	4-20 mA d.c. (Load resistance: max. 600 Ω)
	Insulation resistance	100 MΩ (500 V d.c.)
	Dielectric strength	2,300 V a.c. 50/60 Hz for 1 min
Functions	Alarm setting	2 Contacts (AL1, AL2)
	Alarm Hysteresis setting	AL1, AL2 each setting (0 ~ 10 % of FS)
	Communication function	Select between RS232 or RS485
	Retransmission type	Select retransmission output by parameter (DIR, REV, SQRT)
	Scale setting	-19999 ~ 19999
	Decimal places setting	0 ~ 4
	Filter setting	0 ~ 100 sec
	Present value correction	-100 ~ 100 % of FS
	Sensor disconnection selection	Selection by parameter UP(0)/DOWN (1)/OFF(2)
LOCK Functions	Data setting lock function selection OFF (0) / ON (1)	
Output	Alarm output	Output points: 1c X 2 contacts (AL1, AL2)
		Contact capacity: 5 A 240 V a.c. (5 A 30 V d.c.)
		Resolution : 125 ms
	Retransmission output	Hysteresis : 0~10 % of FS
		Retransmission type : Selection by parameter (DIR, REV, SQRT)
		Output points : 1 contact
Normal specifications	Power voltage	100-240 V a.c. 50/60 Hz
	Voltage fluctuation rate	±10 % of power voltage
	Power consumption	Approx. 5 VA
	Ambient temperature & humidity	-5 ~ 50 °C, 20 ~ 90 % RH (Without condensation)
	Storage temperature	-25 ~ 70 °C
	Vibration resistance	10 - 55 Hz single amplitude X·Y·Z each direction 2 hours
	Shock resistance	300 m/s ² , X·Y·Z directions each 3 times
	Weight (g)	300

Suffix code

Model	Code	Content
HP3-	<input type="checkbox"/>	Digital Scale Meter
Option	0	No communication
	1	RS232
	2	RS485

BA1

Specifications

Model		BA1-D□□	BA1-D□□A
Appearance			
WXHxD(mm)		48.0×24.0×60.0	
Input	Input signal	Input voltage, current, instrument signal input (4 - 20 mA d.c. or 1 - 5 V d.c.)	
	A / D converter	Double integration method	
	Sampling cycle	300 ms	
	Response speed	Approx. 2 sec (max. range)	
	Max. display digits	±1999	
Performance	Accuracy	DC : ±0.2 % FS ±1 Digit	
	Insulation resistance	Min. 100 MΩ (500 V d.c.)	
	Dielectric strength	1500 V a.c. for 1 min (between power terminals and input terminals)	
Functions	Decimal point display	10 ¹ , 10 ² , 10 ³ display by rear terminal connection	
	Polarity display	If the input signal is reversed, "-" is displayed automatically	
	Range over display	Displayed as "1 □□□"	
	Range below display	Displayed as "-1□□□"	
	Display	7 segment LED	
Power voltage		5 V d.c.	12-24 V d.c.
Voltage fluctuation rate		±10 % of power voltage	
Power consumption		Approx. 3 W	Approx. 5 W
Ambient temperature & humidity		0 ~ 50 °C, 35 ~ 85 % RH (without condensation)	
Storage temperature		-10 ~ 70 °C	
Vibration resistance		10 ~ 55 Hz 편진폭 X·Y·Z each direction 2 hours	
Shock resistance		300 m/s ² , X·Y·Z each direction 3 times	

New product
Multi-pulse
meter

Small LCD
Pulse meter

Multi
Pulse meter

New product
Multi Panel
meter

Digital
Multi Panel
meter

Digital
Wattmeter

Digital
Voltage/
Ammeter

Digital
Frequency
meter

Digital
Scale meter

Digital
Small type
DC indicator

Suffix code

Model	Code	Content
BA1-	□ □ □ □	Digital Voltmeter / Ammeter
Input	D 10	DC voltage (DC)
	D 20	DC current (DC)
	D 11	DC voltmeter (1-5 V d.c.)
	D 21	DC ammeter (4-20 mA d.c.)
Range code		Refer to measuring range
Power voltage		5 V d.c.
		A 12-24 V d.c.

Measuring range

● DC voltage

Model	Measuring range	Resolution	Input impedance	Max. allowable input voltage
BA1-D101	199.9 mV	100 μV	100 kΩ	70 V
BA1-D102	1.999 V	1 mV	1 MΩ	100 V
BA1-D103	19.99 V	10 mV	1 MΩ	250 V
BA1-D104	199.9 V	100 mV	10 MΩ	300 V
BA1-D111	1-5Vd.c.	50.0	100 kΩ	100 V
BA1-D112		100.0	100 kΩ	100 V
BA1-D113		199.9	100 kΩ	100 V

● DC current

Model	Measuring range	Resolution	Input impedance	Max. allowable input voltage
BA1-D201	199.9 μA	0.1 μA	1 kΩ	1 mA
BA1-D202	1.999 mA	1 μA	100 Ω	50 mA
BA1-D203	19.99 mA	10 μA	10 Ω	150 mA
BA1-D204	199.9 mA	100 μA	1 Ω	300 mA
BA1-D205	1.999 A	1 mA	Shunt use (Secondary voltage 50 mV)	
BA1-D206	19.99 A	10 mA		
BA1-D207	199.9 A	100 mA		
BA1-D208	1999 A	1 A		
BA1-D211	4-20mA d.c.	50.0	25 Ω	150 mA
BA1-D212		100.0	50 Ω	150 mA
BA1-D213		199.9	100 Ω	150 mA

※ Accuracy: ± 0.2% of present value ± 1 digit (23 °C ± 5 °C)

※ Accuracy: ± 0.2% of present value ± 1 digit (23 °C ± 5 °C)

EM310

Specifications

Model	EM310
Appearance	
Power voltage	24 V d.c. 500 mA
Communication method	Asynchronous serial communication (RS232C)
Communication speed	38,400 bps
Communication distance	Max. 5 m
Setting method	Front switch operation method
Storage medium	USB memory stick
File system	FAT16, 32 support
Internal memory	32 Mbyte (Non-volatile)
Applicable products	TH500, TH300, TD500, TS500 (However, TD500 and TH300 only support RS232 products)

CV250

Specifications



Model	CV250
Appearance	
Power voltage	100 / 240 V a.c. 50/60 Hz
Power consumption	Approx. 3 VA
Input signal	RTD : Pt100 Ω (IEC751), DRY / WET each 1 year
Measuring range	Temperature : 0 ~ 100 °C, Humidity : 0 ~ 100 % RH
Accuracy	Temperature : ±0.5 %, Humidity : ±1 % RH
Output signal	Individual temperature/humidity output (Current by suffix code / output selection), 4 - 20 mA d.c. (load resistance max. 600 Ω), 1 - 5 V d.c (load resistance 1 kΩ min)
Output compensation	±5 % (Offset correction by variable resistor)
Insulation resistance	Min. 20 MΩ (500 V d.c.)
Dielectric strength	2500 V a.c. (power terminal-signal input/output terminal)
Ambient temperature & humidity	0 ~ 50 °C, 35 ~ 85 % RH (without condensation)
Storage temperature	-25 ~ 65 °C
Weight (g)	300

Suffix code

Model	Code	Content
CV250-	□	Temperature / Humidity Converter
Output signal	C	4-20 mA d.c.
	V	1-5 V d.c.



CV310/300

Specifications

Model	CV310	CV300
Appearance		
W×H×D(mm)	49.3×33.0×17.8	52.0 x 90.0 x 20.0
Power voltage	9-30 V d.c.	9 V, 300 mA d.c. Adapter (1.3 Ø DC Jack)
Max. communication speed	460800 bps	2400 ~ 115200 bps
Communication distance	Max. 1.2 km, 256 node connectable	Max. 1.5 km, 256 node connectable
Safety	Built-in 2kV protection device for RS232 and RS485 / RS422	1/2nd circuit insulation, Surge Protection Device Built-in, Automatically generate ±15 KV ESD Protection Line Drive signals
Function setting	2-wire / 4-wire, built-in terminal resistor use/ not use, full / half-duplex	Two-line/four-line, built-in termination resistance can be set, such as oil, zero, full/half duplex, etc.
Setting switch	4 Pin Dip Switch	6 Pin Piano Type Dip-Switch
Weight (g)	24	Body : 60, Adapter : 300

HMCE-103

Specifications

Model	HMCE-103
Appearance	
CPU	PIC32MX695F512L
Memory	SRAM : 128 Kbit, Flash : 512 Kbit
Input voltage	5 V d.c. (±10 %)
Max. Current	Max. under 250 mA
RS232 communication	<ul style="list-style-type: none"> ● Data communication / serial console male DB9 serial port, ● Communication speed : 2400 ~ 115200 bps, ● Flow control : None, ● Signal : TX, RX, GND 신호 : TX, RX, GND
RS485 communication	<ul style="list-style-type: none"> ● 2-wire half-duplex method for data communication, ● Communication speed : 2400 ~ 115200 bps, ● Flow control: DE/RE, ● Signal : TX+, TX-
RS-422 communication	<ul style="list-style-type: none"> ● 4-wire full-duplex method for data communication, ● Communication speed : 2400 ~ 115200 bps, ● Flow control: None, ● Signal : TX+, RX+, TX-, RX-
Ethernet communication	<ul style="list-style-type: none"> ● 10/100 Base-T Ethernet (RJ-45 Connector), ● Fluid IP support, ● It is possible to access many clients (up to 3), ● ARP, IP/ICMP, TCP, Telnet, DHCP
Ambient setting	Telnet or serial console interface
LED	● Power input display, ● Activation status display
Ambient temperature	-10 ~ 60 °C
Storage temperature	-30 ~ 80 °C
Certification standard	 KCC-REM-NUX-HMCE-103
Warranty period	1 Year
Weight (g)	74

Floatless level switches / Electrode holder

FS-3A

Specifications

Model	FS-3 A(High sensitivity)	FS-3 A(Low sensitivity)
Appearance		
Power voltage	110 V a.c. 50/60 Hz / 220 V a.c. 50/60 Hz	
Allowable voltage fluctuation range	±10 % of power voltage	
Inter-electrode voltage (secondary voltage)	24 V a.c.	8 V a.c.
Power consumption	Approx. 3.2 VA	
Response time	80 ms max. for operation, 160 ms max. for return	
Inter-electrode operation resistance	0 - Approx. 27 KΩ	0 - Approx. 7 KΩ
Inter-electrode return resistance	Approx. 38 KΩ - ∞ Ω	Approx. 15 KΩ - ∞ Ω
Control output	Relay contact outputs: (1c): 250 V a.c. 5 A (resistive load)	
Insulation resistance	Min. 100 MΩ (500 V d.c. Mega), conductive and exposed unfilled metal part	
Dielectric strength	2000 V a.c. 50/60 Hz for 1 min (1st terminal - 2nd terminal)	
Vibration resistance	10 - 55 Hz (1 minute cycle) single amplitude: 0.76 mm X, Y, Z each direction 2 hours	
Shock resistance	300 m/s ²	
Life	Mechanical : min. 5 million times (relay type), Electrical : 500,000 times min (resistive load)	
Ambient temperature & humidity	-10 ~ 50 °C, 35 ~ 85 % RH (without condensation)	

Electrode Level switch
Electrode Holder
Data storage device, Communication converter, Temperature and humidity converter

HY-ER3

Specifications

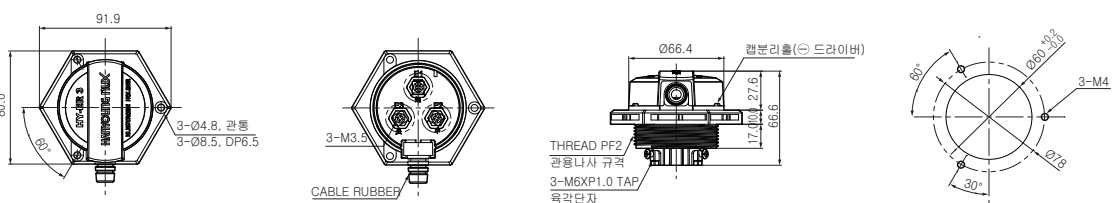
Appearance	Dimension
	 <p>91.9 80.0 3-Ø4.8, 3-핀홀 3-Ø8.5, DP6.5 3-M3.5 CABLE RUBBER Ø66.4 17.1, 27.6 66.6 THREAD PF2 / 관용나사 규격 3-M6XP1.0 TAP 육각단자 3-Ø8.5 3-M4 30° 80°</p>

Usage example

• Example of Water Supply connection (with FS-3A)

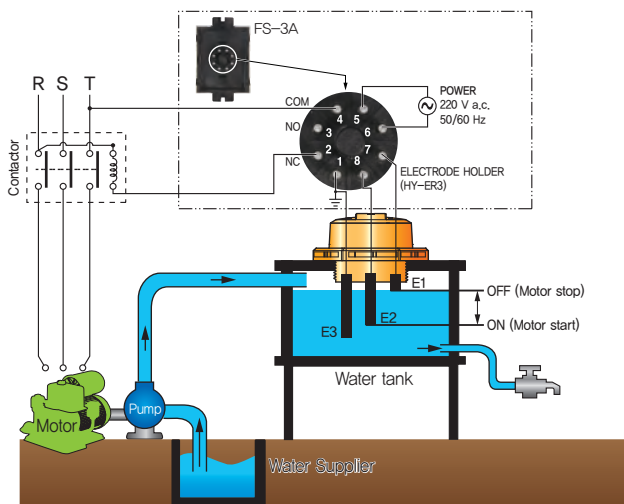

• Example of Drain connection (with FS-3A)

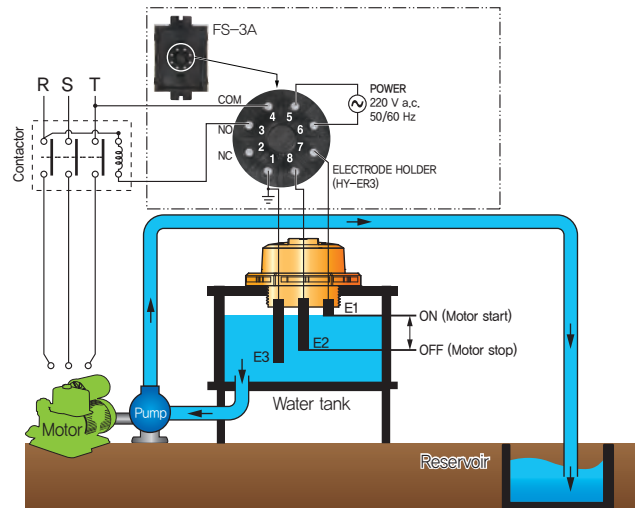





PROXIMITY SENSORS





UP series

Specifications



● Inductive DC 3 wire type

Model	NPN	UP8RM-1.5N□□	UP8RD-2N□□	UP12RM-2N□□	UP12RD-4N□□
	PNP	UP8RM-1.5P□□	UP8RD-2P□□	UP12RM-2P□□	UP12RD-4P□□
Appearance					
Shield	Shield		Non shield	Shield	Non shield
Standard sensing object (mm)	Iron 8 X 8 X 1			Iron 12 X 12 X 1	
Sensing distance	1.5 mm		2 mm	2 mm	4 mm
Setting distance	0 ~ 1.2 mm		0 ~ 1.6 mm	0 ~ 1.6 mm	0 ~ 3.2 mm
Hysteresis	Less than 10% of sensing distance				
Response frequency	800 Hz			800 Hz	400 Hz
Power voltage	12-24 V d.c. (Usable voltage range 5 - 35 V d.c.)				
Control output	200 mA max (Resistive load)				
Residual voltage	Max. 1.5 V				
Current consumption	Max. 6 mA				
Operation indication	Red LED				
Protection circuit	Power reversely connected protective circuit, surge protective circuit and over current protective circuit are built-in.				
Ambient temperature & humidity	-25 ~ 70 °C (Less than ±10 % of sensing distance at temperature 20 °C), 35 ~ 85 % RH				
Insulation resistance	Min. 50 MΩ (500 V d.c. mega standard)				
Dielectric strength	2000 V a.c. 50/60 Hz for 1 min. (between the recharging part and case)				
Vibration resistance	10 - 55 Hz (1 min cycle, double amplitude : 1.5 mm 2 hours for each of X, Y and Z directions)				
Shock resistance	500 m/s ² 3 times to each of X, Y and Z directions				
Degree of protection	IP67 (IEC 60529)				
Connection structure	● Cable type (standard cable length 2 m), ● Pin Connector type, ● Connector type				
Color	NPN : green, PNP : navy				
Material	● Case : stainless, ● Sensing surface : PBT, ● Cable holder : polyester elastomer			● Case : brass (chrome plating), ● Sensing surface : PBT, ● Cable holder : polyester elastomer	
Weight (g)	Cable	60	60	70	70
	Pin Connector	None	None	30	30
	Connector	None	None	30	30



● Inductive DC 3 wire type

Model	NPN	UP18RM-5N□□	UP18RD-8N□□	UP18RLM-5N□□	UP18RLD-8N□□
	PNP	UP18RM-5P□□	UP18RD-8P□□	UP18RLM-5P□□	UP18RLD-8P□□
Appearance					
Shield	Shield		Non shield	Shield	Non shield
Standard sensing object(mm)	Iron 18×18×1		Iron 25×25×1	Iron 18×18×1	Iron 25×25×1
Sensing distance	5 mm		8 mm	5 mm	8 mm
Setting distance	0 ~ 4 mm		0 ~ 6.4 mm	0 ~ 4 mm	0 ~ 6.4 mm
Hysteresis	Less than 10% of sensing distance				
Response frequency	350 Hz		200 Hz	350 Hz	200 Hz
Power voltage	12-24 V d.c. (Usable voltage range 5 - 35 V d.c.)				
Control output	200 mA max (Resistive load)				
Residual voltage	Max. 1.5 V				
Current consumption	Max. 6 mA				
Operation indication	Red LED				
Protection circuit	Power reversely connected protective circuit, surge protective circuit and over current protective circuit are built-in.				
Ambient temperature & humidity	-25 ~ 70 °C (Less than ±10 % of sensing distance at temperature 20 °C), 35 ~ 85 % RH				
Insulation resistance	Min. 50 MΩ (500 V d.c. mega standard)				
Dielectric strength	2,000 V a.c. 50/60 Hz for 1 min. (Between the recharging part and case)				
Vibration resistance	10 - 55 Hz (1 min cycle, double amplitude : 1.5 mm 2 hours for each of X, Y and Z directions)				
Shock resistance	500 m/s ² 3 times to each of X, Y and Z directions				
Degree of protection	IP67 (IEC 60529)				
Connection structure	● Cable type (standard cable length 2 m), ● Pin Connector type, ● Connector type				
Color	● NPN : green ● PNP : navy				
Material	● Case : brass (chrome plating), ● Sensing surface : PBT, ● Cable holder : polyester elastomer				
Weight (g)	Cable	120	120	140	140
	Pin Connector	80	80	100	100
	Connector	60	60	80	80

● Inductive DC 3 wire type

Model	NPN	UP30RM-10N□□	UP30RD-15N□□	UP30RLM-10N□□	UP30RLD-15N□□	
	PNP	UP30RM-10P□□	UP30RD-15P□□	UP30RLM-10P□□	UP30RLD-15P□□	
Appearance						
Shield	Shield		Non shield		Shield	
Standard sensing object (mm)	Iron 30×30×1		Iron 45×45×1		Iron 30×30×1	
Sensing distance	10 mm		15 mm		10 mm	
Setting distance	0 ~ 8 mm		0 ~ 12 mm		0 ~ 8 mm	
Hysteresis	Less than 10% of sensing distance					
Response frequency	250 Hz		100 Hz		250 Hz	
Power voltage	12-24 V d.c. (Usable voltage range 5 - 35 V d.c.)					
Control output	200 mA max (Resistive load)					
Residual voltage	Max. 1.5 V					
Current consumption	Max. 6 mA					
Operation indication	Red LED					
Protection circuit	● Power reverse connection protection circuit, ● Surge protection circuit, ● Over-current protection circuit built in					
Ambient temperature & humidity	-25 ~ 70 °C (Less than ±10 % of sensing distance at temperature 20 °C), 35 ~ 85 %RH					
Insulation resistance	Min. 50 MΩ (500 V d.c. mega standard)					
Dielectric strength	2000 V a.c. 50/60 Hz for 1 min (between the recharging part and case)					
Vibration resistance	10 - 55 Hz (1 min cycle, double amplitude : 1.5 mm 2 hours for each of X, Y and Z directions)					
Shock resistance	500 m/s ² 3 times to each of X, Y and Z directions					
Degree of protection	IP67 (IEC 60529)					
Connection structure	● Cable type (standard cable length 2 m), ● Pin Connector type, ● Connector type					
Color	● NPN : green ● PNP : navy					
Material	● Case : brass (chrome plating) ● Sensing surface : PBT ● Cable holder : polyester elastomer					
Weight (g)	Cable	170	170	220	220	
	Pin Connector	130	130	180	180	
	Connector	150	150	200	200	

● Inductive DC 2 wire type (Polarity / No polarity)

Model	Polar	UP8RM-1.5T□□	UP8RD-2T□□	UP12RM-2T□□	UP12RD-4T□□	
	No polarity	-	-	UP12RM-2U□□	UP12RD-4U□□	
Appearance						
Shield	Shield		Non shield		Shield	
Standard sensing object (mm)	Iron 8×8×1		Iron 8×8×1		Iron 12×12×1	
Sensing distance	1.5 mm		2 mm		2 mm	
Setting distance	0 ~ 1.2 mm		0 ~ 1.6 mm		0 ~ 1.6 mm	
Hysteresis	Less than 10% of sensing distance					
Response frequency	800 Hz		800 Hz		400 Hz	
Power voltage	12-24 V d.c. (Usable voltage range 5 - 30 V d.c.)					
Control output	100 mA max (Resistive load)					
Residual voltage	● T(Polarity) : max. 3.5 V ● U(No polarity) : max. 5 V					
Leakage current	Max. 1 mA					
Operation indication	Red LED					
Protection circuit	Surge protective circuit and over current protective circuit are built-in.					
Ambient temperature & humidity	-25 ~ 70 °C (Less than ±10 % of sensing distance at temperature 20 °C), 35 ~ 85 % RH					
Insulation resistance	Min. 50 MΩ (500 V d.c. mega standard)					
Dielectric strength	2,000 V a.c. 50/60 Hz for 1 min (between the recharging part and case)					
Vibration resistance	10 - 55 Hz (1 min cycle, double amplitude: 1.5 mm 2 hours for each of X, Y and Z directions)					
Shock resistance	500 m/s ² 3 times to each of X, Y and Z directions					
Degree of protection	IP67 (IEC 60529)					
Connection structure	● Cable type (standard cable length 2 m), ● Pin Connector type, ● Connector type					
Color	● NO : green ● NC : navy					
Material	● Case: stainless ● Sensing surface: PBT ● Cable holder : polyester elastomer			● Case: brass (chrome plating) ● Sensing surface: PBT ● Cable holder : polyester elastomer		
Weight (g)	Cable	60		70		
	Pin Connector	None		30		
	Connector	None		30		

Columnar

Square





Thin

Capacitive Type





Connector Cable

PROXIMITY SENSORS



● Inductive DC 2 wire type (Polarity / No polarity) CE

Model	Polar	UP18RM-5T□□	UP18RD-8T□□	UP18RLM-5T□□	UP18RLD-8T□□
	No polarity	UP18RM-5U□□	UP18RD-8U□□	UP18RLM-5U□□	UP18RLD-8U□□
Appearance					
Shield		Shield	Non shield	Shield	Non shield
Standard sensing object (mm)		Iron 18×18×1	Iron 25×25×1	Iron 18×18×1	Iron 25×25×1
Sensing distance		5 mm	8 mm	5 mm	8 mm
Setting distance		0 ~ 4 mm	0 ~ 6.4 mm	0 ~ 4 mm	0 ~ 6.4 mm
Hysteresis		Less than 10% of sensing distance			
Response frequency		350 Hz	200 Hz	350 Hz	200 Hz
Power voltage		12-24 V d.c. (Usable voltage range 5 - 30 V d.c.)			
Control output		100 mA max (Resistive load)			
Residual voltage		● T (Polarity) : max. 3.5 V, ● U (no polarity): max. 5 V			
Leakage current		Max. 1 mA			
Operation indication		Red LED			
Protection circuit		Surge protective circuit and over current protective circuit are built-in.			
Ambient temperature & humidity		-25 ~ 70 °C (Less than ±10 % of sensing distance at temperature 20 °C), 35 ~ 85 % RH			
Insulation resistance		Min. 50 MΩ (500 V d.c. mega standard)			
Dielectric strength		2,000 V a.c. 50/60 Hz for 1 min (between the recharging part and case)			
Vibration resistance		10 - 55 Hz (1 min cycle, double amplitude : 1.5 mm 2 hours for each of X, Y and Z directions)			
Shock resistance		500 m/s ² 3 times to each of X, Y and Z directions			
Degree of protection		IP67 (IEC 60529)			
Connection structure		● Cable type (standard cable length 2 m), ● Pin Connector type, ● Connector type			
Color		● NO : green ● NC : navy			
Material		● Case : brass (chrome plating) ● Sensing surface : PBT ● Cable holder : polyester elastomer			
Weight (g)	Cable	120	120	140	140
	Pin Connector	80	80	100	100
	Connector	60	60	80	80

● Inductive DC 2 wire type (Polarity / No polarity) CE

Model	Polar	UP30RM-10T□□	UP30RD-15T□□	UP30RLM-10T□□	UP30RLD-15T□□
	No polarity	UP30RM-10U□□	UP30RD-15U□□	UP30RLM-10U□□	UP30RLD-15U□□
Appearance					
Shield		Shield	Non shield	Shield	Non shield
Standard sensing object (mm)		Iron 30×30×1	Iron 45×45×1	Iron 30×30×1	Iron 45×45×1
Sensing distance		10 mm	15 mm	10 mm	15 mm
Setting distance		0 ~ 8 mm	0 ~ 12 mm	0 ~ 8 mm	0 ~ 12 mm
Hysteresis		Less than 10% of sensing distance			
Response frequency		250 Hz	100 Hz	250 Hz	100 Hz
Power voltage		12-24 V d.c. (Usable voltage range 5 - 30 V d.c.)			
Control output		100 mA max (Resistive load)			
Residual voltage		● T (polarity): max. 3.5 V, ● U (no polarity): max. 5 V			
Leakage current		Max. 1 mA			
Operation indication		Red LED			
Protection circuit		Surge protective circuit and over current protective circuit are built-in.			
Ambient temperature & humidity		-25 ~ 70 °C (Less than ±10 % of sensing distance at temperature 20 °C), 35 ~ 85 % RH			
Insulation resistance		Min. 50 MΩ (500 V d.c. mega standard)			
Dielectric strength		2,000 V a.c. 50/60 Hz for 1 min (between the recharging part and case)			
Vibration resistance		10 - 55 Hz (1 min cycle, double amplitude : 1.5 mm 2 hours for each of X, Y and Z directions)			
Shock resistance		500 m/s ² 3 times to each of X, Y and Z directions			
Degree of protection		IP67 (IEC 60529)			
Connection structure		● Cable type (standard cable length 2 m), ● Pin Connector type, ● Connector type			
Color		● NO : green ● NC : navy			
Material		● Case : brass (chrome plating) ● Sensing surface : PBT ● Cable holder: polyester elastomer			
Weight (g)	Cable	170		220	
	Pin Connector	130		180	
	Connector	150		200	

● Inductive AC 2 wire type

Model	UP12RM-2A□□	UP12RD-4A□□
Appearance		
Shield	Shield	Non shield
Standard sensing object (mm)	Iron 12×12×1	
Sensing distance	2 mm	4 mm
Setting distance	0 ~ 1.6 mm	0 ~ 3.2 mm
Hysteresis	Less than 10 % of sensing distance	
Response frequency	20 Hz	
Power voltage	100-240 V a.c. 50-60 Hz (Usable voltage range 90 - 250 V a.c. 50-60 Hz)	
Control output	200 mA max (Resistive load)	
Residual voltage	Max. 10 V	
Leakage current	Max. 2.2 mA	
Operation indication	Red LED	
Protection circuit	Surge protective circuit built-in.	
Ambient temperature & humidity	-25 ~ 70 °C (less than ±10 % of sensing distance at temperature 20 °C), 35 ~ 85 %RH	
Insulation resistance	Min. 50 MΩ (500 V d.c. mega standard)	
Dielectric strength	2,000 V a.c. 50/60 Hz for 1 min (between the recharging part and case)	
Vibration resistance	10 - 55 Hz (1 min cycle, double amplitude: 1.5 mm 2 hours for each of X, Y and Z directions)	
Shock resistance	500 m/s ² 3 times to each of X, Y and Z directions	
Degree of protection	IP67 (IEC 60529)	
Connection structure	● Cable type (standard cable length 2 m), ● Pin Connector type, ● Connector type	
Color	● NO : green ● NC : navy	
Material	● Case : brass (chrome plating) ● Sensing surface : PBT ● Cable holder : polyester elastomer	
Weight (g)	Cable	70
	Pin Connector	30
	Connector	30





Columnar
Square
Thin
Capacitive Type
Connector Cable

● Inductive AC 2 wire type

Model	UP18RM-5A□□	UP18RD-8A□□	UP18RLM-5A□□	UP18RLD-8A□□
Appearance				
Shield	Shield	Non shield	Shield	Non shield
Standard sensing object (mm)	Iron 18×18×1	Iron 25×25×1	Iron 18×18×1	Iron 25×25×1
Sensing distance	5 mm	8 mm	5 mm	8 mm
Setting distance	0 ~ 4 mm	0 ~ 6.4 mm	0 ~ 4 mm	0 ~ 6.4 mm
Hysteresis	Less than 10 % of sensing distance			
Response frequency	20 Hz			
Power voltage	100-240 V a.c. 50-60 Hz (Usable voltage range 90 - 250 V a.c. 50-60 Hz)			
Control output	Max. 200 mA (resistive load)			
Residual voltage	Max. 10 V			
Leakage current	Max. 2.2 mA			
Operation indication	Red LED			
Protection circuit	Surge protective circuit built-in.			
Ambient temperature & humidity	-25 ~ 70 °C (less than ±10 % of sensing distance at temperature 20 °C), 35 ~ 85 %RH			
Insulation resistance	Min. 50 MΩ (500 V d.c. mega standard)			
Dielectric strength	2000 V a.c. 50/60 Hz for 1 min (between the recharging part and case)			
Vibration resistance	10 - 55 Hz (1 min cycle, double amplitude : 1.5 mm 2 hours for each of X, Y and Z directions)			
Shock resistance	500 m/s ² 3 times to each of X, Y and Z directions			
Degree of protection	IP67 (IEC 60529)			
Connection structure	● Cable type (standard cable length 2 m), ● Pin Connector type, ● Connector type			
Color	● NO : green ● NC : navy			
Material	● Case : brass (chrome plating) ● Sensing surface : PBT ● Cable holder : polyester elastomer			
Weight (g)	Cable	120	140	
	Pin Connector	80	100	
	Connector	60	80	

PROXIMITY SENSORS

● Inductive AC 2 wire type

Model	UP30RM-10A□□	UP30RD-15A□□	UP30RLM-10A□□	UP30RLD-15A□□	
Appearance					
Shield	Shield	Non shield	Shield	Non shield	
Standard sensing object (mm)	Iron 30×30×1	Iron 45×45×1	Iron 30×30×1	Iron 45×45×1	
Sensing distance	10 mm	15 mm	10 mm	15 mm	
Setting distance	0 ~ 8 mm	0 ~ 12 mm	0 ~ 8 mm	0 ~ 12 mm	
Hysteresis	Less than 10 % of sensing distance				
Response frequency	20 Hz				
Power voltage	100-240 V a.c. 50-60 Hz (Usable voltage range 90 - 250 V a.c. 50-60 Hz)				
Control output	Max. 200 mA (Resistive load)				
Residual voltage	Max. 10 V				
Leakage current	Max. 2.2 mA				
Operation indication	Red LED				
Protection circuit	Surge protective circuit built-in.				
Ambient temperature & humidity	-25 ~ 70 °C (Less than ±10 % of sensing distance at temperature 20 °C), 35 ~ 85 % RH				
Insulation resistance	Min. 50 MΩ (500 V d.c. mega standard)				
Dielectric strength	2000 V a.c. 50/60 Hz for 1 min (between the recharging part and case)				
Vibration resistance	10 - 55 Hz (1 min cycle, double amplitude: 1.5 mm 2 hours for each of X, Y and Z directions)				
Shock resistance	500 m/s ² 3 times to each of X, Y and Z directions				
Degree of protection	IP67 (IEC 60529)				
Connection structure	● Cable type (standard cable length 2 m), ● Pin Connector type, ● Connector type				
Color	● NO : green ● NC : navy				
Material	● Case : brass (chrome plating) ● Sensing surface : PBT ● Cable holder : polyester elastomer				
Weight (g)	Cable	170	170	220	220
	Pin Connector	130	130	180	180
	Connector	150	150	200	200

■ Suffix code (Round type)



Model	Code	Content
UP	□ □ □ □ □ □	Inductive Type Proximity Sensor
Sensing area size	8	M8
	12	M12
	18	M18
	30	M30
Structure type	RM	Round type Shield
	RD	Round type Non Shield
	RLM	Long round type Shield (M8 and M12 are excluded)
	RLD	Long round type Non Shield (M8 and M12 are excluded)
Sensing distance	1.5	only with UP8-RM1.5
	2	only with UP8-RD2, UP12-RM2
	4	only with UP12-RD4
	5	only with UP18-RM5, UP18-RLM5
	8	only with UP18-RD8, UP18-RLD8
	10	only with UP30-RM10, UP30-RLM10
Power and output type	N	DC NPN output
	P	DC PNP output
	A	AC 2 wire type
	T	DC 2 wire type (polarity)
	U	DC 2 wire type (no polarity) ※ But M8 is excluded
Output state	A	Normal Open (N.O)
	C	Normal Close (N.C)
Connection structure		None (Cable type)
	CR	Pin Connector type
	C	Connector type

※ Note) M8(8)8 type is cable type only.



UP series

Specifications

● Inductive DC 3 wire type **CE**

Model	NPN	UP12S-4N □ □	UP18S-5N □ □	UP18S-8N □ □
	PNP	UP12S-4P □ □	UP18S-5P □ □	UP18S-8P □ □
Appearance				
Standard sensing object(mm)	Iron 12X12X1		Iron 18X18X1	Iron 25X25X1
Sensing distance	4 mm		5 mm	8 mm
Setting distance	0 ~ 3.2 mm		0 ~ 4 mm	0 ~ 6.4 mm
Hysteresis	Less than 10 % of sensing distance			
Response frequency	800 Hz		350 Hz	250 Hz
Power voltage	12-24 V d.c. (Usable voltage range 5 - 35 V d.c.)			
Control output	Open/Close capacitance	200 mA max (Resistive load)		
	Residual voltage	Max. 1.5 V		
Current consumption	Max. 6 mA			
Operation indication	Red LED			
Protective circuit	● Power reversely connected protective circuit, ● Surge protective circuit and over current protective circuit are built-in.			
Degree of protection	IP67 (IEC 60529)			
Connection structure	● Cable type (standard cable length 2 m), ● Pin Connector type			
Ambient temperature & humidity	-25 ~ 70 °C (Less than ±10 % of sensing distance at temperature 20 °C), 35 ~ 85 %RH			
Insulation resistance	Min. 50 MΩ (500 V d.c. mega standard)			
Dielectric strength	2000 V a.c. 50/60 Hz for 1 min (between the recharging part and case)			
Vibration resistance	10 ~ 55 Hz (1 min cycle, double amplitude : 1.5 mm 2 hours for each of X, Y and Z directions)			
Shock resistance	500 m/s ² 3 times to each of X, Y and Z directions			
Material	● Case : PBT resin, ● Cable holder : polyester elastomer			
Weight(g)	Cable type	45	60	60
	Pin Connector type	15	20	20

● Inductive DC 3 wire type **CE**

Model	NPN	UP25S-5N □ □	UP25S-8N □ □	UP25S-12N □ □	UP30S-10N □ □	UP30S-15N □ □	UP40S-20N □ □
	PNP	UP25S-5P □ □	UP25S-8P □ □	UP25S-12P □ □	UP30S-10P □ □	UP30S-15P □ □	UP40S-20P □ □
Appearance							
Standard sensing object(mm)	Iron 25 X 25 X 1	Iron 30 X 30 X 1	Iron 35 X 35 X 1	Iron 30 X 30 X 1	Iron 45 X 45 X 1	Iron 60 X 60 X 1	
Sensing distance	5 mm	8 mm	12 mm	10 mm	15 mm	20 mm	
Setting distance	0 ~ 4 mm	0 ~ 6.4 mm	0 ~ 9.6 mm	0 ~ 8 mm	0 ~ 12 mm	0 ~ 16 mm	
Hysteresis	Less than 10% of sensing distance						
Response frequency	350 Hz	250 Hz	200 Hz	250 Hz	100 Hz	100 Hz	
Power voltage	12-24 V d.c. (Usable voltage range 5 - 35 V d.c.)						
Control output	Open/Close capacitance	200 mA max (Resistive load)					
	Residual voltage	Max. 1.5 V					
Current consumption	Max. 6 mA						
Operation indication	Red LED						
Protective circuit	● Power reversely connected protective circuit, ● Surge protective circuit and over current protective circuit are built-in.						
Degree of protection	IP67 (IEC 60529)						
Connection structure	● Cable type (standard cable length 2 m), ● Pin Connector type						
Ambient temperature & humidity	-25 ~ 70 °C (less than ±10 % of sensing distance at temperature 20 °C), 35 ~ 85 % RH						
Insulation resistance	Min. 50 MΩ (500 V d.c. mega standard)						
Dielectric strength	2,000Va.c. 50/60 Hz for 1 min (between the recharging part and case)						
Vibration resistance	10 ~ 55 Hz (1 min cycle, double amplitude : 1.5 mm 2 hours for each of X, Y and Z directions)						
Shock resistance	500 m/s ² 3 times to each of X, Y and Z directions						
Material	● Case : PBT resin, ● Cable holder : polyester elastomer						
Weight(g)	Cable type	80	80	80	90	90	110
	Pin Connector type	40	40	40	60	60	80

Columnar

Square



Thin

Capacitive Type



Connector Cable

PROXIMITY SENSORS



● Inductive DC 2 wire type

Model	NPN	UP12S-4T □ □	UP18S-5T □ □	UP18S-8T □ □
	PNP	UP12S-4U □ □	UP18S-5U □ □	UP18S-8U □ □
Appearance				
Standard sensing object(mm)	Iron 12X12X1		Iron 18X18X1	Iron 25X25X1
Sensing distance	4 mm		5 mm	8 mm
Setting distance	0 ~ 3.2 mm		0 ~ 4 mm	0 ~ 6.4 mm
Hysteresis	Less than 10 % of sensing distance			
Response frequency	500 Hz		350 Hz	250 Hz
Power voltage	12-24 V d.c. (Usable voltage range 5 - 30 V d.c.)			
Control output	Open/Close capacitance	Max. 100 mA (resistive load)		
	Residual voltage	● T(Polarity) : max. 3.5 V ● U(No polarity) : max. 5 V		
Current consumption	1 mA or less			
Operation indication	Red LED			
Protective circuit	● Power reversely connected protective circuit, ● Surge protective circuit and over current protective circuit are built-in.			
Degree of protection	IP67 (IEC 60529)			
Connection structure	● Cable type (standard cable length 2 m), ● Pin Connector type			
Ambient temperature & humidity	-25 ~ 70 °C (less than ±10 % of sensing distance at temperature 20 °C), 35 ~ 85 %RH			
Insulation resistance	Min. 50 MΩ (500 V d.c. mega standard)			
Dielectric strength	2000 V a.c. 50/60 Hz for 1 min (between the recharging part and case)			
Vibration resistance	10 ~ 55 Hz (1 min cycle, double amplitude: 1.5 mm 2 hours for each of X, Y and Z directions)			
Shock resistance	500 m/s ² 3 times to each of X, Y and Z directions			
Material	● Case : PBT resin, ● Cable holder : polyester elastomer			
Weight(g)	Cable type	45	60	60
	Pin Connector type	15	20	20

● Inductive DC 2 wire type

Model	NPN	UP25S-5T □ □	UP25S-8T □ □	UP25S-12T □ □	UP30S-10T □ □	UP30S-15T □ □	UP40S-20T □ □
	PNP	UP25S-5U □ □	UP25S-8U □ □	UP25S-12U □ □	UP30S-10U □ □	UP30S-15U □ □	UP40S-20U □ □
Appearance							
Standard sensing object(mm)	Iron 25 X 25 X 1	Iron 30 X 30 X 1	Iron 35 X 35 X 1	Iron 30 X 30 X 1	Iron 45 X 45 X 1	Iron 60 X 60 X 1	
Sensing distance	5 mm	8 mm	12 mm	10 mm	15 mm	20 mm	
Setting distance	0 ~ 4 mm	0 ~ 6.4 mm	0 ~ 9.6 mm	0 ~ 8 mm	0 ~ 12 mm	0 ~ 16 mm	
Hysteresis	Less than 10 % of sensing distance						
Response frequency	350 Hz	250 Hz	200 Hz	250 Hz	100 Hz	100 Hz	
Power voltage	12-24 V d.c. (usable voltage range 5 - 30 V d.c.)						
Control output	Open/Close capacitance	Max. 100 mA (resistive load)					
	Residual voltage	● T (polarity): max. 3.5 V ● U (Non polarity): max. 5 V					
Current consumption	Max. 1 mA						
Operation indication	Red LED						
Protective circuit	● Power reversely connected protective circuit, ● Surge protective circuit and over current protective circuit are built-in.						
Degree of protection	IP67 (IEC 60529)						
Connection structure	● Cable type (standard cable length 2 m), ● Pin Connector type						
Ambient temperature & humidity	-25 ~ 70 °C (less than ±10 % of sensing distance at temperature 20 °C), 35 ~ 85 %RH						
Insulation resistance	Min. 50 MΩ (500 V d.c. mega standard)						
Dielectric strength	2000 V a.c. 50/60 Hz for 1 min (between the recharging part and case)						
Vibration resistance	10 ~ 55 Hz (1 min cycle, double amplitude : 1.5 mm 2 hours for each of X, Y and Z directions)						
Shock resistance	500 m/s ² 3 times to each of X, Y and Z directions						
Material	● Case : PBT resin, ● Cable holder : polyester elastomer						
Weight(g)	Cable type	80	80	80	90	90	110
	Pin Connector type	40	40	40	60	60	80

● Inductive AC 2 wire type **CE**

Model	For AC	UP25S-5A □ □	UP25S-8A □ □	UP30S-10A □ □
Appearance				
Standard sensing object(mm)		Iron 25 X 25 X 1		Iron 30 X 30 X 1
Sensing distance		5 mm	8 mm	10 mm
Setting distance		0 ~ 4 mm	0 ~ 6.4 mm	0 ~ 8 mm
Hysteresis		Less than 10% of sensing distance		
Response frequency		20 Hz		
Power voltage		100-240 V a.c. 50-60 Hz (Usable voltage range 90 - 250 V a.c.50-60 Hz)		
Control output	Open/Close capacitance	Max. 200 mA (resistive load)		
	Residual voltage	Max. 10 V a.c.		
Current consumption		Max. 2.2 mA		
Operation indication		Red LED		
Protective circuit		Surge protective circuit is built-in.		
Degree of protection		IP67 (IEC 60529)		
Connection structure		● Cable type (standard cable length 2 m), ● Pin Connector type		
Ambient temperature & humidity		-25 ~ 70 °C (less than ±10 % of sensing distance at temperature 20 °C), 35 ~ 85 %RH		
Insulation resistance		Min. 50 MΩ (500 V d.c. mega standard)		
Dielectric strength		2,000 V a.c. 50/60 Hz for 1 min (between the recharging part and case)		
Vibration resistance		10 ~ 55 Hz (1 min cycle, double amplitude : 1.5 mm 2 hours for each of X, Y and Z directions)		
Shock resistance		500 m/s ² X·Y·Z 3 times to each of X, Y and Z directions		
Material		● Case : PBT resin, ● Cable holder : polyester elastomer		
Weight(g)	Cable type	80	80	90
	Pin Connector type	40	40	80

Columnar



Square

Thin

Capacitive Type

Connector Cable

● Inductive AC 2 wire type **CE**

Model	For AC	UP30S-15A □ □	UP40S-20A □ □
Appearance			
Standard sensing object(mm)		Iron 45 X 45 X 1	Iron 60 X 60 X 1
Sensing distance		15 mm	20 mm
Setting distance		0 ~ 12 mm	0 ~ 16 mm
Hysteresis		Less than 10% of sensing distance	
Response frequency		20 Hz	
Power voltage		100-240 V a.c. 50-60 Hz (Usable voltage range 90 - 250 V a.c.50-60 Hz)	
Control output	Open/Close capacitance	Max. 200 mA (resistive load)	
	Residual voltage	Max. 10 V a.c.	
Current consumption		Max. 2.2 mA	
Operation indication		Red LED	
Protective circuit		Surge protective circuit is built-in.	
Degree of protection		IP67 (IEC 60529)	
Connection structure		● Cable type (standard cable length 2 m), ● Pin Connector type	
Ambient temperature & humidity		-25 ~ 70 °C (less than ±10 % of sensing distance at temperature 20 °C), 35 ~ 85 %RH	
Insulation resistance		Min. 50 MΩ (500 V d.c. mega standard)	
Dielectric strength		2,000 V a.c. 50/60 Hz for 1 min (between the recharging part and case)	
Vibration resistance		10 ~ 55 Hz (1 min cycle, double amplitude: 1.5 mm 2 hours for each of X, Y and Z directions)	
Shock resistance		500 m/s ² 3 times to each of X, Y and Z directions	
Material		● Case : PBT resin, ● Cable holder : polyester elastomer	
Weight(g)	Cable type	90	110
	Pin Connector type	60	80

PROXIMITY SENSORS

Suffix code(Square type)

Model	Code	Content
UP	□ □ □ □ □ □ □ □	Inductive Type Proximity Sensor
Sensing area size	12	12(W) × 12(H) mm
	18	18(W) × 18(H) mm
	25	25(W) × 25(H) mm
	30	30(W) × 30(H) mm
	40	40(W) × 40(H) mm
Structure type	S	Square type
Sensing distance	2	2 mm (only with UP8S-2)
	4	4 mm (only with UP12S-4)
	5	5 mm (only with UP18S-5, UP25S-5)
	8	8 mm (only with UP18S-8, UP25S-8)
	10	10 mm (only with UP30S-10)
	12	12 mm (only with UP25S-12)
	15	15 mm (only with UP30S-15)
Power and output type	N	DC NPN output
	P	DC PNP output
	A	AC 2 wire type (but UP18S is excluded)
	T	DC 2 wire type (polarity)
	U	DC 2 wire type (no polarity)
Output state	A	Normal Open (NO)
	C	Normal Close (NC)
Sensing direction		Detect Front side
	U	Detect upper side (only available with the square type UP18S)
Connection structure		Cable type
	CR	Pin Connector type

UP series

Specifications

● Inductive DC 3 wire type / 2 wire type



Model	DC 3 wire type		DC 2 wire type	
	NPN	UP25F-8N□□	Polarity	UP25F-8T□□
	PNP	UP25F-8P□□	No polarity	UP25F-8U□□
Appearance				
Standard sensing object(mm)	Iron 25 X 25 X 1			
Sensing distance	8 mm			
Setting distance	0 ~ 6.4 mm			
Hysteresis	Less than 10 % of sensing distance			
Response frequency	200 Hz			
Power voltage	12-24 V d.c. (Usable voltage range 5 - 35 V d.c.)		12-24 V d.c. (Usable voltage range 5 - 30 V d.c.)	
Control output	200 mA max (Resistive load)		100 mA max (Resistive load)	
Residual voltage	Max. 1.5 V		● Polarity : max. 3.5 V, ● No polarity : max. 5 V	
Current consumption	Max. 6 mA		-	
Leakage current	-		Max. 1 mA	
Operation indication	Red LED			
Protection circuit	● Power reversely connected protective circuit, ● surge protective circuit and over current protective circuit are built-in.		● surge protective circuit and over current protective circuit are built-in.	
Ambient temperature & humidity	-25 ~ 70 °C (less than ±10 % of sensing distance at temperature 20 °C), 35 ~ 85 %RH			
Insulation resistance	Min. 50 MΩ (500 V d.c. mega standard)			
Dielectric strength	2,000 V a.c. 50/60 Hz for 1 min (between the recharging part and case)			
Vibration resistance	10 - 55 Hz (1 min cycle, double amplitude: 1.5 mm 2 hours for each of X, Y and Z directions)			
Shock resistance	500 m/s ² X·Y·Z 3 times to each of X, Y and Z directions			
Degree of protection	IP67 (IEC 60529)			
Connection structure	● Cable type (standard cable length 2 m), ● Pin Connector type			
Color	● Polarity : green ● No polarity : navy			
Material	● Case : PBT resin ● Cable holder: polyester elastomer			
Weight(g)	Cable type	60		60
	Pin Connector type	20		20

● Inductive AC 2 wire type

Model	UP25F-8A□□	
Appearance		
Standard sensing object(mm)	Iron 25 X 25 X 1	
Sensing distance	8 mm	
Setting distance	0 ~ 6.4 mm	
Hysteresis	Less than 10 % of sensing distance	
Response frequency	20 Hz	
Power voltage	100-240 V a.c. 50-60 Hz (usable voltage range 90-250 V a.c. 50-60 Hz)	
Control output	Max. 200 mA (resistive load)	
Residual voltage	Max. 10 V a.c.	
Leakage current	Max. 2.2 mA	
Operation indication	Red LED	
Protection circuit	Surge protective circuit built-in.	
Ambient temperature & humidity	-25 ~ 70 °C ((less than ±10 % of sensing distance at temperature 20 °C), 35 ~ 85 % RH)	
Insulation resistance	Min. 50 MΩ (500V d.c. mega standard)	
Dielectric strength	2,000 V a.c. 50/60 Hz for 1 min (between the recharging part and case)	
Vibration resistance	10 - 55 Hz (1 min cycle, double amplitude : 1.5 mm 2 hours for each of X, Y and Z directions)	
Shock resistance	500 m/s ² 3 times to each of X, Y and Z directions	
Degree of protection	IP67 (IEC 60529)	
Connection structure	● Cable type (standard cable length 2 m), ● Pin Connector type	
Color	● NO : green, ● NC : navy	
Material	● Case : PBT resin ● Cable holder : polyester elastomer	
Weight(g)	Cable type	60
	Pin Connector type	20

Columnar
Square
Thin
Capacitive Type
Connector Cable

Suffix code (Flat type)





Model	Code	Content
UP	□ □ □ □ □ □	Inductive Type Proximity Sensor
Sensing area size	25	Please refer to the dimension (25.7×49.0×10.5)
Structure type	F	Flat Type
Sensing distance	8	8 mm
Power and output type	N	DC NPN output
	P	DC PNP output
	A	AC 2 wire type
	T	DC 2 wire type (polarity)
	U	DC 2 wire type (no polarity)
Output state	A	Normal Open (NO)
	C	Normal Close (NC)
Connection structure		None (Cable type)
	CR	Pin Connector

PROXIMITY SENSORS



CUP series CE

Specifications

● Capacitive DC 3 wire type

Model	NPN	CUP18R-8N□□	CUP18RP-8N□□	CUP30R-15N□□	CUP30RP-15N□□
	PNP	CUP18R-8P□□	CUP18RP-8P□□	CUP30R-15P□□	CUP30RP-15P□□
Appearance					
Shield	Non shield				
Standard sensing object (mm)	Iron 50 X 50 X 1 (Grounded <earthed> state)				
Sensing distance	8 mm (Volume variation)			15 mm (Volume variation)	
Setting distance	0 ~ 6.4 mm			0 ~ 12 mm	
Hysteresis	Less than 20 % of sensing distance				
Response frequency	50Hz				
Power voltage	12-24 V d.c. (Usable voltage range 10 - 30 V d.c.)				
Control output	200 mA max (Resistive load)				
Residual voltage	Max. 1.5 V				
Current consumption	Max. 10 mA				
Operation indication	Red LED				
Protection circuit	Power reversely connected protective circuit, surge protective circuit and over current protective circuit are built-in.				
Ambient temperature & humidity	-25 ~ 70 °C (less than ±10 % of sensing distance at temperature 20 °C), 35 ~ 85 %RH				
Insulation resistance	Min. 50 MΩ (500 V d.c. mega standard)				
Dielectric strength	2,000 V a.c. 50/60 Hz for 1 min (between the recharging part and case)				
Vibration resistance	10 - 55 Hz (1 min cycle, double amplitude : 1.5 mm 2 hours for each of X, Y and Z directions)				
Shock resistance	500 m/s ² X·Y·Z 3 times to each of X, Y and Z directions				
Degree of protection	IP67 (IEC 60529)				
Connection structure	● Cable type (standard cable length 2 m), ● Pin Connector type, ● Connector type				
Color	● NPN : green ● PNP : navy				
Material	● CUP-18R/CUP-30R Case : brass (chrome plated) ● Detection surface : PBT ● CUP-18RP/CUP-30RP Integrated casing and detection surface: PBT				
Weight(g)	Cable type	70	70	120	120
	Pin Connector type	30	30	80	80

● Capacitive type, DC/AC dual usage 2 wire type

Model	CUP18R-8F□□	CUP18RP-8F□□	CUP30R-15F□□	CUP30RP-15F□□
Appearance				
Shield	Non shield			
Standard sensing object(mm)	Iron 50 X 50 X 1 (Grounded <earthed> state)			
Sensing distance	8 mm (Volume variation)		15 mm (Volume variation)	
Setting distance	0 ~ 6.4 mm		0 ~ 12 mm	
Hysteresis	Less than 20% of sensing distance			
Response frequency	● DC : 40 Hz ● AC : 20 Hz			
Power voltage	20-240 V a.c. 50-60 Hz/20-240 V d.c. (usable voltage range 18-250 V a.c. 50-50 Hz, 250 V d.c.)			
Control output	Switching capacity : 5-250 mAd.c. or less (resistive load), residual voltage : 7 V or less (AC/DC)			
Residual voltage	Max. 7 V (AC/DC)			
Leakage current	Max. 2 mA			
Operation indication	Red LED			
Protection circuit	Surge protective circuit built-in.			
Ambient temperature & humidity	-25 ~ 70 °C (less than ±10 % of sensing distance at temperature 20 °C), 35 ~ 85 %RH			
Insulation resistance	Min. 50 MΩ (500 V d.c. mega standard)			
Dielectric strength	2,000 V a.c. 50/60 Hz for 1 min (between the recharging part and case)			
Vibration resistance	10 - 55 Hz (1 min cycle, double amplitude : 1.5 mm 2 hours for each of X, Y and Z directions)			
Shock resistance	500 m/s ² 3 times to each of X, Y and Z directions			
Degree of protection	IP67 (IEC 60529)			
Connection structure	● Cable type (standard cable length 2 m), ● Pin Connector type, ● Connector type			
Case	Brass (Chrome plating)	PTB resin	Brass (Chrome plating)	PTB resin
Color	● NO : green ● NC : navy	NO/NC: green	● NO: green ● NC : navy	NO/NC : green
Material	● CUP-18R/CUP-30R (Case: brass chrome plating, sensing surface: PBT resin) ● CUP-18RP/CUP-30RP (Case and sensing surface one body type: PBT resin)			
Weight(g)	Cable type	70	70	120
	Pin Connector type	30	30	80

Suffix code (Capacitive type)

Model	Code	Content
CUP -	<input type="checkbox"/> <input type="checkbox"/> <input type="checkbox"/> <input type="checkbox"/> <input type="checkbox"/> <input type="checkbox"/>	Capacitive Type Proximity Sensor
Sensing area size	18	M18
	30	M30
Structure type	R	Round type (Brass chrome plating case)
	RP	Round type (Plastic case)
Sensing distance	8	8 mm (only with CUP-18□-8)
	15	15 mm (only with CUP-30□-15)
Power and output type	N	DC NPN output
	P	DC PNP output
	F	AC/DC 2 wire type (dual usage) (no polarity)
Output state	A	Normal Open (NO)
	C	Normal Close (NC)
Connection structure		None (Cable type)
	CR	Pin Connector type

Columnar

Square



Thin

Capacitive Type

Connector Cable

Connector Cable

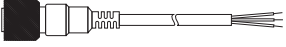
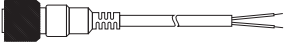
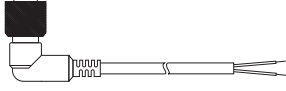
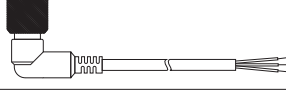
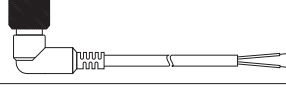
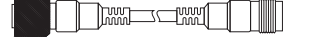
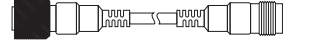
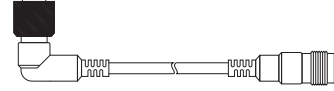
Specifications

Classification	Appearance	Model	Cable length	Usage power	
Connector cable		AA2S-2M	2 m	AC 2 wire	
		AA2S-5M	5 m		
		AD3S-2M	2 m	DC 3 wire	
		AD3S-5M	5 m		
		AD2S-2M	2 m	DC 2 wire	
		AD2S-5M	5 m		
		AA2A-2M	2 m	AC 2 wire	
		AA2A-5M	5 m		
			AD3A-2M	2 m	DC 3 wire
			AD3A-5M	5 m	
		AD2A-2M	2 m	DC 2 wire	
		AD2A-5M	5 m		
Relay cable		BA4S-2M	2 m	AC	
		BA4S-5M	5 m		
		BD4S-2M	2 m	DC	
		BD4S-5M	5 m		
		BA4A-2M	2 m	AC	
		BA4A-5M	5 m		
	BD4A-2M	2 m	DC		
	BD4A-5M	5 m			

Suffix code





Model	Code	Content
	<input type="checkbox"/> <input type="checkbox"/> <input type="checkbox"/> <input type="checkbox"/> <input type="checkbox"/>	Cable for Connecting proximity sensor
Cable	A	Connector cable
	B	Relay cable
Operating Voltage	A	AC
	D	DC
Number of wires	2	2 wires
	3	3 wires
	4	4 wires
Connector type	S	Straight type
	A	Angle type
Cable length	2M	2 m
	5M	5 m

PHOTO SENSORS

PB series



Specifications

Model	NPN	PB-T7N	PB-T10RN	PB-T15N	PB-M3RN	PB-R01N	PB-R04RN	PB-R1N	PB-D04N
	PNP	PB-T7P	PB-T10RP	PB-T15P	PB-M3RP	PB-R01P	PB-R04RP	PB-R1P	PB-D04P
Appearance									
Sensing mode	Through-beam				Mirror reflection type	Diffuse - reflective			Distance-settable
Detecting object	Opaque object (over Ø12 mm)				Opaque object (over Ø75 mm)	White non-glossy paper (100 x 100 mm)			
Hysteresis	None					Max. 20% of sensing distance			
Operation mode	Light ON / Dark ON mode switching selection by VR								
Sensing distance	7 m	10 m	15 m	0.1 - 3 m (when using HY-M5) / 0.1 - 4 m (when using HY-M5S)		100 mm	400 mm	1 m	400 mm
Response time	Max. 1 ms								
Sensitivity adjustment	VR built-in								
Power voltage	12-24 V d.c. ±10% Ripple(p-p)10% or less								
Current consumption	Emitter	Max. 20 mA				Max. 30 mA			
	Receiver	Max. 15 mA							
Light source (wavelength)	Infrared LED (850 nm)	Red LED	Infrared LED (850 nm)	Red LED	Infrared LED (850 nm)	Red LED	Infrared LED (850 nm)		
Control output	● Load Current: max. 100mA (26.4 V d.c.) ● Residual voltage: max. 1 V								
Protection circuit	● Power reverse connection protection, ● Output reverse connection protection, ● Output short circuit protection, ● Mutual interference protection (except transmissive), ● Output short circuit notification (except floodgators)								
LED Indicator	● Red LED : operation indicator, ● Green LED : stability indicator (However, the red LED of the emitter displays the power only)								
Insulation resistance	Min. 20 MΩ (500 V d.c. mega standard)								
Dielectric strength	1,000 V a.c. (50/60 Hz for 1 min)								
Vibration resistance	10 - 55 Hz, double amplitude : 1.5 mm, X·Y·Z each direction 2 hours								
Shock resistance	500 m/s, X·Y·Z each direction 3 times								
Ambient illumination	● Sunlight : max. 11000 lx ● Incandescent lamp : max. 3000 lx								
Ambient temperature & humidity	● During operation : -20 ~ 60 °C ● During storage : -25 ~ 70 °C, 35 ~ 85 % RH (without condensation or icing)								
Noise immunity	Square wave noise by noise simulator (pulse width 1 μs) ±240 V								
Degree of protection	IP65 (IEC 60529)								
Accessories	● Bracket A, ● Bracket B(Order specification), ● Bracket C(Order specification)								
Certified									
Weight (g)	90			60		50			

Suffix code

Model	Code	Content
PB-	<input type="checkbox"/> <input type="checkbox"/> <input type="checkbox"/> <input type="checkbox"/>	General Purpose Photo Sensor
Sensing mode and distance	T 7	7 m
	T 10	10 m
	T 15	15 m
	M 3	3 m
	R 01	0.1 m
	R 04	0.4 m
	D 04	0.4 m
Light source	-	Infrared LED
	R	Red LED (Note1)
Output	N	NPN open collector output
	P	PNP open collector output

(Note1) Red light (R): T10, M3, P3, R04, only

PY series

Specifications

Model	NPN	PY-T3N
	PNP	PY-T3P
Appearance		
Sensing mode	Through - beam	
Detecting object	Opaque object (over Ø5 mm)	
Operation mode	Light ON / Dark ON mode switching selection by control wire (only receiver)	
Sensing distance	3 m	
Response time	Max. 1 ms	
Power voltage	12-24 V d.c. ± 10 %	
Current consumption	Emitter	Max. 10 mA
	Receiver	Max. 15 mA
Light source (wavelength)	Infrared LED (850 nm)	
Control output	<ul style="list-style-type: none"> ● NPN or PNP open collector output, load current - max. 100 mA (26.4 V d.c. standard), ● Residual voltage - NPN: max. 1V, PNP: max. 1V 	
Protection circuit	<ul style="list-style-type: none"> ● Power reverse protection circuit, output short circuit overcurrent protection circuit, ● Output short circuit notification circuit (Note 1), ● Output failure notification circuit (Note 2) 	
LED Indicator	<ul style="list-style-type: none"> ● Red LED : Control output, ● Green LED : stability indicator (however, the red LED of the emitter displays the power) 	
Insulation resistance	Min. 20 MΩ (500 V d.c. mega standard)	
Dielectric strength	1,000 V a.c. (50/60 Hz for 1 min)	
Vibration resistance	10 - 55 Hz, Double amplitude : 1.5 mm, X·Y·Z each direction 2 hours	
Shock resistance	500 m/s ² , X·Y·Z each direction 3 times	
Ambient illumination	<ul style="list-style-type: none"> ● Sunlight: max. 11000 lx ● Incandescent lamp: max. 3000 lx 	
Ambient temperature & humidity	<ul style="list-style-type: none"> ● During operation : -20 ~ 60 °C ● During storage : -25 ~ 70 °C, 35 ~ 85 % RH (without condensation) 	
Degree of protection	IP67 (IEC 60529)	
Materials	<ul style="list-style-type: none"> ● Case : PC ● Lens : PC 	
Connection	Cable extended type	
Weight (g)	66	

(Note 1) Repeats red LED OFF for 38.4 ms after red LED turns on for 192 μs during light-on

(Note 2) Turns OFF after red LED turns ON for 49 ms during light-on

Suffix code

Model	Code	Content
PY -	<input type="checkbox"/> <input type="checkbox"/> <input type="checkbox"/>	Flat Photo Sensor
Sensing mode	T	Through - beam
Sensing distance	3	3 m
Output	N	NPN open collector output
	P	PNP open collector output

New product
Universal

Thin

Voltage
output type

Columnar

Horseshoe

Built-in
power
Built-in
amplifier

Distance
setting type

Long
distance
Detection
type

Optical fiber



Area

Sensor
Controller

PHOTO SENSORS

PN series

Specifications

Model	PN-T3	PN-R02	PN-M1
Appearance			
Type	Through - beam	Diffuse - reflective	Retro - reflective
Sensing distance	3 m	200 mm	0.1-1 m
Detecting object	Opaque object (over Ø8 mm)	White non-glossy paper (200 x 200 mm)	Opaque object (over Ø48 mm)
Power voltage	12-24 V d.c. ±10 %		
Current consumption	Emitter	20 mA d.c.	Max. 30 mA d.c.
	Receiver	18 mA d.c.	
Operating mode	Select Light On/Dark ON by Control Line (transmission type is only for the receiver).		
Control Output	● NPN voltage output : Load voltage max. 30 V d.c., ● Load current : max. 200 mA , residual voltage : max. 1 V		
Protection circuit	Reverse polarity protection, overcurrent protection		
Response time	Max. 3 ms		
Hysteresis	-	Not more than 20% of detection distance	-
Light source (wavelength)	Infrared LED (850 nm)		
Sensitivity control	By volume for sensitivity adjustment (except for transmissive floodlights)		
Material	Case and Lens : PC		
Connection	● Cable withdrawal formula ● All competitors: 4P ● External diameter : 44 mm ● Length : 1.5 m (However, the projector is 3P)		
Ambient light	● Sunlight : max. 11000 lx, ● Incandescent light : max. 3000 lx		
Ambient temperature & humidity	● When operating : -25 to 55°C ● Storage : -40 to 70°C, 35 to 85% RH (but there will be no condensation).		
Degree of protection	IP54 (IEC 60529)		
Vibration resistance	10 - 55 Hz, Double amplitude 1.5 mm, X·Y·Z each direction for 2 hours		
Dielectric strength	1,000 V a.c. for 1 min		
Insulation resistance	20 MΩ or more (based on 500 V d.c. mega)		
Accessories	● Bracket for fixing, ● Bolt, ● Nut for fixing		
Weight (g)	250	150	100

※ The sensing distance can be varied depending on the size, surface condition, glossy, non-glossy of the sensing object





※ PN-TL3 is transmitter and PN-TR3 is receiver when it is Through-beam type

Suffix code

Model	Code	Content
PN -	<input type="checkbox"/> <input type="checkbox"/>	Photo Sensor
Sensing mode and distance	T 3	Through - beam
	M 1	Retro - reflective
	R 02	Diffuse - reflective
Operation		12-24 V d.c. ±10 %

PR series

Specifications

Model	Metal	NPN	PRM-T7RN	PRM-T10N	PRM-M2N	PRM-R01N	PRM-R04N
		PNP	PRM-T7RP	PRM-T10P	PRM-M2P	PRM-R01P	PRM-R04P
	Plastic	NPN	PRP-T7RN	PRP-T10N	PRP-M2N	PRP-R01N	PRP-R04N
		PNP	PRP-T7RP	PRP-T10P	PRP-M2P	PRP-R01P	PRP-R04P
Appearance							
Detection method	Through - beam			Retro - reflective		Diffuse - reflective	
Detection distance	7 m		10 m		0.1 ~ 2 m (※Note1)		0.1 m 0.4 m
Hysteresis distance	-			20% or less of detection distance			
Detection object	Ø 10 mm or more opaque			Ø 25 mm or more opaque		White matte paper (100x100 mm)	
Light source	RED (640nm)		IR (860nm)		IR(860nm)		
Current consumption	● Emitter : 20 mA, ● Receiver : 20 mA				30 mA 이하		
Power supply voltage	12-24 V d.c. ±10% ripple (p-p) 10% or less						
Control output	NPN or PNP open collector output ● Load current : 100 mA or less (based on 26.4 V d.c.) ● Residual voltage-NPN : 1 V or less, PNP: 1 V or less						
Operation mode	Light ON / Dark ON (by white line)						
Protection circuit	Common	● Power reverse connection protection, ● Output reverse connection protection, ● Output short circuit overcurrent protection, ● Output terminal notification (※Note2)					
	Individual	-			Mutual interference prevention function		
Response time	1 ms or less						
Insulation Resistance	20 MΩ or more (based on 500 V d.c. mega)						
Noise resistance	Square wave noise by noise simulator (pulse width 1 μs) ±240 V						
Withstand voltage	1,000 V a.c. (50/60 Hz for 1 minute)						
Vibration resistance	10-55 Hz, dust amplitude: 1.5 mm, 2 hours each in X.Y.Z directions						
Shock resistance	500 m/s ² , X·Y·Z each direction 3 times						
Ambient illuminance	● Sunlight : max. 11000 lx ● Incandescent lamp : max. 3000 lx (Light-receiving surface illuminance)						
Ambient temperature	● During operation : -20 ~ 60 °C ● During storage : -25 ~ 70 °C, 35 ~ 85 % RH (without condensation or icing)						
Ambient Humidity	35 ~ 85 % RH (with no condensation)						
Protection structure	IP66 (IEC standard)						
Acquisition standard							
Material	Case	● Metal: Gold plated, ● Plastic: Plastic					
	Display	PC					
	Lens	PC					
Accessories	common	● Metal: 2 fixing nuts, 1 washer, V/R adjustment driver ● Plastic: 2 fixing nuts, V/R adjustment screwdriver					
	Individual	-		Mirror (HY-M5)		-	
Weight	● Metal : Approx. 320 g, ● Plastic : Approx. 280 g			● Metal : Approx. 160 g, ● Plastic : Approx. 140 g			

(※ Note 1) Red light (R) : T7 only

(※ Note 2) Red LED blinks in case of overload (ON Time: 200 μs, OFF Time: 40 μs)

Suffix code

Model	Code	Content		
PR	□ - □ □ □ □ □	Round Photo Sensor		
Case material	M	Metal		
	P	Plastic		
Detection method and detection distance	T	7	7 m	Through - beam
		10	10 m	
	R	2	2 m	Retro - reflective
		01 04	0.1 m 0.4 m	Diffuse - reflective
Light source		Infrared LED		
	R	Red LED (※Note 1)		
Output	N	NPN open collector output		
	P	PNP open collector output		

(※ Note 1) Red light (R) : T7 only

New product
Universal

Thin

Voltage
output type

Columnar

Horseshoe

Built-in
power
Built-in
amplifier

Distance
setting type

Long
distance
Detection
type

Optical fiber





Area

Sensor
Controller

PHOTO SENSORS



PU series

Specifications

Model	PU-30	PU-30S	PU-50	PU-50S
Appearance				
Sensing distance	30 mm		50 mm	
Detecting object	Opaque object (over Ø2 mm)	Opaque object (over Ø0.6 mm)	Opaque object (over Ø1.5 mm)	Opaque object (over Ø0.4 mm)
Power voltage	12-24 V d.c. ±10 %			
Current consumption	Max. 30 mA			
Operating mode	Selectable Light On/Dark On for reverse polarity			
Control Output	<ul style="list-style-type: none"> ● NPN open collector output : Load voltage max. 300 V d.c., ● Load current : max. 180 mA, ● Residual voltage: max. 2 V 			
Protection circuit	Output short circuit			
Response time	Max.1 ms			
Light source (wavelength)	Infrared LED (940 nm)			
Motion Indicator	<ul style="list-style-type: none"> ● Output : Red LED, ● Power : Green LED 			
Sensitivity adjustment	fix	By volume	fix	By volume
Material	Case	Zn		
	Lens	PC		
Connection type	<ul style="list-style-type: none"> ● Cable pull-out type ● Number of wires : 3P ● Outer diameter : Ø4 mm ● Length : 2m 			
Ambient light	<ul style="list-style-type: none"> ● Sunlight : max. 11000 lx, ● Incandescent light: max. 3000 lx 			
Ambient temperature & humidity	<ul style="list-style-type: none"> ● In operation : -20 ~ 60 °C ● Storage : -25~70 °C, 35 ~ 85% RH (No condensation) 			
Degree of protection	IP65 (IEC 60529)			
Vibration resistance	10 - 55Hz, Double amplitude 1.5 mm, X·Y·Z each direction for 2 hours			
Dielectric strength	1000 V a.c. for 1 min			
Insulation resistance	Min. 20 MΩ (at 500 V d.c., between code and case, contact and power supply)			
Weight (g)	250			

PE series

Specifications

Model	PE-T5D	PE-R05D	PE-M3D
Appearance			
Detection method	Through - beam	Diffuse - reflective	Retro - reflective
Sensing distance	5 m	0.5 m	0.1 - 3 m
Detecting object	Opaque object (over 20 mm)	White non-glossy paper (200x200 mm)	Opaque object (over Ø60 mm)
Power voltage	24Vd.c., 100-240 V a.c. 50/60Hz or 100-240 V d.c. ±10 %		
Current consumption	Emitter	max. 0.7 W	Max. 2 W
	Receiver	max. 1.2 W	
Operation mode	Dark ON	Light ON	Dark ON
Control Output	Relay output 1c 250 V a.c. 2 A (resistive load)		
Response time	Max. 25 ms		
Hysteresis	-	20% or less of detection distance	-
Light source (wavelength)	Infrared LED (850 nm)		
LED Indicator	Control output indicator : Red LED (however, the through-beam emitter red LED is a power indicator)		
Sensitivity control	-	By sensitivity control volume	
Material	Case and lens : PC		
Connection	<ul style="list-style-type: none"> ● Cable pull-out type, ● Number of wires : 5P, ● Outer diameter : Ø 6 mm, ● Length : 2 m (however, 2P for transmissive emitter) 		
Ambient light	<ul style="list-style-type: none"> ● Sunlight : max. 11000 lx ● Incandescent light : max. 3000 lx 		
Ambient temperature & humidity	<ul style="list-style-type: none"> ● In operation: -20 ~ 60 °C ● Storage: -25 ~ 70 °C, 35 ~ 85% RH (No condensation) 		
Degree of protection	IP54 (IEC 60529)		
Vibration resistance	10 - 55 Hz, double amplitude width 1.5 mm, X·Y·Z, each direction for 2 hours		
Dielectric strength	1,500V a.c. for 1 min		
Insulation resistance	20MΩ or more (500 V d.c. Mega standard)		
Accessories	<ul style="list-style-type: none"> ● Bracket for fixing, ● bolt, ● Nut for fixing 		
Weight (g)	120		

PTX series

Specifications

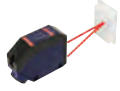
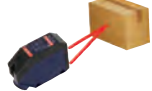
Model	Type	Normal	Timer Built-in	Normal	Timer Built-in	Normal	Timer Built-in
		Built-in Power Supply	PTX-T15A	PTX-T15A-T	PTX-M7A	PTX-M7A-T	PTX-R1A
	Built-in Amplifier	PTX-T15B	PTX-T15B-T	PTX-M7B	PTX-M7B-T	PTX-R1B	PTX-R1B-T
Appearance							
Sensing Type		Through - beam		Retro - reflective		Diffuse - reflective	
Sensing distance		15 m		7 m		1 m	
Detecting object		Opaque object (over Ø20 mm)		Opaque object (over Ø60 mm)		White non-glossy paper (200x200 mm)	
Power voltage	Built-in Power Supply	24-240 V a.c. 50/60Hz or 24-240 V d.c. ±10 %					
	Built-in Amplifier	12-24 V d.c. ± 10 %					
Current Consumption	Emitter	Built-in power : 2 W or less / Built-in amplifier : 35 mA or less		Built-in power : 2 W or less / Built-in amplifier: 45 mA or less			
	Transmitter	Built-in power : 1 W or less / Built-in amplifier : 20 mA or less					
Control Output	Built-in Power Supply	<ul style="list-style-type: none"> ● Relay contact output (contact configuration 1a, 1b (COM)), rated load life 100,000 times or more ● Contact capacity : 30 V d.c. 5A / 250 V a.c. 5A resistive load 					
	Built-in Amplifier	<ul style="list-style-type: none"> ● NPN/PNP open collector simultaneous output ● Load current : 150 mA d.c. Or less (resistive load) ● NPN current voltage : 1 V d.c. Below ● PNP current voltage : 2 V d.c. Below 					
Operation mode		Light ON/Dark ON are selectable by the selector switch					
Response time	Built-in Power Supply	Max. 20 ms					
	Built-in Amplifier	Max. 1 ms					
Hysteresis	Built-in Power Supply	-		Less than 20 % of sensing distance			
	Built-in Amplifier	-					
LED Indicator	Built-in Power Supply	● Output indication: Red LED (Transmissive type emitter has 2 red LEDs for power indication) ● Stability indication : Green LED					
	Built-in Amplifier	● Output indication : Red LED ● Stability indication : Green LED					
Sensitivity adjustment		-		Sensitivity adjusting volume built-in			
Protection circuit	Built-in Power Supply	Surge protection					
	Built-in Amplifier	Reverse polarity protection and output-circuit protection					
Timer function built-in (only corresponds to timer built-in type)		Select OFF Delay, ON Delay or One Shot Delay by using the ON/OFF switch. Delay Time: 0.1~5 sec adjust by the volume.					
Ambient illumination		● Sunlight: max. 11000 lx ● Incandescent lamp: max. 3000 lx					
Ambient temperature & humidity		● Operation temperature: -20 ~ 60 °C, ● Storage temperature: -25 ~ 70 °C, 35 ~ 85 % RH (without icing or dew condensation)					
Degree of protection		IP66 (IEC 60529)					
Insulation resistance		Min 20MΩ (standard on 500 V d.c. mega)					
Dielectric strength		1,500 V a.c. (for 1 min)					
Vibration resistance		10 - 55 Hz Double amplitude: 1.5 mm, 2 hours to each of X, Y, Z directions					
Shock resistance		500 m/s ² (approx. 50G), 3 times to each of X, Y, Z directions					
Connection method		Terminal					
Material		● Case: ABS ● Lens: PC					
Weight (g)		80					
Accessories	Individual	-		Reflector (HY-M5)		-	
	Common	● Driver, ● Bracket, ● bolt, ● Nut, ● Water-proof rubber, ● Wire holder					

※ The sensing distance may vary depending on the size, surface condition, glossy, non-glossy of the sensing object

※ The sensing distance of PTX-M7A (-T), PTX-M7B (-T) is the distance when using the reflector HY-M5

Suffix code

Model	Code	Content
PTX -	<input type="checkbox"/> <input type="checkbox"/> <input type="checkbox"/> <input type="checkbox"/>	Photo Sensor
Sensing mode and distance	T 15	Through - beam 15 m
	M 7	Retro - reflective 7 m
	R 1	Diffuse - reflective 1 m
Power voltage	A	24-240 V a.c. 50/60 Hz or 24-240 V d.c. ±10 % Built-in Power Supply
	B	12-24 V d.c. ±10 % Built-in Amplifier
Timer		Normal type
	-T	Timer Built-in type

New product Universal
Thin
Voltage output type
Columnar
Horseshoe
Built-in power Built-in amplifier
Distance setting type
Long distance Detection type
Optical fiber
Area
Sensor Controller

PHOTO SENSORS

PLD series CE

Specifications

Model	PLD-R2N	PLD-R2P
Appearance		
Sensing Type	Diffuse - reflective	
Sensing distance	2 m	
Detecting object	White non-glossy paper (200x200 mm)	
Power voltage	12-24 V d.c. ±10%	
Power consumption	Max. 30 mA d.c.	
Control output	<ul style="list-style-type: none"> ● NPN open collector Max. 150 mA d.c. (resistance load) ● Residual voltage: 1 V d.c. Below 	<ul style="list-style-type: none"> ● PNP open collector Max. 150 mA d.c. (resistance load) ● Residual voltage: 1 V d.c. Below
Operation mode	Light On mode	
Response time	Max. 1 ms	
Hysteresis	Within 20 % of detectable distance	
Light source (wavelength)	Infrared LED (850 nm)	
LED Indicator	<ul style="list-style-type: none"> ● Control output : Red LED ● Safety : green LED 	
Sensitivity adjustment	'Built-in' sensitivity adjustment V/R (220. degree spin V/R)	
Protection circuit	Reverse polarity protection, overcurrent protection	
Ambient intensity of illumination	<ul style="list-style-type: none"> ● Sunlight: max. 11000 Lux, ● Incandescent lamp: max. 3000 Lux 	
Ambient temperature & humidity	<ul style="list-style-type: none"> ● When operating: -20 ~ 60 °C , ● when maintaining: -25 ~ 70 °C, max. 35 ~ 85 % RH (without freezing) 	
Degree of protection	IP64 (IEC 60529)	
Insulating resistance	20 MΩ or more (based on 500Vd.c. mega)	
Dielectric strength	1000 V a.c. for 1 min	
Vibration resistance	10-55 Hz double amplitude 1.5mm, X,Y,Z each direction for 2 hours	
Shock resistance	500 m/s ² X·Y·Z each direction for 2 times	
Connection method	<ul style="list-style-type: none"> ● Cable pull-out typed ● Number of wires: 3P ● Outer diameter: Ø3 mm ● Length: 2 m 	
Material	<ul style="list-style-type: none"> ● Case: PET ● Lens cap: PC ● Lens : PMMA 	
Cable	3P (26 AWG), length : 2 m	
Accessories	<ul style="list-style-type: none"> ● Sensitivity adjusting driver, ● Fixing volt (3-M3 X 17L) 	
Weight (g)	60	

Suffix code

Model	Code	Content
PLD -	<input type="checkbox"/> <input type="checkbox"/> <input type="checkbox"/>	Small size photo sensors
Sensing mode	R	Diffuse - reflective
Sensing distance	2	2 m
Output	N	NPN open collector output
	P	PNP open collector output

PL-D2B

Specifications

Model	PL-D2B
Appearance	
Sensing method	Distance - settable
Sensing distance	0.2 ~ 2 m
Detecting object	White non-glossy paper (200x200 mm)
Power voltage	12-24 V d.c. ±10 %
Current consumption	Max. 30 mA
Control output	<ul style="list-style-type: none"> ● NPN / PNP open collector asynchronously, ● Load current : max. 150 mA d.c. (resistive load) ● NPN residual voltage: max. 1 V d.c., ● PNP residual voltage: max. 2 V d.c.
Operation mode	Light ON / Dark ON ※ Selectable by the mode V/R
Response time	Max. 2 ms.
Hysteresis	Less than 10% of the sensing distance
Light source (wavelength)	Infrared LED (880 nm)
Receiving part	2 Photo diodes
LED Indicator	<ul style="list-style-type: none"> ● Control out display : Red LED ● Stability display: Green LED
Distance setting	Near/Far : Optical distance adjusting volume 5 cycles.
Protection circuit	Reverse polarity protection and output short-circuit protection
Ambient illumination	<ul style="list-style-type: none"> ● Sunlight: max. 11000 lx, ● Incandescent lamp: max. 3000 lx.
Ambient temperature & humidity	<ul style="list-style-type: none"> ● Operation: -20 ~ 60 °C ● Storage: -25 ~ 70 °C, 35 ~ 85 % RH (without condensation)
Degree of protection	IP65 (IEC 60529)
Insulation resistance	Min. 20 MΩ (500 V d.c. Mega)
Dielectric strength	1,000 V a.c. (50/60 Hz for 1 min)
Vibration resistance	10 - 55 Hz, double amplitude: 1.5mm for 2 hours each in X, Y and Z directions.
Shock resistance	500 m/s ² 3 times each in X, Y and Z directions.
Connection method	<ul style="list-style-type: none"> ● Cable output type, ● Number of wires: 4P, ● Thickness: Ø 4mm ● Length 2m
Material	<ul style="list-style-type: none"> ● Case : PC, ● Lens : PC
Accessory	Bracket, Adjustable driver, bolt, Nut.

New product Universal
Thin
Voltage output type
Columnar
Horseshoe
Built-in power Built-in amplifier
Distance setting type
Long distance Detection type
Optical fiber
Area
Sensor Controller



Suffix code

Model	Code	Content
PL -	<input type="checkbox"/> <input type="checkbox"/> <input type="checkbox"/>	Distance-Settable Photo Sensor
Sensing mode	D	Distance-settable
Sensing distance	2	2 m
Power voltage	B	12-24 V d.c.

PHOTO SENSORS

PEN series

Specifications



Model		Built-in power		
		PEN-T10A	PEN-M5A	PEN-R700A
Appearance				
Sensing Type		Through - beam	Retro - reflective	Diffuse - reflective
Sensing distance		10 m	0.1 ~ 5 m	700 mm
Detecting object		Opaque object (over Ø20 mm)	Opaque object (over Ø60 mm)	White non-glossy paper (200x200 mm)
Power voltage		24-240 V a.c. 50/60Hz or 24-240 V d.c. ±10 %		
Current Consumption	Emitter	Max. 1 W	Max. 2 W	
	Transmitter	Max. 2 W		
Operation mode		Light-incident operation (Light ON) / Light-shielding operation (Dark ON) ※ Selection by mode volume		
Sensitivity adjustment		-	Built-in sensitivity adjustment volume	
Control Output		● Relay output (Contact composition 1a,1b), ● Capacity : 30 V d.c. 5 A / 250 V a.c. 5 A resistance load life expectancy - min. 100 thousand times		
Response time		Less than 20 ms		
Hysteresis		-	Within 20 % of detecting distance	
Light source (wavelength)		Infrared LED (850 nm)		
Indicator light		● Control out display : Red LED ● Stability display : Green LED (However, the red LED of the transmissive emitter is a power indicator.)		
Ambient light		● Sunlight : less than 11000 lx, ● Incandescent lamp : less than 3000 lx		
Ambient temperature		● Operation : -20 ~ 60 °C ● Storage : -25 ~ 70 °C, 35 ~ 85 % RH (without condensation)		
Degree of protection		IP 64 (IEC)		
Insulation resistance		Min. 20 MΩ. (500 V d.c. Mega)		
Dielectric strength		1,500 V a.c. (50/60 Hz for 1 min)		
Vibration resistance		10 - 55 Hz double amplitude:1.5mm for 2 hours each in X, Y and Z directions.		
Shock resistance		500 m/s ² 500m/s ² (about 50G), 3 times each in X, Y, Z directions		
Connection method		● Cable output type, ● Number of wires : 5P, ● Thickness : Ø 6mm ● Length 2m (However, the emitter is 2P)		
Material		● Case : heat-resistant ABS ● Lens : P.C		
Weight (g)		150		

Suffix code

Model	Code	Content	
PEN -	□ □ □	Photo Sensor	
Sensing mode and distance	T 10	Through - beam	10 m
	M 5	Retro - reflective	0.1 - 5 m
	R 700	Diffuse - reflective	700 mm
Power voltage	A	24-240 V a.c. 50/60 Hz or 24-240 V d.c. ±10 %	

PG series

Specifications

Model	NPN	PG-TRN	PG-TARN
	PNP	PG-TRP	PG-TARP
Appearance			
Function	Selection by switch (Normal/ON-Delay/OFF-Delay) 40 ms fixed		Selection by switch (Normal/ON-Delay/Off-Delay/One-Shot) 1 ms-5,000 ms variable
Sensing method	Through-beam type, diffuse-reflective type (decision by combined with fiber unit)		
Sensing distance	Decision by combined with fiber unit		
Power voltage	12-24 V d.c. ±10 %		
Current consumption	Max. 35 mA		
Output	Control	● NPN/PNP Voltage output ● Load voltage: max. 200 mA (30 V d.c.) ● Residual voltage : max. 1 V d.c.	
	Stability	-	● NPN/PNP Voltage output ● Load current : 50 mA (30 V d.c.) or less, ● Residual voltage : max. 1 V d.c.
Operation mode	Light ON / Dark ON switch selection operating Normal or ON/OFF delay Switch selection operating		
Response time	Max. 1 ms		
Hysteresis	Max. 10 % of sensing distance (Reflection)		
Light source (wavelength)	Red LED (630 nm)		
LED Indicator	● Control out display : Red LED ● Stability display : Green LED		
Sensitivity adjustment	Sensitivity adjustment by brewing well volume (Coarse) and fine adjustment volume (Fine)		
Protection circuit	Reverse polarity protection, overcurrent protection (except for stable output of multi-function type)		
Ambient illumination	● Sunlight : max. 11000 lx, ● Incandescent lamp : max. 3000 lx		
Ambient temperature & humidity	● Operating : -20 ~ 60 °C, ● Preserving : -25 ~ 70 °C, 35 ~ 85 % RH (without condensation)		
Degree of protection	IP40 (IEC 60529)		
Insulating resistance	Min. 20 MΩ (500 V d.c. Mega standard)		
Dielectric strength	1,000 V a.c. (50/60 Hz for 1 min)		
Vibration resistance	10 - 55 Hz double amplitude 1.5mm, X,Y,Z each direction for 2 hours		
Shock resistance	500m/s² X, Y, Z directions 3 times		
Connection method	Cable pull-out type (3 P, 2 m)		Cable pull-out type (4 P, 2 m)
Weight (g)	120		

New product Universal
Thin
Voltage output type
Columnar
Horseshoe
Built-in power Built-in amplifier
Distance setting type
Long distance Detection type
Optical fiber
Area
Sensor Controller

Suffix code

Model	Code	Content
PG -	<input type="checkbox"/> <input type="checkbox"/>	Fiber Optic Sensor
Sensing mode and distance	TR	Universal type
	TAR	Multifunctional (Built-in timer function and stable output)
Output	N	NPN open collector output
	P	PNP open collector output

PHOTO SENSORS

PFD series CE

Specifications

Model	NPN	PFD-RGN	PFD-RMN
	PNP	PFD-RGP	PFD-RMP
Appearance			
Function	Mark detection	General type (mark detection)	Multi type (mark detection, rotation speed, counter)
	Counter	-	400 cps, Up/Down, 0 - 9999
	Tachometer	-	12 ~ 9999 rpm
Power supply voltage	12-24 V d.c. ±10 %		
Current consumption	Max. 50 mA		
Output	Control	● NPN/PNP Open collector output, ● Load current: 100 mA (30 V d.c.) or less ● Residual voltage: 1V d.c. or less	
	Stability		
External input	Teaching		Teaching / Reset input
Operating mode	Selecting Light On / Dark On (selection by parameter)		
Timer function	ON-Delay, OFF-Delay, One-shot time output (Setting time: 1 ~ 9999 ms)		
On/Off Delay	0 ~ 9999 ms		
Light source (wavelength)	Red LED (660 nm)		
Protection circuit	Power reverse connection and output short protection circuit		
Response time	0.7 ms or less		1 ms or less
LED indicator	4 Digits FND		
Sensitivity control	Auto teaching/manual setting by setting button		
Additional function	● Brightness control 180° Turning indication, ● Display time set, ● Zero Reset, ● Initial reset, Lock function		
Ambient light	● Sunlight : max. 11000 lx, ● Incandescent lamp : max. 3000 lx		
Ambient temperature & humidity	● Operating : -20 ~ 60 °C, ● Preserving : -25 ~ 70 °C, 35 ~ 85 % RH (without condensation)		
Vibration resistance	10 - 55 Hz double amplitude 1.5mm, X,Y,Z each direction for 2 hours		
Shock resistance	500m/s² X, Y, Z directions 3 times		
Dielectric strength	1,000 V a.c. (50/60 Hz for 1 min)		
Insulating resistance	Min. 20 MΩ (500 V d.c. Mega standard)		
Connection method	● Cable output type, ● Number of wires: 5P, ● Thickness : Ø 4mm, ● Length 2m, ● DIN rail mounting structure		
Weight (g)	150		

● MODEL : PFD-RMN only

Multi function	Counter	● UP / DOWN Mode, ● Prescale 1 ~ 999 distribution/dispensing setting, ● Indicating range: 0 ~ 9999, ● Counting speed : 400 cps (50 % duty), ● Output mode: 8 kinds selectable (N, F, C, R, K, P, Q, A), ● External reset: Min. Signal width 5 ms
	Tachometer	● Indicating range: 0 ~ 9999 rpm, ● Speed monitoring output function, ● Prescale: 1~1000 integers setting, ● Measurement cycle setting

Suffix code

Model	Code	Content
PFD -	<input type="checkbox"/> <input type="checkbox"/> <input type="checkbox"/>	Digital optical fiber sensor
Light source	R	Red LED
Function	G	General purpose (MARK)
	M	Multi type (MARK / RPM / Counter)
External output	N	NPN open collector
	P	PNP open collector

PFB series

Specifications

Model	NPN	PFB-RN
	PNP	PFB-RP
Appearance		
Detection method	Transmissive type, reflective type (by fiber cable)	
Detection distance	By fiber cable	
Power voltage	12-24 V d.c. ±10 % (Ripple 10 %이하)	
Current consumption	Max. 20 mA	
Control output	● NPN/PNP Open collector output, ● Load current: 100 mA (30 V d.c.) or less ● Residual voltage: 1 V d.c. or less	
Output operation	Selection by light-incident (Light On) and light-shielding (Dark On) switches	
Timer function	NORMAL, ON-Delay, OFF-Delay (Delay time 40 ms fixed)	
Response time	1 ms or less	
Hysteresis	Reflective type: 10% or less of the sensing distance	
Light source (wavelength)	Red LED (660 nm)	
Indicator light	Indication by Bar LED	
Sensitivity control	Auto teaching / manual setting by setting button	
Protection circuit	Mutual interference prevention, power reverse connection and output short protection circuit	
Ambient light	● Sunlight : max. 11000 lx, ● Incandescent lamp : max. 3000 lx	
Ambient temperature	-10 ~ 55 °C (Storage ambient temperature: -25 ~ 70 °C)	
Ambient Humidity	35 ~ 85% R.H. (No condensation or freezing)	
Degree of protection	IP 40 (IEC)	
Insulation resistance	More than 20 MΩ (at 500 V d.c. between code and case, adjusting switch and case)	
Dielectric strength	1000 V a.c., 50/60 Hz for 1 min	
Vibration resistance	10 - 55 Hz double amplitude width 1.5 mm, X·Y·Z, each direction for 2 hours	
Insulation resistance	500 mΩ X, Y, Z each direction 3 times	
Connection method	● Cable output type, ● Number of wires: 5 P, ● Thickness : Ø 4 mm, ● Length 2 m, ● DIN rail mounting structure	
Material	Case: Heatproof ABS	
Weight (g)	Approx. 150 g (fixing bracket and packaging)	

New product Universal
Thin
Voltage output type
Columnar
Horseshoe
Built-in power Built-in amplifier
Distance setting type
Long distance Detection type
Optical fiber
Area
Sensor Controller

Suffix code

Model	Code	Content
PFB -	<input type="checkbox"/> <input type="checkbox"/>	10 bit A / D Built-in bar display type
Light source	R	Red LED
External output	N	NPN open collector
	P	PNP open collector

PHOTO SENSORS

PAS series CE

Specifications

Model	NPN	PAS-T4NL	PAS-T8NL	PAS-T12NL	PAS-T16NL	PAS-T20NL
	PNP	PAS-T4ND	PAS-T8ND	PAS-T12ND	PAS-T16ND	PAS-T20ND
		PAS-T4PL	PAS-T8PL	PAS-T12PL	PAS-T16PL	PAS-T20PL
		PAS-T4PD	PAS-T8PD	PAS-T12PD	PAS-T16PD	PAS-T20PD
Appearance						
Number of optical axis		4	8	12	16	20
Sensing range		60 mm	140 mm	220 mm	300 mm	380 mm
Detection distance		5 m				
Detection object		Opaque material of Ø 30 mm or more				
Optical axis pitch		20 mm				
Light source		IR (860 nm)				
Power voltage		12-24 V d.c. ±10% ripple (p-p) 10% or less				
Current Consumption		Max. 80 mA	Max. 90 mA	Max. 100 mA	Max. 110 mA	Max. 120 mA
Control output		NPN / PNP open collector output-Load current : max. 100 mA, ● Load current : 100 mA (30 V d.c.) or less ● Residual voltage : 1 V d.c. Below				
Operating mode		Light ON or Dark ON				
LED Indicator		● Emitter : Power indicator (green LED), M/S indicator (red LED) ● Receiver : Incoming light stability indicator (green LED), output indicator (red LED), E1 indicator (red LED), E2 indicator (blue LED)				
Protection circuit		● Power reverse connection protection, ● Output short circuit overcurrent protection, ● Mutual interference prevention function				
Response time		7 ms or less				
Insulation Resistance		20 MΩ or more (based on 500 VDC mega)				
Noise resistance		Square wave noise by noise simulator (pulse width 1μs) ± 240 V				
Dielectric strength		1,000 V a.c. (50/60 Hz for 1 min)				
Vibration resistance		10 - 55 Hz double amplitude width 1.5 mm , X·Y·Z, each direction for 2 hours				
Shock resistance		500 m/s ² , X·Y·Z each direction 3 times				
Ambient light		● Sunlight : max. 11000 lx, ● Incandescent lamp : max. 3000 lx				
Ambient temperature		● Operating : -10 ~ +55 °C, ● Preserving : -25 ~ +70 °C (However, no freezing or condensation)				
Ambient humidity		35 ~ 85 % RH (However, no condensation)				
Degree of protection		IP40 (IEC standard)				
Acquisition standard		CE				
Connection method		When taking out the cable (Number of wires : 5 P, Length : 3 m, Outer diameter : Ø 4 mm)				
Material	Case	ABS				
	Display	Acryl				
	Lens	Acryl				
Weight (g)		160	180	200	220	240

Suffix code

Model	Code	Content
PAS -	<input type="checkbox"/> <input type="checkbox"/> <input type="checkbox"/> <input type="checkbox"/> <input type="checkbox"/>	Area Sensor slim type
Optical axis spacing	20	20 mm
Sensing mode	T	Through - beam
Number of optical axis	4	4 optical axis
	8	8 optical axis
	12	12 optical axis
	16	16 optical axis
	20	20 optical axis
Control output	N	NPN open collector
	P	PNP open collector
Operation mode	L	Light ON
	D	Dark ON

PAN series CE

Specifications

Model	NPN	PAN20-T□N	PAN40-T□N
	PNP	PAN20-T□P	PAN40-T□P
Appearance			
Sensing type	Through - beam		
Sensing distance	7 m		
Detecting object	Opaque object (over $\varnothing 32$ mm)		Opaque object (over $\varnothing 52$ mm)
Optical axis pitch	20 mm		40 mm
Power voltage	12-24 V d.c. $\pm 10\%$ ripple (p-p) 10% or less		
Current Consumption	Max. 170 mA		Max. 100 mA
Control output	NPN or PNP open collector output, ● Load current : 100 mA (26.4 VDC standard) or less ● Residual voltage : 1 V d.c. Below		
Operation mode	● Emitter : M/S mode switch switching type (Master / Slave) ● Receiver : D/L mode switch switching type (Dark ON, Light ON)		
Operation indicator	● Emitter : Power indicator (green LED), M/S indicator (red LED) ● Receiver : Incoming light stability indicator (green LED), output indicator (red LED), E1 indicator (red LED), E2 indicator (blue LED)		
Protection circuit	● Power reverse connection protection, ● Output short circuit overcurrent protection, ● Mutual interference prevention function		
Response time	Max. 15 ms		
Insulation Resistance	20 M Ω or more (based on 500 VDC mega)		
Noise resistance	Square wave noise by noise simulator (pulse width 1 μ s) \pm 240 V		
Dielectric strength	1,000 V a.c. (50/60 Hz for 1 min)		
Vibration resistance	10 - 55 Hz double amplitude width 1.5 mm , X·Y·Z, each direction for 2 hours		
Shock resistance	500 m/s ² , X·Y·Z each direction 3 times		
Ambient light	● Sunlight : max. 11000 lx, ● Incandescent lamp : max. 3000 lx(receiving surface illuminance)		
Ambient temperature	● Operating : -10 ~ +55 $^{\circ}$ C, ● Preserving : -25 ~ +70 $^{\circ}$ C (However, no freezing or condensation)		
Ambient humidity	35 ~ 85 % RH (However, no condensation)		
Degree of protection	IP65 (IEC standard)		
Acquisition standard	CE		
Connection method	When taking out the cable (Number of wires : 4 P, Length : 200 mm, Outer diameter : \varnothing 5.5 mm)		
Material	Case	Aluminum	
	Front cover	Acryl	
	Lens	Acryl	

New product Universal
Thin
Voltage output type
Columnar
Horseshoe
Built-in power Built-in amplifier
Distance setting type
Long distance Detection type
Optical fiber
Area
Sensor Controller

Suffix code

Model	Code	Content
PAN	□ -□ □ □	Area Sensor
Optical axis pitch	20	20 mm spacing
	40	40 mm spacing
Sensing method	T	Through - beam
Number of optical axis		Number of optical axis (please refer to the dimension)
Output	N	NPN open collector
	P	PNP open collector

Suffix code

PAN 20	8, 12, 16, 20, 24, 28, 32, 36, 40, 44, 48
PAN 40	4, 6, 8, 10, 12, 14, 16, 18, 20, 22, 24

AREA SENSORS

HPAN series CE

Specifications

Model	HPAN-C7	HPAN-CT7	HPAN-C7W
Appearance			
WXHxD(mm)	38.5×82.1×80.8		
Function	Universal	High function	Two sensors connectable
How to attach	DIN Rail		
Power Voltage	110 - 220 V a.c., 50/60 Hz, ±10 %		
Power consumption	Approx. 5 VA		
Power supply to sensor	12 V d.c. (±10 %), Load current: 200 mA or less		
Input	<ul style="list-style-type: none"> ● [L] Level 0-2 V d.c., Internal pull-up/pull-down resistance connection by NPN/PNP switch setting (4.7 kΩ), ● [H] Level 4-30 V d.c., ● NORM/INV input signal inversion function 		
Output	Contact point	<ul style="list-style-type: none"> ● NO contact : 250 V a.c. 3 A resistance load ● NC contact : 250 V a.c. 2 A resistance load ● Relay rated load life : 100,000 times 	
	Contactless	<ul style="list-style-type: none"> ● NPN open collector output, load current : 100 mA (30 V d.c.) or less ● Residual voltage : 1VDC or less, ISOLATION (insulation from internal circuit) 	-
Response time	<ul style="list-style-type: none"> ● Relay contact : approx. 10 ms, ● NPN open collector : max. 5 μs 		
External synchronization	IN, ES period synchronization output function	IN, ES period synchronization and differential synchronization output function	-
Timer function	-	<ul style="list-style-type: none"> ● 3 types of timer setting modes (ON DELAY, OFF DELAY, ONE SHOT DELAY) ● Timer time can be set (selected by dip switch) 40 ms~1 sec ↔ 0.4 s~10 sec 	-
Ambient temperature & humidity	<ul style="list-style-type: none"> ● Operating : -20 ~ 60 °C, ● Preserving : -25 ~ 70 °C, 35 ~ 85 % RH (without condensation) 		
Noise immunity	Power line : 2000 VP, 0.5 μs pulse width (by noise simulation)		
Dielectric strength	1,500 V a.c. 1 minute at 60 Hz		
Insulation resistance	20 MΩ (based on 500Vd.c. mega)		
Vibration resistance	10-55 Hz (cycle 1 minute), double amplitude: 1.5 mm, 2 hours in each of X, Y, and Z directions (however, power is not turned on)		
Shock resistance	100m℘ X, Y, Z directions twice each (however, the power is not turned on)		
Weight (g)	160		



HPA-12

Specifications

Model	HPA-12
Appearance	
WXHxD(mm)	49.0×61.0×90.0
Function	Multi-purpose
How to attach	Relay Socket 8PIN
Power Voltage	220 V a.c. ±10 % 60 Hz
Power consumption	Approx. 4 VA
External output power	12 V d.c. ±10%, Load current: 50 mA or less
Connectable sensor (Input)	NPN, PNP Transistor output sensor
Output	Relay contact : 1 c (250 V a.c. 3 A, resistive load, rated load life: 100,000 times)
Response time	Approx. 10 ms
Ambient temperature & humidity	<ul style="list-style-type: none"> ● Operating : -20 ~ 60 °C, ● Preserving : -25 ~ 70 °C, 35 ~ 85 % RH (without condensation)
Noise immunity	<ul style="list-style-type: none"> ● Power line: 1,500 Vp ● Pulse width: 0.5 μs (noise simulator)
Dielectric strength	1500 V a.c. for 1 min (between supply and output)
Insulation resistance	20 MΩ (based on 500Vd.c. mega)
Vibration resistance	10 - 55 Hz (for a minute), double amplitude width 1.5 mm, each X·Y·Z direction for 2 hour (in power off)
Shock resistance	100 m℘ (Approx. 10 G), each X·Y·Z, 2 direction (in power off)
Weight (g)	260

HE30B, HE40B, HE50B series CE

Specifications

Model		HE30B	HE40B	HE50B	
Appearance					
Electrical specifications	Output phase difference	Phase difference between the phase A and B : T/4 ± T/8 (1 cycle of A phase=T)			
	Response speed	Max. 200 kHz			
	Rated voltage	NPN voltage output	※ Depending on the model name composition		
		Open collector	5-12 V d.c. ±5 %		
		Totem pole output	12-24 V d.c. ±5 %		
		Line driver output	5 V d.c. ±5 %	5 V d.c. / 12 V d.c. / 24 V d.c. ±5 %	
	Current consumption	Max. 60 mA (no load)			
	Connection method	Cable extended type			
	Control output	NPN voltage output	● Load current : max. 30 mA ● Load current : 30 mA or less, ● Residual voltage : 0.4 V or less		
		NPN open collector			
		Totem pole output	LOW (load current : max. 30 mA, residual voltage : max. 0.4 V d.c.) HIGH (load current : max. 10 mA, output voltage : above rated voltage -2.5 V)		
		Line driver output	LOW (load current : max. 20 mA, residual voltage: max. 0.4 V) HIGH (load current : max. 20 mA, residual voltage: min. 2.5 V)		
	Response time	Voltage output	Max. 1 μs (wire length : 1.5 m, sinking current= max. 30 mA)		
		Open collector			
Totem pole output		Max. 1 μs (wire length : 1.5 m, sinking current= max. 10 mA)			
Line driver output		Max. 1 μs (wire length : 1.5 m, sinking current= max. 30 mA)			
Mechanical specifications	Starting torque	2×10 ⁻³ N·m	4×10 ⁻³ N·m	7×10 ⁻³ N·m	
	Moment of inertia	Max 2 × 10 ⁻⁶ kg·m ²	Max 4 × 10 ⁻⁶ kg·m ²	Max 8 × 10 ⁻⁶ kg·m ²	
	Permissible shaft loading	● Radial : within 15 N	● Radial : within 30 N	● Radial : within 50 N	
		● Thrust : within 10 N	● Thrust : within 20 N	● Thrust : within 30 N	
	Max. number of revolutions	5,000 r/min			
Ambient specifications	Insulation resistance	Min. 100 MΩ (between the terminal and case 500 V d.c. mega standard)			
	Dielectric strength	800 V a.c. 60 Hz for 1 min (between the terminal and case)			
	Vibration resistance	10 - 55 Hz (cycle for 1 min), double amplitude : 1.5 mm, for 2 hours each in X, Y and Z directions			
	Shock resistance	Max. 490 m/s ²	Max. 735 m/s ²		
	Ambient temperature & humidity	-10 ~ 70 °C, 35 ~ 85 % RH (without condensation), during storage: -25 ~ 85 °C			
	Cable	● 5P, Ø5.0 mm, length : 1.5 m, shield cable (HE40B, HE50B specifications : 2m, 8m, 10 m) ● Line driver type : 8P, Ø5.0 mm, length : 1.5 m, shield cable			
	Accessories	Ø 4.0 mm coupling	Ø 6.0 mm / Ø 8.0 mm coupling	Ø 8.0 mm coupling, bracket	
Weight (g)	120	170	200		

Axial
Hollow shaft type
Clogged hollow Axial
Wheel type

Suffix code

Model	Code	Content		
HE	□ - □ □ □ □ □ □	Shaft Rotary Encoder (incremental)		
Dimension	30B 4	Outer diameter : Ø 30 mm axis : Ø 4 mm		
	40B	6	Outer diameter : Ø 40 mm axis : Ø 6 mm	
		8	Outer diameter : Ø 40 mm axis : Ø 8 mm Option : (Option)	
	50B	8	Outer diameter : Ø 50 mm axis : Ø 8 mm	
Number of pulses	*	Refer to "Number of pulses (resolution)"		
Output signal	2	A, B phase output		
	3	A, B, Z phase output		
	3C	A, B, Z̄ phase output		
	4	A, Ā, B, B̄ phase output		
	6		A, Ā, B, B̄, Z, Z̄ phase output	
Output circuit	N	12	NPN voltage output (5 - 12 V d.c.)	
		24	NPN voltage output (12-24 V d.c.)	
	O	12	NPN open collector output (5 - 12 V d.c.)	
		24	NPN open collector output (12-24 V d.c.)	
	T	12	Totem pole output (5 - 12 V d.c.)	
		24	Totem pole output (12-24 V d.c.)	
	L	5	Line driver Output (5 V d.c.)	
		12		Line driver Output (12 V d.c.)
				Line driver Output (24 V d.c.)
		24	Line driver Output (24 V d.c.)	

Number of pulses (resolution)

Model	Number of pulses per revolution
HE30B	100, 200, 360, 500, 1000, 1024
HE40B / HE50B	*1, *2, *5, 10, *12, 15, 20, 25, 30, 40, 45, 50, 60, 75, 100, 120, 125, 150, 192, 200, 240, 250, 256, 300, 360, 400, 500, 512, 600, 800, 1000, 1024

(Note) *_j Is output only for A, B phase (line driver output: A, Ā, B, B̄ phase).
Pulses other than the ones in the chart are order-made

※ Please contact us if you have any request for pulse production

ROTARY ENCODERS

HE40H series

Specifications

Model		HE40H	
Appearance			
Electrical specifications	Output phase difference	Phase difference between the phase A and B : $T/4 \pm T/8$ (1 cycle of A phase=T)	
	Response speed	200 KHz max.	
	Rated voltage	NPN voltage output	※ Depending on the model name composition
		Open collector	5-12 V d.c. $\pm 5\%$
		Totem pole output	12-24 V d.c. $\pm 5\%$
		Line driver output	5 V d.c. $\pm 5\%$
	Current consumption	Max. 60 mA (no load), line driver output max. 50 mA (no load)	
	Connection method	Cable extended type	
	Control output	NPN voltage output	● Load voltage : max. 30 V, ● Load current : max. 30 mA, ● Residual voltage : max. 0.4 V
		NPN open collector	
		Totem pole output	LOW (load current: max. 30 mA, residual voltage: max. 0.4 V) HIGH (load current : max. 10 mA, output voltage: above rated voltage - 2.5 V)
		Line driver output	LOW (load current: max. 20 mA, max. 0.4 V) HIGH (load current : max. 20 mA, residual voltage: min. 2.5V)
	Response time	Voltage output	Max. 1 μ s (wire length: 1.5 m, sinking current= 30 mA)
		Open collector	
Totem pole output		Max. 1 μ s (wire length: 1.5 m, sinking current= max. 10 mA.)	
Line driver output		Max. 1 μ s (wire length: 1.5 m, sinking current= max. 30 mA)	
Mechanical specifications	Starting torque	4×10^{-3} N.m	
	Moment of inertia	4×10^{-6} g·cm ² max	
	Permissible shaft loading	● Radial : within 30 N ● Thrust : within 20 N	
	Max. number of revolutions	5,000 r/min	
Ambient specifications	Insulation resistance	Min. 100 M Ω (between the terminal and case 500 V d.c. mega standard)	
	Dielectric strength	800 V a.c. 60 Hz for 1 min (between the terminal and case)	
	Vibration resistance	10 - 55 Hz (cycle for 1 min), double amplitude : 1.5 mm, for 2 hours each in X, Y and Z directions	
	Shock resistance	490 m/s ² max	
	Ambient temperature & humidity	-10 ~ 70 °C (without icing), during storage: -25 ~ 85 °C, 35 ~ 85 % RH	
	Cable	● 5 P, $\varnothing 5.0$ mm, length : 1.5 m, shield cable (HE40H cable length option : 2 m, 8 m, 10 m) ● Line drive type : 8P, $\varnothing 5.0$ mm, length : 1.5 m, shield cable	
Weight (g)	170		

Suffix code

Model	Code	Content		
HE	<input type="checkbox"/> - <input type="checkbox"/> <input type="checkbox"/> <input type="checkbox"/> <input type="checkbox"/> <input type="checkbox"/>	Hollow Shaft Rotary Encoder (incremental)		
Dimension	40H	6	Outer diameter : $\varnothing 40$ mm axis inner diameter : $\varnothing 6$ mm	
		8	Outer diameter : $\varnothing 40$ mm axis inner diameter : $\varnothing 8$ mm	
		10	Outer diameter : $\varnothing 40$ mm axis inner diameter : $\varnothing 10$ mm	
		12	Outer diameter : $\varnothing 40$ mm axis inner diameter : $\varnothing 12$ mm	
Number of pulse	*	Refer to the pulse code chart (resolving power)		
Output signal (output phase)		2	A, B phase output	
		3	A, B, Z phase output	
		3C	A, B, \bar{Z} phase output	
		4	A, \bar{A} , B, \bar{B} phase output	
		6	A, \bar{A} , B, \bar{B} , Z, \bar{Z} phase output	
Output circuit		N	12	NPN voltage output (5 - 12 V d.c.)
			24	NPN voltage output (12-24 V d.c.)
		O	12	NPN open collector output (5 - 12 V d.c.)
			24	NPN open collector output (12-24 V d.c.)
		T	12	Totem pole output (5 - 12 V d.c.)
			24	Totem pole output (12-24 V d.c.)
L	Line driver output (5 V d.c.)			

Number of pulses (resolution)

Model	Number of pulses per revolution
HE40H	*1, *2, *5, 10, *12, 15, 20, 25, 30, 40, 45, 50, 60, 75, 100, 120, 125, 150, 192, 200, 240, 250, 256, 300, 360, 400, 500, 512, 600, 800, 1000, 1024,

(Note) F*₁ is output only for A, B phase (line driver output: A, \bar{A} , B, \bar{B} phase).
Pulses other than the ones in the chart are order-made

※ Please contact us if you have any request for pulse production

HE40HB series

Specifications

Model		HE40HB		
Appearance				
Electrical specifications	Output phase difference		Phase difference between the phase A and B : T/4 ± T/8 (1 cycle of A phase=T)	
	Response speed		Max. 200 kHz	
	Rated voltage	NPN voltage output	※ By suffix code	
		Open collector	5-12 V d.c. ±5 %	
		Totem pole output	12-24 V d.c. ±5 %	
		Line driver output	5 / 12 / 24 V d.c. ±5 %	
	Current consumption		Max. 60 mA, line driver output max. 30 mA (no load)	
	Connection		Cable extended type	
	Control output	NPN voltage output	● Load voltage : max. 30 V ● Load current: max. 30 mA ● Residual voltage : max. 0.4 V	
		NPN open collector		
		Totem pole output	● LOW (load current: max. 30mA residual voltage: max. 0.4V) ● HIGH (load current: max. 10mA, output voltage: above rated voltage - 2.5 V d.c.)	
		Line driver output	● LOW (load current: max. 20 mA, residual voltage: max. 0.4 V d.c.) ● HIGH (load current: max. 20 mA, residual voltage: min. 2.5V d.c.)	
	Response time	Voltage output	Max. 1 μs (wire length: 1.5 m, sinking current= max. 30 mA)	
		Open collector	Max. 1 μs (wire length: 1.5 m, sinking current= max. 10 mA.)	
Totem pole output		Max. 1 μs (wire length: 1.5 m, sinking current= max. 30 mA)		
Line driver output		Max. 1 μs (wire length: 1.5 m, sinking current= max. 30 mA)		
Mechanical specifications	Starting torque		4×10 ⁻³ N.m	
	Moment of inertia		4×10 ⁻⁶ Kg·m ² max	
	Permissible shaft loading		● Radial : within 30 N ● Thrust : within 20 N	
	Max. number of revolutions		5,000 r/min	
Ambient specification	Insulation resistance		Min. 100 MΩ (between the terminal and case 500 V d.c. mega standard)	
	Dielectric strength		800 V a.c. 60 Hz for 1 min (between the terminal and case)	
	Vibration resistance		10 - 55 Hz (cycle for 1 min), double amplitude : 1.5 mm, for 2 hours each in X, Y and Z directions	
	Shock resistance		Max. 735 m/s ²	
	Ambient temperature & humidity		-10 ~ 70 °C (without condensation), during storage : -25 ~ 85 °C, 35 ~ 85 % RH	
	Cable		● 5 P, Ø 5 mm, length : 1.5 m, shield cable ● Line driver type : 8P, Ø 5 mm, length : 1.5 m, shield cable	
	Accessories		Bracket	

Axial
Hollow shaft type
Clogged hollow Axial
Wheel type

Suffix code

Model	Code						Content
HE	□-	□	□	□	□	□	Blind Shaft Type Rotary Encoder (Incremental)
Dimension	40HB	6					Outer diameter : Ø40 mm inner diameter : Ø6 mm
		8					Outer diameter : Ø40 mm inner diameter : Ø8 mm
		10					Outer diameter : Ø40 mm inner diameter : Ø10 mm
		12					Outer diameter : Ø40 mm inner diameter : Ø12 mm
Number of pulses		*				Refer to "Number of pulses (resolution)"	
Output signal (Output phase)			2				A, B phase output
			3				A, B, Z phase output
			3C				A, B, Z̄ phase output
			4				A, Ā, B, B̄ phase output
			6				A, Ā, B, B̄, Z, Z̄ phase output
	Output circuit	N	24				
				NPN voltage output (5 - 12 V d.c.)			
12							NPN open collector output (12-24 V d.c.)
							NPN open collector output (5 - 12 V d.c.)
T		24					Totem pole output (12-24 V d.c.)
							Totem pole output (5 - 12 V d.c.)
L		5					Line driver Output (5 V d.c.)
							Line driver Output (12 V d.c.)
		12					Line driver Output (24 V d.c.)
							Line driver Output (24 V d.c.)

Number of pulses (resolution)

Model	Number of pulses per revolution
HE40HB	*1, *2, *5, 10, *12, 15, 20, 25, 30, 40, 45, 50, 60, 75, 100, 120, 125, 150, 192, 200, 240, 250, 256, 300, 360, 400, 500, 512, 600, 800, 1000, 1024

(Note) * is output only for A, B phase (line driver output: A, Ā, B, B̄ phase). Pulses other than the ones in the chart are order-made

※ Please contact us if you have any request for pulse production

ROTARY ENCODERS

PSC series CE

Specifications

Model		PSC	
Appearance			
Electrical specifications	Output phase difference	Phase difference between the phase A and B : $T/4 \pm T/8$ (1 cycle of A phase=T)	
	Response speed	Max. 100 KHz	
	Rated voltage	5-12 V d.c. ($\pm 5\%$), 12-24 V d.c. ($\pm 5\%$)	
	Current consumption	Max. 60 mA	
	Connection	Cable extended type	
	Control output	Voltage and open collector outputs	● Load voltage: max. 30 V, ● load current: max. 30 mA, ● Residual voltage: max. 0.4 V
		Totem pole output	● LOW (load current : max. 30 mA, residual voltage : max. 0.4 V) ● HIGH (load current : max. 10 mA, output voltage : above rated voltage - 1.5 V d.c.)
Response time	Max. 1 μ s (wire length: 1.5 m, sinking current= 30 mA)		
Mechanical specifications	Starting torque	Max. 200 gf·cm (19,600 u N·m)	
	Moment of inertia	Max. 800 g·cm ² (8×10^{-6} kg·m ²)	
	Permissible shaft loading	● Radial : within 0.1 mm, ● Thrust : within 0.2 mm	
	Max. number of revolutions	5,000 r/min	
	Bearing life	1.2×10^7 / (r/min) : time	
Ambient specification	Insulation resistance	Min. 500 M Ω (between the terminal and case)	
	Dielectric strength	500 V a.c. 60 Hz for 1 min (between the terminal and case)	
	Vibration resistance	10 - 55 Hz (cycle for 1 min), double amplitude : 1.5 mm, for 2 hours each in X, Y and Z directions	
	Shock resistance	Max. 75 G	
	Ambient temperature & humidity	-10 ~ 70 °C (without icing), during storage: -25 ~ 85 °C, 35 ~ 85 % RH	
	Cable	● Number of strips: 5 P, ● thickness: \varnothing 5.0 mm, ● Length: 1.5 m, ● Shield cable	
	Weight (g)	625	

Suffix code

Model	Code	Content
PSC-	<input type="checkbox"/> <input type="checkbox"/> <input type="checkbox"/> <input type="checkbox"/>	Wheel Type Encoder
Min. length measurement	MA	1 m
	MB	1 cm
	MC	1 mm
	YA	1 YARD
	YB	0.1 YARD
	YC	0.01 YARD
Output signal	AB	A, B phase output (PSC-MA, YA), the others are A, B, Z Phase output
Output circuit	N	NPN voltage output
	O	NPN open collector
	T	Totem pole output
Power voltage	12	12 V d.c. (5-12 V d.c.)
	24	24 V d.c. (12-24 V d.c.)

※ The codes PSC-MA and PSC-YA are A, B phase output. The others are A, B, Z phase output

TPR-3

Specifications

Model	TPR-3P	
Appearance		
Power voltage	220 V a.c. / 380 V a.c. / 440 V a.c.	
Power frequency	50/60 Hz (common)	
Rated current	200 A / 250 A / 320 A / 500 A	
Protective circuit	● Fuse break alarm, ● Over current alarm, ● Overheating heat sink	
Applying load	Resistive load / Inductive load	
Control input	Current Input	4~20 mA d.c.
	Voltage Input	1~5 V d.c.
	Contact Input	ON/OFF
	External VR	External volume (10 kΩ)
Control type	● Phase control, ● ON/OFF control	
Start type	Soft start / down	
Output voltage	More than 95 % of the Power voltage (In case of maximum current input)	
Cooling type	Forced cooling (200 A ~ 500 A), separate power supply for fan driving (320 A, 500 A)	
Display method	Display by LED light	
Insulation resistance	Min. 100 MΩ (Base on 500 V d.c. mega)	
Output adjustable range	0 ~ 100 %	
Dielectric strength	2,000 V a.c. 50/60 Hz for 1 min	
Line noise	Noise by noise simulator (2 kV)	
Ambient temperature & humidity	0 ~ 40 °C, 35 ~ 85 % RH (without condensation)	
Storage temperature	-25 ~ 70 °C	
Weight (g)	200/250 A: about 15 kg, 320 A: about 22 kg, 500 A: about 35 kg	

General type
3-phase

New product
General single
phase

MINI
Slim type
Single-phase,
three-phase

Slim type
phase

3 channels
Each phase
control

Slim type
3-phase

Suffix code





Model	Code	Content
TPR-3P	<input type="checkbox"/> <input type="checkbox"/>	3-Phase Power Regulator
Power voltage	220	220 V a.c.
	380/440	380 V a.c. / 440 V a.c.
Rated current	200	200 A
	250	250 A
	320	320 A
	500	500 A

THYRISTOR POWER REGULATORS

TPR-2G

NEW

Specifications

Model	Low voltage	TPR-2G25L	TPR-2G35L	TPR-2G50L	TPR-2G70L
	High voltage	TPR-2G25H	TPR-2G35H	TPR-2G50H	TPR-2G70H
Appearance					
Power voltage	Low voltage	220 V a.c.			
	High voltage	380 V a.c.			
Power frequency		50 Hz / 60 Hz (common)			
Rated current (40 °C standard)		25 A	35 A	50 A	70 A
Applying load		Resistive load			
Control Input	Current input	4-20 mA d.c. (impedance : 100Ω)			
	Voltage input	-		1-5 V d.c.	
	Contact input	ON / OFF		-	
	External VR	External volume (10 kΩ)			
Control method		● Phase control (shipment mode), ● Fixed cycle cycle control (optional), ● Variable cycle cycle control (optional)			
Movement type		SOFT START / SOFT DOWN (Time 0 to 50 seconds)			
Output voltage		More than 98 % of the Power voltage (In case of maximum current input)			
Cooling method		Natural cooling			Forced cooling
Display method		Display by LED			
Insulation resistance		500 V d.c. 100 MΩ			
Dielectric strength		2,500 V a.c. 50/60 Hz for 1 min			
Line noise		Noise by noise simulator (Pulse width 1 us: ± 2kV)			
Ambient temperature		0~50 °C (However, no condensation)			
Ambient Humidity		30 ~ 85 % RH			
Storage temperature		-25 ~ 70 °C			
Weight(g)		740		1,730	1,750

Suffix code

Model	Code			Content
TPR-2G	<input type="checkbox"/>	<input type="checkbox"/>	<input type="checkbox"/>	Single-phase power regulator
Rated current	25			25 A
	35			35 A
	50			50 A
	70			70 A
Used load voltage	L			220 V a.c. 50/60 Hz
	H			380 V a.c. 50/60 Hz
Control method	-			Phase Control (Default MODE)
	F			Fixed Cycle Control(Optional)
	V			Variable Cycle Control(Optional)

TPR-2M

Specifications

Model		Economical type	Advanced type	
		Low voltage	Low voltage	High voltage
		TPR-2ME25L	TPR-2MS25L	TPR-2MS25H
		TPR-2ME35L	TPR-2MS35L	TPR-2MS35H
Appearance				
WXHxD (mm)		47.5×90.0×112.0		
Load Voltage		100-240 V a.c.		100 - 440 V a.c.
Circuit input power		100-240 V a.c. 3 W		24 V d.c. 1 W
Power frequency		50/60 Hz (common)		
Rated current		25 A / 35 A		
Control Input	Current input	4-20 mA d.c. (impedance : 100 Ω) (Basic packages)	4-20 mA d.c. (impedance : 100 Ω) (Option)	
	Voltage input	1-5 V d.c. (Basic packages)	1-5 V d.c. (Option)	
	Contact input	ON/OFF (Basic packages)	ON/OFF (Option)	
	External VR	External VR (10 kΩ) Simultaneous use of current and voltage input is not supported	-	
Applicable device		TRIAC		SCR
Control method		● Phase control (Basic), ● Variable Cycle control (Option)		
Movement type		SOFT START (60 sec), SOFT UP/DOWN (15 sec) / Adjust start time by SOFT VR		
Output voltage		More than 98 % of the Power voltage (In case of maximum current input) / Output limitation control by Power VR		
Alarm function		-	● Relay contact output (overcurrent (CE), ● heat sink overheat (OT), ● power failure/heater break (PE), ● SCR short (PE)	
Display method (LED)	Check Output Volume	FIRE : Flicker speed directly proportional to output		
	Check power	POWER: ON POWER	-	
	Alarm verification	-	CE (CURRENT ERROR) : Load current greater than 45 A	
		-	OT (OVER TEMP) : Heat shield temperature above 85°C	
		PE (power ERROR): Power error, Heater break		
Cooling method		Natural cooling		
Weight (g)		322		

General type 3-phase
New product General single phase
MINI Slim type Single-phase, three-phase
Slim type phase
3 channels Each phase control
Slim type 3-phase

Suffix code

Model	Code	Content
TPR-2M	<input type="checkbox"/> <input type="checkbox"/> <input type="checkbox"/> <input type="checkbox"/>	Single-Phase Mini Power Controller
Type	E	Economical type
	S	High function
Rated current	25	25 A
	35	35 A
Power voltage	L	100-240 V a.c.
	H	100 - 440 V a.c. (High function only)
Selection specification (High function only)	C	4-20 mA d.c.
	V	1-5 V d.c.
	O	ON/OFF
		Economic type: Basic specification High function: Selection specification (optional 1)

※ The circuit input voltage shall be applied separately. (Low pressure : 100-240 V a.c. / High pressure: 24 V d.c.)

THYRISTOR POWER REGULATORS

TPR-3M

Specifications

Model	TPR-3M25L	TPR-3M45L
Appearance		
WXHxD (mm)	110.0×157.5×150.0	
Power Voltage	100-240 V a.c.	
Circuit input power	24 V d.c. 8 W	
Frequency of use	50/60 Hz	
rated current	25 A	45 A
Applied Load	Resistance load	
Control Input	4-20 mA d.c. (impedance: 100 Ω)	
Control method	Phase control (select variable cycle, fixed cycle control options)	
Output voltage	More than 98 % of the Power voltage (In case of maximum current input) / Output limitation control by Power VR	
Cooling method	Forced cooling (24 V d.c. FAN)	
Display method	4 LEDs display status and alarm conditions	
Insulation resistance	Above 100 ((based on 500 Vd.c. mega)	
Voltage withstand	2,500Va.c. 50/60 Hz For 1 min	
Line noise	Noise by noise simulator (2,000 V)	
Storage temperature	-30 ~ 90 °C	
Ambient temperature & humidity	-20 ~ 80 °C, 45 ~ 85% RH (No condensation)	
Weight (g)	1,756	

Suffix code

Model	Code	Content
TPR-3M	<input type="checkbox"/> <input type="checkbox"/> <input type="checkbox"/>	3-Phase mini power regulator
Rated current	25	25 A
	45	45 A
Power Voltage	L	100-240 V a.c. (For low voltage)
Option	IS	Power insulation type

※ Option -IS type is a product that can connect up to 5 in series with 1 temperature controller and power supply (SMPS).
The general type is 24 V d.c. The partial power circuit is non-insulated and requires 1:1 connection with the temperature controller.

TPR-2SL

Specifications

Model	Low voltage	TPR-2SL 040L	TPR-2SL 055L	TPR-2SL 070L	TPR-2SL 090L	TPR-2SL 110L	TPR-2SL 130L	TPR-2SL 160L	TPR-2SL 200L
	High voltage	TPR-2SL 040H	TPR-2SL 055H	TPR-2SL 070H	TPR-2SL 090H	TPR-2SL 110H	TPR-2SL 130H	TPR-2SL 160H	TPR-2SL 200H
Appearance									
WXHxD (mm)	60.0×183.0×172.1		60.0×203.0×172.1		85.0×219.0×205.1		85.0×245.5×205.1		
Power voltage	Low voltage	100-240 V a.c.							
	High voltage	380-440 V a.c.							
Circuit input power	6 W			16 W			20 W		
	100-240 V a.c.								
Power frequency	50/60 Hz (Common)								
Rated current (40 °C standard)	40 A	55 A	70 A	90 A	110 A	130 A	160 A	200 A	
Fuse installation	None (optional)				Built-in fast acting fuse				
Applying load	Resistive load								
Control Input	Current input	4-20 mA d.c. (impedance : 100 Ω)							
	Voltage input	1-5 V d.c. (option : 0-10 V d.c.)							
	Contact input	ON/OFF							
	External VR	External volume (10 kΩ)							
Control method	● Phase control, ● Fixed cycle control, ● Variable cycle control, ● ON/OFF control								
Movement type	SOFT START / SOFT UP, DOWN								
Output voltage	More than 98 % of the Power voltage (In case of maximum current input)								
Cooling method	Natural cooling		Forced cooling		Natural cooling		Forced cooling		
Display method	Display by LED								
Insulation resistance	Min. 100 MΩ (based on 500 V d.c. mega)								
Output control range	0 ~ 100 %								
Dielectric strength	3000 V a.c. 50/60 Hz for 1 min								
Line noise	Noise by noise simulator (3000 V)								
Ambient temperature & humidity	0 ~ 40 °C, 30 ~ 85 % RH (without condensation)								
Storage temperature	-25 ~ 70 °C								
Weight (g)	1,388		1,478		2,820		3,100		

General type
3-phase

New product
General single
phase

MINI
Slim type
Single-phase,
three-phase

Slim type
phase

3 channels
Each phase
control

Slim type
3-phase

Suffix code

Model	Code				Content
TPR-2SL	<input type="checkbox"/>	<input type="checkbox"/>	<input type="checkbox"/>	<input type="checkbox"/>	Slim Type Single-Phase Thyristor Power Regulator
	040				Fuse optional
	055				
	070				
	090				
	110				Fuse built-in
	130				
	160				
	200				
Power voltage	L				100-240 V a.c. (Low voltage)
	H				380-440 V a.c. (High voltage)
Option	C				RS485
	F				Built-in fuse type (for 25/40/55/70 A models)



✘ The circuit need 100 - 240 V a.c. voltage power separately.

THYRISTOR POWER REGULATORS

TPR-3SL-EP

NEW

Specifications

Model	Low voltage	TPR-3SL040L-EP	TPR-3SL055L-EP	TPR-3SL070L-EP	TPR-3SL090L-EP	TPR-3SL130L-EP	TPR-3SL160L-EP
	High voltage	TPR-3SL040H-EP	TPR-3SL055H-EP	TPR-3SL070H-EP	TPR-3SL090H-EP	TPR-3SL130H-EP	TPR-3SL160H-EP
Appearance							
Power voltage	Low voltage	100-240 V a.c.					
	High voltage	100-440 V a.c.					
Circuit input power		100-240 V a.c. 18 W					
Power frequency		50/60 Hz (Common)					
Rated current		40 A	55 A	70 A	90 A	130 A	160 A
Applying load		Resistive load					
Current input		4-20 mA d.c. (Impedance : 100 Ω)					
Control type		● Phase control, ● Fixed cycle control, ● Variable cycle control, ● ON/OFF control					
Movement type		SOFT START / SOFT UP, DOWN					
Output voltage		More than 98 % of the Power voltage (In case of maximum current input)					
Cooling method		Forced cooling					
Display method		Display by LED					
Insulation resistance		Min. 100 MΩ (500 V d.c. Mega standard)					
Output control range		0 ~ 100 %					
Dielectric strength		3,000 V a.c. 50/60 Hz for 1 min					
Line noise		Noise by noise simulator (2500 V)					
Ambient temperature & humidity		0 ~ 40 °C, 30 ~ 85 % RH (without condensation)					
Storage temperature		-25 ~ 70 °C					
Weight (g)		4,324			9,194		9,288

Suffix code



Model	Code	Content
TPR-3SL	<input type="checkbox"/> <input type="checkbox"/> - <input type="checkbox"/>	3-Channel Each Phase Control Thyristor Power Regulator
Rated current	040	40 A
	055	55 A
	070	70 A
	090	90 A
	130	130 A
	160	160 A
Power voltage	L	100-240 V a.c. (Low voltage)
	H	100-440 V a.c. (High voltage)
Option	EP	Each phase control (individual control of 3 devices)

- ※ Circuit and fan need 100 - 240 V a.c. voltage power separately.
- ※ For 130 A, 160 A products, the fan need 24 V d.c. voltage power.

TPR-3CH-EC CE

NEW

Specifications

Model	Low voltage	TPR-3CH040L-EC	TPR-3CH055L-EC	TPR-3CH070L-EC	TPR-3CH090L-EC	TPR-3CH130L-EC	TPR-3CH160L-EC	
	High voltage	TPR-3CH040H-EC	TPR-3CH055H-EC	TPR-3CH070H-EC	TPR-3CH090H-EC	TPR-3CH130H-EC	TPR-3CH160H-EC	
Appearance								
Power voltage	Low voltage	100-240 V a.c.						
	High voltage	100-440 V a.c.						
Circuit power	Input voltage	24 V d.c.						
	Current consumption	208 mA			458 mA			
	Power Consumption	5 W			11 W			
Frequency used		50/60 Hz (Common)						
Rated current		40 A	55 A	70 A	90 A	130 A	160 A	
Applied load		Resistance load						
Control method		● Phase control, ● Fixed cycle cycle control, ● Variable cycle cycle control						
Starting method		SOFT START / DOWN						
Output voltage		98% or more of power supply voltage (at maximum current input)						
Cooling method		Forced cooling						
How to display		Output indication by LED						
Insulation Resistance		100 MΩ or more (based on 500 V d.c. mega)						
Output adjustment range		0 ~ 100 %						
Withstand voltage		3,000 V a.c. 1 minute at 50/60 Hz						
Line noise		Noise by noise simulator (2,500 V)						
Ambient temperature		0 ~ 40 °C (with no condensation)						
Ambient Humidity		30 ~ 85 % RH						
Storage temperature		-25 °C ~ 70 °C						
Weight(g)		4,324			9,194		9,288	

General type
3-phase

New product
General single
phase

MINI
Slim type
Single-phase,
three-phase

Slim type
phase

3 channels
Each phase
control

Slim type
3-phase

Suffix code



Model	Code	Content
TPR-3CH	<input type="checkbox"/> <input type="checkbox"/> - <input type="checkbox"/>	3-Channel Each Phase Control Thyristor Power Regulator
Rated current	040	40 A
	055	55 A
	070	70 A
	090	90 A
	130	130 A
	160	160 A
Power voltage	L	100-240 V a.c. (Low voltage)
	H	100-440 V a.c. (High voltage)
Option	EC	EtherCAT communication control

※ Circuit power and FAN power are separately 24 V d.c. Voltage must be applied.

SOLID STATE RELAYS

TPR-3SL

Specifications

Model	Low voltage	TPR-3SL040L	TPR-3SL055L	TPR-3SL070L	TPR-3SL090L	TPR-3SL130L	TPR-3SL160L
	High voltage	TPR-3SL040H	TPR-3SL055H	TPR-3SL070H	TPR-3SL090H	TPR-3SL130H	TPR-3SL160H
Appearance							
WXHXD(mm)	110.0×249.5×213.7			110.0×249.5×213.7		173.0×300.5×239.1	
Power voltage	Low voltage	100-240 V a.c.					
	High voltage	380-440 V a.c.					
Circuit input power	100-240 V a.c. 18 W			100-240 V a.c. 20 W			
Power frequency	50/60 Hz (Common)						
Rated current	40 A, 55 A, 70 A, 90 A, 130 A, 160 A						
Applying load	Resistive load						
Control Input	Current input	4-20mA d.c. (Impedance : 100 Ω)					
	Voltage input	1-5 V d.c.					
	Contact input	ON / OFF					
	External VR	External volume (10 KΩ)					
Control method	● Phase control, ● Fixed cycle cycle control, ● Variable cycle cycle control, ● ON/OFF control						
Movement type	SOFT START / SOFT UP, DOWN						
Output voltage	More than 98 % of the Power voltage (In case of maximum current input)						
Cooling method	Natural cooling (40 A, 55 A), Forced cooling (70 A, 90 A, 130 A, 160 A)						
Display method	Display by LED						
Insulation resistance	Min. 100 MΩ (Base on 500 V d.c. mega)						
Output control range	0 ~ 100 %						
Dielectric strength	3,000 V a.c. 50/60 Hz for 1 min						
Line noise	Noise by noise simulator (2500 V)						
Ambient temperature & humidity	0 ~ 40 °C, 30 ~ 85 % RH (without condensation)						
Storage temperature	-25 ~ 70 °C						
Weight (g)	4,044		4,324		9,100		9,194

Suffix code

Model	Code	Content
TPR-3SL	<input type="checkbox"/> <input type="checkbox"/> - <input type="checkbox"/>	Slim Type 3-Phase Power Regulator
Rated current	040	40 A
	055	55 A
	070	70 A
	090	90 A
	130	130 A
	160	160 A
Power voltage	L	100-240 V a.c. (Low voltage)
	H	380-440 V a.c. (High voltage)
Option	-	Fuse built-in
	N	No fuse

※ Circuit and fan need 100 - 240 V a.c. voltage power separately.

SSR-2C

NEW

Specifications

Model		SSR-2C252Z	SSR-2C402Z
Appearance			
Load	Load voltage	90-264 V a.c.	
	Peak voltage (non-repetitive)	600 V	
	Rated load current	25 A	40 A
	Frequency	50/60 Hz(Common)	
	Closing current (8.3 ms non-repetitive)	260 A	420 A
	Leakage current	10 mA or less	
	Output ON Voltage drop	1.8 V (RMS) or less	
Input	Voltage range	4-32 V d.c.	
	Impedance	4 kΩ or less	
	Operating voltage	3 V d.c. More than	
	Return voltage	1.5 V d.c. Below	
Response speed		1/2 Cycle + 1 ms max	
Insulation Resistance		500 V d.c. 100 MΩ (Between input and output and case)	
Withstand voltage		2,500 V a.c. (1 minute at 60 Hz)	
Vibration resistance		10 -55 Hz, double amplitude: 1.5 mm, 2 hours in each of X, Y and Z directions	
Shock resistance		1,000 mg, X · Y · Z 3 times each direction	
Storage temperature		-30 ~ 90 °C	
Ambient temperature		-20 ~ 80 °C (However, no condensation)	
Ambient Humidity		45 ~ 85 % RH	
Applied standard		IEC 62314	
Subordinate category		LC A	
Protection class		IP20	
Pollution level		Level 2	
Weight(g)		670	900

New product Phase

General type phase

Multifunctional 3-phase Radiator integrated type

New product 3-phase

General type 3-phase

Slim type phase Radiator integrated type

Slim type 2-line cutoff Radiator integrated type

Slim type 3-phase Radiator integrated type

Heatsink, PCB board phase

Configuration

Model	Code	Content
SSR-	<input type="checkbox"/> <input type="checkbox"/> <input type="checkbox"/> <input type="checkbox"/> <input type="checkbox"/>	Solid State Relay
phase	2	phase
Contact	C	2 Contact
Rated load current	25	25 A
	40	40 A
Used load voltage	2	90-264 V a.c.
How to operate	Z	Zero cross switching

SOLID STATE RELAYS

SSR-2 series CE

NEW

Specifications

- DC input - AC load

Model		Low voltage	SSR-2D102Z	SSR-2D202Z	SSR-2D302Z	SSR-2D402Z
		High voltage	SSR-2D104Z	SSR-2D204Z	SSR-2D304Z	SSR-2D404Z
Appearance						
WXHxD(mm)		42.0×64.0×27.3				
Load	Load voltage range	Low voltage	90-264 V a.c.			
		High voltage	90-480 V a.c.			
	Peak Voltage (Non-repetition)	Low voltage	600 V			
		High voltage	800 V	1,200 V		
	Rated load current		10 A	20 A	30 A	40 A
	Frequency		50/60 Hz (Common)			
	Surge current (8.3 ms No repetition)	Low voltage	170 A	260 A	420 A	
		High voltage	170 A	250 A	370 A	
	Leakage current		Max. 20 mA			
	Output ON voltage dropping		Less than 1.6 V (R.M.S)			
Input	Rated Voltage		5-24 V d.c.			
	Operating voltage range		4.6-32 V d.c.			
	Impedance		4 kΩ or less			
	Operation voltage		4.6 V d.c. More than			
	Input current		Constant-current system : 8 mA (±3)			
Response Time		1/2 Cycle + 1 ms max ("R" type below 1 ms)				
Insulating Resistance		500 V d.c., 100 MΩ (between the input / output and case)				
Dielectric strength		2,500 V a.c. (60 Hz for 1 min)				
Vibration resistance		10 - 55 Hz, double amplitude : 1.5 mm, X,Y, and Z direction for 2 hours				
Shock resistance		1,000 m/s ² , X,Y,Z each axis 3 times				
Storage temperature		-30 ~ 90 °C				
Ambient temperature & humidity		-5 ~ 40 °C, 45 ~ 85 % RH (without condensation)				
Pollution degree		Level 2				
purpose of use		Resistive load / inductive load				
Accepted standard		IEC 62314				
Weight (g)		89				

● AC input - AC load

Model		Low voltage	SSR-2A102Z	SSR-2A202Z	SSR-2A302Z	SSR-2A402Z	
		High voltage	SSR-2A104Z	SSR-2A204Z	SSR-2A304Z	SSR-2A404Z	
Appearance						New product Phase	
WXHxD(mm)						42.0×64.0×27.3	
Load	Load voltage range	Low voltage	90-264 V a.c.				Multifunctional 3-phase Radiator integrated type
		High voltage	90-480 V a.c.				New product 3-phase
	Peak Voltage (Non-repetition)	Low voltage	600 V				General type 3-phase
		High voltage	800 V	1,200 V			
	Rated load current		10 A	20 A	30 A	40 A	Slim type phase Radiator integrated type
	Frequency		50/60 Hz (Common)				
	Surge current (8.3 ms No repetition)	Low voltage	170 A	260 A	420 A		Slim type 2-line cutoff Radiator integrated type
		High voltage	170 A	250 A	370 A		
	Leakage current		Max. 20 mA				Slim type 3-phase Radiator integrated type
	Output ON voltage dropping		Less than 1.6 V (R.M.S)				
Input	Rated Voltage		100-240 V a.c.				Heatsink, PCB board phase
	Operating voltage range		70-264 V a.c.				
	Impedance		40 kΩ or less				
	Operation voltage		70 V a.c. More than				
	Input current		Constant-current system : 8 mA (±3)				
Response Time		1/2 Cycle + 1 ms max ("R" type below 1 ms)					
Insulating Resistance		500 V d.c., 100 MΩ (between the input / output and case)					
Dielectric strength		2,500 V a.c. (60 Hz for 1 min)					
Vibration resistance		10 - 55 Hz, double amplitude : 1.5 mm, X,Y, and Z direction for 2 hours					
Shock resistance		1,000 m/s ² , X,Y,Z each axis 3 times					
Storage temperature		-30 ~ 90 °C					
Ambient temperature & humidity		-5 ~ 40 °C, 45 ~ 85 % RH (without condensation)					
Pollution degree		Level 2					
purpose of use		Resistive load / inductive load					
Accepted standard		IEC 62314					
Weight (g)		89					

Suffix code

Model	Code	Content
SSR-2	<input type="checkbox"/> <input type="checkbox"/> <input type="checkbox"/> <input type="checkbox"/>	Single-phase general type solid state relay
Input voltage	D	5-24 V d.c.
	A	100-240 V a.c.
Rated load current	10	10 A
	20	20 A
	30	30 A
	40	40 A
Used load voltage	2	90-264 V a.c. (Low voltage)
	4	90-480 V a.c. (High voltage)
How it works	Z	Zero cross switching (standard product)
	R	Random switching

SOLID STATE RELAYS

HSR-2 series CE

Specifications

● DC input - AC load

Model		Low voltage	HSR-2D102□	HSR-2D202□	HSR-2D302□	HSR-2D402□	HSR-2D502□	HSR-2D702□
		High voltage	HSR-2D104□	HSR-2D204□	HSR-2D304□	HSR-2D404□	HSR-2D504□	HSR-2D704□
Appearance								
WXHxD(mm)		44,0×64,0×28,6						
Load	Usage Load Voltage	Low voltage	90-264 V a.c.					
		High voltage	90-480 V a.c.					
	Peak voltage (Non-repeating)	Low voltage	600 V				800 V	
		High voltage	800 V	1,200 V				
	Rated load current		10 A	20 A	30 A	40 A	50 A	70 A
	Frequency		25-65 Hz					
	Input current (8.3 ms non-repeating)	Low voltage	170 A	250 A	315 A		580 A	
		High voltage	170 A	250 A	350 A	370 A	580 A	
	Leakage current	Low voltage	15 mA					
		High voltage	20 mA					
Output ON voltage drop		1.3 V	1.6 V	1.8 V				
Input	Rated voltage		5-24 V d.c.					
	Operating voltage range		4-32 V d.c.					
	Impedance		4 kΩ or less					
	Operating voltage		3 V d.c. More than					
	Current input		Constant current method : 10 mA (± 3)					
Response time		1/2 cycle +1 ms max (1ms or less)						
Insulation Resistance		500 V d.c., 100 MΩ (Between input and output and case)						
Voltage withstand		2500 V a.c.(1 minute at 60 Hz)						
Vibration resistance		10-55 Hz, double amplitude : 1.5 mm X, Y, Z directions for 2 hours each						
Shock resistance		1000 m/s ² X, Y, Z directions 3 times each						
Storage temperature		-30 ~ 90 °C						
Ambient temperature and humidity		-20 ~ 80 °C, 45 ~ 85% RH (without condensation)						
Weight (g)	Radiator detachable type		150					
	Radiator integrated type		For 50 A: 1,400			For 70 A: 2,050		

● DC input - AC load

Model		Low voltage	HSR-2A102□	HSR-2A202□	HSR-2A302□	HSR-2A402□	HSR-2A502□	HSR-2A702□	
		High voltage	HSR-2A104□	HSR-2A204□	HSR-2A304□	HSR-2A404□	HSR-2A504□	HSR-2A704□	
Appearance									New product Phase
WXHxD(mm)		44.0×64.0×28.6							General type phase
Load	Usage Load Voltage	Low voltage	90-264 V a.c.						Multifunctional 3-phase Radiator integrated type
		High voltage	90-480 V a.c.						
	Peak voltage (Non-repeating)	Low voltage	600 V				800 V		New product 3-phase
		High voltage	800 V	1,200 V					
	Rated load current		10 A	20 A	30 A	40 A	50 A	70 A	General type 3-phase
	Frequency		25-65 Hz						Slim type phase Radiator integrated type
	Input current (8.3 ms non-repeating)	Low voltage	170 A	250 A	315 A		580 A		Slim type 2-line cutoff Radiator integrated type
		High voltage	170 A	250 A	350 A	370 A	580 A		
	Leakage current	Low voltage	15 mA						Slim type 3-phase Radiator integrated type
		High voltage	20 mA						
Output ON voltage drop		1.3 V	1.6 V	1.8 V					
Input	Rated voltage		100-240 V a.c.						Heatsink, PCB board phase
	Operating voltage range		90-264 V a.c.						
	Impedance		40 kΩ or less						
	Operating voltage		72 V a.c. More than						
	Current input		240 V a.c. / 9 mA (± 4)						
Response time		1/2 cycle +1 ms max (1ms or less)							
Insulation Resistance		500 V d.c., 100 MΩ (Between input and output and case)							
Voltage withstand		2500 V a.c.(1 minute at 60 Hz)							
Vibration resistance		10-55 Hz, double amplitude : 1.5 mm X, Y, Z directions for 2 hours each							
Shock resistance		1000 m/s² X, Y, Z directions 3 times each							
Storage temperature		-30 ~ 90 °C							
Ambient temperature and humidity		-20 ~ 80 °C, 45 ~ 85% RH (without condensation)							
Weight (g)	Radiator detachable type		150						
	Radiator integrated type		For 50 A : 1,400			For 70 A : 2,050			

Suffix code

Model	Code	Content
HSR-2	□ □ □ □ □	Single phase solid state relay
Voltage input	D	4-32 V d.c.
	A	90-264 V a.c.
Rated load current	10	10 A
	20	20 A
	30	30 A
	40	40 A
	50	50 A
	70	70 A
Load voltage	2	90-264 V a.c. (Low voltage)
	4	90-480 V a.c. (High voltage)
The mode of operationally	Z	Zero cross switching
	R	Random switching
W/W with radiator attached		No radiator
	T	Radiator integrated type (50 A, 70 A only)

SOLID STATE RELAYS

SSR-3 series CE

NEW

Specifications

● DC Input - AC Load

Model		Low voltage	SSR-3D102Z	SSR-3D202Z	SSR-3D302Z	SSR-3D402Z
		High voltage	SSR-3D104Z	SSR-3D204Z	SSR-3D304Z	SSR-3D404Z
Appearance						
W X H X D (mm)		109.0×60.0×31.3				
Load	Usage load voltage	Low voltage	90-264 V a.c.			
		High voltage	90-480 V a.c.			
	Peak voltage (Non-repeating)	Low voltage	600 V			
		High voltage	800 V	1,200 V		
	Rated load current		10 A	20 A	30 A	40 A
	Frequency		50/60 Hz (Common)			
	Input current (8.3 ms non-repeating)	Low voltage	170 A	260 A	420 A	
		High voltage	170 A	250 A	370 A	
Leakage current		20 mA or less				
Output ON voltage drop		1.6 V (RMS) or less				
Input	Rated voltage		5-24 V d.c.			
	Operating voltage range		4.6-32 V d.c.			
	Impedance		4 k Ω or less			
	Operating voltage		4.6 V d.c. More than			
	Current input		Constant current method: 12 mA (± 3)			
Response time		1/2 Cycle + 1 ms max ("R" type 1 ms or less)				
Insulation Resistance		500 V d.c., 100 M Ω (between input and output and case)				
Voltage withstand		2,500 V a.c. (1 minute at 60 Hz)				
Vibration resistance		10-55 ,, width of retrofit : 1.5 mm, X, Y, and Z for 2 hours each.				
Shock resistance		1,000 m/s ² , 3 times in each of X, Y, and Z directions				
Storage temperature		-30 ~ 90 °C				
Ambient temperature and humidity		-5 ~ 40 °C, 45 ~ 85 % RH (without condensation)				
Pollution degree		Level 2				
Use Purpose		resistive/inductive loads				
Application Specification		IEC 62314				
Weight (g)		227				

Suffix code

Model	Code	Content
SSR-3	<input type="checkbox"/> <input type="checkbox"/> <input type="checkbox"/> <input type="checkbox"/>	3-phase, normal contactless relay
Input voltage	D	5-24 V d.c.
	A	100-240 V a.c.
Rated load current	10	10 A
	20	20 A
	30	30 A
	40	40 A
Used load voltage	2	90-264 V a.c. (Low voltage)
	4	90-480 V a.c. (High voltage)
The mode of operationally	Z	Zero Cross Switching (Standard)
	R	Random switching

● AC Input - AC Load

Model		Low voltage	SSR-3A102Z	SSR-3A202Z	SSR-3A302Z	SSR-3A402Z
		High voltage	SSR-3A104Z	SSR-3A204Z	SSR-3A304Z	SSR-3A404Z
Appearance						
W X H X D (mm)		109.0×60.0×31.3				
Load	Usage load voltage	Low voltage	90-264 V a.c.			
		High voltage	90-480 V a.c.			
	Peak voltage (Non-repeating)	Low voltage	600 V			
		High voltage	800 V	1,200 V		
	Rated load current		10 A	20 A	30 A	40 A
	Frequency		50/60 Hz (Common)			
	Input current (8.3 ms non-repeating)	Low voltage	170 A	260 A	420 A	
		High voltage	170 A	250 A	370 A	
	Leakage current		20 mA or less			
	Output ON voltage drop		1.6 V (RMS) or less			
Input	Rated voltage		100-240 V a.c.			
	Operating voltage range		70-26 4V a.c.			
	Impedance		40 kΩ or less			
	Operating voltage		70 V a.c. More than			
	Current input		Constant current method: 12 mA (±3)			
Response time		1/2 Cycle + 1 ms max ("R" type 1 ms or less)				
Insulation Resistance		500 V d.c., 100 MΩ (between input and output and case)				
Voltage withstand		3,000 V a.c. (1 minute at 60 Hz)				
Vibration resistance		10-55 Hz , width of retrofit : 1.5 mm, X, Y, and Z for 2 hours each.				
Shock resistance		1,000 m/s ² , 3 times in each of X, Y, and Z directions				
Storage temperature		-30 ~ 90 °C				
Ambient temperature and humidity		-5 ~ 40 °C, 45 ~ 85 % RH (without condensation)				
Pollution degree		Level 2				
Use Purpose		resistive/inductive loads				
Application Specification		IEC 62314				
Weight (g)		227				

New product Phase
General type phase
Multifunctional 3-phase Radiator integrated type
New product 3-phase
General type 3-phase
Slim type phase Radiator integrated type
Slim type 2-line cutoff Radiator integrated type
Slim type 3-phase Radiator integrated type
Heatsink, PCB board phase

Suffix code

Model	Code	Content
SSR-3	<input type="checkbox"/> <input type="checkbox"/> <input type="checkbox"/> <input type="checkbox"/>	3-phase, normal contactless relay
Input voltage	D	5-24 V d.c.
	A	100-240 V a.c.
Rated load current	10	10 A
	20	20 A
	30	30 A
	40	40 A
Used load voltage	2	90-264 V a.c. (Low voltage)
	4	90-480 V a.c. (High voltage)
The mode of operationally	Z	Zero Cross Switching (Standard)
	R	Random switching

SOLID STATE RELAYS

HSR-3 series CE

Specifications

- DC input-AC load (for low voltage : 90-264 V a.c.)

Model		Low voltage	HSR-3D102□	HSR-3D202□	HSR-3D302□	HSR-3D402□	HSR-3D502□	HSR-3D702□	
		High voltage	HSR-3D104□	HSR-3D204□	HSR-3D304□	HSR-3D404□	HSR-3D504□	HSR-3D704□	
Appearance									
WXHxD(mm)		109.0×74.8×34.5							
Load	Usage Load Voltage	Low voltage	90-264 V a.c.						
		High voltage	90-480 V a.c.						
	Peak voltage (Non-repeating)	Low voltage	600 V				800 V		
		High voltage	800 V	1,200 V					
	Rated load current		10 A	20 A	30 A	40 A	50 A	70 A	
	Frequency		25-65 Hz						
	Input current (8.3 ms non-repeating)	Low voltage	125 A	260 A	315 A		580 A		
		High voltage	170 A	250 A	315 A		580 A		
	Leakage current	Low voltage	1.5 mA	1.8 mA or less				1.5 mA	
		High voltage	20 mA or less						
Output ON voltage drop	Low voltage	1.5 V	1.8 V						
	High voltage	1.95 V	1.8 V						
Input	Rated voltage		5-24 V d.c.						
	Operating voltage range		4-32 V d.c.						
	Impedance		4 kΩ or less						
	Operating voltage		3 V d.c. More than						
	Current input		Constant current method: 14 mA (± 3)						
Response time		1/2cycle + 1 ms max (less than 1 ms)							
Insulation Resistance		500 V d.c., 100 MΩ (between input and output and case)							
Withstand voltage		2,500 V a.c. (1 minute at 60Hz)							
Vibration resistance		10-55 Hz, double amplitude : 1.5 mm, 2 hours in each of X, Y, and Z directions							
Shock resistance		1,000 m/s ² , 3 times in each of X, Y, and Z directions							
Storage temperature		-30 ~ 90 °C							
Ambient temperature and humidity		-20 ~ 80 °C, 45 ~ 85% RH (without condensation)							
Weight (g)	Radiator detachable type		400				-		
	Radiator integrated type		-				2,000	2,600	

● AC input-AC load

Model		Low voltage	HSR-3D102□	HSR-3D202□	HSR-3D302□	HSR-3D402□	HSR-3D502□	HSR-3D702□	
		High voltage	HSR-3D104□	HSR-3D204□	HSR-3D304□	HSR-3D404□	HSR-3D504□	HSR-3D704□	
Appearance									New product Phase
WXHxD(mm)		109.0×74.8×34.5							General type phase
Load	Usage Load Voltage	Low voltage	100-240 V a.c.						New product 3-phase
		High voltage	90-264 V a.c.						
	Peak voltage (Non-repeating)	Low voltage	600 V				800 V		General type 3-phase
		High voltage	800 V	1,200 V					
	Rated load current		10 A	20 A	30 A	40 A	50 A	70 A	Slim type phase Radiator integrated type
	Frequency		25-65 Hz						
	Input current (8.3 ms non-repeating)	Low voltage	125 A	260 A	315 A		580 A		Slim type 2-line cutoff Radiator integrated type
		High voltage	170 A	250 A	315 A		580 A		
	Leakage current	Low voltage	20 mA				1.5 mA		Slim type 3-phase Radiator integrated type
		High voltage	20 mA or less						
Output ON voltage drop	Low voltage	1.5 V	1.8 V						Heatsink, PCB board phase
	High voltage	1.95 V	1.8 V						
Input	Rated voltage		100-240 V a.c.						
	Operating voltage range		90-264 V a.c.						
	Impedance		40 kΩ or less						
	Operating voltage		72 V a.c. More than						
	Current input		240 V a.c. / 9 mA (± 4)						
Response time		1/2 cycle + 1 ms max (less than 1 ms)							
Insulation Resistance		500 V d.c., 100 MΩ (between input and output and case)							
Withstand voltage		2,500 V a.c. (1 minute at 60Hz)							
Vibration resistance		10-55 Hz, double amplitude : 1.5 mm, 2 hours in each of X, Y, and Z directions							
Shock resistance		1,000 m/s², 3 times in each of X, Y, and Z directions							
Storage temperature		-30 ~ 90 °C							
Ambient temperature and humidity		-20 ~ 80 °C, 45 ~ 85% RH (without condensation)							
Weight (g)	Radiator detachable type		400				-		
	Radiator integrated type		-				2,000	2,600	

Suffix code

Model	Code	Content
HSR-3	□ □ □ □ □	3-Phase solid-state relay
Voltage input	D	4-32 V d.c.
	A	90-264 V a.c.
Rated load current	10	10 A
	20	20 A
	30	30 A
	40	40 A
	50	50 A
	70	70 A
Load voltage	2	90-264 V a.c. (Low voltage)
	4	90-480 V a.c. (High voltage)
The mode of operationally	Z	Zero cross switching (standard product)
	R	Random switching
Whether or not radiator is attached		No radiator
	T	Radiator integrated type (50 A, 70 A only)

(Note) Operation method Z : Zero cross switching, R : Random switching

SOLID STATE RELAYS

HSR-SL series

Specifications

Model		Low voltage	HSR-SLD152Z	HSR-SLD252Z	HSR-SLD402Z
		High voltage	HSR-SLD154Z	HSR-SLD254Z	HSR-SLD404Z
Appearance					
WXHxD(mm)		CE	22.4×99.0×98.5		44.4×99.0×98.5
		S-MARK	22.4×99.0×98.5	44.4×99.0×98.5	85.0×114.0×118.0
Load	Usage Load Voltage	Low voltage	90-264 V a.c.		
		High voltage	90-480 V a.c.		
	Peak voltage (Non-repeating)	Low voltage	600 V		
		High voltage	800 V	1,200 V	
	Rated load current		15 A	25 A	40 A
	Frequency		50/60 Hz (Common)		
	Input current (8.3 ms non-repeating)	Low voltage	170 A	260 A	420 A
		High voltage	170 A	250 A	370 A
	Leakage current		20 mA or less		
	Output ON voltage drop		1.6 V (RMS) or less		
Input	Rated voltage		5-24 V d.c.		
	Operating voltage range		4-32 V d.c.		
	Impedance		4 kΩ or less		
	Operating voltage		3 V d.c. More than		
	Return voltage		1.5 V d.c. or less		
	Current input		Constant current method: 8 mA (±3)		
Response time		1/2 Cycle + 1 ms max. ("R" type 1 ms or less)			
Insulation Resistance		500 V d.c., 100 MΩ (between input and output and case)			
Withstand voltage		3,000 V a.c. (1 minute at 60 Hz)			
Vibration resistance		10-55 Hz, double amplitude : 1.5 mm, 2 hours in each of X, Y, and Z directions			
Shock resistance		1,000 m/s ² , 3 times in each of X, Y, and Z directions			
Storage temperature		-30 ~ 90 °C			
Ambient temperature and humidity		-5 ~ 40 °C, 45 ~ 85% RH (However, there should be no condensation)			
Pollution degree		Level 2			
Use Purpose		Resistive load / inductive load			
Applied standard		IEC 62314			
Weight (g)		230		372	

Suffix code

Model	Code	Content
HSR-SL	<input type="checkbox"/> <input type="checkbox"/> <input type="checkbox"/> <input type="checkbox"/> <input type="checkbox"/> <input type="checkbox"/>	Slim type single phase solid state relay
Input voltage	D	4-32 V d.c.
Contact	-	1 Contact (no mark)
	2C	2 contacts (15 A only)
Rated load current	15	15 A
	25	25 A
	40	40 A
Used load voltage	2	90-264 V a.c. (Low voltage)
	4	90-480 V a.c. (High voltage)
The mode of operationally	Z	Zero cross switching (standard product)
	R	Random switching
Optional	BI	Bimetal 60 °C / 80 °C mark

※ The 2-contact type is only available for the low/high voltage type of 15 A product. (HSR-SLD2C152Z, HSR-SLD2C154Z)

HSR-2SLD series



Specifications

Model		Low voltage	HSR-2SLD252Z	HSR-2SLD402Z
		High voltage	HSR-2SLD254Z	HSR-2SLD404Z
Appearance				
WXHxD(mm)		Low voltage	79.0×96.6×131.3	95.0×96.6×156.7
		High voltage		110.0×133.0×140.1
Load	Usage Load Voltage	Low voltage	90-264 V a.c.	
		High voltage	90-480 V a.c.	
	Peak voltage (Non-repeating)	Low voltage	600 V	
		High voltage	1,200 V	
	Rated load current		25 A	40 A
	Frequency		50/60 Hz (Common)	
	Input current (8.3 ms non-repeating)	Low voltage	260 A	420 A
		High voltage	250 A	370 A
Leakage current		10 mA or less		
Output ON voltage drop		1.8 V (RMS) or less		
Rated impulse withstand voltage	Low voltage	4 kV		
	High voltage	6 kV		
Input	Rated voltage		5-24 V d.c.	
	Operating voltage range		4-32 V d.c.	
	Impedance		4 kΩ or less	
	Operating voltage		3 V d.c. More than	
	Return voltage		1.5 V d.c. or less	
	Current input		Constant current method : 10 mA (±3)	
Detection unit	Rated voltage		24 V d.c.	
	Operating voltage range		20-26 V d.c.	
	Power Consumption		25 mA or less, 40 mA or less in case of alarm output (based on 24 V d.c.)	
	Collector internal pressure		30 V d.c. or less	
	Current through current		50 mA or less	
	Collector power consumption		500 mW	
	Output form		Transistor open collector (High when abnormality is detected)	
Response time		1/2 Cycle + 1 ms max. ("R" type 1 ms or less)		
Insulation Resistance		500 V d.c., 100 MΩ (between input and output and case)		
Withstand voltage		2,500 V a.c. (1 minute at 60 Hz)		
Vibration resistance		10-55 Hz, double amplitude : 1.5 mm, 2 hours in each of X, Y, and Z directions		
Shock resistance		1,000 m/s², 3 times in each of X, Y, and Z directions		
Storage temperature		-30 ~ 90 °C		
Ambient temperature and humidity		-20 ~ 80 °C, 45 ~ 85 % RH (without condensation)		
Pollution degree		Level 2		
Protection structure		IP20 (IEC 60529)		
Purpose of use		Resistive load / inductive load		
Applied standard		IEC 62314		
Weight (g)		1,000	1,300	

New product Phase
General type phase
Multifunctional 3-phase Radiator integrated type
New product 3-phase
General type 3-phase
Slim type phase Radiator integrated type
Slim type 2-line cutoff Radiator integrated type
Slim type 3-phase Radiator integrated type
Heatsink, PCB board phase

Suffix code

Model	Code	Content
HSR-2SLD	<input type="checkbox"/> <input type="checkbox"/> <input type="checkbox"/>	2-wire cut-off alarm output solid-state relay (alarm open collector output)
Rated load current	25	25 A
	40	40 A
Used load voltage	2	90-264 V a.c. (Low voltage)
	4	90-480 V a.c. (High voltage)
The mode of operationally	Z	Zero cross switching (standard product)
	R	Random switching

SOLID STATE RELAYS

HSR-3SL series

Specification



Model		Low voltage	HSR-3SLD152Z	HSR-3SLD252Z	HSR-3SLD402Z
		High voltage	HSR-3SLD154Z	HSR-3SLD254Z	HSR-3SLD404Z
Appearance					
WXHxD(mm)		79.0×96.6×120.0			95.0×96.6×146.0
Load	Usage Load Voltage	Low voltage	90-264 V a.c.		
		High voltage	90-480 V a.c.		
	Peak voltage (Non-repeating)	Low voltage	600 V		
		High voltage	800 V	1,200 V	
	Rated load current		15 A (40 °C)	25 A (25 °C)	40 A (25 °C)
	Frequency		50/60 Hz (Common)		
	Input current (8.3 ms non-repeating)	Low voltage	170 A	260 A	420 A
		High voltage	170 A	250 A	370 A
	Leakage current		20 mA or less		
	Output ON voltage drop		1.6 V (RMS) or less		
Input	Rated voltage		5-24 V d.c.		
	Operating voltage range		4-32 V d.c.		
	Impedance		4 kΩ or less		
	Operating voltage		3 V d.c. More than		
	Return voltage		1.5 V d.c. or less		
	Current input		Constant current method : 10 mA (±3)		
Response time		1/2 Cycle + 1 ms max. ("R" type 1 ms or less)			
Insulation Resistance		500 V d.c., 100 MΩ (between input and output and case)			
Withstand voltage		3,000 V a.c. (1 minute at 60 Hz)			
Vibration resistance		10-55 Hz, double amplitude : 1.5 mm, 2 hours in each of X, Y, and Z directions			
Shock resistance		1,000 m/s ² , 3 times in each of X, Y, and Z directions			
Storage temperature		-30 ~ 90 °C			
Ambient temperature and humidity		-20 ~ 80 °C, 45 ~ 85 % RH (without condensation)			
Weight (g)		1,000			1,300

Suffix code

Model	Code	Content
HSR-3SL	<input type="checkbox"/> <input type="checkbox"/> <input type="checkbox"/> <input type="checkbox"/>	Slim type 3-phase solid-state relay
Input voltage	D	4-32 V d.c.
Rated load current	15	15 A
	25	25 A
	40	40 A
Used load voltage	2	90-264 V a.c. (Low voltage)
	4	90-480 V a.c. (High voltage)
The mode of operationally	Z	Zero cross switching (standard product)
	R	Random switching

HSP/HSM/HSN series

HSP series / HSM series

Model	HSP-10	HSP-20	HSP-40	HSM-70	HSM-110	HSM-150	HSM-200	HSM-250
		HSR-2□10□□	HSR-2□20□□	HSR-2□30□□ HSR-2□40□□	HSR-2□10□□	HSR-2□20□□ HSR-2□30□□	HSR-2□40□□ HSR-3□10□□	HSR-3□20□□ HSR-3□30□□
Appearance								
Capacity	10 A	20 A	30 A	10 A	20 A	40 A	20 A	40 A
Length (mm)	48	80	109	70	110	150	200	250

HSN series

Model	HSN-80	HSN-120	HSN-80-F	HSN-120-F
		HSR-2□50□□	HSR-2□70□□	HSR-3□50□□
With or without fan	Without	Without	With	With
Appearance				
Capacity	50 A	70 A	50 A	70 A
Length (mm)	80	120	92X92X25T	92X92X25T

HSR-PD series

Specifications

Model		HSR-PD032Z	HSR-PD052Z	HSR-PD082Z
Appearance				
WXHxD(mm)		35.0×19.0×8.0	37.5×23.2×10.6	35.0×36.7×20.0
Load	Rated load voltage	100-220 V a.c.		
	Used load voltage	90-240 V a.c.		
	Peak voltage (non-repeating)	600 V		
	Rated load current	3 A	5 A	8 A
	Frequency	50/60 Hz		
	Input current	30 A	60 A	120 A
	Leakage current	10 mA or less		
Input	Output ON voltage drop	1.6 V (rms) or less		
	Rated voltage	5-24 V d.c.		
	Operating voltage range	4-32 V d.c.		
	Impedance	4 kΩ or less		
	Operating voltage	3 V d.c. More than		
	Return voltage	1.5 V d.c. or less		
Current input	Constant current method : 10 mA (±3)			
Response time	1/2 cycle + 1 ms max			
Insulation Resistance	500 V d.c., 100 MΩ (between input and output and case)			
Voltage withstand	2500 V a.c. (1 minute at 60 Hz)			
Vibration resistance	10-55 Hz, double amplitude : 1.5 mm, 2 hours in each of X, Y, and Z directions			
Shock resistance	100 m/s ² , 3 times each in X, Y, Z directions			
Storage temperature	-30 ~ 90 °C			
Ambient temperature and humidity	-20 ~ 80 °C, 45 ~ 85 % RH (without condensation)			
Weight (g)	10	22	27	

Suffix code













Model	Code	Content
HSR-P	□ □ □ □	Single-phase solid-state relay for printed circuit boards
Input voltage	D	4-32 V d.c.
Rated load current	03	3 A
	05	5 A
	08	8 A
Used load voltage	2	90-240 V a.c. (Low voltage)
The mode of operationally	Z	Zero cross switching
	R	Random switching

New product Phase
General type phase
Multifunctional 3-phase Radiator integrated type
New product 3-phase
General type 3-phase
Slim type phase Radiator integrated type
Slim type 2-line cutoff Radiator integrated type
Slim type 3-phase Radiator integrated type
Heatsink, PCB board phase

POWER SUPPLIES

TPS series

Specifications









Model	TPS-15S	TPS-30S	TPS-50S	TPS-75S	TPS-100S
Appearance	 	 	 	 	
W×H×D (mm)	64.1×97.6×32.0	79.0×98.0×37.0	83.0×125.0×38.8	96.0×135.0×40.2	93.0×199.0×50.0
Power output	15 W	30 W	50 W	75 W	100 W
Input voltage	Free voltage 100-240 V a.c. (50/60 Hz)				Manual-select input 100-120 V a.c. 50/60 Hz/ 200-240 V a.c. 50/60 Hz
Output voltage	5 V, 12 V, 15 V, 24 V d.c.			5 V, 12 V, 15 V, 24 V d.c.	
Voltage fluctuation range	±5 ~ ±10 % (Varies due to the internal VR)				
Protective circuit	● Overcurrent, ● Overvoltage, ● Overheating, ● Output short-circuit protection				
Dielectric strength	● 2,700 V a.c. 1 minute, detection current = 10 mA, (input-output) ● 1,500 V a.c. 1 minute, detection current = 10 mA, (input-FG) ● 500 V a.c. 1 minute, detection current = 10 mA, (output-FG)				
Insulation resistance	100 MΩ min, 500Vd.c. (Input - Output)				
Model	TPS-150S	TPS-220S	TPS-350S	TPS-450S	
Appearance					
W×H×D (mm)	93.0×209.0×65.0	93.0×209.0×65.0	115.0×230.0×50.0	115.0×230.0×50.0	
Power output	150 W	220 W	350 W	450 W	
Input voltage	Manual-select input 100-120 V a.c. 50/60 Hz / 200-240 V a.c. 50/60 Hz			Free voltage 100-240 V a.c. 50/60 Hz	
Output voltage	5 V, 12 V, 15 V, 24 V d.c.	12 V, 15 V, 24 V d.c.	12 V, 24 V, 48 V d.c.		
Voltage fluctuation range	±5 ~ ±10 % (Depends on internal VR)				
Protective circuit	● Overcurrent, ● Overvoltage, ● Overheating, ● Output short-circuit protection				
Dielectric strength	● 2,700 V a.c. 1 minute, detection current = 10 mA, (input-output) ● 1,500 V a.c. 1 minute, detection current = 10 mA, (input-FG) ● 500 V a.c. 1 minute, detection current = 10 mA, (output-FG)				
Insulation resistance	100 MΩ min, 500 V d.c. (Input-output)				

Suffix code

Model	Code	Content
TPS-	<input type="checkbox"/> <input type="checkbox"/> - <input type="checkbox"/>	Enclosed Type
Power output	15	15 W
	30	30 W
	50	50 W
	75	75 W
	100	100 W
	150	150 W
	220	220 W
	350	350 W
450	450 W	
Number of output voltage	S	1 Output
Output voltage classification	05	5 V d.c. (220 W, 350 W, 450 W Exclude)
	12	12 V d.c.
	15	15 V d.c. (350 W, 450 W Exclude)
	24	24 V d.c.
	48	48 V d.c. (15 W, 30 W, 50 W, 75 W, 100 W, 150 W, 220 W Exclude)

DPS series

Specifications

Model	DPS-15S	DPS-30S	DPS-50S	DPS-75S
Appearance				
W×H×D (mm)	25.0×90.0×103.0	40.0×90.0×103.0	40.0×90.0×103.0	56.0×124.0×97.8
Power output	15 W	30 W	50 W	75 W
Input voltage	100-240 V a.c. (Free power)			
Output voltage	5 V, 12 V, 15 V, 24 V d.c.			12 V, 24 V, 48 V d.c.
Voltage fluctuation range	±5 ~ 10 % (Varies due to the internal VR)			
Protective circuit	● Overcurrent, ● Overvoltage, overhear, ● Output short-circuit protection, ● DC OK display function			
Dielectric strength	● 2,700 V a.c. 1 minute, detection current = 10 mA, (input-output) ● 500 V a.c. 1 minute, detection current = 10 mA, (output-FG)		● 1,500 V a.c. 1 minute, detection current = 10 mA, (input-FG) ● 500 V a.c. 1 minute, detection current = 10 mA, (output-DC OK)	
Insulation resistance	50MΩ or more. (Input-Output, FG), (Output-FG, DC OK)			
Model	DPS-100S	DPS-120S	DPS-180S	DPS-240S
Appearance				
W×H×D (mm)	56.0×124.0×97.8	66.0×124.0×97.8	66.0×124.0×97.8	125.5×124.0×97.8
Power output	100 W	120 W	180 W	240 W (※ However, DPS-240S-12 is 216W)
Input voltage	100-240 V a.c. 50/60 Hz (Free power)	100-120 V a.c. 50/60 Hz/ 200-240 V a.c. 50/60 Hz(Automatic input selection)		
Output voltage	12 V, 24 V, 48 V d.c.		24 V, 48 V d.c.	12 V, 24 V, 48 V d.c.
Voltage fluctuation range	±5 ~ 10 % (Depends on internal VR)			
Protective circuit	● Overcurrent, ● Overvoltage, Overheat, ● Output short-circuit protection, ● DC OK display, ● DC OK output function			
Dielectric strength	● 2,700 V a.c. 1 minute, detection current = 10 mA, (input-output) ● 500 V a.c. 1 minute, detection current = 10 mA, (output-FG)		● 1,500 V a.c. 1 minute, detection current = 10 mA, (input-FG) ● 500 V a.c. 1 minute, detection current = 10 mA, (output-DC OK)	
Insulation resistance	50MΩ or more (input-output, FG), (output-FG, DC OK)			



Enclosed type
DIN rail type
Small type DIN rail type

Suffix code

Model	Code	Content
DPS-	<input type="checkbox"/> <input type="checkbox"/> <input type="checkbox"/>	DPS Power Supply (DIN Rail Type)
Power output	15	15 W
	30	30 W
	50	50 W
	75	75 W
	100	100 W
	120	120 W
	180	180 W
	240	240 W (※ only DPS-240S-12 : 216 W)
Number of output voltage	S	1 Output (single output)
Output voltage classification	05	5 V d.c. (DPS-75S, DPS-100S, DPS-120S, DPS-180S, DPS-240S excluded)
	12	12 V d.c. (DPS-180S excluded)
	15	15 V d.c. (DPS-75S, DPS-100S, DPS-120S, DPS-180S, DPS-240S excluded)
	24	24 V d.c.
	48	48 V d.c. (DPS-15S, DPS-30S, DPS-50S excluded)

HNPS series

Specifications

Model	HNPS-03S	HNPS-07S
Appearance		
W×H×D (mm)	36.0×80.0×65.0	
Power output	3 W	7.5W
Input voltage	100-240 V a.c. 50/60 Hz ±10% of power supply voltage	
Output voltage	5 V, 12 V, 15 V, 24 V	
Voltage fluctuation range	±5 ~ 10 % (varies due to the internal VR)	
Protective circuit	Over voltage, Over current, Over heat, Short circuit	
Dielectric strength	<ul style="list-style-type: none"> ● 3 kVAC (between input and output), 1.5 kVAC (between input and FG), ● 500 V a.c. (Between output and FG), (detection current: 10 mA, for 1 min) 	
Insulation Resistance	100 MΩ or more (between input and output, at 500 V d.c.)	
Weight (g)	120	

Suffix code

Model	Code	Content
HNPS-	<input type="checkbox"/> <input type="checkbox"/> <input type="checkbox"/> <input type="checkbox"/>	DPS Power Supply (DIN Rail Type)
Power output	03	3 W
	07	7.5 W
Number of output voltage	S	1 Output (Single output)
Output voltage classification	05	5 V d.c.
	12	12 V d.c.
	15	15 V d.c.
	24	24 V d.c.
Structure	D	Rail structure (DIN)

DR series



Product composition

Model	Push button switch					
	Chrome plated guard type		Plastic guard type		Plastic guard type	
	Flat Ø22	Protrusion Ø16	Flat Ø22	Protrusion Ø16	Square Ø16	Rectangular Ø16
Appearance						
Actuator code	DRF-A	DRF-R	DRF-K	DRF-T	DRF-S	DRF-O
Model	Illuminated pushbutton switch					
	Chrome plated guard type		Plastic guard type		Plastic guard type	
	Flat Ø22	Protrusion Ø16	Flat Ø22	Protrusion Ø16	Square Ø16	Rectangular Ø16
Appearance						
Actuator code	DRX-A	DRX-R	DRX-K	DRX-T	DRX-S	DRX-O
Model	Indicator light					
	Chrome plated guard type		Plastic guard type		Plastic guard type	
	Flat Ø22	Protrusion Ø16	Flat Ø22	Protrusion Ø16	Square Ø16	Rectangular Ø16
Appearance						
Actuator code	DRP-A	DRP-R	DRP-K	DRP-T	DRP-S	DRP-O
Model	Selector switch					
	Chrome plated guard type		Plastic guard type		Plastic guard type	
	Flat Ø22	Protrusion Ø16	Flat Ø22	Protrusion Ø16	Square Ø16	Rectangular Ø16
Appearance						
Actuator code	DRS-A	DRS-R	DRS-K	DRS-T	DRS-S	DRS-O
Model	Illuminated selector switch					
	Chrome plated guard type		Plastic guard type		Plastic guard type	
	Flat Ø22	Protrusion Ø16	Flat Ø22	Protrusion Ø16	Square Ø16	Rectangular Ø16
Appearance						
Actuator code	DRT-A	DRT-R	DRT-K	DRT-T	DRT-S	DRT-O
Model	KEY selector switch					
	Chrome plated guard type		Plastic guard type		Plastic guard type	
	Flat Ø22	Protrusion Ø16	Flat Ø22	Protrusion Ø16	Square Ø16	Rectangular Ø16
Appearance						
Actuator code	DRK-A	DRK-R	DRK-K	DRK-T	DRK-S	DRK-O

- New product Control switch
- High-end Control switch
- New product assembly indicator light Rectangular indicator light
- Power switch Main switch
- Cam switch
- Limit switch
- Micro switch
- Foot switch Mono lever switch
- Hoist switch

CONTROL SWITCHES

Model	Emergency stop switch			
	Chrome plated guard type		Plastic guard type	
	Flat Ø22	Protrusion Ø16	Flat Ø22	Protrusion Ø16
Appearance				
Actuator code	DRE-AM	DRE-RM	DRE-KM	DRE-TM
Appearance				
Actuator code	DRE-AA	DRE-RA	DRE-KA	DRE-TA
Appearance				
Actuator code	DRE-AR	DRE-RR	DRE-KR	DRE-TR
Model	Illuminated emergency stop switch			
	Chrome plated guard type		Plastic guard type	
	Flat Ø22	Protrusion Ø16	Flat Ø22	Protrusion Ø16
Appearance				
Actuator code	DRA-AM	DRA-RM	DRA-KM	DRA-TM
Appearance				
Actuator code	DRA-AA	DRA-RA	DRA-KA	DRA-TA
Appearance				
Actuator code	DRA-AR	DRA-RR	DRA-KR	DRA-TR

Accessories

Model	Emergency protection cover	Front protective cover			Anti-rotation ring
	HEG-16 (Protrusion)	HSC-16P (Protrusion)	HSC-16PS (Protruding square)	HSC-22F (Flat)	DR Ø16 Anti-rotation ring
Application Model	DRE-R, DRE-T, DRA-R, DRA-T	DRF-R, DRF-T, DRX-R, DRX-T	DRF-S, DRF-O, DRX-S, DRX-O	DRF-A, DRS-K, DRX-A, DRX-K	Ø16 Common
Appearance					

Suffix Code

Model	Code	Content
DRF -	□	Push button switch
DRX -	□	Illuminated pushbutton switch
DRP -	□	Indicator light
DRS -	□	Selector switch
DRT -	□	Illuminated selector switch
DRK -	□	Key selector switch
DRE -	□	Emergency stop switch
DRA -	□	Illuminated emergency stop switch
Control part shape	A	Ø22 Flat
	R	Ø16 Protrusion
	K	Ø22 Flat
	T	Ø16 Protrusion
	S	Ø16 Square
	O	Ø16 Rectangular
		Chrome plated guard
		Plastic guard

Specification

Rating	250 V a.c. 3 A	
Insulation Resistance	100MΩ or more	
Withstand voltage	1500 V a.c. 1 minute at 50/60 Hz	
Contact contact resistance	50 MΩ or less	
Vibration resistance	10-55 Hz double amplitude 3 mm	
Shock resistance	Approx. 50 G (500 $\frac{m}{s^2}$)	
Ambient temperature	-10 ~ 50 °C	
Ambient humidity	45 ~ 85 % RH	
Opening and closing frequency	Up to 30 times/min	
life	Electrical	200,000 times or more / 1,800 h
	Mechanical	1 million times or more / 1,800 h
Certification		

CR series

NEW

Product composition

Model	Push button switch					
	Illuminated pushbutton switch					
	Flat Ø30	Protrusion Ø30	Protective guard Ø30	Flat Ø25	Protrusion Ø25	Protective guard Ø25
Appearance						
Actuator code	CRX-F30	CRX-P30	CRX-G30	CRX-F25	CRX-P25	CRX-G25
Model	Indicator light					
	Flat Ø30	Flat Ø25				
Appearance						
Actuator code	CRP-30					
	CRP-25					
Model	Selector switch					
	Short lever		Long lever			
	Flat Ø30	Flat Ø25	Flat Ø30	Flat Ø25		
Appearance						
Actuator code	CRS-30	CRS-25	CRSL-30	CRSL-25		
Model	Illuminated selector switch					
	Flat Ø30	Flat Ø25	Flat Ø30	Flat Ø25		
외형						
Actuator code	CRT-30	CRT-25	CRTL-30	CRTL-25		
Model	KEY selector switch					
	Flat Ø30	Flat Ø25				
Appearance						
Actuator code	CRK-30					
	CRK-25					

New product
Control switch

High-end
Control switch

New product
assembly
Indicator light
Rectangular
indicator light

Power switch
Main switch

Cam switch

Limit
switch

Micro
switch









Foot switch
Mono lever
switch

Hoist
switch

CONTROL SWITCHES

Model	Emergency stop switch	
	Flat Ø30	Flat Ø25
Appearance		
Actuator code	CRE-30M	CRE-25M
Appearance		
Actuator code	CRE-30R	CRE-25R
Model	Illuminated emergency stop switch	
	Flat Ø30	Flat Ø25
Appearance		
Actuator code	CRA-30M	CRA-25M
Appearance		
Actuator code	CRA-30R	CRA-25R
Model	Buzzer	
	Flat Ø30	Flat Ø25
Appearance		
Actuator code	CRB-30	CRB-25

Accessories

Model	Emergency protection cover		Front protective cover		Silicone cover		Tightening tool		
	HEG-25 (Protrusion)	HEG-30 (Protrusion)	HSC-25P (Protrusion)	HSC-30P (Protrusion)	CR-25WPC	CR-30WPC	FIX HEAD-CR25	FIX HEAD-CR30	FIX HANDLE
Application Model	CRE-25, CRA-25	CRE-30, CRA-30	CRF-F25, CRX-F25	CRF-F30, CRX-F30	Ø25	Ø30	Ø25	Ø30	Handle
Appearance									





























Suffix Code

Model	Code	Content
CRF -	□	Push button switch
CRX -	□	Illuminated pushbutton switch
CRP -	□	Indicator light
CRS -	□	Selector short lever switch
CRSL -	□	Selector long lever switch
CRT -	□	Illuminated selector switch
CRTL -	□	Illuminated long lever switch
CRK -	□	Key selector switch
CRE -	□	Emergency stop switch
CRA -	□	Illuminated emergency stop switch
CRB-	□	Buzzer
Control part shape	F30	Ø30 Flat
	P30	Ø30 Protrusion
	G30	Ø30 Protective guard
	F25	Ø25 Flat
	P25	Ø25 Protrusion
	G25	Ø25 Protective guard

Specification

Contact configuration	1a1b	
Contact operation	Slow-make	
Installation panel thickness	1 ~ 6 mm (excluding accessories)	
Rated voltage / power consumption	100-240 V a.c. / 4.4 VA or less	
	380 V a.c. / 2.7 VA or less	
Allowable operating frequency	Mechanical	30 times/min or less
	Electrical	30 times/min or less
Insulation Resistance	100MΩ or more	
Withstand voltage	1500 V a.c. 50/60 Hz 1 minute	
Vibration resistance	Malfunction	10-55 Hz double amplitude width 3 mm
Shock resistance	Mechanical	500 m/s ² or more
	Malfunction	100 m/s ² or more
life	Mechanical	10,000 times or more
	Electrical	100,000 times or more
Ambient temperature and humidity	-25 ~ 40 °C, 45 ~ 85 % RH	
Storage temperature	-40 ~ 60°C	
Certification		

MR series

Model	Push button switch					
	Aluminum guard			Plastic guard		
	Flat Ø30	Flat Ø25	Protrusion Ø22	Flat Ø25	Protrusion Ø22	
Appearance						
Actuator code	MRF-A(Ø30)	MRF-N(Ø25)	MRF-R(Ø22)	MRF-K(Ø25)	MRF-T(Ø22)	
Model	Illuminated pushbutton switch					
	Aluminum guard			Plastic guard		
	Flat Ø30	Flat Ø25	Protrusion Ø22	Flat Ø25	Protrusion Ø22	ON / OFF
Appearance						
Actuator code	MRX-A(Ø30)	MRX-N(Ø25)	MRX-R(Ø22)	MRX-K(Ø25)	MRX-T(Ø22)	MRX-WM2
Model	Indicator light					
	Aluminum guard			Plastic guard		
	Flat Ø30	Flat Ø25	Protrusion Ø22	Flat Ø25	Protrusion Ø22	
Appearance						
Actuator code	MRP-A(Ø30)	MRP-N(Ø25)	MRP-R(Ø22)	MRP-K(Ø25)	MRP-T(Ø22)	
Model	Selector switch					
	Aluminum guard			Plastic guard		
	Flat Ø30	Flat Ø25	Protrusion Ø22	Flat Ø25	Protrusion Ø22	
Appearance						
Actuator code	MRS-A(Ø30)	MRS-N(Ø25)	MRS-R(Ø22)	MRS-K(Ø25)	MRS-T(Ø22)	
Model	Illuminated selector switch					
	Aluminum guard			Plastic guard		
	Flat Ø30	Flat Ø25	Protrusion Ø22	Flat Ø25	Protrusion Ø22	
Appearance						
Actuator code	MRT-A(Ø30)	MRT-N(Ø25)	MRT-R(Ø22)	MRT-K(Ø25)	MRT-T(Ø22)	
Appearance						
Actuator code	MRT-A3(Ø30)	MRT-N3(Ø25)	MRT-R3(Ø22)	MRT-K3(Ø25)	MRT-T3(Ø22)	
Model	Key selector switch					
	Aluminum guard					
	Flat Ø30	Flat Ø25	Protrusion Ø22			
Appearance						
Actuator code	MRK-A(Ø30)	MRK-N(Ø25)	MRK-R(Ø22)			

New product
Control switch

High-end
Control switch

New product
assembly
Indicator light
Rectangular
indicator light

Power switch
Main switch

Cam switch

Limit
switch

Micro
switch

Foot switch
Mono lever
switch

Hoist
switch

CONTROL SWITCHES

Model	Emergency stop switch				
	Aluminum guard			Plastic guard	
	Flat Ø30	Flat Ø25	Protrusion Ø22	Flat Ø25	Protrusion Ø22
Appearance					
Actuator code	MRE-AM(Ø30)	MRE-NM(Ø25)	MRE-RM(Ø22)	MRE-KM(Ø25)	MRE-TM(Ø22)
Appearance					
Actuator code	MRE-AR(Ø30)	MRE-NR(Ø25)	MRE-RR(Ø22)	MRE-KR(Ø25)	MRE-TR(Ø22)
Model	Illuminated emergency stop switch				
	Aluminum guard			Plastic guard	
	Flat Ø30	Flat Ø25	Protrusion Ø22	Flat Ø25	Protrusion Ø22
Appearance					
Actuator code	MRA-AM(Ø30)	MRA-NM(Ø25)	MRA-RM(Ø22)	MRA-KM(Ø25)	MRA-TM(Ø22)
Appearance					
Actuator code	MRA-AR(Ø30)	MRA-NR(Ø25)	MRA-RR(Ø22)	MRA-KR(Ø25)	MRA-TR(Ø22)
Model	Buzzer				
	Aluminum guard			Plastic guard	
	Flat Ø30	Flat Ø25	Protrusion Ø22	Flat Ø25	Protrusion Ø22
Appearance					
Actuator code	MRB-A(Ø30)	MRB-N(Ø25)	MRB-R(Ø22)	MRB-K(Ø25)	MRB-T(Ø22)

Accessories

Model	Emergency sign nameplate		Emergency protection cover			Front protective cover			Tightening tool	
	EN-36	EN-26	HEG-22 (Protrusion)	HEG-25F (Flat)	HEG-30F (Flat)	HSC-22P (Protrusion)	HSC-25F (Flat)	HSC-30F (Flat)	FIX HEAD-MR	FIX HANDLE
Application Model	MRE-A MRA-A	MRE-R, MRE-T MRA-R, MRA-T	MRE-R, MRE-T MRA-R, MRA-T	MRE-N, MRE-K MRA-N, MRA-K	MRE-A, MRA-A	MRF-R, MRF-T MRX-R, MRX-T	MRF-N, MRF-K MRX-N, MRX-K	MRF-A, MRX-A	Ø22, Ø25, Ø30	Handle
Appearance										

Suffix Code

Model	Code	Content
MRF -	□	Push button switch
MRX -	□	Illuminated pushbutton switch
MRP -	□	Indicator light
MRS -	□	Selector switch
MRT -	□	Illuminated selector switch
MRK -	□	Key selector switch
MRE -	□	Emergency stop switch
MRA -	□	Illuminated emergency stop switch
MRB-	□	Buzzer
Control part shape	A	Ø30 flat
	N	Ø25 flat
	R	Ø22 protrusion
	K	Ø25 flat
	T	Ø22 protrusion
		Aluminum guard
		Plastic guard

Specification

Contact unit	MR-CB	
Contact configuration	1a1b	
Contact operation	Snap-action	
Installation panel thickness	7.0 mm (excluding accessories)	
Mechanical	Tightening torque	Mounting nut : 1.96 N·m max Terminal bolt : 0.78 N·m max
	Operating distance	5 mm ±0.2
	Recoil time	3 ms or less
	Operating part operation life	Button : more than 500,000 times, Selector : more than 200,000 times
Electrical	Withstand voltage	2,000 V a.c. 50/60 Hz 1 minute
	Contact contact resistance	50 mΩ or less (at the time of shipment)
	Insulation Resistance	100 MΩ or more 500 V d.c.
	Rated current	6 A 250 V a.c.
	Minimum load current	5 mA 24 V d.c., 10 mA 11 V d.c.
Light source	Electrical life	More than 200,000 times
	Power supply voltage	100-240 V a.c. (LED capacitor voltage drop type) 380 V a.c. (LED capacitor voltage drop type) 12-24 V a.c. 50/60Hz or 12-24 V d.c. (LED capacitor voltage drop type)
Environmental conditions	Ambient temperature and humidity	-20 ~ 55 °C, 35 ~ 85 % RH (Without condensation)
	Storage temperature	-40 ~ 85 °C
	Shock resistance	300 pulse period 11 ms
	Vibration resistance	100, 10 Hz-55 Hz, amplitude 0.75 mm (within 1 ms)

AR series



Product composition

Model	Push button switch		Illuminated pushbutton switch		Indicator light	
	Columnar	Columnar	Columnar	ON / OFF	AC	DC
Appearance						
Actuator code	ARF-F,B,P,G,H	ARF-S	ARX-P,G,H	ARX-S	ARP-A0	ARP-D0
Model	Selector switch	Illuminated selector switch	Key selector switch	Emergency stop switch		
	Lever	Lever				
Appearance						
Actuator code	ARS-S,L	ART-2,2R,3	ARK-2,2R,3,3L,3R,3LR	ARE-3,4	ARE-4XR	

New product
Control switch

High-end
Control switch

New product
assembly
Indicator light
Rectangular
indicator light

Power switch
Main switch

Cam switch

Limit
switch

Micro
switch

Foot switch
Mono lever
switch

Hoist
switch

Suffix code

Model	Code	Content
ARF -	<input type="checkbox"/>	Push button switch
ARX -	<input type="checkbox"/>	Illuminated pushbutton switch
ARP -	<input type="checkbox"/>	Indicator light
ARS -	<input type="checkbox"/>	Selector switch
ART -	<input type="checkbox"/>	Illuminated selector switch
ARK -	<input type="checkbox"/>	Key selector switch
ARE -	<input type="checkbox"/>	Emergency stop switch
ARE -	<input type="checkbox"/>	Illuminated emergency stop switch
ARB-	<input type="checkbox"/>	Buzzer

Specification

Allowable operating frequency	Mechanical	30 times/minute
	Electrical	30 times/minute
Insulation Resistance		100 MΩ or more
Withstand voltage		2,000 V a.c. 1 minute (between the same pole terminals)
Vibration resistance	Malfuction	10-55 Hz double amplitude 3 mm (within 1 ms)
Shock resistance	Mechanical	500 m/s or more
	Malfuction	100 m/s or more
Life	Mechanical	1,000,000 times or more
	Electrical	100,000 times or more
Light source	Power supply voltage	100-240 V a.c. (LED capacitor voltage drop expression)
		12-24 V a.c./d.c. (LED capacitor voltage drop expression)
Ambient temperature & humidity		-25 ~ 40 °C, 45 ~ 85 % RH (Without condention)
Storage temperature		-40 ~ 70°C

Accessories

Model	Emergency sign nameplate	Emergency Protection Cover	Tightening tool	
	EN-26	HEG-22(Extended)	FIX HEAD-AR	FIX HANDLE
Applied model	ARE	ARE	All models	Handle
Appearance				

COMBINATION DISPLAY LIGHT

CDN series

NEW

Specification

Model	CDN		
Appearance			
Power Voltage	24 V a.c. 50/60 Hz or 24 V d.c.	110 V a.c.	220 V a.c.
LED Indication Color	Red, green, yellow, white, orange, blue		
Insulation resistance	100 MΩ or more		
Voltage withstand	2,000 V a.c. 1 minute		
Power consumption	20 mA 0.4 VA	0.4 W	0.5 W
LED Rated Voltage	24 V d.c.		
Life	50,000 hours (24 V d.c., 25 °C)		
Ambient temperature and humidity	-20 °C ~ 40 °C, 45 ~ 85 % RH (Without condention)		
Storage temperature	-25 ~ 55 °C		

(Note) CDN-S□ (30 X 30 mm) / CDN-R□ (30 X 40 mm)

Suffix code

Model	Code				Content	
CDN-	□	□	-□□	□□	-□□□□□□	Set Indicator
Basic model name	S					Square (30×30 mm)
	R					Rectangle(30×40 mm)
Power Voltage	D2					24 V a.c. 50/60 Hz or 24 V d.c.
	A1					110 V a.c.
	A2					220 V a.c.
Collective Face Configuration Group		01				1st to 10th
Collective Face Configuration Column			01			Rows 1 to 20
Lamp color					C	C : COLOR color combination R (Red), G (Green), Y (Yellow), O (Orange), A (Blue), W (White)

CR40 series

Specifications





Model	CR40		
Appearance			
Power Voltage	100-240 V a.c.	380 V a.c.	12-24 V a.c./d.c.
Power consumption/current	4.4 VA or less	2.7 VA or less	18 mA or less
Display color	Red, green, yellow, blue, white		
Light source life	100,000 h		

Suffix code

Model	Code	Content	
CR40	□ □	LED light source rectangular indicator	
Power Voltage	A0	100-240 V a.c.	LED (Condenser voltage drop type)
	A3	380 V a.c.	
	D0	12-24 V a.c./d.c.	LED (Resistance voltage drop type)
Display color	R	Red, green, yellow, blue, white	

HY-500 series

Product composition

Model	Rated capacity	Use
 Exposed HY-510 3P 250 V a.c. 15A Electromotor 3 phase power supply ON, OFF		
 Recessed HY-512, HY-512S (Switch part for the lamp) HY-513, HY-513S (Switch part for the lamp) HY-514 3P 250 V a.c. 15A Electromotor for 3 phase power supply ON, OFF Electromotor for 3 phase power supply ON, OFF	2P 250 V a.c. 15A 1 Phase Electromotor ON, OFF	
	3P 250 V a.c. 15A	
	3P 250 V a.c. 15A	
 Exposed HY-516 3P 250 V a.c. 15A Electromotor for 3 phase power supply Direct/reverse revolution for stop 1 phase, 3 phase, right/left for revolution		
 Exposed HY-517 3P 250 V a.c. 15A Electromotor 1 phase, 3 phase ON, OFF		



New product Control switch
High-end Control switch
New product assembly Indicator light Rectangular indicator light
Power switch Main switch
Cam switch
Limit switch
Micro switch
Foot switch Mono lever switch
Hoist switch

BE series

● Steel case (BE)

Model	Rated capacity	Contact terminal	Marker	Case material
 Steel case exposed BE 230 3P 440 V a.c. 30A M5 ON (Black) OFF (Red) Cold workable steel plate				

● Waterproof type (BEW, BEWT)

Model	Rated capacity	Contact terminal	Marker	Case material
 Waterproof BEW 215 3P 440 V a.c. 15A M4 ON (Black) OFF (Red)	BEW 230 3P 440 V a.c. 30A M5			Flame retardant ABS resin
	 Advanced waterproof type BEWT 215 3P 440 V a.c. 15A M4			
 Advanced waterproof type BEWT 315 3P 440 V a.c. 15A M4 FOR. (Black) STOP (Red) REV. (Black)				

MAIN / CAM SWITCHES

MAS series

Specifications

Appearance	Suffix code	Rated insulation voltage	Rated conduction current
	MAS-025-A/B	690 V a.c.	25 A
	MAS-063-A/B		63 A
	MAS-125-A/B		125 A

Suffix code

Model	Code	Content
MAS-	<input type="checkbox"/> <input type="checkbox"/>	Main switch
Rated current	025	For AC25 A
	063	For AC63 A
	125	For AC125 A
Color classification	A	For emergency stop (yellow guard, red handle)
	B	Basic type (white guard, black handle)

SQ4 series

Specifications

Model	SQ4	
Appearance		
Rated insulation voltage (Ui)	690 V a.c.	
Impulse withstand voltage (Uimp)	2,500 V a.c.	
Rated conduction current (Ith)	16 A	
Rated conduction current (Ie)	16A-24 V a.c. / 8A-48 V a.c. / 5A-110 V a.c. / 3A-220 V a.c. / 1.8A-380 V a.c.	
Rated operating voltage (Ue)	480 V a.c.	
Mechanical life	300,000 Times	
Electrical life	AC: 200,000 Times, DC: 100,000 Times	
Ambient temperature & humidity	-25 ~ 55 °C, less than 90% RH (however, there should be no condensation)	
Altitude	2,000 m or less	
Material for each part	Body	NY66 GF15 % flame retardant grade
	Cam	ACETAL
	Contact	AgNi
	Terminal	BRASS
	Bolt	Iron (galvanized)
	Spring	Stainless (STS)
	Handle	PC flame retardant grade





Suffix code

Model	Code	Content
SQ4-	<input type="checkbox"/> <input type="checkbox"/> <input type="checkbox"/> <input type="checkbox"/> <input type="checkbox"/> <input type="checkbox"/> <input type="checkbox"/> <input type="checkbox"/>	Cam switch
install	F	4-Hole panel mounting
Nameplate frame	S	Square nameplate frame (48 X 48 mm)
Handle	H	H-type handle (general industrial)
	R	R-type handle (voltmeter, ammeter switch)
Selected number of stages	2	2nd stage selection
	3	3nd stage selection
	4	4nd stage selection
	5	5nd stage selection
	6	6nd stage selection
	7	7nd stage selection
Number of contact units stacked	1	1 Rows
	2	2 Rows
	3	3 Rows
	4	4 Rows
	5	5 Rows
	6	6 Rows
Standard circuit diagram serial number	0 1	01 ~ 99

* For standard products, refer to the individual model code. (Voltmeter, ammeter switch, etc.)

HY-SQ5/255/305/MRK series

Specifications

Model		Square type	Round type	Handle locking type	Bottom (C) type	Square key type	
Appearance							
Contact rating	Rated insulation voltage	600 V					
	Rated current	10 A, 20 A					
	Contact structure	2 Cut-off slow-make 1- stage 2 contacts, max. 6 positions (max. 3 positions for the momentary version)					
	Operation method	Each position fixed, spring return type					
	Selection angle	30°, 45°, 60°, 90°					
	Positions	2 positions ~ 12 positions, 2 positions ~ 4 positions					
	Insulation resistance	100 MΩ (500 V d.c.)					
	Life	Dielectric strength	2,500 V a.c. for 1 min				
		Mechanical	Min. 500 thousand operations				
		Electrical	● Min. 100 thousand operations, ● MRK : Min. 200 thousand operations				
	Ambient temperature	-20 ~ 50 °C					
	Degree of protection	● 305, 255 (Round type) : IP65 (IEC 60529), ● SQ5 (Square type) : IP40 (IEC 60529)					
Part materials	Body	Heat-resistant Polycarbonate (PC)					
	Cam	Acetal					
	Contacts	Ag + Ni					
	Terminals	Brass					
	Bolt	Swrm					
	Springs	Stainless Steel					
	Handle	Phenol Resin					

New product
Control switch

High-end
Control switch

New product
assembly
indicator light
Rectangular
indicator light

Power switch
Main switch

Cam switch

Limit
switch

Micro
switch

Foot switch
Mono lever
switch

Hoist
switch

Suffix code

Model	Code						Content
Appearance	<input type="checkbox"/>	<input type="checkbox"/>	<input type="checkbox"/>	<input type="checkbox"/>	<input type="checkbox"/>	<input type="checkbox"/>	Cam switch
	HY-SQ5						Square type cam switch
	HY-255						Ø25 type cam switch
	HY-305						Ø30type cam switch
Contact type	S						Square type (standard type)
	C						Round type (for HY-SQ5)
Handle type	H						Standard type (standard industrial machine)
	R						Switch board type (A/S, V/S)
	P						Control switch type (C/S)
Position selection	2						2 positions
	3						3 positions
	4						4 positions
	5						5 positions
	6						6 positions
Number of contact unit (Number of rows)	1						1 rows
	2						2 rows
	3						3 rows
	4						4 rows
	5						5 rows
	6						6 rows
Standard circuit diagram serial number	0	1					01 ~ 99









※ A/S : ammeter converting switch, V/S: voltmeter converting switch
 ※ Possible to manufacture 20 A, 250 V product only within the square type contact structure

Suffix code

Model	Code				Content
HY-MRK	4	2	0	2	Key cam switch
Contact formation					Labeled the serial number (refer to the standard circuit diagram)

LIMIT SWITCHES









HY-M900/LM900 series

Model	Roller plunger		Top ball plunger		Variable roller		Variable rod wire		Roller lever		Coil spring		Ø50 roller lever	Fork roller Lever
	HY-M902	HY-LM902	HY-M903	HY-LM903	HY-M904	HY-LM904	HY-M907	HY-LM907	HY-M908	HY-LM908	HY-M909	HY-LM909	HY-M908R	HY-M908L
Appearance														
Operation speed	0.1 - 1 m/s													
Opening and closing frequency	Mechanical	120 times/minute												
	Electrical	20 times/minute												
Insulation resistance	100 MΩ or more (500 V d.c.)													
Dielectric strength	● 1000 V a.c. 50/60 Hz for 1 min (between charging part), ● 1500 V a.c. 50/60 Hz for 1 min (between discharging part)													
Contact resistance	Max. 100 MΩ (initial)													
Vibration	Malfuction	10 - 55 Hz double amplitude width 1.5 mm												
Shock	Mechanical	1,000 m/s or more (100G or more)												
	Malfuction	300m/s or more (30G or more)												
Life	Mechanical	More than 1 million times												
	Electrical	More than 300,000 times												

● Rating

Rated voltage(V)		Non-inductive load (A)				Inductive load (A)			
		Resistive load		Lamp		Inductive load		Electric motor load	
		NC	NO	NC	NO	NC	NO	NC	NO
AC	125	15		3	1.5	10		3	1.5
	250	10		2	1	6		2	1
	480	3		1.5	0.8	2		1.5	0.75
DC	8	15		6	3	10		-	-
	14	15		6	3	10		-	-
	30	6		4	3	5		-	-
	125	0.4		0.2	0.2	0.05		-	-
	250	0.2		0.1	0.1	0.03		-	-

HY-L800 series

Model	Roller Plunger [horizontal]	Cross roller Plunger type [vertical]	Top Plunger	Roller Adjustable Lever	Rubber Roller Adjustable Lever	Adjustable Rod Lever	Roller Lever	Coil spring
	HY-L802	HY-L802C	HY-L803	HY-L804	HY-L804RE	HY-L807	HY-L808	HY-L809
Appearance								
Frequency	Mechanical	120 times/minute						
	Electrical	30 times/minute						
Insulation resistance	100 MΩ 이상 (500 V d.c.)							
Dielectric strength	● Between terminals: 1,500 V a.c. 50/60 Hz 1 minute, ● Between non-charging metal parts: 2,000 V a.c. 50/60 Hz 1 minute							
Contact resistance	25 MΩ or less (initial value), 100 MΩ or less (after test)							
Vibration	Malfuction	10-55 Hz or more, double amplitude 1.5 mm						
Shock	Mechanical	300m/s or more (30G or more)						
	Malfuction	100m/s or more (10G or more)						
Life	Mechanical	Over 1 million times (open/close frequency 120 times/min)						
	Electrical	100,000 times or more (opening and closing frequency 20 times/min at rated load)						
Ambient temperature & humidity	-10 ~ 70 °C, 95% RH or less (20 °C) (No condensation)							

● Rating

Rated voltage	LOAD	Resistive load (cosφ≠1)	Inductive load (cosφ=0.4)
	125 V a.c.		5 A
250 V a.c.		5 A	2 A
125 V d.c.		0.4 A	0.1 A

HY-LS800 series



Model		Roller Plunger	Push Plunger	Roller Arm	Rubber Roller Lever	Roller Adjustable Lever	Adjustable Rod Lever	Roller Lever
		HY-LS802N	HY-LS803N	HY-LS803RN	HY-LS804RE	HY-LS804N	HY-LS807N	HY-LS808N
Appearance								
Frequency	Mechanical	120 times/minute						
	Electrical	30 times/minute						
Insulation resistance		100 MΩ or more (500 V d.c.)						
Contact resistance		25 MΩ or less (initial value)						
Dielectric resistance		● 1,000 V a.c. 50/60 Hz for 1 minute, ● 2,000 V a.c. 50/60 Hz 1 minute						
Vibration	Malfunction	10-55 Hz double amplitude 1.5 mm						
Shock	Mechanical	1000 m/s ² or more (100 G or more)						
	Malfunction	300 m/s ² or more (30 G or more)						
Life	Mechanical	More than 1 million times						
	Electrical	100,000 times or more						
Ambient temperature and humidity		-10 ~ 70 °C, 95 % RH or less (20 °C) (No condensation)						

● Ratings

Rated voltage (V)		Non-inductive load (A)			Inductive load (A)			
		Resistive load		Lamp	Inductive load		Electric motor load	
		NO	NC	NC	NO	NC	NO	NC
AC	125	6	2		6		3	
	250	6	1.5		6		1.5	
DC	8	6	4		6		4	
	14	6	4		6		4	
	30	4	2.5		4		2.5	
	125	0.4	0.1		0.4		0.1	
	250	0.2	0.05		0.2		0.05	

ZCN-500 series



Model		Plunger	Hinge roller short lever	Hinge roller long lever	Hinge short lever	Hinge lever	Hinge long lever	Vertical roller plunger	Horizontal roller plunger	Resin road spring
		ZCN-P5010	ZCN-R504A	ZCN-R504C	ZCN-L507A	ZCN-L507C	ZCN-L507D	ZCN-PR508V	ZCN-PR508H	ZCN-L509
Appearance										
Operation speed		0.1 mm - 0.5 m/s								
Frequency	Mechanical	120 times/minute								
	Electrical	20 times/minute								
Insulation resistance		100 MΩ or more (500 V d.c.)								
Contact resistance		25 MΩ or less (initial value), 100 MΩ or less								
Dielectric strength		● Between charging part : 1000 V a.c. 50/60 Hz for 1 min, ● between discharging part : 1500 V a.c. 50/60 Hz for 1 min								
Vibration	Malfunction	10-55 Hz double amplitude 1.5 mm								
Shock	Mechanical	1000 m/s ² or more (100 G or more)								
	Malfunction	300 m/s ² or more (30 G or more)								
Life	Mechanical	More than 1 million times								
	Electrical	More than 300,000 times								
Ambient temperature and humidity		-10 ~ 80 °C 25 ~ 95 % RH (No condensation)								

● Ratings

Rated voltage(V)		Non-inductive load(A)		Inductive load ((A)			
		Resistive load		Inductive load		Electric motor load	
		NC	NO	NC	NO	NC	NO
AC	125	15		10		3	1.5
	250	10		6		2	1
	600	3		2		1.5	0.75
DC	8	15		10		-	-
	14	15		10		-	-
	30	6		5		-	-
	125	0.4		0.05		-	-
	250	0.2		0.03		-	-

New product
Control switch

High-end
Control switch

New product
assembly
Indicator light
Rectangular
indicator light

Power switch
Main switch

Cam switch

Limit
switch

Micro
switch

Foot switch
Mono lever
switch

Hoist
switch

MICRO SWITCHES

HY-700 series







Specifications

Model	Panel mounting	Spring single push button	Pin push button	Spring stander push button	Hinge roller single lever
	HY-P701A (Z4G1P05B)	HY-P701B (Z4G1P09B)	HY-P701C (Z4G1P01B)	HY-P701D (Z4G1P03B)	HY-R704A (Z4G1L07B)
Appearance					
Model	Hinge roller middle lever	Hinge roller lever	2 positions roller lever	Single position lever	Middle lever type
	HY-R704B	HY-R704C (Z4G1L03B)	HY-R704-2W	HY-L707A	HY-L707B
Appearance					
Model	Hinge lever	Special lever	Hinge special lever	Roller panel mounting (Vertical)	Roller panel mounting (horizontal)
	HY-L707C (Z4G1L01B)	HY-L707D	HY-L707S	HY-PR708A	HY-PR708B (Z4G1P07B)
Appearance					
Operation speed		0.1 mm - 1 m/s			
Allowable operating frequency	Mechanical	50 - 300 times/minute			
	Electrical	20 times/minute			
Insulation resistance		100 MΩ or more (500 V d.c.)			
Contact resistance		● Max. 50 MΩ (initial), ● max. 2 Ω (after testing)			
Vibration resistance		10 - 55 Hz double amplitude 0.75mm			
Shock resistance	Mechanical	1,000 m/s ² or more (100G or more)			
	Malfunction	300m/s ² or more (30G or more)			
Dielectric strength		2,000 V a.c. 50/60 Hz 1 minute (each terminal and non-charging metal part)			
Life	Mechanical	Over 1 million times (open/close frequency 120 times/min)			
	Electrical	300,000 times or more (opening and closing frequency 20 times/min at rated load)			
Net weight(g)		31.5 ~ 59.5 g			
Rated current (Ie)		10 A 250 V a.c. (Resistive load)			

HY-100 series

Specifications

Model	HY-101	HY-102N
Appearance		
Rated voltage	250 V a.c., 10 A	250 V a.c., 10 A
Internal switch	SMV-61A-07H	SMV-61A-07H
Material of case	Plastic	Aluminum



Model	HY-103N	HY-104N	HY-105N
Appearance			
Rated voltage		250 V a.c., 10 A	
Internal switch	HY-P701B	HY-P701D	HY-P701B
Material of case	Aluminum	Aluminum green (Hammer) stamp	

Suffix code

Model	Code	Content
HY-10	<input type="checkbox"/>	Foot Switch
Appearance	1	Plastic foot switch
	2N	Aluminum foot switch
	3N	Middle size aluminum foot switch
	4	Large size aluminum foot switch
	5	Large size aluminum foot switch

LEL/LES series

Specifications

Model	LEL (Long lever)	LES (Short lever)
Appearance		
Rated insulation voltage	600 V	
Rated current	3 A 250 V a.c.	
Contact structure	2 Cut-off slow-make 1- stage 2 contacts, max. 4 positions	
Insulation resistance	100 MΩ (500 V d.c.)	
Dielectric strength	2,500 V a.c., for 1 min (between charging part and discharging part)	
Contact resistance	20 mΩ or less (at the time of shipment)	
Life	● Mechanical : Min. 500 thousand operations, ● Electrical : Min. 100 thousand operations	
Ambient temperature & humidity	-20 ~ 50 °C, 45 ~ 85 % RH (without condensation)	

Suffix code

Model	Code	Content
LE	<input type="checkbox"/> <input type="checkbox"/> <input type="checkbox"/>	Mono Lever Switch
Lever selection	L	Long lever
	S	Short lever
Stage selection	01	1 st step selection
	02	2 st step selection
	03	3 st step selection
	04	4 st step selection
Returning type	1	Auto returning
	2	Manual returning

※ In the case of the combination return type, it is an order product, so please enter the return operation for each direction. The basic contact configuration for each direction of the product is 1a.

New product
Control switch

High-end
Control switch

New product
assembly
indicator light
Rectangular
indicator light

Power switch
Main switch

Cam switch

Limit
switch

Micro
switch

Foot switch
Mono lever
switch

Hoist
switch

HOIST SWITCHES

HY-P series



Specifications



Model	HY-P1022B	HY-P1024BB HY-P1022SB	HY-P1026BBB HY-P1024SBB	HY-P1026SB	HY-P1028BBBB HY-P1028SBBBB	HY-P1029SBBB
	2 button	4 button/2 button +Push lock turn reset	6 button/4 button +Push lock turn reset	6 button/push lock turn reset +1 (switch)	8 button/push lock turn reset +1 (switch)	6 button/push lock turn reset + 3 (switch)
Degree of protection	IP65 (IEC 60529)					
Materials · Colors	Case	High impact ABS resin				
	Contacts	AgSnO2				
Insulation resistance	100 MΩ (500 V d.c.)					
Dielectric strength	2,000 V a.c. 1 minute (between charging and non-charging parts)					
Ambient temperature & humidity	-10 ~ 45 °C, 45 ~ 85 % RH (without condensation)					

Suffix code





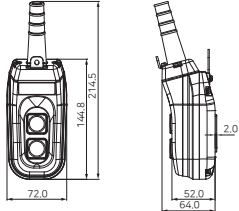

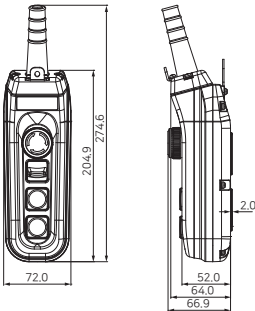



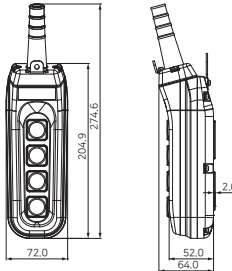

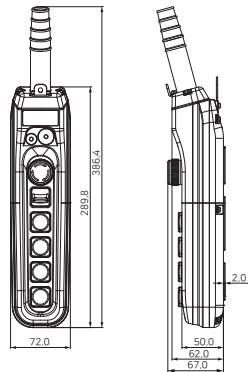
Model	Code								Content		
HY-	<input type="checkbox"/>	<input type="checkbox"/>	<input type="checkbox"/>	<input type="checkbox"/>	<input type="checkbox"/>	<input type="checkbox"/>	<input type="checkbox"/>	<input type="checkbox"/>	Hoist switch		
Number of buttons	P1022	X	X	X	X	X	X	X	2 buttons		
	P1024	X	X	X	X	X	X	X	4 buttons		
	P1026	X	X	X	X	X	X	X	6 buttons		
	P1028	X	X	X	X	X	X	X	8 buttons		
	P1029	X	X	X	X	X	X	X	9 buttons		
Emergency switch									None		
	S									1b Basic specifications	
	S1									1a1b Contacts on-demand	
Contacts and control switches									None		
	P	P	P						MRP-RA0	MR control switches * Arrangement order and type may vary according to order specifications. * There are 6 types of nameplates when selecting a control switch. (POWER, MAIN-AUX, OFF ON, HORN, LIGHT, A+A+B B) * If you do not select it, it will be shipped without a nameplate.	
	H	H	H						MRF-RM1		
	M	M	M						MRS-R2A1		
	Y	Y	Y						MRS-R3A2		
	K	K	K						MRK-R2A1		
				A	A	A	A	HY-PA		1a	Default
				B	B	B	B	HY-PB		1a-1a	
				C	C	C	C	HY-PC		1a-1a	
				D	D	D	D	HY-PD		2a-2a	
				E	E	E	E	HY-PE		2a-2a	
				A1	A1	A1	A1	HY-PA1		1a1b	
				B1	B1	B1	B1	HY-PB1		1a1b-1a1b	
			C1	C1	C1	C1	HY-PC1		1a1b-1a1b		
			E1	E1	E1	E1	HY-PE1		2a2b-2a2b		
			F	F	F	F	HY-PF		2a		
			F1	F1	F1	F1	HY-PF1		2a2b		
Other	Toggle switch and volume required by consumers, etc. Separate order available for mounting other options								Toggle switch (2rd 3rd)		
									Volume 1K,2K,3K,Etc		
									Ø 8~16 controller switches		

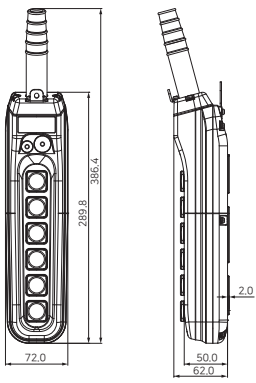
※ Except where X is indicated in the model configuration

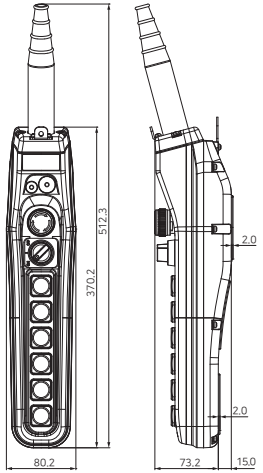
External dimensions

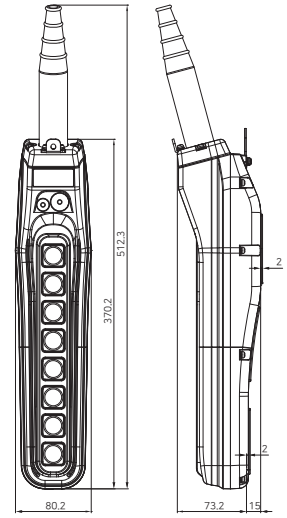
Model	Appearance	External dimensions	Model	Appearance	External dimensions
HY-P1022 2 button			HY-P1022S 2 button +Push lock turn reset		

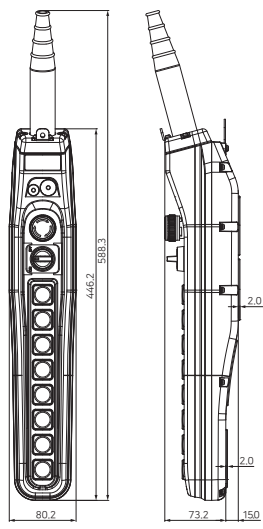

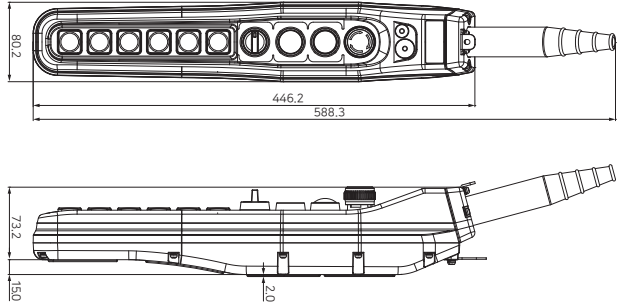





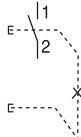
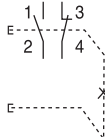

External dimensions

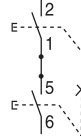
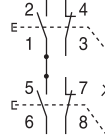
Model	Appearance	External dimensions	Model	Appearance	External dimensions
HY-P1024 4 button			HY-P1024S 4 button +Push lock turn reset		
HY-1026 6 button			HY-1026S 6 button + 1 switch +Push lock turn reset		
HY-P1028 8 button			HY-P1028S 8 button + 1 switch +Push lock turn reset		
Model	Appearance	External dimensions			
HY-P1029S 6 button+ 3 switch +Push lock turn reset					

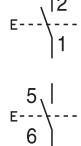
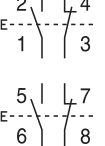

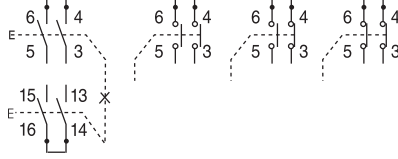
- New product
Control switch
- High-end
Control switch
- New product
assembly
Indicator light
Rectangular
indicator light
- Power switch
Main switch
- Cam switch
- Limit
switch
- Micro
switch
- Foot switch
Mono lever
switch
- Hoist
switch

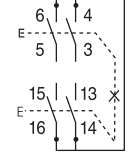
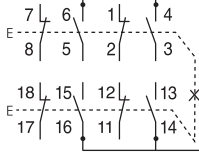
HOIST SWITCHES

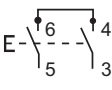
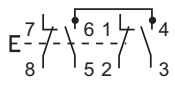
Contact units

Model	Appearance	Contact configuration		Information
HY-PA		HY-PA(1a) 	HY-PA1(1a1b) 	For on/off operation power, etc. To close and hold, press the top button (ON) . To open, press the bottom button (OFF).
HY-PB		HY-PB(1a-1a) 	HY-PB1(1a1b-1a1b) 	For general circuits (up/down/east/west, etc.) It does not support the simultaneous operation of the 2 buttons with the seesaw-type mechanical interlock.
HY-PC		HY-PC(1a-1a) 	HY-PC1(1a1b-1a1b) 	For general circuits. It supports the simultaneous operation of the 2 buttons because there is no mechanical interlock.
HY-PD		HY-PD(2a-2a) 		For speed control and 2-circuit control The contacts are divided into two stages. It does not support the simultaneous operation of the 2 buttons with the seesaw-type mechanical interlock.
HY-PE		HY-PE(2a-2a) 	HY-PE1(2a2b-2a2b) 	For general circuits. 2a-2a / 2a2b-2a2b contacts. It does not support the simultaneous operation of the 2 buttons with the seesaw-type mechanical interlock.
HY-PF		HY-PF(2a) 	HY-PF1(2a2b) 	For general circuits. You can freely assemble and configure it according to the independent 1 contact switch. Up to 2a2b contacts (1a, 1b, 1a1b, 2a1b, 2a2b)

Contact units (Push lock turn reset switch)



Model	Appearance	Contact configuration		Explanation
HY-PS		HY-PS 	HY-PS1 	When the button is pressed, the pressed state is maintained. Return turns in the direction of the printed arrow. (Moving part + contact)

Accessories

Model	Appearance	Explanation
PS-3R(HOIST)		Switch on operation part (excluding contact)



STS series

Specifications

Model	STS 040	STS 060	STS 080
Appearance			
Circumference size	Ø 40	Ø 60	Ø 80
Bracket selection	<ul style="list-style-type: none"> ● Plastic round bracket ● L type bracket ● Elbow bracket (option) 	<ul style="list-style-type: none"> ● Plastic round bracket ● L type bracket ● Elbow bracket (option) 	<ul style="list-style-type: none"> ● Plastic round bracket ● L type bracket ● Elbow bracket (option)
Rated voltage	24 V a.c. 50/60 Hz or 24 V d.c. (Order specification when the power supply voltage is 12 V)		
Number of stacked layers	1, 2, 3, 4, 5 stacks		
Color	Red, Yellow, Green, Blue, White		
Power Consumption	Max. approx. 6 W for 5 stacks (0.9 W per each stack)		
Body material	Heat resistant ABS		

Sign Tower
Modular Sign Tower
New product Panel lamp
Wall mounting Indicator light
Rotating beacon
Warning light

Suffix code





Model	Code	Content
STS	<input type="checkbox"/> - <input type="checkbox"/> <input type="checkbox"/> <input type="checkbox"/>	Sign Tower With Continuous Light
Diameter size	040	Ø 40 cylinder type
	060	Ø 60 cylinder type
	080	Ø 80 cylinder type
Power voltage	C51	24 V a.c. 50/60 Hz or 24 V d.c.(dual usage)
	D41	12 V a.c. 50/60 Hz or 12 V d.c.(dual usage)
Number of stacked layers	1	1 stack (red)
	2	2 stack (red, green)
	3	3 stack (red, yellow, green)
	4	4 stack (red, yellow, green, blue)
	5	5 stack (red, yellow, green, blue, white)
Bracket selection	M	 PIPE connection type plastic base (MP-40, MP-60, MP-80)
	L	 L-shaped bracket
Optional		 Plastic elbowbracket (EPM-18, EPM-25)

※ The power supply voltage is 12 V a.c. 50/60 Hz or 12 V d.c. If it is, the order specification

SIGN TOWERS

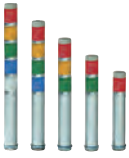
STL series





Specifications

Model	STL 025	STL 040	STL 060	STL 080
Appearance				
Circumference size	Ø 25	Ø 40	Ø 60	Ø 80
Function	Continuous light only	● A : Continuous light, ● F : Continuous light, Flashing light, Buzzer		
Rated voltage	24 V d.c.	24 V a.c. 50/60 Hz or 24 V d.c., 100-240 V a.c. 50/60 Hz		
Number of stacked layers	1, 2, 3, 4, 5 stacks			
Bracket selection	● L-shaped pedestal (ST-AG: sold separately)	● Direct installation (bolt fixed installation) ● Plastic round pedestal ● L-shaped bracket, ● STM-84 (option) ● STM-105 (option) ● Elbow type bracket (EPM) (option)		
Color	Red, Yellow, Green, Blue, White			
Power Consumption	About 4 W or less (Based on 5 stages, 0.6 W for each stage)	Max. approx. 8 W for 5 stacks (1.2 W per each lamp)		
Buzzer size	-	75 dB (1 m)	85 dB (1 m)	

Suffix code (STL025)

Model	Code	Content
STL	<input type="checkbox"/> - <input type="checkbox"/> <input type="checkbox"/> <input type="checkbox"/> <input type="checkbox"/>	Sign tower (LED light source)
Diameter size	025	Ø25 cylinder type
Power voltage	D51	24 V d.c. (LED light source)
Module colors	1	1 stack (red) ※ Color of modules can be changed at customer's request
	2	2 stack (red, green) ※ L type bracket sold separately
	3	3 stack (red, yellow, green)
	4	4 stack (red, yellow, green, blue)
	5	5 stack (red, yellow, green, blue, white)
polarity	N	NPN (Common Anode)
	P	PNP (Common Cathode)

Suffix code (STL040, 060, 080)

Model	Code	Content
STL	<input type="checkbox"/> - <input type="checkbox"/> <input type="checkbox"/> <input type="checkbox"/> <input type="checkbox"/>	Sign tower (LED light source)
Diameter size	040	Ø 40 cylinder type
	060	Ø 60 cylinder type
	080	Ø 80 cylinder type
Function	A	Continuous light only
	F	Continuous light, flashing light and buzzer (selected by the external signal)
Power voltage	C51	24 V a.c. 50/60 Hz or 24 V d.c. (dual usage)
	A11	100-240 V a.c. 50/60 Hz
Module colors	1	1 stack (red)
	2	2 stack (red, green)
	3	3 stack (red, yellow, green)
	4	4 stack (red, yellow green, blue)
	5	5 stack (red, yellow, green, blue, white)
Bracket selection	D	Direct installation (bolt fixing installation)
	L	 L type bracket (standard)
	M	 PIPE Attachable plastic bracket (MP-40, MP-60, MP-80)
Optional		Optional bracket (STM)
		Plastic elbow support (EPM-18, EPM-25)

※ Composition of stacking modules: Upper side (1st stack) to the lower side.





HY-TN series

Specifications

Stage	Model	Voltage	Consumption power	Bulb	Stage	Model	Voltage	Consumption power	Bulb	Flashing
1	HY-TN-24-1 HY-TN-220-1	24 V d.c. 220 V a.c.	0.21 A 0.04 A	5 W	1	HY-TWBN-24-1 HY-TWBN-220-1	24 V d.c. 220 V a.c.	0.21 A 0.04 A	5 W	60 times/ 1 minute
2	HY-TN-24-2 HY-TN-220-2	24 V d.c. 220 V a.c.	0.42 A 0.08 A	5 W	2	HY-TWBN-24-2 HY-TWBN-220-2	24 V d.c. 220 V a.c.	0.42 A 0.08 A	5 W	
3	HY-TN-24-3 HY-TN-220-3	24 V d.c. 220 V a.c.	0.63 A 0.11 A	5 W	3	HY-TWBN-24-3 HY-TWBN-220-3	24 V d.c. 220 V a.c.	0.63 A 0.11 A	5 W	
4	HY-TN-24-4 HY-TN-220-4	24 V d.c. 220 V a.c.	0.84 A 0.14 A	5 W	4	HY-TWBN-24-4 HY-TWBN-220-4	24 V d.c. 220 V a.c.	0.84 A 0.14 A	5 W	
5	HY-TN-24-5 HY-TN-220-5	24 V d.c. 220 V a.c.	1.05 A 0.17 A	5 W	5	HY-TWBN-24-5 HY-TWBN-220-5	24 V d.c. 220 V a.c.	1.05 A 0.17 A	5 W	

Sign Tower
Modular Sign Tower
New product Panel lamp
Wall mounting Indicator light
Rotating beacon
Warning light

Suffix code

Model	Code	Content
HY-	<input type="checkbox"/> <input type="checkbox"/> <input type="checkbox"/> <input type="checkbox"/>	HY-TN Series Sign Tower
Function	TN	Continuous light only
	TWBN:	Continuous light, flashing light, buzzer
Power voltage	24	24 V d.c.
	220	220 V a.c.
Stacking modules	1	1 stack (red)
	2	2 stack (red, green)
	3	3 stack (red, yellow, green)
	4	4 stack (red, yellow, green, blue)
	5	5 stack (red, yellow, green, blue, white)
Supporter selection		No indication (L type bracket standard)
Accessories		ST-011 (Plastic bracket installation)
		MP-60 (Plastic bracket installation (Bar type))
		EPM (Plastic elbow type bracket)

PANEL LAMP





STE060 series

Specifications





● Base unit specifications

Model	STE060-BAD51	STE060-BFD51	STE060-BAA11	STE060-BFA11	Dimension
Power voltage	24 V d.c.		100-240 V a.c. 50/60 Hz		 DC Type AC Type
Function	Lighting only	Lighting, Flickering, Buzzer (External signal)	Lighting only	Lighting, Flickering, Buzzer (External signal)	
Flickering time	-	60 times / minute	-	60 times / minute	
Buzzer sound types	-	A single melody / beeping	-	A single melody / beeping	
Size of buzzer sound	-	85 dB (1 m)	-	85 dB (1 m)	
Power Consumption	-	1.2 W	-	1.2 W	
Ambient temperature & humidity	-5 °C ~ 50 °C, 35 ~ 85 % RH (without condensation)				
Weight (g)	76 g	96 g	160 g	178 g	

● LED unit specifications

Model	STE060-LR	STE060-LY	STE060-LG	STE060-LB	STE060-LW
Dimension					
Power voltage	24 V d.c.				
Power Consumption	1.2 W				
Light source	LED				
Emission angle	360 °				
Ambient temperature & humidity	-5 °C ~ 50 °C, 35 ~ 85 % RH (without condensation)				
Weight (g)	43 g				

Suffix code

Model	Code	Content
STE060 -	<input type="checkbox"/> <input type="checkbox"/> <input type="checkbox"/> <input type="checkbox"/>	Ø60 LED Light Sign Tower
Function	A	Lighting only
	F	Lighting, Flickering, Buzzer (External signal)
Power voltage	D51	24 V d.c.
	A11	100-240 V a.c. 50/60 Hz
Stacking modules	1	1 stack (red)
	2	2 stacks (red, Green)
	3	3 stacks (red, Yellow, Green)
	4	4 stacks (red, Yellow, Green, Blue)
	5	5 stacks (red, Yellow, Green, Blue, White)
Supporter selection	L	 L type bracket (Standard type)
	E	 Elbow type supporter (EPM-18)
	M	 Plastic supporter (MP-60)
	S	 Plastic supporter (ST-011)



※ The color was arranged from top to bottom in following order, red, Yellow, Green, Blue, and White. There are two types of functions which are lighting only / Lighting, Flickering & Buzzer.

Base unit suffix code

Model	Code	Content
STE060 -	<input type="checkbox"/> <input type="checkbox"/> <input type="checkbox"/>	STE060 Sign Tower Base Unit
Classification	B	Base unit
Function	A	Lighting only
	F	Lighting, Flickering, Buzzer (external signal)
Power voltage	D51	24 V d.c.
	A11	100-240 V a.c. 50/60 Hz

LED unit suffix code

Model	Code	Content
STE060 -	<input type="checkbox"/> <input type="checkbox"/>	STE060 Sign Tower LED Unit
Classification	L	LED unit
	Unit	
	R	Red unit
	Y	Yellow unit
	G	Green unit
	B	Blue unit
	W	White unit

STE025 series

Specifications

Functions	Continuous light
Power voltage	24 V d.c.
Body material / color	ABS / Chrome plated & ivory
Lens colors	Red, green, yellow
Diameter	Ø 25
Max. number of stacks	3 Stacks

Suffix code

Model	Code	Content
STE025 -	<input type="checkbox"/> <input type="checkbox"/> <input type="checkbox"/>	Ø 25 LED Modular Sign Tower
Power voltage	D51	24 V d.c.
Number of stacks	1	1 stack (red)
	2	2 stacks (red, green)
	3	3 stacks (red, yellow, green)
Body color	S	Chrome plated
	N	Ivory



※ L type bracket sold separately

Sign Tower

Modular Sign Tower

New product Panel lamp

Wall mounting Indicator light

Rotating beacon

Warning light

HL series



NEW

Specifications

Model	HL-100	HL-200	HL-300
Appearance			
Optical characteristic specification			
Lens color	Transparency	Transparency	Transparency
Lighting color (default)	Daylight		
Color temperature (default)	6,000 ~ 7,000 K		
Total luminous flux	AC	509 lm	1044 lm
	DC	-	
Illuminance (at 1m)	AC	205 lux	318 lux
	DC	-	
Light efficiency	102 lm / W	109 lm/W	110 lm/W
General specification			
Model	HL-100	HL-200	HL-300
LED model used	LG Innotek G3 series (LEMWS59R80FZ) LM80 certification		
Features of the LED chip used	Zener diode is built into the internal circuit of the LED chip. ESD durability is strong through the protection circuit.		
Product life (based on LED)	More than 50,000 hours		
Rated voltage	AC	110-220 V a.c.	
	DC	12-24 V d.c.	
Frequency	50/60 Hz		
Operating voltage range	100-240 V a.c.		
Current consumption (A)	0.023		0.046
	-		
Power Consumption	5 W		10 W
	-		
Withstand voltage	AC : 3,000 V a.c., 60 Hz, 1 minute		
Color rendering	88	87	88
Responsibility			
Test Items	Exam conditions		Result
Withstand voltage	AC : 3,000 V a.c., 60 Hz, 1 minute		Clear
Operating temperature	-20 °C ~ +60 °C		Clear
ON/OFF repeated test	Turns off and repeats 1,000 times every 3 seconds		Clear
Aging Test	Operates over 96 hours with rated input		Clear
Acquisition standard			
Weight (g)	10.6	13	15

Suffix code

Model	Code	Content
HL	<input type="checkbox"/> <input type="checkbox"/> <input type="checkbox"/> - <input type="checkbox"/>	Universal panel lamp
Size and output	1 0 0	5 W
	2 0 0	10 W
	3 0 0	10 W
Input power method	A	110-220 V a.c.
	D	12-24 V d.c.

WALL MOUNTED LIGHTS

WME series

Specifications

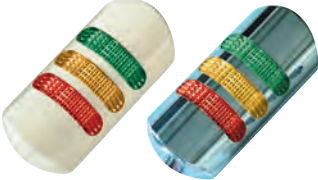
Model	WME
Appearance	
Function	● A : Lit indication, ● F : Lit, blinking, buzzer (selected by external signal)
Color (body)	● B : Beige body ● C : Chrome plated body
Rated voltage	24 V a.c. 50/60Hz or 24 V d.c. (Order specification when the power supply voltage is 12 V)
Number of stacked layers	3-stage
Power Consumption	2.1 W or less
Buzzer	2 Types of tones (single/intermittent), approx. 80 dB (1 m)

Suffix code

Model	Code	Content
WME-	<input type="checkbox"/> <input type="checkbox"/> <input type="checkbox"/>	Wall Mounted Light
Appearance	B	Beige color body
	C	Chrome gold plating body
Function	A	Continuous light indication
	F	Continuous light indication, flashing light indication, buzzer (selected by the external signal)
Power voltage	C51	24 V a.c. 50/60 Hz or 24 V d.c.
	C41	12 V a.c. 50/60 Hz or 12 V d.c. C41 ※ order-made

WMS series

Specifications

Model	WMS
Appearance	
Function	● A : Continuous light, ● F : Continuous light, Flashing light, Buzzer
Lens color	Red, Yellow, Green, Blue, White
Rated voltage	24 V a.c. 50/60 Hz or 24 V d.c. Common (Standard specification) (Order specification when the power supply voltage is 12 V)
Number of tiers	1, 2, 3, 4, 5 tiers
Power Consumption	0.5 W (lamp/1 stage), 3.2 W or less (including 5-stage buzzer)
Buzzer	2 types of tones (single/intermittent), 70 dB (1 m)

Suffix code

Model	Code	Content
WMS-	<input type="checkbox"/> <input type="checkbox"/> <input type="checkbox"/>	Wall Mounted Light
Appearance	A	Only for continuous light
	F	Continuous light, flashing light, buzzer (selected by the external signal)
Function	C51	24 V a.c. 50/60Hz or 24 V d.c.
	C41	12 V a.c. 50/60 Hz or 12 V d.c. Common ※ "C41" is an order specification
Power voltage	1	1 stack (red)
	2	2 stack (red, Green)
	3	3 stack (red, Yellow, Green)
	4	4 stack (red, Yellow, Green, Blue)
	5	5 stack (red, Yellow, Green, Blue, White)

T series

NEW

Specifications

Model	T060 / T084	T060 / T084	T060 / T084 T100 / T150	T060 / T084 / T100	T060 / T084 T100 / T150	T060 / T084 / T100
Appearance						
Appearance	Round cap supporter installation	Square cap supporter installation	Square cap direct installation	Round cap direct installation	Square cap direct installation	Round cap direct installation
Functions	Rotating continuous light				Rotating continuous light, buzzers	
Power voltage	● 12 V d.c. : 0.08 A, ● 24 V d.c. : 0.06 A, ● 110 - 220 V a.c. : 0.03 A				● 12 V d.c. : 0.09 A, ● 24 V d.c. : 0.07 A, ● 110 - 220 V a.c. : 0.04 A	
Rotating cycle	180 ± 15% times / 1 minute					
Buzzer volume	-				Approx. 80 dB	
Cap materials	Polycarbonate (PC) resin					
Body	ABS resin					
Cap colors	Red, yellow, green, blue					
Degree of protection	IP54					

Sign Tower

Modular Sign Tower

New product Panel lamp

Wall mounting Indicator light

Rotating beacon

Warning light

Suffix code

Model	Code	Content
T	□ - □ □ □ □ □ □	Revolving Warning Light
Appearance	060	Ø 60
	084	Ø 84
	100	Ø 100
	150	Ø 150
Cap appearance	P	Round cap ✖ except ø150 model
	F	Square cap attachment type
Functions	A	Rotating lights
	F	Rotating light · Buzzer
Power voltage	D12	12 V d.c.
	D24	24 V d.c.
	A11	110 - 220 V a.c.
Cap colors	R	Red
	Y	Yellow
	G	Green
	A	Blue (only with Ø 84 model)
Pedestal	D	Direct installation type (basic type)
	M	Supporter installation type ✖ only with Ø60/ Ø84 models with rotating continuous light

WARNING LIGHTS

RLA-WX/WXB CE

Specifications

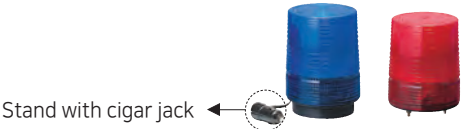

Model	RLA-WX□□	RLA-WXB□□
Appearance		
Function	Rotating continuous light	Rotating continuous light, buzzer
Dimension	Ø118 Square cap (direct installation, magnetic mounting bracket, magnetic mounting bracket and cigar jack)	
Power voltage	12 V d.c., 24 V d.c., 110 V a.c. 50/60 Hz, 220 V a.c. 50/60 Hz	
Power consumption	● 7.2 W (Power voltage : at 24 V d.c.), ● 12 W (Power voltage : at 220 V a.c.)	
Flash speed	About 60 times / 1 minute	
Light source	Xenon tube strobe light	
Buzzer	-	Built-in buzzer (approx. 90 dB 1m apart)
Material	● Cap : Acrylic resin, ● Body : ABS resin	
Cap color	Red, blue, white	
Protection structure	IP54 (IEC 60529)	

Suffix code

Model	Code	Content	
RLA-	□ □ □	Turn Light (Ø118)	
Function	WX	Strobe light	
	WXB	Rotating continuous light and buzzer built-in	
Power voltage	01	12 V d.c.	
	02	24 V d.c.	
	10	110 V a.c.	※ Direct installation type
	20	220 V a.c.	
	10M	110 V a.c.	※ Permanent magnet stand
	20M	220 V a.c.	
	01A	12 V d.c.	※ Permanent magnet stand with cigar jack for automobile
	02A	24 V d.c.	
Cap color	R	Red	
	B	Blue	

LT series

Specifications

Appearance	Suffix code	Power voltage	Power consumption	Number of leds	Rotating cycle	Flickering
	LT-R-12	12-48 V d.c., 12-24 V a.c. 50/60 Hz	Max. 2.9 W (power voltage: 12 - 48 V d.c.)	24	Approx. 90 times / min	Approx. 50 times / min
	LT-R-012	110/220 V a.c. 50/60 Hz	Max. 5 W	24		
	LT-P-12	12-48 V d.c., 12-24 V a.c. 50/60 Hz	Max. 2.9 W (power voltage: 12 - 48 V d.c.)	24		
	LT-P-012	110/220 V a.c. 50/60 Hz	Max. 5 W	24		
	LT-PB-12	12-48 V d.c., 12-24 V a.c. 50/60 Hz	Max. 2.9 W (power voltage: 12 - 48 V d.c.)	24		
	LT-PB-012	110/220 V a.c. 50/60 Hz	Max. 5 W	24		

Sign Tower

Modular
Sign TowerNew product
Panel lampWall mounting
Indicator lightRotating
beacon

Warning light

Suffix code

Model	Code	Content
LT-	<input type="checkbox"/> <input type="checkbox"/> <input type="checkbox"/>	Signal Light (Ø84 Cap)
Installation type (Function)	R	Supporter mounting (rotating, flashing)
	P	Direct mounting (rotating, flashing)
	PB	Direct mounting (rotating, flashing, buzzer built-in)
Power voltage	12	12-48 V d.c., 12-24 V a.c. 50/60 Hz
	012	110/220 V a.c. 50/60 Hz
Cap color	R	Red
	Y	Yellow
	G	Green

SLB series

Specifications

Model	SLB 060
Appearance	
Dimensions (cap size)	Ø 70 Cap
Shape and function	<ul style="list-style-type: none"> ● P : Direct installation of round cap , ● R : Installation with round cap base, ● F : Direct installation of square cap, ● X : Installation with square cap base
Function	● A : Lighting only ● F : Lit, blinking, buzzer (selected by external input signal)
Rated voltage	24 V a.c. 50/60 Hz or 24 V d.c., 110 - 240 V a.c. 50/60 Hz (Order specification when the power supply voltage is 12 V)
Color	Red, Yellow, Green
Light	LED (Light-emitting diode)
Power consumption	Max. 2 W (24 V a.c. / d.c.), max. 3.5 W (110 - 240 V a.c.)
Buzzer	● 2 types of buzzer melodies (single melody, beeping), ● volume : 80 dB (1 m distance)





Suffix code

Model	Code	Content
SLB	<input type="checkbox"/> - <input type="checkbox"/> <input type="checkbox"/> <input type="checkbox"/>	Turn Light
Dimension	060	Ø 70 Cap
Design and function	RA	Round type cap supporter mounting installation
	XA	Rectangular type cap supporter mounting installation
	PA	Round type cap direct installation
	FA	Rectangular type cap direct installation
	PF	Round type cap direct installation
Power voltage	C51	24 V a.c. 50/60 Hz or 24 V d.c.
	C41	12 V a.c. 50/60 Hz or 12 V d.c. (※ order-made)
	A11	110 - 240 V a.c. 50/60 Hz
Cap color	R	Red
	Y	Yellow
	G	Green

BUZZERS

HY-256/306/606/606N

Specifications



Model	HY-256	HY-306	HY-606	HY-606N
Appearance				
Voltage used	110 V a.c., 220 V a.c. 12 V d.c., 24 V d.c.			
Power consumption	Approx. 4 VA : HY-256-1, HY-256-2, HY-306-1, HY-306-2 30 mA Max.: HY-256-12, HY-256-24, HY-306-12, HY-306-24		Approx. 8 VA : HY-606-1, HY-606N-1, HY-606-2, HY-606N-2 30 mA Max.: HY-606-12, HY-606N-12, HY-606-24, HY-606N-24	
Power frequency	50/60 Hz (for 110 V a.c., 220 V a.c.)			
Volume	85 dB (1 m) * HY-606-12, HY-606N-12, HY-606-24, HY-606N-24: 80 dB (1 m)			
External diameter	For Ø25	For Ø30	Rectangular panel flush (for Ø66)	Rectangular panel extended (□80)

Suffix code

Model	Code	Content
HY-	<input type="checkbox"/> <input type="checkbox"/>	Power Buzzer
Dimension	256	For Ø 25
	306	For Ø 30
	606	Rectangular panel flush (for Ø 66)
	606N	Rectangular panel extended (□80)
Power supply voltage	1	110 V a.c. 50/60 Hz
	2	220 V a.c., 50/60 Hz
	12	12 V d.c.
	24	24 V d.c.

HY-606MD/606MA

Specifications



Model	HY-606MD	HY-606MA
Dimension		
Power supply voltage	12 / 24 V d.c.	110 / 240 V a.c.
Power consumption	Approx. 2.5 W	
Power frequency	-	50/60 Hz (Common)
Volume	98 dB max (1 m)	
External diameter	Ø 66 panel cutout dimensions	

Suffix code

Model	Code	Content
HY-606	<input type="checkbox"/>	4-Tone melody buzzer
Power supply voltage	MD	12 / 24 V d.c.
	MA	110 / 220 V a.c.

HY-226M/256

Specifications

Model	HY-226MD/MA	HY-256MD/MA
Dimension		
Power supply voltage	100-240 V a.c. 50/60 Hz / 12 V d.c., 24 V d.c.	100-240 V a.c. 50/60 Hz / 12 V d.c., 24 V d.c.
Power consumption	0.6 W / 13.5 W	0.6 W / 13.5 W
Power frequency	50/60 Hz	50/60 Hz
Volume	80 dB	80 dB
External diameter	Ø22 / Ø25	Ø25

Suffix code

Model	Code	Content
HY-	<input type="checkbox"/> <input type="checkbox"/>	3-Tones Electronic Buzzer
Dimension	226	Ø 22 / Ø 25 dual usage (Front side: rectangular type)
	256	Ø 25 (front side: round type)
Power supply voltage	MD	12-24 V d.c.
	MA	100-240 V a.c. 50/60 Hz

HYBT/HYTM series

NEW

Specifications

Classification	Model	HYTM-15A	HYBT-15A2	HYTM-25A	HYTM-35A	HYTM-60A	HYTM-100A
Rated insulating voltage		600 V					
Rated current		15A	15A	25A	35A	60A	100A
Insulation resistance		Min. 100 MΩ (between each live part and between each live part and mounting metal plate)					
Dielectric strength		2500 V a.c. for 1 min (between live part and unfilled part)					
Terminal bolt		M3.5	M3.5	M4	M4	M6	M6
Ambient temperature & humidity		-20 ~ 55 °C, 45 ~ 85 % RH					

Strong/
4 tones melody/
3-tone
electronic
buzzer

New product
Prefabricated
Terminal block

New product
Stationary
Terminal block

Fuse holder

Rolled steel
Control box

Cable
Connector

External dimensions

Model	Appearance	External dimensions
HYTM-15A		
HYBT-15A2		
HYTM-25A		
HYTM-35A		
HYTM-60A		
HYTM-100A		

Separator

Model	Appearance	External dimensions
HYTM-02 (15A, 25A)		
HYTM-04 (35A)		
HYTM-05 (60A)		
HYTM-06 (100A)		
HYBT-12 (HYBT-15A2-A)		
HYBT-12 (HYBT-15A2-B)		





Accessories

Applying Accessory Classification

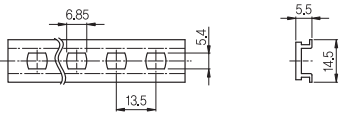

Model	HYTM-15A	HYBT-15A2	HYTM-25A	HYTM-35A	HYTM-60A	HYTM-100A
Rail	HYBT-01					
Separator	HYTM-02	HYBT-12	HYTM-02	HYTM-04	HYTM-05	HYTM-06
Stopper	HYBT-07					
Terminal number plate	HYTM-08	HYBT-08	HYTM-08			
Terminal number plate cover	HYTM-07	HYBT-10	HYTM-07			
Short terminal	HYBT-13	HYBT-13	-	-	-	-

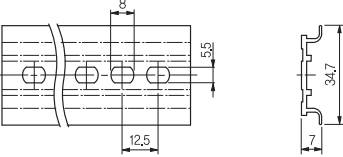
ASSEMBLING TERMINAL BLOCKS

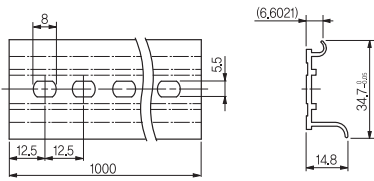

● Aluminum Rail (DIN rail)

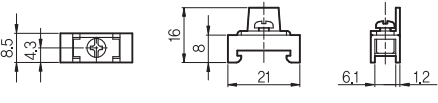
Appearance	External dimensions
 <p>HYBT-CH10 (For 10A)</p>	
 <p>HYBT-01 (For 15A ~ 100A)</p>	
 <p>HYBT-01A (For warp 15 A ~ 100 A)</p>	

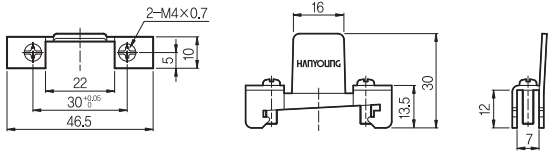

● Stopper

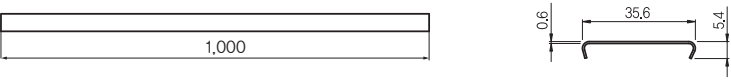
Model	Appearance	External dimensions
HYBT-ST10		
HYBT-07		

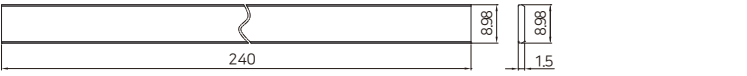

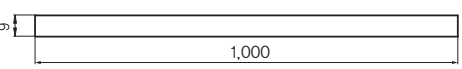

● Terminal number plate cover

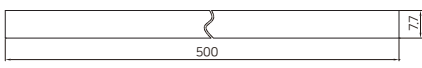
Model	Appearance	External dimensions
HYBT-08 ※ For HYBT-15A2		
HYTM-08		

● Seal

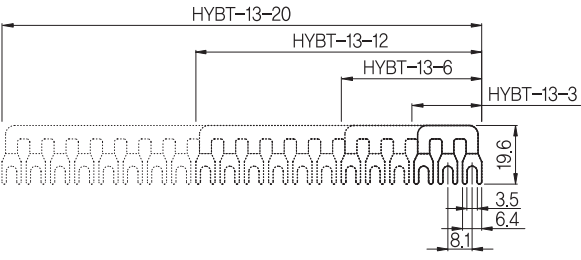
Model	Appearance	External dimensions
HYBT-10 (9 mm Width) ※ For HYBT-15A2		
HYTM-07 (7.7 mm Width)		

● Short Bar

Appearance	External dimensions
 <p>HYBT-13-3</p>	
 <p>HYBT-13-6</p>	
 <p>HYBT-13-12</p>	
 <p>HYBT-13-20</p>	

※ Short bar HYBT-13-3~13-20 are only for the HYBT-15A

HYT series

NEW

● For rated current 10 A

Model	Appearance	Rating	Horizontal	Width	Height	Fixed dimensions
HYT-1010		10A 10P	112	24	17	102.5

● For rated current 20 A

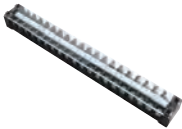
Model	Appearance	Rating	Horizontal	Width	Height	Fixed dimensions
HYT-203		20A 3P	56	30	20	44
HYT-204		20A 4P	68	30	20	56
HYT-206		20A 6P	89	30	20	78
HYT-2010		20A 10P	137	30	20	126
HYT-2012		20A 12P	163	30	20	150.5
HYT-2015		20A 15P	199	30	20	187
HYT-2020		20A 20P	257	30	20	245

● For rated current 30 A

Model	Appearance	Rating	Horizontal	Width	Height	Fixed dimensions
HYT-303		30A 3P	67	5	24	54.5
HYT-304		30A 4P	83	35	24	70
HYT-306		30A 6P	113	35	24	100.5
HYT-3010		30A 10P	153	35	24	143

● For rated current 60 A

Model	Appearance	Rating	Horizontal	Width	Height	Fixed dimensions
HYT-603		60A 3P	84.5	40	31	28
HYT-604		60A 4P	113.5	40	31	57

● For rated current 100 A

Model	Appearance	Rating	Horizontal	Width	Height	Fixed dimensions
HYT-1003		100A 3P	104.5	55.5	36.5	35
HYT-1004		100A 4P	140	55.5	36.5	70

● For rated current 150 A

Model	Appearance	Rating	Horizontal	Width	Height	Fixed dimensions
HYT-1503		150A 3P	115.5	67.5	41	39
HYT-1504		150A 4P	153	67.5	41	77

● For rated current 200 A

Model	Appearance	Rating	Horizontal	Width	Height	Fixed dimensions
HYT-2003		200A 3P	134	72.5	44.5	45
HYT-2004		200A 4P	180	72.5	44.5	90

● For rated current 300 A

Model	Appearance	Rating	Horizontal	Width	Height	Fixed dimensions
HYT-3003		300A 3P	155.5	83.5	49.5	51.8
HYT-3004		300A 4P	207.5	83.5	49.5	103.6

● For rated current 400 A

Model	Appearance	Rating	Horizontal	Width	Height	Fixed dimensions
HYT-4003		400A 3P	155.5	83.5	49.5	51.8
HYT-4004		400A 4P	207.5	83.5	49.5	103.6

● For rated current 500 A

Model	Appearance	Rating	Horizontal	Width	Height	Fixed dimensions
HYT-5003		500A 3P	204	94	59.5	68
HYT-5004		500A 4P	270	93	59.5	136

Strong/
4 tones melody/
3-tone
electronic
buzzer

New product
Prefabricated
Terminal block

New product
Stationary
Terminal block

Fuse holder

Rolled steel
Control box





Cable
Connector

FIXING TYPE TERMINAL BLOCKS

HY-F15/F30 series

UPGRADE

Specifications

Model	F15-1A	F15-1D	F15-2A	F15-2D	F15-3A	F15-3D	F30
Appearance							
Rated current	250 V a.c. 15 A	24 V d.c. 10 A	250 V a.c. 15 A	24 V d.c. 10 A	250 V a.c. 15 A	24 V d.c. 10 A	30 A 600 V a.c.
Remarks	AC 110-220 V a.c. DC 12-24 V d.c. ※ For Ø 6 X 30 mm ceramic fuses						110-600 V a.c. ※ For Ø 12 X 50 mm ceramic fuses

HY-25/30 series

UPGRADE

Specifications

Appearance	Model	Materials	Remarks
	HY-2501	Rolled iron	Ø 25
	HY-2502		
	HY-2503		
	HY-2504		
	HY-2505		
	HY-2506		
	HY-3001	Rolled iron	Ø 30
	HY-3002		
	HY-3003		
	HY-3004		
	HY-3005		
	HY-3006		

Suffix code

Model	Code	Content
HY-	<input type="checkbox"/> <input type="checkbox"/>	Rolled Iron Control Boxes
Installation hole	25	Ø 25 installation hole
	30	Ø 30 installation hole
Number of holes	01	1 Hole
	02	2 Hole (03 : 3 Hole, 04 : 4 Hole, 05 : 5 Hole, 06 : 6 Hole)

HYC-M1/M2

Suffix code

Appearance	Model	Material	Remarks
	HYC-M1	Polycarbonate (PC)	Ø8
	HYC-M2	Polycarbonate (PC)	Ø11

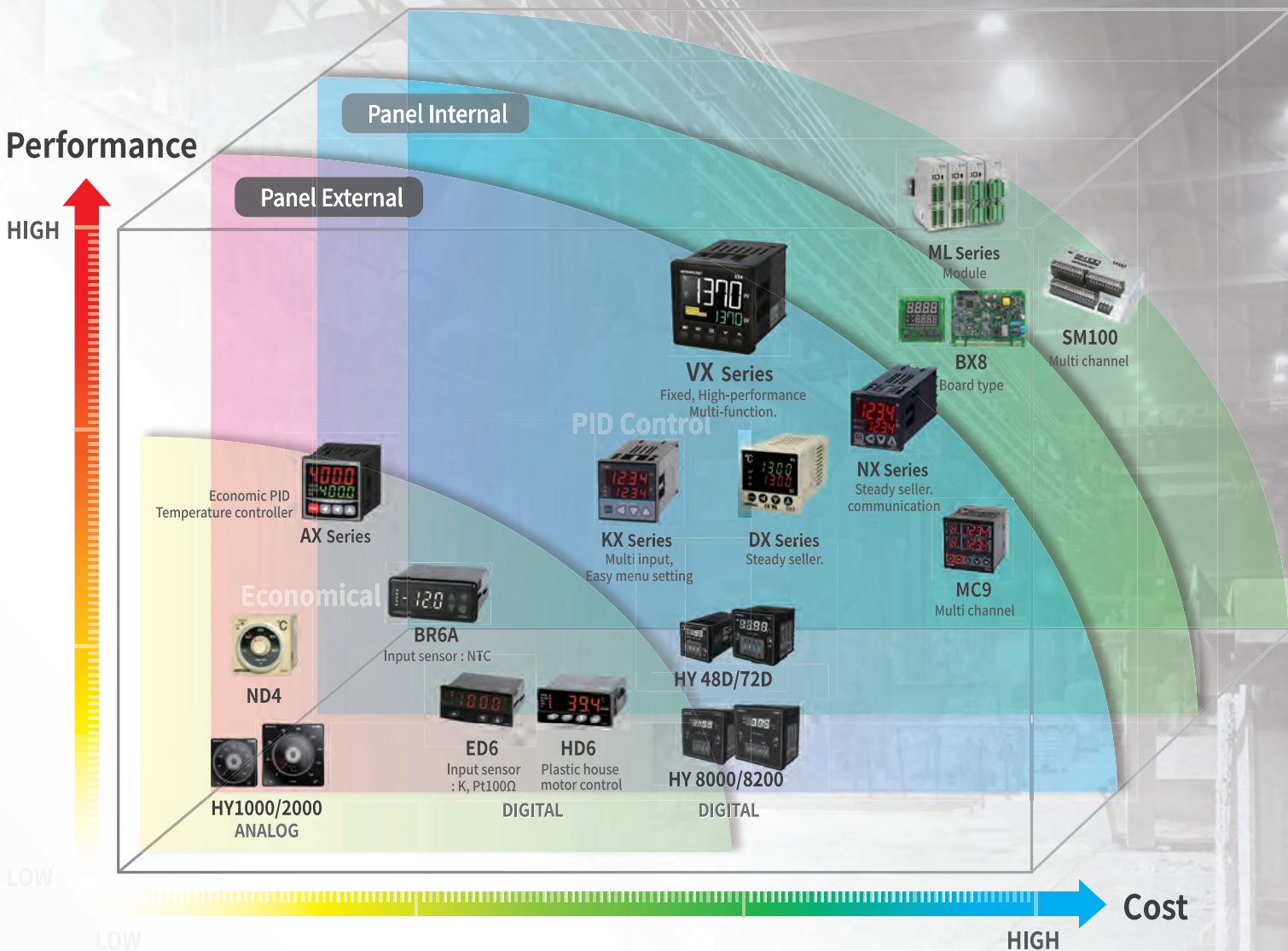

thermo-hygrostat

TH510/300



Programmable temperature & Humidity controller

TD510/300



Programmable temperature controller

TS510



Thermal shock test controller

Programmable

NP200



Programmable temperature controller

mold temperature

MT100



Multi-input mold temperature controller

Recorder

RT9N



mini recorder

GR200A



Graphic recorder (touch panel)

input device

EE99



High-precision temperature/humidity sensor

output device

SSR



solid state relay

TPR



power regulator

Power supply

TPS



Power supply

DPS



DIN rail power supply

Other device

FS3A



water level regulator

HYER3



Electrode holder

CV250



Temperature/humidity converter

HMCE103



Ethernet Converter

CV310



converter for communication

TCS



Integrated program

indicator

BK3



Digital Temperature Indicators

BK6-M



Multi Input Temperature Indicators

HANYOUNG nux

MAIN PRODUCTS

Temperature controllers / Recorders / Counters / Timers / Panelmeters / Multi pulse meters / Proximity sensors / Photo sensors / Rotary encoders / Thyristor power regulators / Solid state relays / Power supplies / Control switches / Combination display lights / Power switches / Main switches / Cam switches / Limit switches / Micro switches / Pendant switches / Foot switches / Mono lever switches / Sign towers / Turn lights / Buzzers / Terminal blocks / Fuse holders / Control boxes / Connector cables

HANYOUNG nux

HANYOUNG NUX CO.,LTD.

28, Gilpa-ro 71 beon-gil, Nam-gu, Incheon, Korea

Tel : +82-32-876-4697 Fax : +82-32-876-4696

E-mail : overseas@hynux.com

※ The information contained in this catalogue may change without prior notice for upgrade purposes.